

S P E C F I L E



Product Number : **PT-VX500**

Product Name : LCD Projector

Specifications

Main unit

Power supply		100–240 V AC, 50/60 Hz
Power consumption		365 W (0.3 W when STANDBY MODE set to ECO,* ¹ 11.5 W when STANDBY MODE set to NETWORK.)
LCD panel	Panel size	16.0 mm (0.63 inches) diagonal (4:3 aspect ratio)
	Display method	Transparent LCD panel (× 3, R/G/B)
	Pixels	786,432 (1,024 × 768) × 3, total of 2,359,296 pixels
	Pixel configuration	Stripe
Lens		Manual zoom (1.6×), manual focus, F 1.60–2.12, f 15.28–24.62 mm
Throw ratio		1.18–1.90:1
Lamp		280 W UHM lamp
Screen size		0.76–7.62 m (30–300 inches) diagonally, 16:10 aspect ratio
Colors		Full color (16,777,216 colors)
Brightness* ²		5,000 lumens (LAMP POWER: NORMAL)
Center-to-corner uniformity* ²		85%
Contrast* ²		4,000:1 (full on/off, LAMP POWER: NORMAL, with iris on)
Resolution		1,024 × 768 pixels (Input signals that exceed this resolution will be converted to 1,024 × 768 pixels.)
Scanning frequency	HDMI	f _H : 25 kHz–80 kHz, f _V : 50 Hz–85 Hz, dot clock: 162 MHz or lower
	RGB	f _H : 15 kHz–100 kHz, f _V : 50 Hz–100 Hz, dot clock: 140 MHz or lower (Signals above 140 MHz are downsampled.)
	YPbPr (YCbCr)	480i (525i): f _H 15.75 kHz; f _V 60 Hz, 576i (625i): f _H 15.63 kHz; f _V 50 Hz, 480p (525p): f _H 31.50 kHz; f _V 60 Hz, 576p (625p): f _H 31.25 kHz; f _V 50 Hz, 720 (750)/60p: f _H 45.00 kHz; f _V 60 Hz, 720 (750)/50p: f _H 37.50 kHz; f _V 50 Hz, 1080 (1125)/60i: f _H 33.75 kHz; f _V 60 Hz, 1080 (1125)/50i: f _H 28.13 kHz; f _V 50 Hz
	Video/S-Video	f _H : 15.75 kHz, f _V : 60 Hz [NTSC/NTSC4.43/PAL-M/PAL60] f _H : 15.63 kHz, f _V : 50 Hz [PAL/PAL-N/SECAM]
Optical axis shift		Vertical: +40% (manual)
Keystone correction range		Vertical: ±30° (±20° with Real-Time Keystone Correction)
Installation		Ceiling/desk, front/rear (menu selection)
Built-in speaker	Size	4 cm (1-9/16 inches) (round) × 1
	Output power	10 W (monaural)
Terminals	HDMI IN	HDMI 19-pin × 1, HDCP compatible 480p (525p), 576p (625p), 720 (750)/60p, 720 (750)/50p, 1080 (1125)/60i, 1080 (1125)/50i, 1080 (1125)/60p, 1080 (1125)/50p VGA (640 × 480)–WUXGA* ³ (1,920 × 1,200), audio signal: linear PCM (sampling frequencies: 48 kHz, 44.1 kHz, 32 kHz)
	COMPUTER (RGB) 1 IN R, G, B	D-sub HD 15-pin (female) × 1 G: 0.7 Vp-p (1.0 Vp-p for sync on G), 75 ohms; B, R: 0.7 Vp-p, 75 ohms; HD/VD, SYNC: high impedance, TTL (positive/negative) NOTE: SYNC/HD and VD terminals do not accept tri-level sync signals.
	Y, Pb (Cb), Pr (Cr)	Y: 1.0 Vp-p (including sync signal); Pb (Cb), Pr (Cr): 0.7 Vp-p, 75 ohms
	COMPUTER (RGB) 2 IN / 1 OUT R, G, B	D-sub HD 15-pin (female) × 1 (input/output selectable using on-screen menu.) G: 0.7 Vp-p (1.0 Vp-p for sync on G), 75 ohms; B, R: 0.7 Vp-p, 75 ohms; HD/VD, SYNC: high impedance, TTL (positive/negative) NOTE: SYNC/HD and VD terminals do not accept tri-level sync signals.

VIDEO IN	RCA pin × 1, 1.0 Vp-p, 75 ohms
S-VIDEO IN	Mini DIN 4-pin × 1, Y: 1.0 Vp-p; C: 0.286 Vp-p, 75 ohms
COMPUTER AUDIO IN 1	M3 (L, R) × 1, 0.5 Vrms
COMPUTER AUDIO IN 2 / MIC IN	M3 (L, R) × 1, 0.5 Vrms
VIDEO/S-VIDEO AUDIO IN	RCA × 2 (L/R × 1), 0.5 Vrms
AUDIO OUT	M3 (L, R) × 1 (monitor out: 0–2.0 Vrms, variable)
SERIAL IN	D-sub 9-pin (female) × 1, for external control (RS-232C compliant)
LAN	RJ-45 × 1, for network connection, 100Base-TX/10Base-T, compliant with PLink™
Power cord length	2.0 m (6 ft 7 in)
Cabinet materials	Molded plastic
Dimensions (W × H × D)	379 mm × 107 mm* ⁴ × 305 mm* ⁵ (14-29/32 × 4-7/32* ⁴ × 12* ⁵ inches)
Weight	Approximately 4.8 kg (10.6 lbs)
Operation noise	37 dB (LAMP POWER: NORMAL), 29 dB (LAMP POWER: ECO)
Operating temperature	0–40 °C (32–104 °F)
Operating humidity	20%–80% (no condensation)
Remote control unit	
Power supply	3 V DC (R03/LR03/AAA type battery × 2)
Operation range* ⁶	Approximately 7 m (23 ft) when operated from directly in front of the signal receptor
Dimensions (W × H × D)	52 × 110 × 18 mm (2-1/16 × 4-11/32 × 23/32 inches)
Weight	Approx. 67 g (2.4 oz) (including batteries)
Supplied accessories	
	Power cord (× 1) (× 2 for PT-VX500EA)
	AC power cord holder (× 1)
	Wireless remote control unit (× 1)
	Batteries for remote control (R03/LR03/AAA type × 2)
	Carrying bag (× 1)
	Computer cable (1.8 m (5 ft 11 in), for VGA) (× 1)
	Software CD-ROM (Logo Transfer Software, Multi Projector Monitoring and Control Software) (× 1)
Optional accessories	
Replacement lamp unit	ET-LAV200
Replacement filter unit	ET-RFV200
Ceiling mount bracket	ET-PKV100H (for high ceilings) ET-PKV100S (for low ceilings)
Bracket assembly	ET-PKV200B

Weights and dimensions shown are approximate. Specifications subject to change without notice.

- *1 When the STANDBY MODE is set to ECO, network functions such as power on over the LAN network will not operate. Also, only certain commands can be received for external control using the serial terminal.
- *2 Measurement, measuring conditions, and method of notation all comply with ISO 21118 international standards.
- *3 WUXGA resolution is supported only when the signals are compliant with VESA CVT-RB (Coordinated Video Timing-Reduced Blanking).
- *4 With legs at shortest position.
- *5 Protruding parts not included.
- *6 Operation range differs depending on environments.

Dimensions

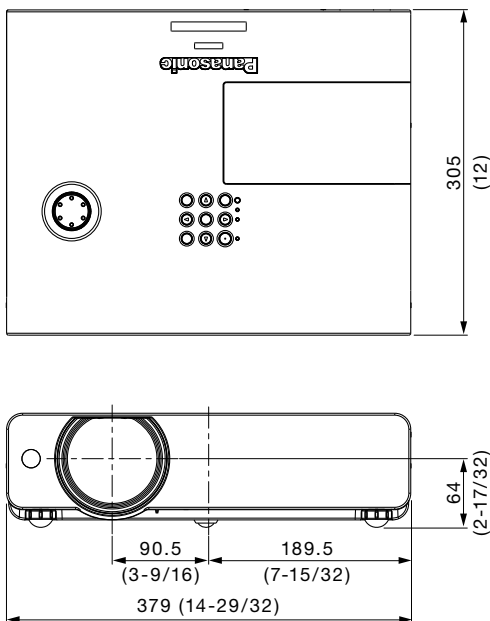

unit : mm (inch)

NOTE: This illustration is not drawn to scale.

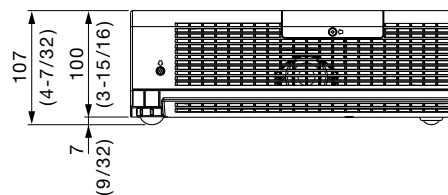

Terminals

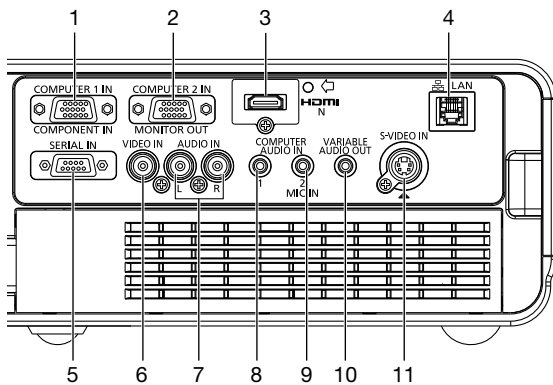

- 1 Computer 1 input
- 2 Computer 2 input / computer 1 output
- 3 HDMI input
- 4 LAN connector
- 5 Serial input
- 6 Video input
- 7 Audio input for video/S-Video
- 8 Audio input for computer 1
- 9 Audio input for computer 2 / mic input
- 10 Audio output
- 11 S-Video input

Standard setting-up position

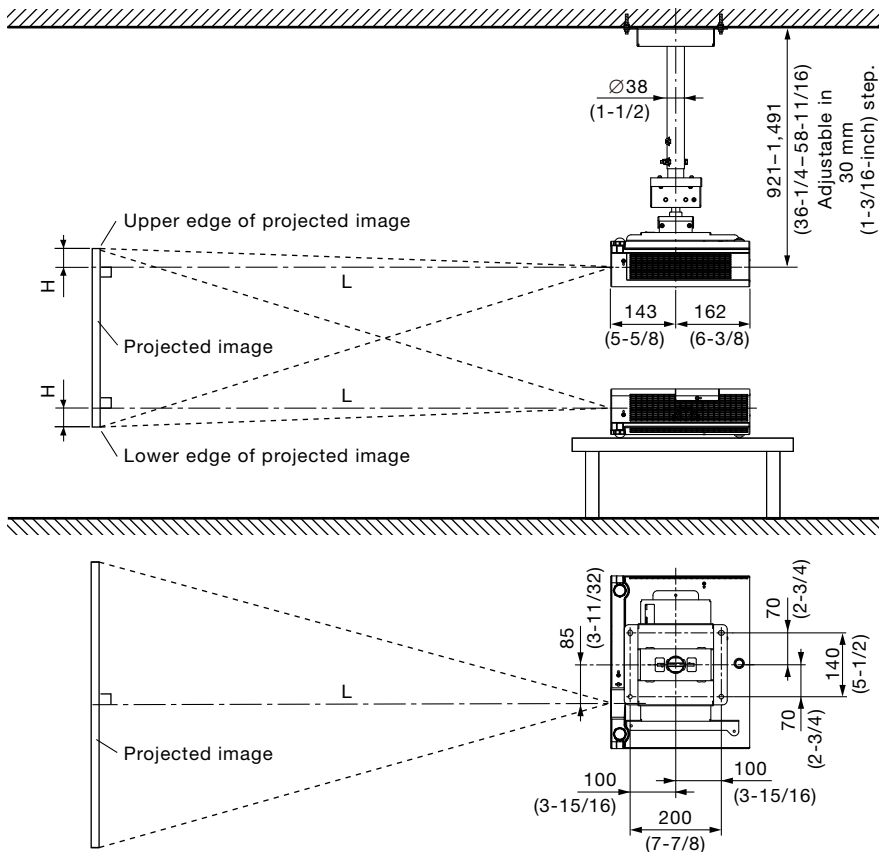

NOTE:

Illustrations show the projector installed using optional ceiling mount bracket ET-PKV100H and bracket assembly ET-PKV200B.

This illustration is not drawn to scale.

unit : mm (inch)

Caution:

- All construction work should be done by a qualified technician.
- When mounting to the ceiling, use the special mounting bracket. To prevent the projector from swaying or dropping, attach the wire that is included with the projector between the mounting bracket and the ceiling.

Projection distance for 4:3 aspect ratio screen

unit: meters (feet)

Projection size [diagonal]	Projection distance [L]		Height from the edge of screen to center of lens [H]
	Min [wide]	Max [telephoto]	
0.76 m / 30"	0.7 (2.3)	1.1 (3.6)	0.05 – 0.23 (0.16 – 0.75)
1.02 m / 40"	0.9 (3.0)	1.5 (4.9)	0.06 – 0.31 (0.20 – 1.02)
1.27 m / 50"	1.2 (3.9)	1.9 (6.2)	0.08 – 0.38 (0.26 – 1.25)
1.52 m / 60"	1.4 (4.6)	2.3 (7.5)	0.09 – 0.46 (0.30 – 1.51)
1.78 m / 70"	1.7 (5.6)	2.7 (8.9)	0.11 – 0.53 (0.36 – 1.74)
2.03 m / 80"	1.9 (6.2)	3.1 (10.2)	0.12 – 0.61 (0.39 – 2.00)
2.29 m / 90"	2.2 (7.2)	3.5 (11.5)	0.14 – 0.69 (0.46 – 2.26)
2.54 m / 100"	2.4 (7.9)	3.9 (12.8)	0.15 – 0.76 (0.49 – 2.49)
3.05 m / 120"	2.9 (9.5)	4.7 (15.4)	0.18 – 0.91 (0.59 – 2.99)
3.81 m / 150"	3.6 (11.8)	5.8 (19.0)	0.23 – 1.14 (0.75 – 3.74)
5.08 m / 200"	4.8 (15.7)	7.8 (25.6)	0.31 – 1.52 (1.02 – 4.99)
6.35 m / 250"	6.0 (19.7)	9.7 (31.8)	0.38 – 1.91 (1.25 – 6.27)
7.62 m / 300"	7.2 (23.6)	11.7 (38.4)	0.46 – 2.29 (1.51 – 7.51)

NOTE:

- The value for L (distance to screen) varies slightly depending on the zoom lens characteristics.
- At the shortest projection distance, the zoom lens characteristics may cause slight image distortion.

Calculation of the projection distance

For a screen size different from the above, use the equation below to calculate the projection distance.

Aspect ratio 4:3

minimum $L (m) = (\text{diagonal screen size in inches}) \times 0.0243 - 0.0294$

maximum $L (m) = (\text{diagonal screen size in inches}) \times 0.0391 - 0.0319$

NOTE:

Distances calculated with the above equations will include a slight error.

Shift range

Optical axis shift function allows to shift the position of a projected image as shown below.

• **Floor mount**

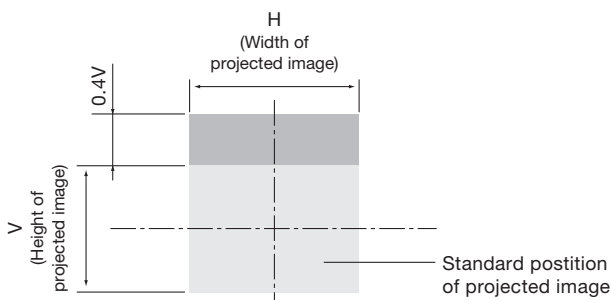

• **Ceiling mount**

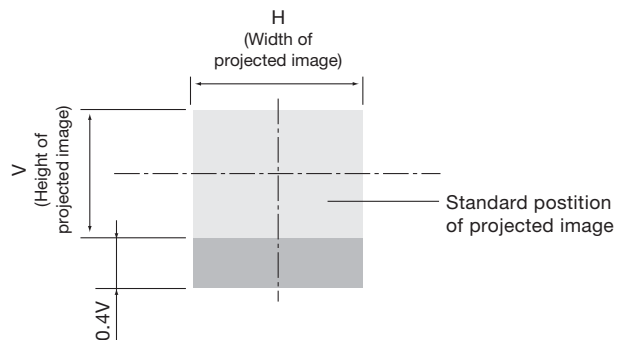

Installable angle

Install the projector at an angle within the range shown below.

• **Vertical direction**

The projector may be installed at a vertical angle of 30°.

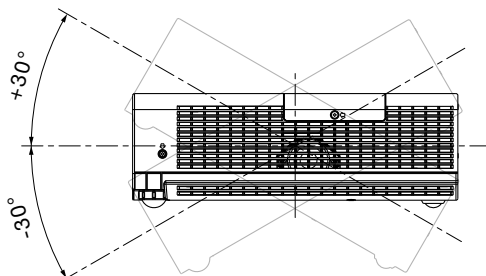

• **Horizontal direction**

The projector may be installed at a horizontal angle of 15°.

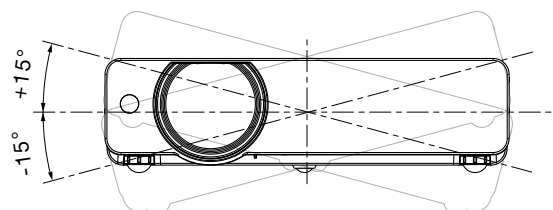

List of compatible signals

The signals that can be input to this projector are shown in the table below. Horizontal scanning frequencies of 25 kHz to 80 kHz (15 kHz to 100 kHz for RGB signals), vertical scanning frequencies of 50 Hz to 120 Hz (50 Hz to 100 Hz for RGB signals), and a dot clock of 162 MHz maximum (140 MHz maximum for RGB signals) can be input.

NOTE: The native resolution of this projector is 1,024 × 768 pixels. If the display resolution of the input signal is different from the native resolution, image compression or expansion will be used to convert the input signal to a level within the native resolution.

Display mode	Display resolution (dots)*1	Scanning frequency		Dot clock frequency (MHz)	Format
		H (kHz)	V (kHz)		
NTSC/NTSC4.43/PAL-M/PAL60	720 × 480i	15.7	59.9	–	VIDEO/S-VIDEO
PAL/PAL-N/SECAM	720 × 576i	15.6	50.0	–	
480i (525i)	640 × 480i	15.7	59.9	12.3	YPbPr/RGB
576i (625i)	768 × 576i	15.6	50.0	14.8	
480p (525p)	640 × 480	31.5	59.9	25.2	HDMI/YPbPr/RGB
576p (625p)	768 × 576	31.3	50.0	29.5	
720p	1280 × 720	45.0	60.0	74.3	
		37.5	50.0	74.3	
1035i	1920 × 1035i	33.8	60.0	74.3	
1080i	1920 × 1080i	33.8	60.0	74.3	
		28.1	50.0	74.3	
VGA	640 × 400	31.5	70.1	25.2	RGB
	640 × 480	31.5	59.9	25.2	HDMI/RGB
		37.5	75.0	31.5	RGB
		37.9	72.8	31.5	
		37.9	74.4	31.5	
		43.3	85.0	36.0	
	720 × 400	31.5	70.1	28.3	
MAC LC13	640 × 480	35.0	66.6	31.3	
MAC13		35.0	66.7	30.2	
SVGA	800 × 600	32.7	51.1	32.7	
		34.5	55.4	36.4	
		35.2	56.3	36.0	
		37.9	60.3	40.0	
		37.9	61.0	40.0	
		38.0	60.5	40.1	
		38.6	60.3	38.6	
		46.9	75.0	49.5	
		48.1	72.2	50.0	
		53.7	85.1	56.3	
MAC16	832 × 624	49.7	74.6	57.3	
XGA	1024 × 768	44.0	54.6	59.1	
		46.9	58.2	63.0	
		47.0	58.3	61.7	
		48.4	60.0	65.0	HDMI/RGB
		48.5	60.0	65.2	RGB
		58.0	72.0	74.7	
		60.0	75.0	78.8	HDMI/RGB
		60.3	74.9	79.3	
		61.0	75.7	81.0	RGB
		62.0	77.1	84.3	
		63.5	79.4	83.4	
		56.5	70.1	75.0	HDMI/RGB
		68.7	85.0	94.5	
	1024 × 768i	36.0	87.2	47.3	RGB
		35.5	87.0	44.9	
MAC19	1024 × 768	60.2	75.1	80.0	

*1 The "i" appearing after the resolution indicates an interlaced signal.

Display mode	Display resolution (dots)*1	Scanning frequency		Dot clock frequency (MHz)	Format	
		H (kHz)	V (kHz)			
WXGA	1280 × 768	47.8	59.9	79.5	HDMI/RGB	
		60.3	74.9	102.3		
		68.6	84.8	117.5		
	1280 × 800	41.2	50.0	68.6	RGB	
		49.6	60.1	79.4		
		49.7	59.8	83.5		
		56.0	70.0	95.0		
		57.6	72.0	97.8		
		58.2	70.0	98.9		
		60.0	72.0	102.8		
		62.8	74.9	106.5		
	1360 × 768	63.9	60.0	108.0	HDMI/RGB	
		71.5	84.8	122.5	RGB	
	MAC21	1152 × 870	47.7	60.0	86.7	RGB
			56.2	72.0	86.7	
48.4			60.0	100.1		
SXGA	1152 × 900	48.4	60.0	86.7	HDMI/RGB	
		61.2	65.2	92.0		
		71.4	75.6	105.1		
	1280 × 960	61.9	66.0	94.5	RGB	
		60.0	60.0	108.0		
	1280 × 1024	62.5	58.6	108.0	HDMI/RGB	
		63.3	60.0	107.3		
		63.7	60.0	109.5		
		63.9	60.0	108.0		
		71.7	67.2	117.0		
		81.1	76.1	135.0		
		64.0	60.2	108.1		
		80.0	75.0	135.0		
		63.4	60.0	111.5		
		77.0	72.0	130.1		
63.8		60.2	109.5			
91.1		85.0	157.5			
1280 × 1024i	50.0	86.0	80.0	RGB		
	50.0	94.0	80.0			
	46.4	86.7	78.4			
MAC	1280 × 960	75.0	75.1	126.0	RGB	
	1280 × 1024	80.0	75.1	135.2		
SXGA+	1400 × 1050	64.0	60.2	108.0	HDMI/RGB	
		65.4	60.1	122.9		
		65.1	59.9	122.4		
WXGA+	1440 × 900	55.9	59.9	106.5	RGB	
		74.9	60.0	161.9		
UXGA	1600 × 1200	75.0	60.0	162.0	HDMI/RGB	
		81.3	65.0	175.5		
		87.5	70.0	189.0		
		93.8	75.0	202.5		
WSXGA+	1680 × 1050	65.3	60.0	146.3	HDMI/RGB	
WUXGA	1920 × 1200	74.0	59.9	154.0	RGB	
		74.6	59.9	193.3		

*1 The "i" appearing after the resolution indicates an interlaced signal.

Serial connector

The serial connector complies with RS-232C. To control the projector from a personal computer, commands must be input through communication software, based on the format and satisfying the communication conditions shown below.

Pin assignments and signal names

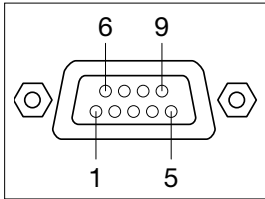

D-sub 9-pin (female)
Serial input

No.	Signal name	Description	No.	Signal name	Description
1	-	NC	6	-	NC
2	TXD	Send data	7	RTS	Connected internally
3	RXD	Receive data	8	CTS	Connected internally
4	-	NC	9	-	NC
5	GND	Ground			

Communication conditions (factory setting)

Signal level	RS-232C-compliant
Synchronization method	Start-stop synchronization
Baud rate	19,200 bps
Parity	None

Character length	8 bits
Stop bit	1 bit
X parameter	None
S parameter	None

Basic format

Transmission from the computer begins with STX, then command, parameter, and ETX are sent in this order. Add parameters according to the details of control.

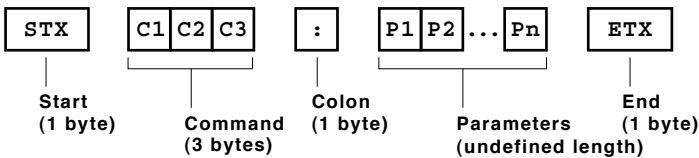

NOTE: When sending commands without parameters, a colon (:) is not necessary.

Basic format with sub-commands

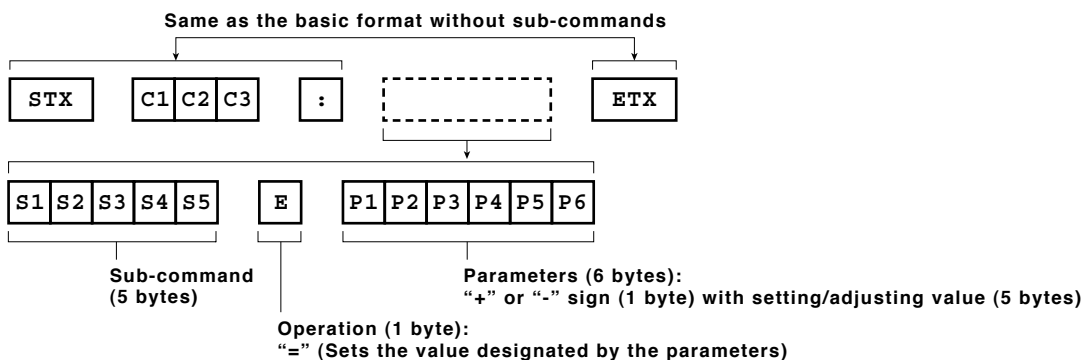

NOTE: When sending sub-commands that require no parameters, operation (E) and parameters are not necessary.

CAUTION

- It may not be possible to send or receive commands for about 10 to 60 seconds when the lamp is first turned on. If this occurs, wait for 60 seconds, then try sending or receiving again.
- When sending multiple commands, be sure to wait for at least 0.5 second after receiving a response from the projector before sending the next command.
- Additional time is sometimes required for response due to processing inside the projector. Set the time-out period for command response to 10 seconds or more.

Cable specifications

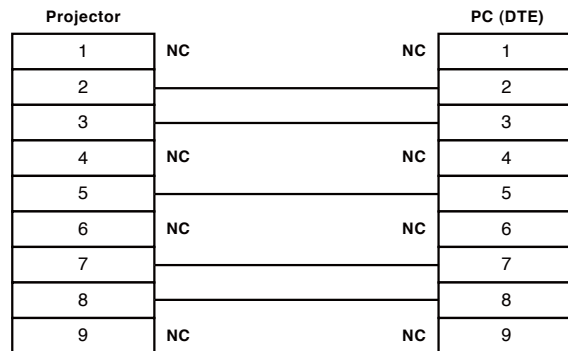

Control commands

Command: <Parameter>	Function	Callback: <Parameter>	Parameter value	
			Min	Max
PON*1/*2	Power on (standby mode on)	PON	-	-
POF*1	Power off (standby mode off)	POF	-	-
AVL:<p1>	Volume control	AVL:<p1>	0	63
IIS:<input signal>	Input signal selection	IIS:<input signal>	-	-
OFZ:<off on>	Freeze	OFZ:<off on>	0	1
VPM:STD	Picture mode: Standard	VPM:STD	-	-
VPM:DYN	Picture mode: Dynamic	VPM:DYN	-	-
VPM:CIN	Picture mode: Cinema	VPM:CIN	-	-
VPM:REA	Picture mode: Real	VPM:REA	-	-
VPM:BBD	Picture mode: Blackboard	VPM:BBD	-	-
VPM: CBD	Picture mode: Colorboard	VPM: CBD	-	-
VPM:IM1	Picture mode: Image 1	VPM:IM1	-	-
VPM:IM2	Picture mode: Image 2	VPM:IM2	-	-
VPM:IM3	Picture mode: Image 3	VPM:IM3	-	-
VPM:IM4	Picture mode: Image 4	VPM:IM4	-	-
AUU	Volume up	AUU	-	-
AUD	Volume down	AUD	-	-
OSH*1	AV mute	OSH	-	-
DZU	Digital zoom: Enlargement	DZU	-	-
DZD	Digital zoom: Reduction	DZD	-	-

*1 Do not send PON, POF, or OSH commands continuously in a short period of time. Doing so may burst the lamp or shorten the lamp replacement cycle.

*2 These commands are effective when the standby mode is set to eco. (Other commands are not effective.)

Status request commands

Command	Description	Callback <Parameter>
QPW	Standby power status	<power condition>
Q\$S	Lamp status	<lamp condition>
QIN	Input signal status	<input signal>
QAV	Volume adjustment value	<p1>
QPM	Picture mode status	Standard
		Dynamic
		Cinema
		Real
		Blackboard
		Colorboard
		Image 1
		Image 2
Image 3		
Image 4		
QFZ	Freeze status	<off on>
Q\$L	Lamp run time	<acctch>
QSH	AV mute function status	<off_on>

NOTE: If a wrong command is received, the projector will send an ER401 command to the computer.

Parameter format

Parameter format	Size (Byte)	Definition
<p1>	3 (1 or 2 bytes also possible when under control)	Decimal without signs: 0 to 999 (000, 001, 002...999) Decimal with signs: -99 to +99 (-99...-01, +00, +01, +02...+99) Callback from the projector is 3 Byte.
<off on>	1	0 = off, 1 = on
<input signal>	3	HD1 = HDMI, RG1 = computer 1, RG2 = computer 2, VID = video, SVD = S-Video
<power condition>	3	000 = power off (standby mode off), 001 = power on (standby mode on)
<lamp condition>	1	0 = standby, 1 = lamp on under control, 2 = lamp on, 3 = lamp off under control
<acctch>	4	Decimal without signs: 0000-9999 hours

NOTE: If a wrong command is received, the projector will send an ER401 command to the computer.

Command example

To set the volume to +30, send the command as shown below.

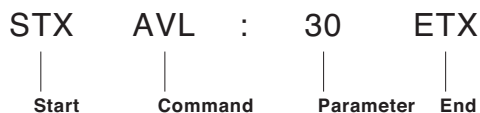

NOTE: When sending commands without parameters, a colon (:) is not necessary.

Notes on projector placement and operation

The projector uses a high-wattage lamp that becomes very hot during operation. Please observe the following precautions.

1. Never place objects on top of the projector while it is operating.
2. Make sure there is the unobstructed space as shown below or more around the projector's exhaust openings. In addition to this space, also ensure that there is a sufficient work space for removing and installing the lamp, filter and other parts.
3. Make sure that nothing blocks the projector's air intake and exhaust openings. Also, install the projector so that cool or hot air from other air conditioning equipment does not flow directly toward the projector's air intake or exhaust openings.
4. Do not install the projector in an enclosed space. If it is necessary to install it in an enclosed space, add a separate ventilation system. If ventilation is insufficient, hot air will accumulate at the intake opening. This may cause the projector's protective circuit to interrupt projector operation.

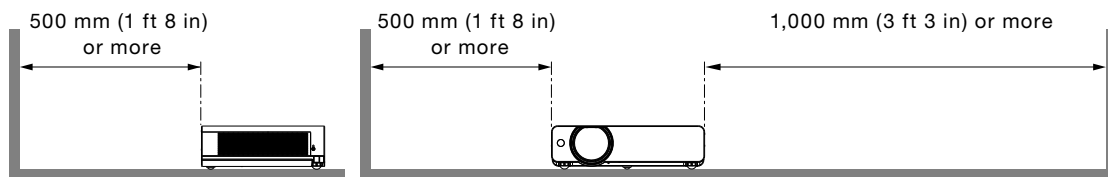

Direction of air intake and exhaust

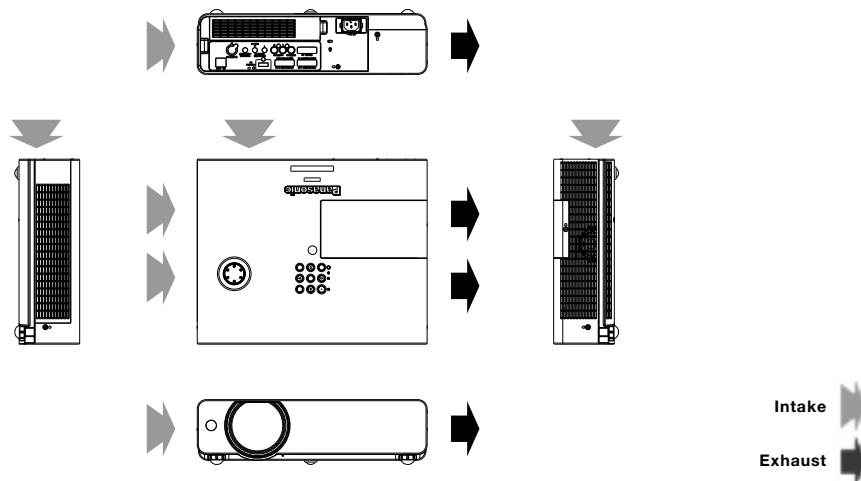

Operating the projector continuously

1. If the projector is to be operated continuously 12 hours or more, lamp replacement cycle duration becomes shorter.
2. The lamp replacement cycle duration becomes shorter if the projector is operated repeatedly for short periods (one hour or less).

Weights and dimensions shown are approximate. Specifications and appearance are subject to change without notice. Product availability differs depending on region and country. This product may be subject to export control regulations.

PJLink is a registered trademark, or a trademark application has been filed, in Japan, the United States, and other countries and regions. All other trademarks are the property of their respective trademark owners.