

Panasonic®

Operating Instructions

Functional Manual

LCD Projector Commercial Use

Model No. **PT-VW431DU**

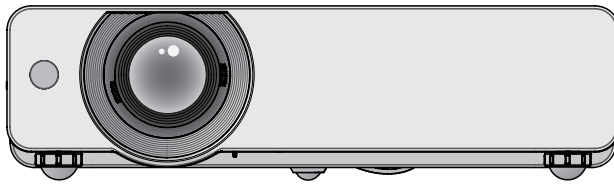

Thank you for purchasing this Panasonic Product.

- Before operating this product, please read the instructions carefully, and save this manual for future use.
- Before using your projector, be sure to read “Read this first!” (➡ pages 2 to 8).

ENGLISH

KL4AC

Read this first!

WARNING: TO REDUCE THE RISK OF FIRE OR ELECTRIC SHOCK, DONOT EXPOSE THIS PRODUCT TO RAIN OR MOISTURE.

Power Supply: This Projector is designed to operate on 100 V - 240 V, 50 Hz/60 Hz AC, house current only.

CAUTION: The AC power cord which is supplied with the projector as an accessory can only be used for power supplies up to 125 V, 10 A. If you need to use higher voltages or currents than this, you will need to obtain a separate 250 V power cord. If you use the accessory cord in such situations, fire may result.

WARNING: RISK OF ELECTRIC SHOCK, DO NOT OPEN.



The lightning flash with arrowhead symbol, within an equilateral triangle, is intended to alert the user to the presence of uninsulated "dangerous voltage" within the product's enclosure that may be of sufficient magnitude to constitute a risk of electric shock to persons.



The exclamation point within an equilateral triangle is intended to alert the user to the presence of important operating and maintenance (servicing) instructions in the literature accompanying the product.

CAUTION: This equipment is equipped with a three-pin grounding-type power plug. Do not remove the grounding pin on the power plug. This plug will only fit a grounding-type power outlet. This is a safety feature. If you are unable to insert the plug into the outlet, contact an electrician. Do not defeat the purpose of the grounding plug.

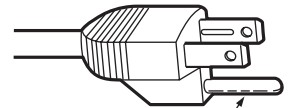

Do not remove



WARNING: TURN OFF THE UV LAMP BEFORE OPENING THE LAMP COVER.

CAUTION: To assure continued compliance, follow the attached installation instructions, which includes using the provided power cord and shielded interface cables when connecting to computer or peripheral device. If you use serial port to connect PC for external control of projector, you must use commercial RS-232C serial interface cable with ferrite core. Any unauthorized changes or modifications to this equipment will void the user's authority to operate.

FCC NOTICE (USA)**Declaration of Conformity**

Model Number: PT-VW431DU
 Trade Name: Panasonic
 Responsible Party: Panasonic Corporation of North America
 Address: One Panasonic Way, Secaucus, NJ 07094
 Telephone number: (877)803-8492
 E-mail: projectorsupport@us.panasonic.com

This device complies with Part 15 of the FCC Rules.

Operation is subject to the following two conditions:

(1) This device may not cause harmful interference, and (2) this device must accept any interference received, including interference that may cause undesired operation.

To assure continued compliance, follow the attached installation instructions and do not make any unauthorized modifications.

CAUTION:

This equipment has been tested and found to comply with the limits for a Class B digital device, pursuant to Part 15 of the FCC Rules. These limits are designed to provide reasonable protection against harmful interference in a residential installation. This equipment generates, uses and can radiate radio frequency energy and, if not installed and used in accordance with the instructions, may cause harmful interference to radio communications. However, there is no guarantee that interference will not occur in a particular installation. If this equipment does cause harmful interference to radio or television reception, which can be determined by turning the equipment off and on, the user is encouraged to try to correct the interference by one of the following measures:

- Reorient or relocate the receiving antenna.
- Increase the separation between the equipment and receiver.
- Connect the equipment into an outlet on a circuit different from that to which the receiver is connected.
- Consult the dealer or an experienced radio/TV technician for help.

The user may find the booklet "Something About Interference" available from FCC local regional offices helpful.

FCC Warning:

To assure continued FCC emission limit compliance, follow the attached installation instructions and the user must use only shielded interface cables when connecting to host computer or peripheral devices. Also, any unauthorized changes or modifications to this equipment could void the user's authority to operate this device.

NOTIFICATION (Canada)

This class B digital apparatus complies with Canadian ICES-003.

WARNING:

- Not for use in a computer room as defined in the Standard for the Protection of Electronic Computer/Data Processing Equipment, ANSI/NFPA 75.
- For permanently connected equipment, a readily accessible disconnect device shall be incorporated in the building installation wiring.
- For pluggable equipment, the socket-outlet shall be installed near the equipment and shall be easily accessible.

Notice (USA only):

- This product has a High Intensity Discharge (HID) lamp that contains mercury. Disposal may be regulated in your community due to environmental considerations. For disposal or recycling information, please visit Panasonic website: <http://www.panasonic.com/environmental> or call 1-888-769-0149.

Read this first!

WARNING:

■ POWER

The wall outlet or the circuit breaker shall be installed near the equipment and shall be easily accessible when problems occur. If the following problems occur, cut off the power supply immediately.

Continued use of the projector in these conditions will result in fire or electric shock.

- If foreign objects or water get inside the projector, cut off the power supply.
- If the projector is dropped or the cabinet is broken, cut off the power supply.
- If you notice smoke, strange smells or noise coming from the projector, cut off the power supply.

Please contact an Authorized Service Center for repairs, and do not attempt to repair the projector yourself.

During a thunderstorm, do not touch the projector or the cable.

Electric shocks can result.

Do not do anything that might damage the power cord or the power plug.

If the power cord is used while damaged, electric shocks, short-circuits or fire will result.

- Do not damage the power cord, make any modifications to it, place it near any hot objects, bend it excessively, twist it, pull it, place heavy objects on top of it or wrap it into a bundle.

Ask an Authorized Service Center to carry out any repairs to the power cord that might be necessary.

Insert the power plug securely into the wall outlet.

If the plug is not inserted correctly, electric shocks or overheating will result.

- Do not use anything other than the provided power cord.
- Do not use the provided power cord for other electrical equipment.
- Do not use plugs which are damaged or wall outlets which are coming loose from the wall.

Clean the power plug regularly to prevent it from becoming covered in dust.

Failure to observe this will cause a fire.

- If dust builds up on the power plug, the resulting humidity can damage the insulation.
- If not using the projector for an extended period of time, pull the power plug out from the wall outlet.

Pull the power plug out from the wall outlet and wipe it with a dry cloth regularly.

Do not handle the power plug with wet hands.

Failure to observe this will result in electric shocks.

Do not overload the wall outlet.

If the power supply is overloaded (ex., by using too many adapters), overheating may occur and fire will result.

■ ON USE/INSTALLATION

Do not place liquid containers on top of the projector.

If water spills onto the projector or gets inside it, fire or electric shocks will result.

If any water gets inside the projector, contact an Authorized Service Center.

Do not place the projector on soft materials such as carpets or sponge mats.

Doing so will cause the projector to overheat, which can cause burns, fire or damage to the projector.

Do not set up the projector in humid or dusty places or in places where the projector may come into contact with oily smoke or steam, ex. a bathroom.

Using the projector under such conditions will result in fire, electric shocks or components deterioration.

Components deterioration (such as ceiling mount brackets) may cause the projector which is mounted on the ceiling to fall down.

Do not install this projector in a place which is not strong enough to take the full weight of the projector or on top of a surface which is sloped or unstable.

Failure to observe this will cause projector to fall down or tip over the projector, and severe injury or damage could result.

Do not place another projector or other heavy objects on top of the projector.

Failure to observe this will cause the projector to become unbalanced and fall, which could result in damage or injury. The projector will be damaged or deformed.

WARNING:**Installation work (such as ceiling mount bracket) should only be carried out by a qualified technician.**

If installation is not carried out and secured correctly it can cause injury or accidents, such as electric shocks.

- Do not use anything other than an authorized ceiling mount bracket.
- Be sure to use the wire provided with the projector mount base for ceiling mount as an extra safety measure to prevent the projector from falling down (Install in a different location to the ceiling mount bracket).

Do not cover the air inlet port or the air outlet port.

Doing so will cause the projector to overheat, which can cause fire or damage to the projector.

- Do not place the projector in narrow, badly ventilated places.
- Do not place the projector on cloth or papers, as these materials could be drawn into the air inlet port.

Do not place your hands or other objects close to the air outlet port.

Doing so will cause burns or damage your hands or other objects.

- Heated air comes out of the air outlet port. Do not place your hands or face, or objects which cannot withstand heat close to this port.

Do not look and place your skin into the lights emitted from the lens while the projector is being used.

Doing so can cause burns or loss of sight.

- Strong light is emitted from the projector's lens. Do not look or place your hands directly into this light.
- Be especially careful not to let young children look into the lens. In addition, turn off the power and disconnect the power plug when you are away from the projector.

Do not insert any foreign objects into the projector.

Doing so will cause fire or electric shocks.

- Do not insert any metal objects or flammable objects into the projector or drop them onto the projector.

Never attempt to remodel or disassemble the projector.

High voltages can cause fire or electric shocks.

- For any inspection, adjustment and repair work, please contact an Authorized Service Center.

Do not project an image with the lens cover attached.

Doing so can cause fire.

Do not allow metal objects, flammable objects, or liquids to enter inside of the projector. Do not allow the projector to get wet.

Doing so may cause short circuits or overheating, and result in fire, electric shock, or malfunction of the projector.

- Do not place containers of liquid or metal objects near the projector.
- If liquid enters inside of the projector, consult your dealer.
- Particular attention must be paid to children.

Use the ceiling mount bracket specified by Panasonic.

Defects in the ceiling mount bracket will result in falling accidents.

- Attach the supplied safety cable to the ceiling mount bracket to prevent the projector from falling down.

Wiring work of LAN cables for DIGITAL LINK should only be carried out by a qualified technician.

Doing so will cause poor quality image or sound on account of imperfect work.

Read this first!

WARNING:

■ ACCESSORIES

Do not use or handle the batteries improperly, and refer to the following.

Failure to observe this will cause burns, batteries to leak, overheat, explode or catch fire.

- Do not use unspecified batteries.
- Do not disassemble dry cell batteries.
- Do not heat the batteries or place them into water or fire.
- Do not allow the + and – terminals of the batteries to come into contact with metallic objects such as necklaces or hairpins.
- Do not bring or store batteries together with metallic objects.
- Store the batteries in a plastic bag and keep them away from metallic objects.
- Make sure the polarities (+ and –) are correct when inserting the batteries.
- Do not use a new battery together with an old battery or mix different types of batteries.
- Do not use batteries with the outer cover peeling away or removed.
- Remove the empty batteries from the remote control at once.
- Insulate the battery using tape or something similar before disposal.

Do not allow children to reach the batteries (AAA/R03 type).

- The battery can cause personal injury if swallowed.
- If swallowed, seek medical advice immediately.

If the battery fluid leaks, do not touch it with bare hands, and take the following measures if necessary.

- Battery fluid on your skin or clothing could result in skin inflammation or injury.
Rinse with clean water and seek medical advice immediately.
- Battery fluid coming in contact with your eyes could result in loss of sight.
In this case, do not rub your eyes. Rinse with clean water and seek medical advice immediately.

Do not disassemble the lamp unit.

If the lamp breaks, it could cause injury.

Lamp replacement

The lamp has high internal pressure. If improperly handled, an explosion and severe injury or accidents will result.

- The lamp can easily explode if struck against hard objects or dropped.
- Before replacing the lamp, be sure to disconnect the power plug from the wall outlet.
Electric shocks or explosions can result if this is not done.
- When replacing the lamp, turn the power off and allow the lamp to cool for at least 1 hour before handling it otherwise it can cause burns.

Do not allow infants or pets to touch the remote control unit.

- Keep the remote control unit out of the reach of infants and pets after using it.

Do not use the supplied power cord with devices other than this projector.

- Using the supplied power cord with devices other than this projector may cause short circuits or overheating, and result in electric shock or fire.

Remove the depleted batteries from the remote control promptly.

- Leaving them in the unit may result in fluid leakage, overheating, or explosion of the batteries.

CAUTION:**■ POWER**

When disconnecting the power cord, be sure to hold the power plug and power connector.

If the power cord itself is pulled, the lead will become damaged, and fire, short-circuits or serious electric shocks will result.

When not using the projector for an extended period of time, disconnect the power plug from the wall outlet and remove the batteries from the remote control.

Disconnect the power plug from the wall outlet before carrying out any cleaning and replacing the unit. Electric shocks can result if this is not done.

CAUTION:**■ ON USE/INSTALLATION**

Do not put your weight on this projector.

You could fall or the projector could break, and injury will result.

- Be especially careful not to let young children stand or sit on the projector.

Do not place the projector in extremely hot locations.

Doing so will cause the outer casing or internal components to deteriorate, or result in fire.

- Take particular care in locations exposed to direct sunlight or near stoves.

Always disconnect all cables before moving the projector.

Moving the projector with cables still attached can damage the cables, which will cause fire or electric shocks to occur.

Never plug headphones and earphones into VARIABLE AUDIO OUT jack.

Excessive sound pressure from earphones and headphones can cause hearing loss.

■ ACCESSORIES

Do not use the old lamp unit.

If used it could cause lamp explosion.

If the lamp has broken, ventilate the room immediately. Do not touch or bring your face close to the broken pieces.

Failure to observe this will cause the user to absorb the gas which was released when the lamp broke and which contains nearly the same amount of mercury as fluorescent lamps, and the broken pieces will cause injury.

- If you believe that you have absorbed the gas or that the gas has got into your eyes or mouth, seek medical advice immediately.
- Ask your dealer about replacing the lamp unit and check the inside of the projector.

Brazil Only Brasil Apenas

■ Manuseio de baterias usadas



BRASIL

Após o uso, as pilhas e /ou baterias poderão ser entregues ao estabelecimento comercial ou rede de assistência técnica autorizada.

Cobrir os terminais positivo (+) e negativo (-) com uma fita isolante adesiva, antes de depositar numa caixa destinada para o recolhimento. O contato entre partes metálicas pode causar vazamentos, gerar calor, romper a blindagem e produzir fogo.

Não desmonte, não remova o invólucro, nem amasse a bateria. O gás liberado pela bateria pode irritar a garganta, danificar o lacre do invólucro ou o vazamento provocar calor, ruptura da blindagem e produzir fogo devido ao curto circuito dos terminais.

Não incinere nem aqueça as baterias, elas não podem ficar expostas a temperaturas superiores a 100 °C (212 °F). O gás liberado pela bateria pode irritar a garganta, danificar o lacre do invólucro ou o vazamento provocar calor, ruptura da blindagem e produzir fogo devido ao curto circuito dos terminais provocado internamente.

Evite o contato com o líquido que vazar das baterias. Caso isto ocorra, lave bem a parte afetada com bastante água. Caso haja irritação, consulte um médico.

■ Remoção das baterias

1. Pressione a guia e levante a tampa.

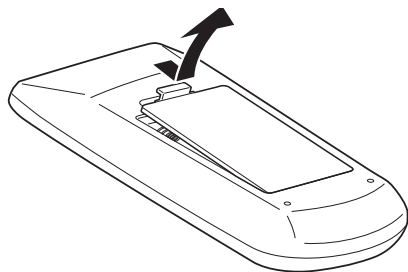

2. Remova as baterias.

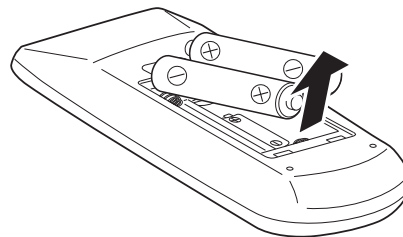

Trademarks

- Microsoft® and its logos, Windows®, Windows® XP, Windows Vista®, Windows 7®, and Internet Explorer® are the registered trademarks or trademarks of Microsoft Corporation in the United States and/or other countries.
- Macintosh, Mac OS and Safari are the trademarks of Apple Inc. registered in the United States and other countries.
- HDMI, the HDMI logo and High-Definition Multimedia Interface is a trademark or registered trademark of HDMI Licensing LLC.



- PJLink™ is a trademark or pending trademark in Japan, the United States, and other countries and regions.
- RoomView, Crestron RoomView are registered trademarks of Crestron Electronics, Inc, and Crestron Connected and Fusion RV are the trademarks of Crestron Electronics, Inc.
- Other names, company names or product names used in these operating instructions are the trademarks or registered trademarks of their respective holders.

Please note that the operating instructions do not include the ® and ™ symbols.

Illustrations in these operating instructions

- Note that illustrations of the projector and screens may differ from the ones you actually see.

Page references

- In these instructions, references to pages are indicated as: (➡ page 00).

Term

- In these instructions, the “Wireless remote control unit” accessory is referred to as the “Remote control”.

Features of the Projector

Auto Setup Function

- ▶ This function executes Input search, Auto PC adjustment and Auto Keystone correction at the same time by pressing the <AUTO SETUP> button on the remote control.

Direct Power Off Function

- ▶ With the Direct Power Off function, you can disconnect the power cord from the wall outlet or turn off the breaker even during projection.

Improved connectivity

- ▶ This function supports technology that can transmit a video and audio signal except Ethernet signal through a twisted pair cable, and without complex cable connections.

Useful Functions for Presentations

- ▶ The digital zoom function allows you to focus on the crucial information during a presentation.
- ▶ The MIC function and 10 W audio output allows you to make a presentation without any external audio equipment.

Quick steps

For details, see the corresponding pages.

1. **Set up your projector.**
(⇒ page 22)



2. **Connect with other devices.**
(⇒ page 26)



3. **Connect the power cord.**
(⇒ page 27)



4. **Power on.**
(⇒ page 29)



5. **Select the input signal.**
(⇒ page 32)



6. **Adjust the image.**
(⇒ page 32)

Contents

Be sure to read "Read this first!". (➔ pages 2 to 8)

Important Information

Read this first!	2
Contents	10
Precautions for Use	12
Cautions when transporting.....	12
Cautions when installing.....	12
Security	13
Disposal.....	14
Cautions on use	14
Accessories	15
Optional accessories	16

Preparation

About Your Projector	17
Remote control	17
Projector body	18
Control panel and Indicators	19
Rear terminals	20
Using Remote control	21
Installing and Removing batteries	21
Setting Remote control ID numbers	21

Getting Started

Setting up	22
Projection method	22
Parts for ceiling mount (Optional).....	22
Screen size and throw distance	23
Adjusting front adjustable feet	25
Adjusting the position by using the vertical lens shift function	25
Connections	26
Before connecting to the projector	26
Connecting example.....	26

Basic Operation

Powering ON/OFF	27
Connecting the power cord	27
ON(G)/STANDBY(R) indicator.....	28
Turning On the Projector	29
Enter a PIN code	30
Turning Off the Projector	31
Projecting	32
Selecting the input signal	32
How to adjust the state of the image	32
Basic operations by using the remote control	33
Using the AUTO SETUP function	33

Switching the input signal	33
Using the SCREEN button	33
Using the KEYSTONE button.....	34
Using the INFO. button.....	34
Using the FREEZE function	34
Using the AV MUTE function	35
Using the P-TIMER button	35
Using the LAMP button	35
Using the D.ZOOM buttons	35
Controlling the volume of the speaker.....	35
Using the IMAGE button.....	36
Using the MUTE button	36

Settings

Menu Navigation	37
Navigating through the menu	37
Main menu.....	38
Sub menu	38
Input menu	40
Computer 1: RGB/Component /RGB (Scart)	40
Computer 2: RGB.....	40
HDMI	40
Video	40
S-video	40
DIGITAL LINK.....	40
System	40
AUTO PC adjust	42
Auto PC adj.	42
Manual PC adjust	43
Fine sync	43
Total dots	43
Horizontal	43
Vertical.....	43
Current mode	44
Clamp	44
Display area H.....	44
Display area V	44
Reset	44
Mode free	44
Store	44
Image select	45
Dynamic	45
Standard.....	45
Real	45
Cinema	45
Blackboard(Green).....	45
Colorboard.....	45
Image 1-4	45
Image adjust	46
Contrast.....	46
Brightness	46
Color	46

Tint	46	Video delay control	59
Iris	46	Filter counter	59
Color temp.	47	Emulate	59
Red	47	RS232C	60
Green	47	Warning log	60
Blue	47	Factory default.....	60
Daylight View	47	Information.....	61
Sharpness	48	Input Source Information Display	61
Gamma.....	48	Network	62
Noise reduction	48	DIGITAL LINK mode	62
Progressive	48	DIGITAL LINK setup	62
Reset	48	DIGITAL LINK status	62
Store.....	48	Projector name	63
Screen	49	Network setup	63
Normal	49	Network control	64
Full	49	Network status.....	64
Wide(16:9).....	49	AMX D.D.	64
Zoom	49	RoomView	64
True	49	Extron XTP	64
Natural wide	49	Digital Interface Box	64
Custom	49	Network factory default.....	64
Custom adj.	50	Network connections	65
Digital zoom +.....	50	Twisted pair cable Extender connections	66
Digital zoom -.....	50	Computer operation.....	67
Keystone	50	Accessing from the Web browser.....	67
Ceiling	51		
Rear.....	51		
Screen aspect	51		
Reset	51		
Sound	52		
Volume	52		
Mute	52		
MIC	52		
MIC gain	52		
In standby mode.....	52		
Setting	53		
Language	53		
Menu position	53		
Auto setup	53		
Background	54		
Display.....	54		
Logo	54		
HDMI setup	55		
DIGITAL LINK signal level	55		
Terminal.....	55		
Power management	55		
Direct on	56		
Standby mode	56		
P-timer	56		
Closed caption.....	57		
Lamp power.....	57		
Remote control	57		
Security	57		
Fan	58		
Fan control	58		

Maintenance

LAMP and WARNING Indicators	79
Managing the indicated problems	79
Replacement	80
Before replacing the unit	80
Maintenance	80
Replacing the unit.....	80
Attaching the Lens Cap	84
Troubleshooting	85

Appendix

Technical Information	87
PJLink protocol	87
Control commands via LAN.....	88
Serial terminal	90
Other terminals.....	93
List of compatible signals	94
Specifications	98
Dimensions.....	100
Ceiling mount bracket safeguards.....	100
Index	101

Precautions for Use

Cautions when transporting

- When transporting the projector, hold it securely by its bottom and avoid excessive vibration and impacts. Doing so may damage the internal parts and result in malfunctions.
- Do not transport the projector with the adjustable feet extended. Doing so may damage the adjustable feet.

Cautions when installing

■ Do not set up the projector outdoors.

- The projector is designed for indoor use only.

■ Do not use under the following conditions.

- Places where vibration and impacts occur such as in a car or vehicle: Doing so may damage the internal parts and result in malfunctions.
- Near the exhaust of an air conditioner or near lights (studio lamps, etc.) where temperature changes greatly (Operating environment ➔ page 99): Doing so may shorten the life of the lamp or result in deformation of the outer case and malfunctions.
- Near high-voltage power lines or near motors: Doing so may interfere with the operation of the projector.

■ Be sure to ask a specialized technician when installing the product to a ceiling.

This requires an optional ceiling mount bracket.

Model No.: ET-PKV100H (for high ceilings), ET-PKV100S (for low ceilings),
ET-PKV200B (Projector Mount Base).

■ Qualified cable is required for DIGITAL LINK connection, be sure to consult a specialized technician or your dealer.

Imperfect wiring may cause poor performance of cable transmission, such as distorted or choppy image and sound.

■ The interface box may not work properly due to strong radiowave from the broadcast station or the radio.

If there is any facility or equipment, which outputs strong radiowave, near the installation location, install the interface box at a location sufficiently far from the source of the radiowave. Or, wrap the LAN cable connected to the <DIGITAL LINK> terminal by using a piece of metal foil or a metal pipe, of which is grounded at both ends.

■ When using the projector in the elevation of below 1 200 m (3 937 ft), make sure [Fan control] is set to [Off].

Failure to do so may shorten the life of the internal parts and result in malfunctions.

■ When using the projector in the elevation of above 1 200 m (3 937 ft) and below 2 000 m (6 562 ft), make sure [Fan control] is set to [On 1].

Failure to do so may shorten the life of the internal parts and result in malfunctions.

■ When using the projector in the elevation of above 2 000 m (6 562 ft) and below 2 700 m (8 858 ft), make sure [Fan control] is set to [On 2].

Failure to do so may shorten the life of the internal parts and result in malfunctions.

■ Do not install the projector at elevations of 2 700 m (8 858 ft) or higher above sea level.

Failure to do so may shorten the life of the internal parts and result in malfunctions.

Do not tilt the projector or place it on its side.

Do not tilt the projector body more than approximately ± 30 degrees vertically or ± 15 degrees horizontally. Over tilting may result in shortening the life of the components.

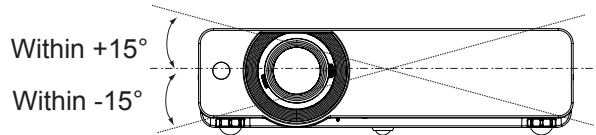
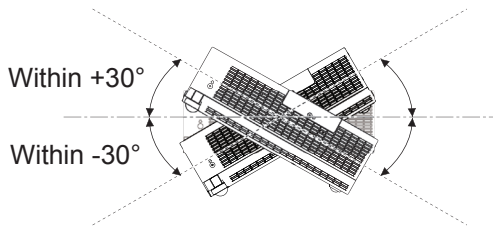

Cautions when setting the projectors

- Do not stack the projectors.
- Do not block the ventilation ports (intake and exhaust) of the projector.
- Avoid heating and cooling air from the air conditioning system directly blow to the ventilation ports (intake and exhaust) of the projector.

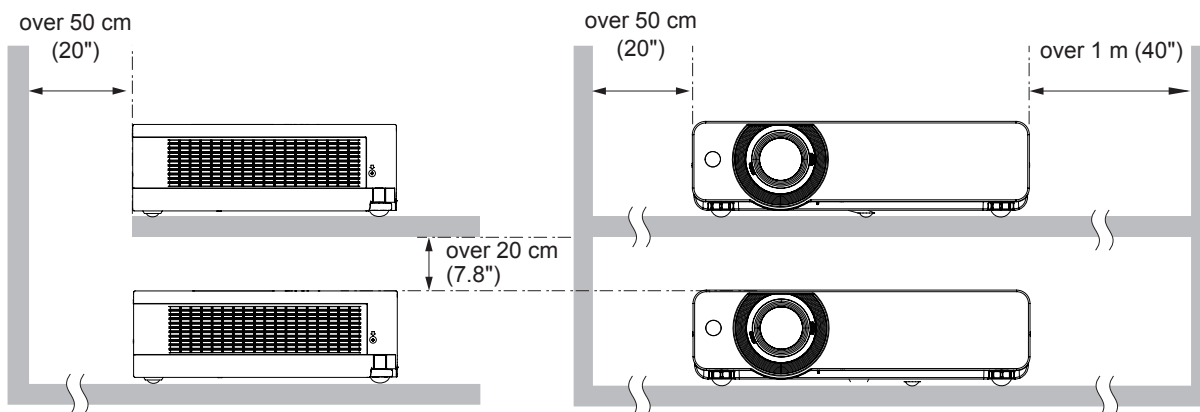
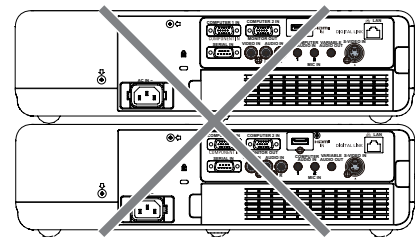

- Do not place the projector in an enclosed space.
If you need to place the projector in an enclosed space, additional air conditioning and ventilation system must be equipped. When ventilation is insufficient, remaining heat may trigger the protection circuit of the projector.

Security

Take safety measures against following incidents.

- Personal information being leaked via this product.
- Unauthorized operation of this product by a malicious third party.
- Interfering or stopping of this product by a malicious third party.

Security instruction (➔ page 57, 76)

- Make your password as difficult to guess as possible.
- Change your password periodically.
- Panasonic or its affiliate company never inquires a password directly to a customer. Do not tell your password in case you receive such an inquiry.
- The connecting network must be secured by firewall or others.
- Set a password for web control and restrict the users who can log in.

Precautions for Use

Disposal

When disposing of the product, ask your local authority or dealer about the correct methods of disposal. The lamp contains mercury. When disposing of the used lamp unit, ask your nearest local authorities or dealer about proper disposal of the unit. Dispose of used batteries according to the instructions or your local disposal rule or guidelines.

Cautions on use

■ In order to get the picture quality

- Draw curtains or blinds over windows and turn off any lights near the screen to prevent outside light or light from indoor lamps from shining onto the screen.
- Depending on where the projector is used, heated air from an exhaust port or warm or cold air from an air conditioner can cause a shimmering effect on screen. Avoid use in locations where exhaust or streams of air from projector, other devices and air conditioners flow between the projector and the screen.
- The lens of projector is affected by the heat from the luminous source. Because of this, the focusing may not be stable right after the power is turned on. Focusing is stabilized after projecting image for 30 minutes and longer.

■ Do not touch the surface of the projector lens with your bare hand

If the surface of the lens becomes dirty from fingerprints or anything else, this will be magnified and projected onto the screen.

■ LCD Panel

The display unit of this projector comprises three LCD panels. Although an LCD panel is a product of high-precision technology, some of the pixels on the projected image may be missing or constantly lit. Please note that this is not a malfunction.

Displaying a still image for a longer time may result in an after-image on the LCD panels. If this happens, display the all white screen in the test pattern for an hour or more.

■ Optical components

Operating the projector in an environment with high temperature or heavy exposure to dust or tobacco smoke will reduce the service life of the optical components, such as the LCD panel and polarizing plate, and may necessitate their replacement within less than one year of use. For details, consult your dealer.

■ Lamp

The luminous source of the projector is a mercury lamp with high internal pressure. A high pressure mercury lamp has following characteristics.

- The brightness of the lamp will decrease by duration of usage.
- The lamp may burst with sound or shorten life by shock or chipping.
- The life of the lamp varies greatly depending on individual specificities and usage conditions. In particular, continuous use over 12 hours and frequent on/off switching of the power greatly deteriorate the lamp and affect the lamp life.
- In rare cases, the lamp burst shortly after the projection.
- The risk of bursting increases when the lamp is used beyond its replacement cycle. Make sure to replace the lamp unit consistently. ("When to replace the lamp unit" (➡page 82))
- If the lamp bursts, gas contained inside of the lamp is released in a form of smoke.
- It is recommended to store replacement lamps for contingency.
- It is recommended to have authorized engineer or your dealer replace the lamp unit.



■ Avoidance of damage to connection terminal resulting from static electricity

Please pay attention to the following points when connecting the signal cable. Failure to do so may cause a failure in the product.

- When connecting the cable to the projector or to the external devices connected to the projector, touch a metallic object in your vicinity to discharge any static electricity from your body before handling the cable.

Accessories

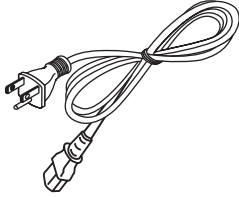
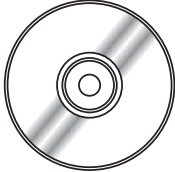
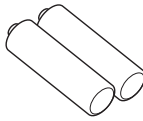
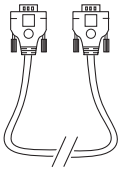
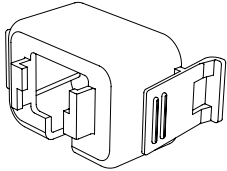
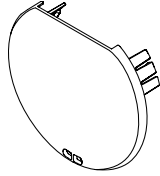
Make sure the following accessories are provided with your projector. Numbers in the brackets () show the number of accessories.

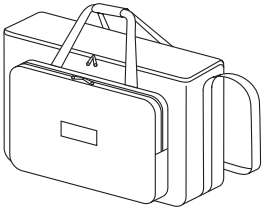
<p>Remote control unit (x1) (6451058157)</p>	<p>Power cord (x1) (6103581217)</p>	<p>CD-ROM (x1) (6103627656)</p>	<p>Batteries (AAA/R03 type) (x2)</p>
			 (for remote control unit)
<p>RGB signal cable (x1) (6103580425)</p>	<p>AC power cord holder (x1) (6451052124)</p>	<p>Lens cap (x1) (6103594279)</p>	<p>String (x1) (6103504711)</p>
		 (Attached to the projector at the time of purchase.)	
<p>Soft Carrying Case (x1) (6103601861)</p>			
			

Attention

- After unpacking the projector, discard the power cord cap and packaging material properly.
- For lost accessories, consult your dealer.
- The part numbers of accessories and separately sold components are subject to change without notice.
- Store small parts in an appropriate manner, and keep them away from young children.

Precautions for Use

■ Contents of the supplied CD-ROM

The contents of the supplied CD-ROM are as follow.

Manual/list (PDF)	Software
<ul style="list-style-type: none">● Operating Instructions – Functional Manual● Operation Manual Multi Projector Monitoring & Control Software 2.7● Operation Manual Logo Transfer Software 2.0● List of compatible projector models<ul style="list-style-type: none">• This is a list of projectors that are compatible with the software (refer to the right column), and their restrictions.	<ul style="list-style-type: none">● Multi Projector Monitoring & Control Software 2.7 (Windows)<ul style="list-style-type: none">• This software allows you to monitor and control multiple projectors connected to the LAN.● Logo Transfer Software 2.0 (Windows)<ul style="list-style-type: none">• This software allows you to create original images, such as company logos to be displayed when projection starts, and transfer them to the projector.

Optional accessories

Options	Model No.
Ceiling Mount Bracket	ET-PKV100H (for high ceilings), ET-PKV100S (for low ceilings)
Projector Mount Base	ET-PKV200B
Replacement Lamp Unit	ET-LAV200
Replacement Filter Unit	ET-RFV200
Digital Interface Box	ET-YFB100G

About Your Projector

Remote control

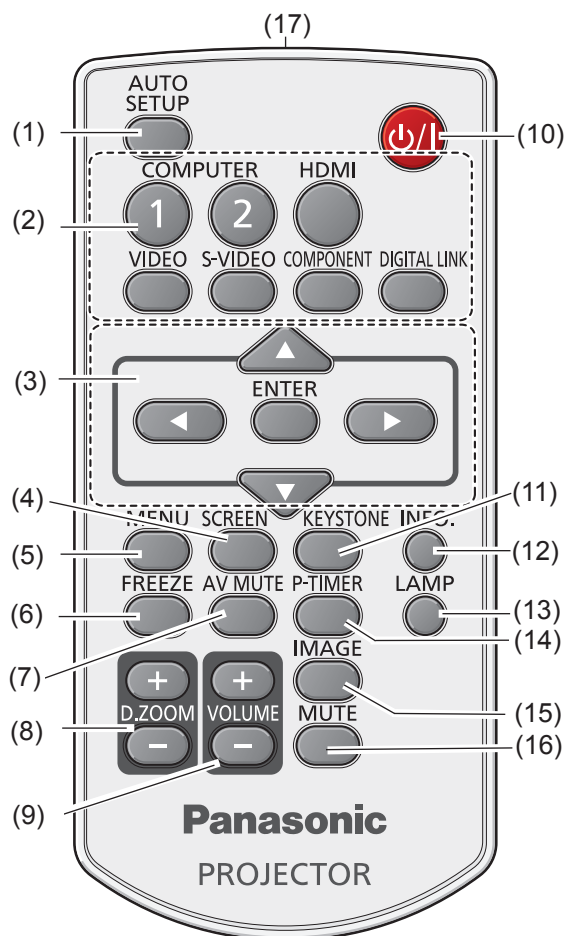

- (1) **<AUTO SETUP> Button**
Execute the setting of Auto setup in the setting menu. (➔page 53)
- (2) **Input Selection Buttons: <COMPUTER 1>, <COMPUTER 2>, <HDMI>, <VIDEO>, <S-VIDEO>, <COMPONENT>, <DIGITAL LINK>.**
These buttons are used to select the input signal. (➔page 33)
- (3) **▲▼◀▶ Buttons, <ENTER> Button**
Navigate the MENU display. (➔page 37)
- (4) **<SCREEN> Button**
Select a screen mode. (➔page 33)
- (5) **<MENU> Button**
Open or close the On-Screen Menu. (➔page 37)
- (6) **<FREEZE> Button**
Pause the projected image and sound tentatively. (➔page 34)
- (7) **<AV MUTE> Button**
Temporarily turn off the image on the screen. (➔page 35)

- (8) **<D.ZOOM +/-> Buttons**
Zoom in and out the images. (➔page 35)
- (9) **<VOLUME +/-> Buttons**
Adjust the volume of the speaker. (➔page 35)
- (10) **<⏻/⏻> Button**
Turn the projector on or off. (➔page 29)
- (11) **<KEystone> Button**
Correct keystone distortion. (➔page 34)
- (12) **<INFO.> Button**
Operate the information function. (➔page 34)
- (13) **<LAMP> Button**
Select a lamp mode. (➔page 35)
- (14) **<P-TIMER> Button**
Operate the P-timer function. (➔page 35)
- (15) **<IMAGE> Button**
Select the image mode. (➔page 36)
- (16) **<MUTE> Button**
Mute the sound. (➔page 36)
- (17) **Remote control signal emitter**

Attention

- Do not drop the remote control.
- Avoid contact with liquids.
- Do not attempt to modify or disassemble the remote control.

Note

- The remote control can be used within a distance of about 7 m (22.97 ft) if pointed directly at the remote control signal receiver. The remote control can control at angles of up to $\pm 30^\circ$ vertically and $\pm 30^\circ$ horizontally, but the effective control range may be reduced.
- If there are any obstacles between the remote control and the remote control signal receiver, the remote control may not operate correctly.
- You can operate the projector by reflecting the remote control signal on the screen. The operating range may differ due to the loss of light caused by the properties of the screen.
- When the remote control signal receiver is lit with a fluorescent light or other strong light source, the projector may become inoperative. Set the projector as far from the luminous source as possible.

About Your Projector

Projector body

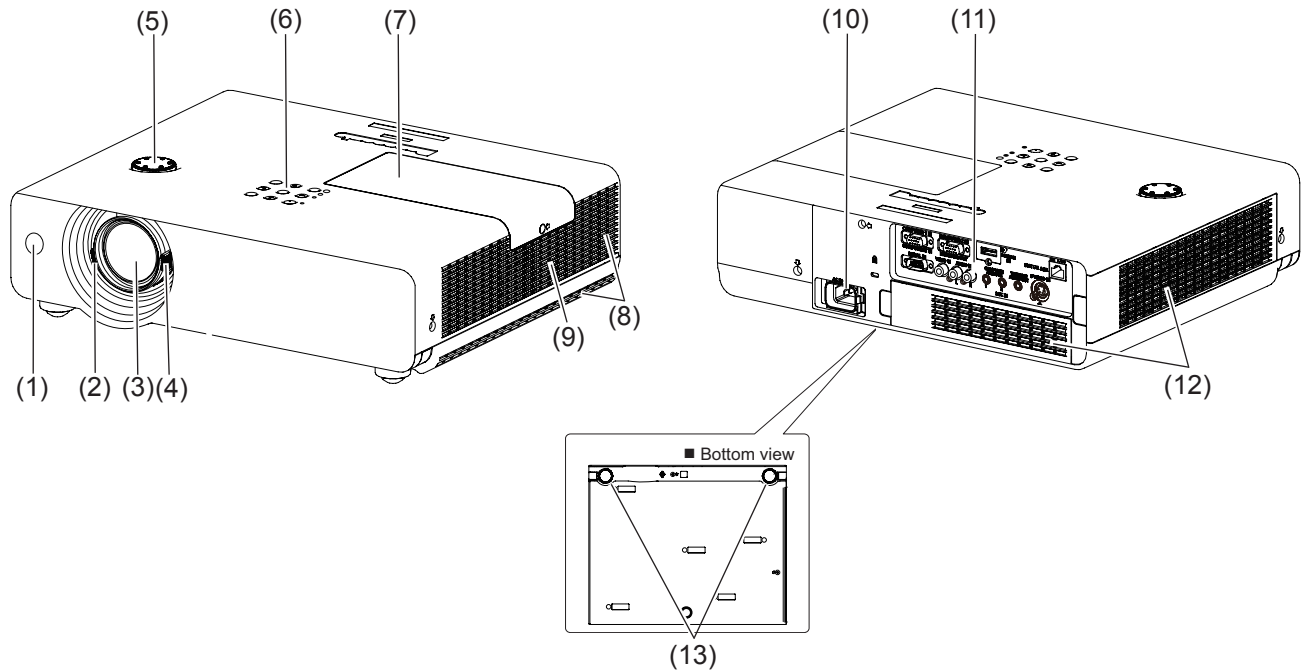

- (1) **Remote control signal receiver**
- (2) **Focus Lever** (➔page 32)
Adjust the focus.
- (3) **Projection Lens**
- (4) **Zoom Lever** (➔page 32)
Adjust the zoom.
- (5) **Vertical lens shift ring** (➔page 25)
Adjust the vertical position of the projected image.
- (6) **Control Panel and Indicators** (➔page 19)
- (7) **Lamp cover** (➔page 83)
The lamp unit is located inside.
- (8) **Air outlet port**
 - Hot air is exhausted from the exhaust vent. Do not put heat-sensitive objects near this side.
- (9) **Speaker**
- (10) **AC IN**
- (11) **Rear terminals** (➔page 20)
- (12) **Air intake port / Air filter cover** (➔page 80)
- (13) **Adjustable feet**
Adjust the projection angle.

WARNING:

■ **Keep your hands and other objects away from the air exhaust port.**

- Keep your hand and face away.
- Do not insert your finger.
- Keep heat-sensitive articles away.

Heated air from the air exhaust port can cause burns or external damage.

Control panel and Indicators

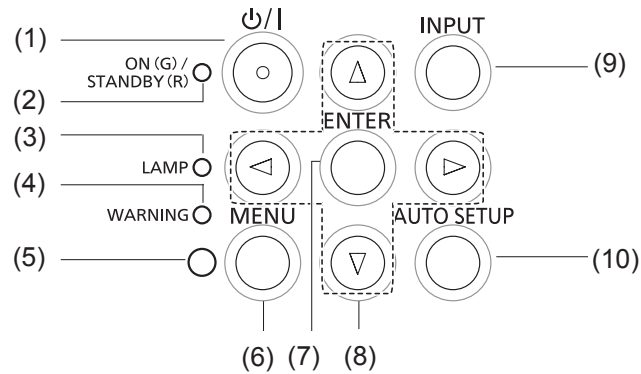

- | | |
|---|--|
| <p>(1) <P>/ > button
Turns the projector on/off.</p> <p>(2) <ON(G)/STANDBY(R)> indicator
Indicates the power status.</p> <p>(3) <LAMP> indicator
Lights yellow when the projection lamp reaches its end of life.</p> <p>(4) <WARNING> indicator
Indicates the abnormal conditions of the projector.</p> <p>(5) Ambient Luminance sensor
Detects room's light and select proper image quality.</p> | <p>(6) <MENU> button
Turns the main menu on/off. (➔page 37)</p> <p>(7) <ENTER> button
Executes the selected item.</p> <p>(8) ▲▼◀▶ buttons
Navigates the MENU screen.
Adjust the volume level or mute the sound.</p> <p>(9) <INPUT> button
Selects the input signal. (➔page 33)</p> <p>(10) <AUTO SETUP> button
Executes auto setup.</p> |
|---|--|

About Your Projector

Rear terminals

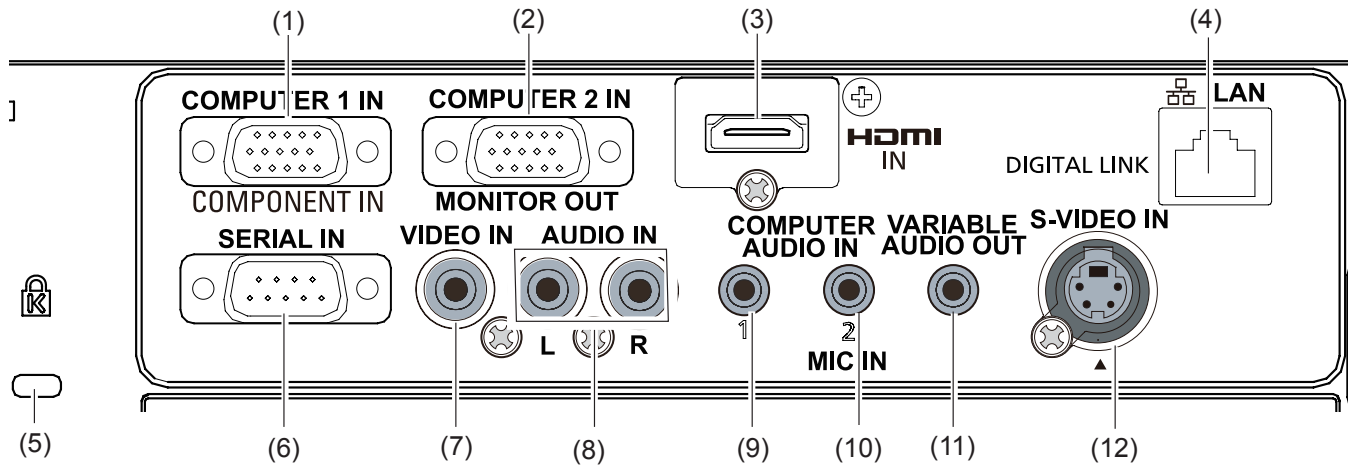

- (1) COMPUTER 1 IN / COMPONENT IN**
Connects to COMPUTER 1 IN/ COMPONENT IN input signals.
- (2) COMPUTER 2 IN / MONITOR OUT**
Connects to COMPUTER 2 IN/ MONITOR OUT input signals or outputs the analog RGB signals input the projector.
- (3) HDMI IN**
Connects to HDMI input signals.
- (4) LAN / DIGITAL LINK***
Connects to a LAN cable for network connection; or connects to a LAN cable for video and audio connection without complex cable connections.
- (5) Security slot**
Attaches the commercial shackle lock, manufactured by Kensington, to protect your projector. Compatible with the Kensington MicroSaver Security System.
- (6) SERIAL IN**
Connects to a computer via an RS-232C cable.
- (7) VIDEO IN**
Connects to VIDEO input signals.
- (8) AUDIO IN**
Connects the audio output signals from video equipment connected to (7) or (12) to this jack.
- (9) COMPUTER AUDIO IN 1**
Connects the audio output signals from a computer connected to (1) to this jack.
- (10) COMPUTER AUDIO IN 2 (MIC IN)**
Connects the audio output signals from a computer connected to (2) to this jack.
- (11) VARIABLE AUDIO OUT**
Outputs the audio signals input to the projector.
- (12) S-VIDEO IN**
Connects to S-VIDEO input signals.

Attention

- When a LAN cable is directly connected to the projector, the network connection must be made indoors.

*DIGITAL LINK is a technology to send image and sound signals via twisted pair cable.

The optional accessory Digital Interface Box (ET-YFB100G) and Extron's XTP transmitter are only matched for this projector. For twisted-pair-cable transmitter of other manufacturers of which the operation has been verified with the DIGITAL LINK compatible projector, refer to Panasonic website (<http://panasonic.net/avc/projector/>). Note that the verification for devices of other manufacturers has been made for the items set by Panasonic Corporation, and not all the operations have been verified. For operation or performance problems caused by the devices of other manufacturers, contact the respective manufacturers.

Using Remote control

Installing and Removing batteries

1) Open the cover

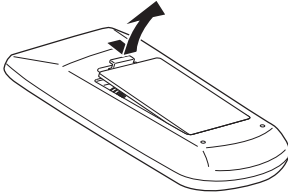

2) Install batteries and close the cover (Insert the – side first.)

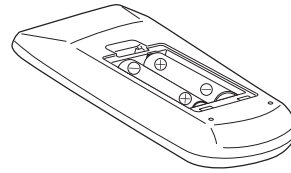

- Remove the batteries in the reverse order of installation.

Setting Remote control ID numbers

When you use the system with multiple projectors, you can operate all the projectors simultaneously or each projector individually using single remote control, if unique ID number is assigned to each projector. After setting the ID number of the projector, set the same ID number to the remote control. There are 7 different ID codes (ALL, Code 1~Code 6), the initial ID number is [ALL].

■ Setting the ID number

- 1) While holding down the <MENU> button, press the <IMAGE> button. The number of times you press the <IMAGE> button corresponds to the desired ID code number.
The number of times to press the <IMAGE> button is as follows:
Code 1= Once, Code 2= Twice, Code 3= 3 times, Code 4= 4 times
Code 5= 5 times, Code 6= 6 times.
- 2) The ID code is changed when the <MENU> button is released.

■ Resetting the ID number

The ID code is reset to [ALL] (default) by pressing the <MENU> button and <IMAGE> button at the same time for 5 seconds or more.

Attention

- If the <IMAGE> button is pressed 7 times or more, the ID code cannot be changed (the operation is invalid).

Note

- For details, please refer to the [Remote control] of the [Setting] menu.
(➔ page 57)

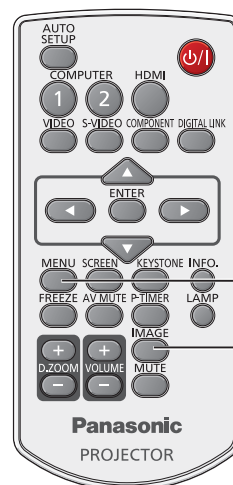

MENU button

IMAGE button

Setting up

Projection method

You can use the projector with any of the following 4 projection methods. To set the desired method in the projector.

■ Setting on a desk/floor and projecting forward

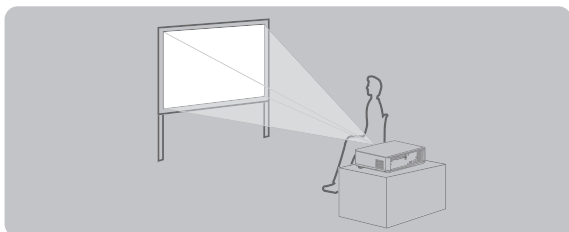

Menu setting*1

Ceiling	Off
Rear	Off

■ Mounting on the ceiling and projecting forward

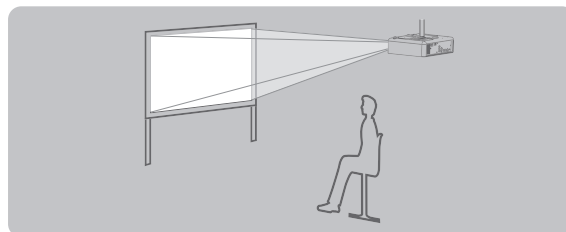

Menu setting*1

Ceiling	On
Rear	Off

■ Mounting on the ceiling and projecting from rear

(Using translucent screen)

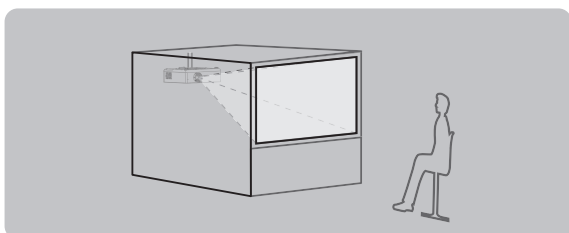

Menu setting*1

Ceiling	On
Rear	On

■ Setting on a desk/floor and projecting from rear

(Using translucent screen)

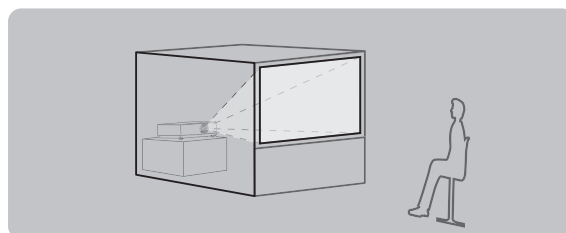

Menu setting*1

Ceiling	Off
Rear	On

*1 : For details about the menu setting, please refer to the [Screen] menu → [Ceiling] and [Rear]. (➡ page 51)

Parts for ceiling mount (Optional)

You can install the projector on the ceiling by using the optional ceiling mount bracket (ET-PKV100H: for high ceiling, ET-PKV100S: for low ceiling), and the optional projector mount base ET-PKV200B.

- Use only the ceiling mount brackets specified for this projector.
- Refer to the installation manual for the ceiling mount bracket when you install the bracket and the projector.

Attention

- To ensure projector performance and security, installation of the ceiling mount bracket must be carried by your dealer or a specialized technician.

Screen size and throw distance

Place the projector referring to the diagram on the right and the figures of throwing distance. You can adjust the display size.

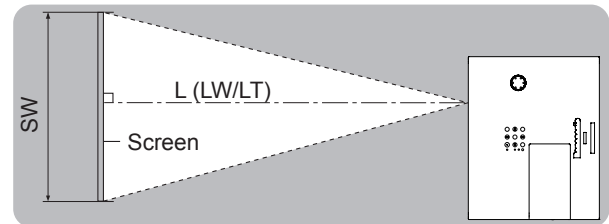
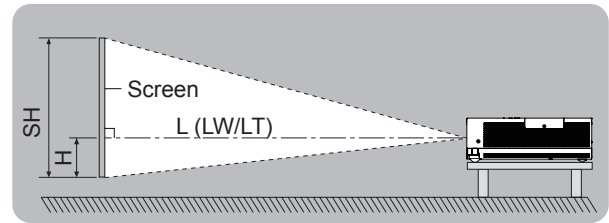
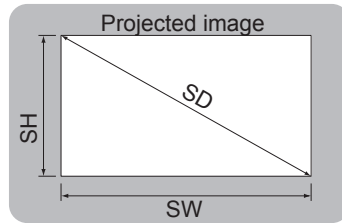

L (LW/LT) *1	Projection distance (m)
SH	Height of the projection area (m)
SW	Width of the projection area (m)
H	Distance from the center of lens to the image lower end (m)
SD	Diagonal length of the projection area (m)

*1 : LW : Minimum distance
 LT : Maximum distance

Attention

- Before installing, please read "Precautions for Use" (➡ pages 12 to 16).

■ Projection distance

All measurements below are approximate and may differ slightly from the actual measurements. (Unit: m)

Projection size	For 4:3 aspect ratio			For 16:9 aspect ratio			For 16:10 aspect ratio		
	Screen diagonal (SD)	Minimum distance (LW)	Maximum distance (LT)	Height position (H)	Minimum distance (LW)	Maximum distance (LT)	Height position (H)	Minimum distance (LW)	Maximum distance (LT)
0.76 (30")	0.8	1.4	0.009~0.229	0.8	1.3	0.007~0.187	0.7	1.2	0.008~0.202
1.02 (40")	1.1	1.8	0.012~0.305	1.0	1.7	0.010~0.249	1.0	1.6	0.011~0.269
1.27 (50")	1.4	2.3	0.015~0.381	1.3	2.1	0.012~0.311	1.3	2.0	0.013~0.337
1.52 (60")	1.7	2.8	0.018~0.457	1.6	2.5	0.015~0.374	1.5	2.5	0.016~0.404
1.78 (70")	2.0	3.3	0.021~0.533	1.8	3.0	0.017~0.436	1.8	2.9	0.019~0.471
2.03 (80")	2.3	3.7	0.024~0.610	2.1	3.4	0.020~0.498	2.0	3.3	0.022~0.538
2.29 (90")	2.6	4.2	0.027~0.686	2.3	3.8	0.022~0.560	2.3	3.7	0.024~0.606
2.54 (100")	2.9	4.7	0.030~0.762	2.6	4.2	0.025~0.623	2.5	4.1	0.027~0.673
3.05 (120")	3.5	5.6	0.037~0.914	3.1	5.1	0.030~0.747	3.1	4.9	0.032~0.808
3.81 (150")	4.3	7.0	0.046~1.143	3.9	6.4	0.037~0.934	3.8	6.2	0.040~1.010
5.08 (200")	5.8	9.4	0.061~1.524	5.3	8.5	0.050~1.245	5.1	8.3	0.054~1.346
6.35 (250")	7.3	11.7	0.076~1.905	6.6	10.6	0.062~1.557	6.4	10.3	0.067~1.683
7.62 (300")	8.7	14.0	0.091~2.286	7.9	12.7	0.075~1.868	7.7	12.4	0.081~2.019

Setting up

Any other projection distance can be obtained according to the screen dimensions (m) using the following calculations.

The calculated distance may contain a certain error.

If the screen dimensions are written as "SD",

	For 4:3 aspect ratio	For 16:9 aspect ratio	For 16:10 aspect ratio
Screen height (SH)	= SD(m) × 0.6	= SD(m) × 0.490	= SD(m) × 0.530
Screen width (SW)	= SD(m) × 0.8	= SD(m) × 0.872	= SD(m) × 0.848
Minimum distance (LW)	= 0.11461 × SD(m) - 0.02936	= 0.10402 × SD(m) - 0.02936	= 0.10122 × SD(m) - 0.02936
Maximum distance (LT)	= 0.18465 × SD(m) - 0.03190	= 0.16764 × SD(m) - 0.03190	= 0.16311 × SD(m) - 0.03190

Adjusting front adjustable feet

Lift the front of the projector and press the feet lock latches on both side of the projector. Release the feet lock latches to lock the adjustable feet and rotate the adjustable feet to a proper height and tilt. You can turn the front adjustable feet to extend them. You can turn them in the opposite direction to contract them.

(You can adjust the projection angle vertically.)

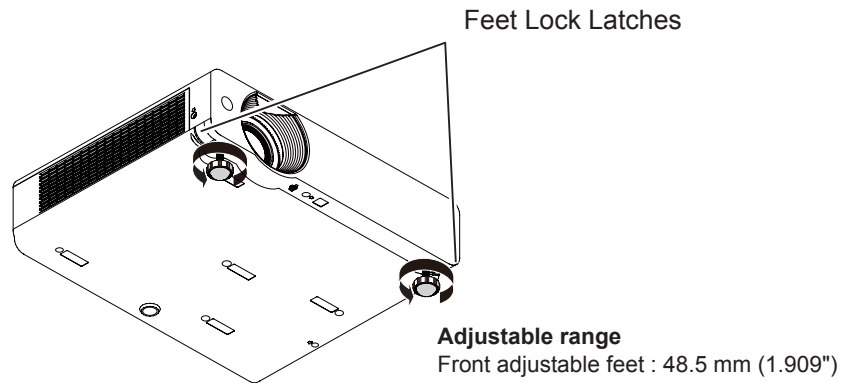

Attention

- Heated air comes out of the air exhaust port while the lamp is lit. Do not touch the air exhaust port directly when you adjust the front adjustable feet.
- If keystone distortion occurs on the projected image, perform “KEYSTONE” from the “Screen” menu. (➔page 50)

Note

- Screw up the adjustable feet, and an audible click will be heard as the limit.

Adjusting the position by using the vertical lens shift function

If the projector is not positioned right in front of the center of the screen, you can adjust the vertical position of projected image by moving the vertical lens ring within the shift range of the lens.

■ Lens shift adjustment

The display position can be shifted upward up to 48% elevation of the display. (When turn the vertical lens shift ring to the right (left), the display moves up (down)).

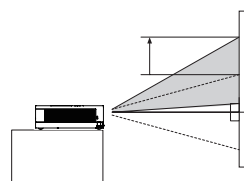

Lens shift adjustable range

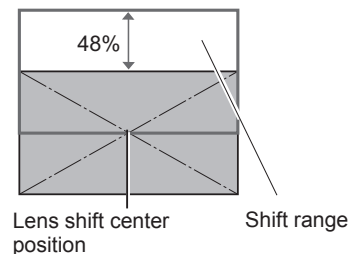

Attention

Please note the followings when using the projector.

- Do not touch the lens while it is moving as this could cause injury to the fingers.
- Never allow children to touch the lens.

Connections

Before connecting to the projector

- Read carefully the instruction manual for the device to be connected.
- Turn off the power switch of the devices before connecting cables.
- If any connection cable is not supplied with the device, or if no optional cable is available for connection of the device, prepare a necessary system connection cable to suit the device.
- Video signals containing too much jitter may cause the images on the screen to randomly wobble or wafture. In this case, a time base corrector (TBC) must be connected.
- The projector accepts the following signals: VIDEO, S-VIDEO, analogue-RGB (with TTL sync. Level) and digital signal.
- Some computer models are not compatible with the projector.
- When using long cables to connect with each of equipment to the projector, there is a possibility that the image will not be output correctly unless a compensator is used.
- For details on what video signals the projector supports, see "List of compatible signals". (▶pages 94-97)

Connecting example

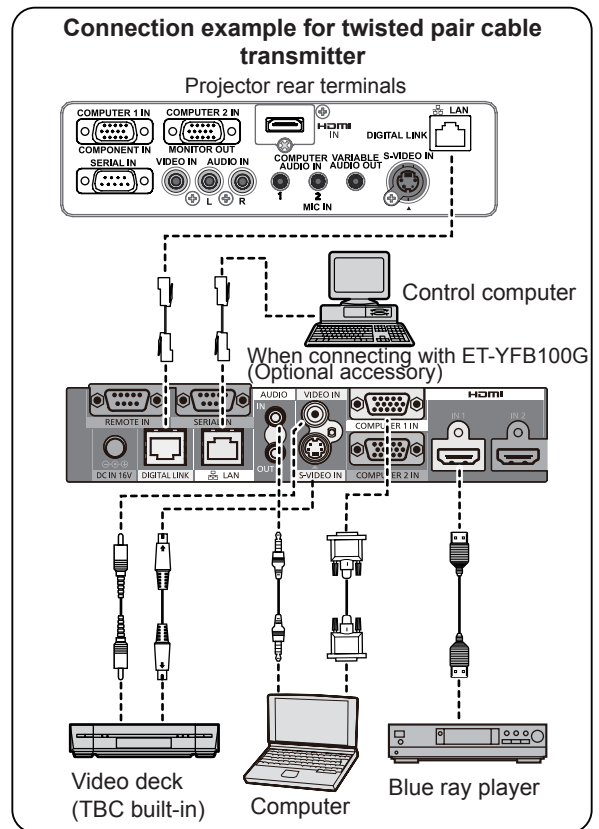
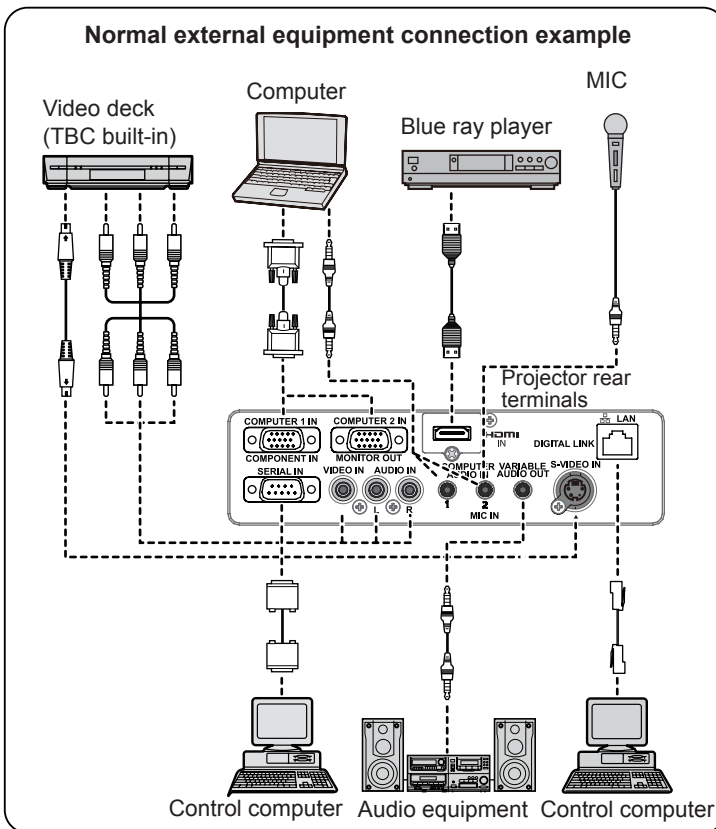

Attention

- When connecting with a video deck, be sure to use the one with a built-in time base corrector (TBC) or use a TBC between the projector and the video deck.
- If nonstandard burst signals are connected, the image may be distorted. If this is the case, connect a TBC between the projector and the video deck.

Note

- When using an HDMI cable, check that it is compliant with the HDMI standard. Using a cable that is not compliant with the HDMI standard may result in problems such as the image cutting out or not appearing. When connecting the 1080p signal using HDMI, use a cable compliant with 1080p signal.
- This projector does not support the Viera link (HDMI).
- The twisted pair cable Extender, such as Digital Interface Box (Optional accessory: ET-YFB100G) is used for sending video and audio signals via a twisted pair cable, and the <DIGITAL LINK> jack of the projector can be used for receiving these digital signals. For details on connection, please see "Twisted pair cable Extender connections". (▶page 66)

Powering ON/OFF

Connecting the power cord

Be sure to insert the attached power cord securely to its base to prevent it from coming off.

■ Power cord holder

A power cord holder is designed to prevent the AC power cord from coming off the projector. Please insert the power cord into the power cord holder correctly as Picture (1) shown:

AC Power cord holder

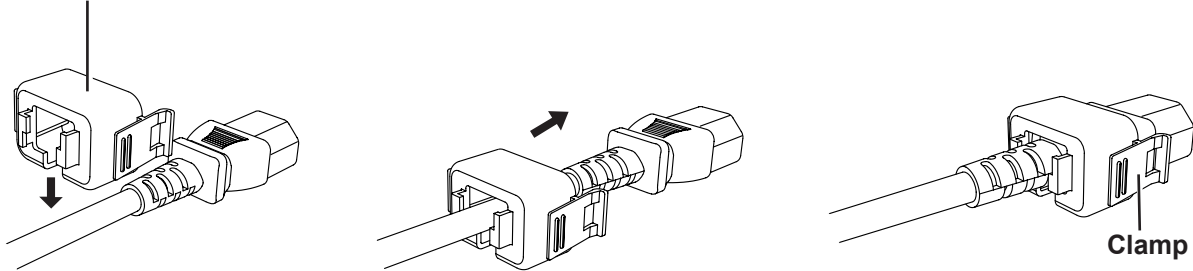

Picture (1)

■ Attaching

Attach the AC power cord with the power cord clamps to the projector as follows: Press the clamps on its sides, and then insert the AC power cord with the power cord clamps securely to the projector as Picture (2) shown. It is correctly attached until you hear the "CLICK" sound. See Picture (3) for correct attachment.

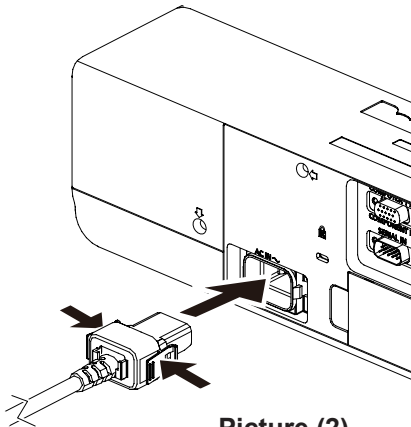

Picture (2)

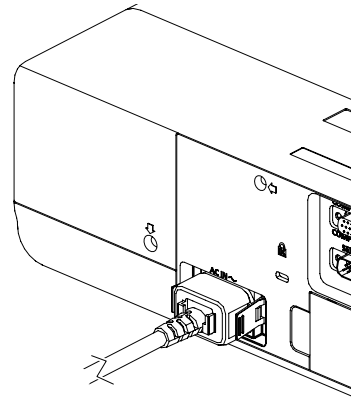

Picture (3)

■ Removal

Remove the AC power cord from the electrical outlet while pressing the clamps on its sides.

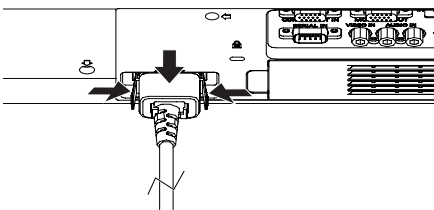

Powering ON/OFF

ON(G)/STANDBY(R) indicator

The ON(G)/STANDBY(R) indicator informs you the status of the power. Confirm the status of the <ON(G)/STANDBY(R)> indicator before operating the projector.

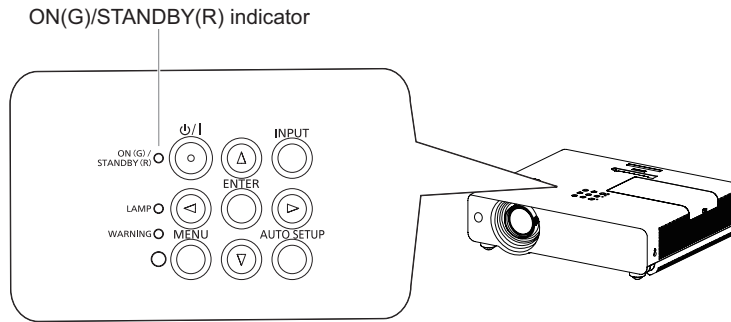

Indicator status		Status
No illumination or flashing		The power cord is unplugged.
RED	Lit	The power cord is plugged.
		The projector is in stand-by mode, after the cooling is completed.
ORANGE	Flashing	The projector is cooling down. The projector cannot be turned on until cooling is completed and the <ON(G)/STANDBY(R)> indicator stops blinking.
		The temperature inside the projector is abnormally high. And the <WARNING> indicator also blinks in red (➡ page 79). The projector cannot be turned on until cooling is completed and the <ON(G)/STANDBY(R)> indicator stops blinking.
GREEN	Lit	Projecting.
	Flashing	The projector is in stand-by status with Power management function. The projection lamp will be turned on if the input signal is reconnected or any button on the control panel or remote control is pressed. (➡ page 55)

Turning On the Projector

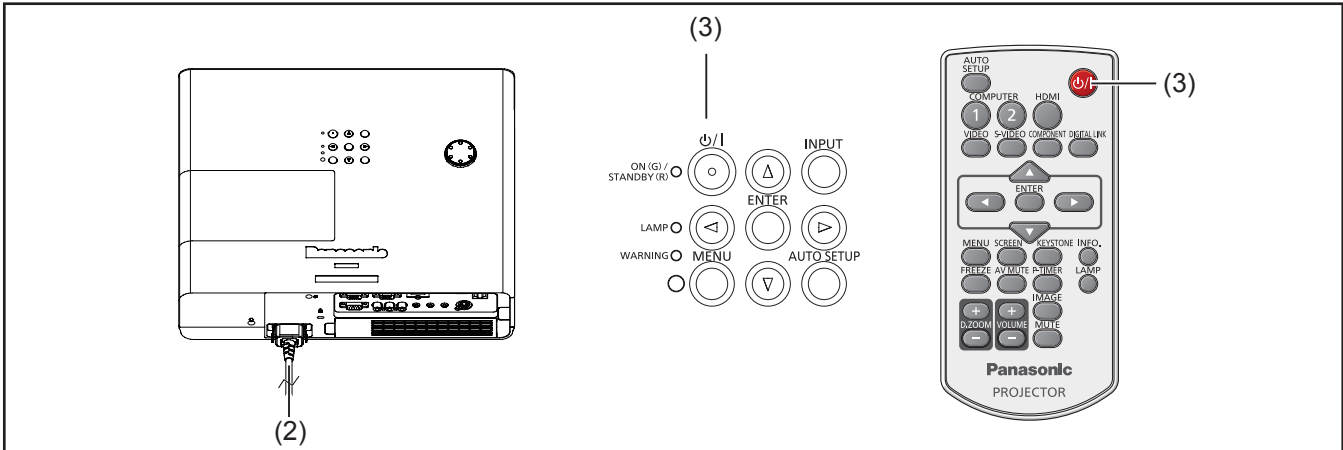

- 1) Complete peripheral connections (with a computer, VCR, etc.) before turning on the projector.
- 2) Connect the projector's AC power cord into an AC outlet. The <ON(G)/STANDBY(R)> indicator lights red. Open the lens cap.
- 3) Press the <⏻/|> button to on the control panel or on the remote control. The <ON(G)/STANDBY(R)> indicator lights green and the cooling fans start to operate. The preparation display appears on the screen and the count down starts.
- 4) After the countdown, the input source that was selected the last time and the lamp power status icon appear on the screen.
- 5) If there is no signal input when start on the projector, or the current signal is missed while operating the projector, the Video/Computer selection window will be displayed on the screen, please move the pointer to input source desired by pressing the ▲ ▼ and the <ENTER> button. And then follow the input signal guidance window to correct the signal and connection.

If the projector is locked with a PIN code, PIN code input dialog box will appear. Enter the PIN code as instructed on the next page.

Note

- When the Logo select function is set to [Off], the logo will not be shown on the screen (➡ page 54).
- When [Countdown off] or [Off] is selected in the Display function, the preparation display will not be shown on the screen (➡ page 54).
- When the Input search function is set to [On 2], the input signal will be searched automatically (➡ page 53).
- When the Direct on function is set to [On], the projector will be turned on automatically by connecting the AC power cord to an AC outlet.

Preparation display

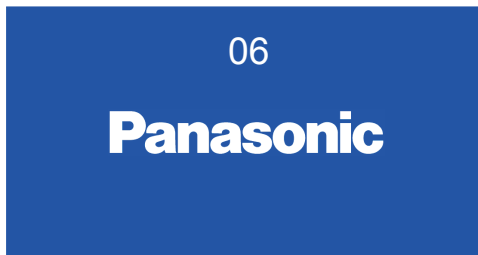

The preparation display will disappear after 30 seconds.

Selected input source and Lamp mode

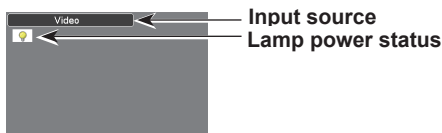

Video/Computer selection

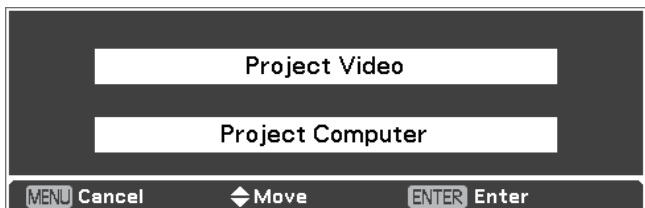

Powering ON/OFF

Enter a PIN code

Press ▲▼ to enter a number. Press ► to fix the number and move the red frame pointer to the next box. The number changes to *. If you fixed an incorrect number, use the ◀ button to move the pointer to the number you want to correct, and then enter the correct number.

Repeat this step to complete entering a four-digit number.

After entering the four-digit number, move the pointer to "Set". Press the <ENTER> button so that you can start to operate the projector.

If you entered an incorrect PIN code, PIN code and the number (****) will turn red for a moment. Enter the correct PIN code all over again.

Note

- If the PIN code number is not entered or wrong PIN code number is entered within three minutes after the PIN code dialog box appeared, the projector will be turned off automatically.
- The "1234" is set as the initial PIN code at the factory.

PIN Code Input Dialog Box

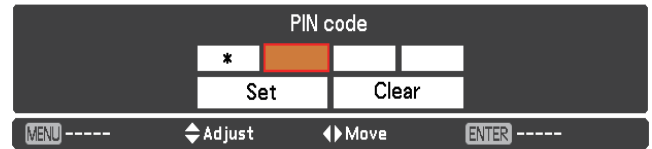

After the OK icon disappears, you can operate the projector.



Turning Off the Projector

- 1) Press the <⏻/|> button on the control panel or on the remote control, and **Power off?** appears on the screen.
- 2) Press the <⏻/|> button again to turn off the projector. The <ON(G)/STANDBY(R)> indicator starts to blink orange, and the cooling fans keep running. At this time, you can unplug the AC power cord even if the fans are still running.
- 3) When the projector has cooled down enough, the <ON(G)/STANDBY(R)> indicator stops blinking and you can turn on the projector.

Note

- Do not put the projector in a case before the projector is cooled enough.
- While the <ON(G)/STANDBY(R)> indicator is blinking, the lamp is being cooled down and the projector cannot be turned on. Wait until the <ON(G)/STANDBY(R)> indicator stops blinking to turn on the projector again.
- The projector can be turned on after the <ON(G)/STANDBY(R)> indicator turns red. The waiting time to restart will be shortened when the normal power-off processing for fan cooling is completed, compared with the time the AC power cord is immediately unplugged after the power off.

Direct Power Off function

You can disconnect the power cord from the wall outlet or turn off the breaker even during projection without pressing the <⏻/|> button.

Note

- When using the Direct power Off function, you can not restart the projector immediately after the power is disconnected. The lamp remains high temperature and needs to be cooled, so it sometimes takes longer time than usual for the lamp to light up again.

Power off ?

Power off? disappears after 4 seconds.

Projecting

Check the connections of the peripheral devices and connection of the power cord (➔ pages 26-27) and switch on the power (➔ page 29) to start the projector. Select the image and adjust the state of the image.

Selecting the input signal

Select an input signal.

The images selected using the <INPUT> button on the Control Panel or the <COMPUTER 1>, <COMPUTER 2>, <HDMI>, <VIDEO>, <S-VIDEO>, <COMPONENT>, <DIGITAL LINK> buttons on the remote control are projected (➔ page 33).

Attention

- Images may not be projected properly depending on the connected device and DVD, video tape, etc. to be played. Select a system format that is suitable for the input signal in [Component], [S-video] or [Video] under the [Input] menu (➔ page 40).
- Check the aspect ratio of the screen and the image and select the optimum aspect ratio under the [Screen] menu (➔ page 49).

How to adjust the state of the image

1) Adjust the projection angle.

- Place the projector parallel to the screen, and then install it on a flat surface so that the screen becomes rectangle.
- If the screen is tilted lower than the screen, extend the adjustable feet to make a rectangle screen.
- For details, see "Adjusting front adjustable feet" (➔ page 25).

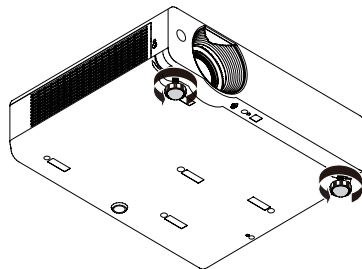

2) Adjust the lens shift.

- Adjust the projection position with the vertical lens shift ring.
- For details, see "Adjusting the position using the vertical lens shift function" (➔ page 25).

3) Adjust the zoom and the focus.

Turn [Zoom lever] and [Focus lever] to adjust the image.

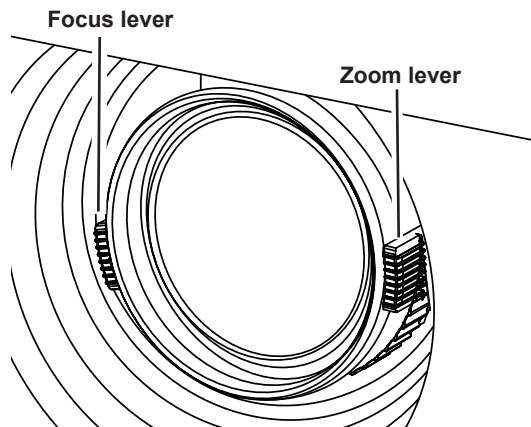

Note

- It is recommended that the images are projected continuously for at least 30 minutes before the focus is adjusted.
- If you adjust the focus, you may need to adjust the size of the image by moving the zoom lever again.
- If keystone distortion occurs, see "KEYSTONE" (➔ page 50).

Basic operations by using the remote control



COMPUTER 1	Switch to Computer 1(RGB)/ Computer 1(Scart) input.
COMPUTER 2	Switch to Computer 2(RGB)input.
HDMI	Switch to HDMI input.
VIDEO	Switch to Video input.
S-VIDEO	Switch to S-video input.
COMPONENT	Switch to Computer 1 (Component) input.
DIGITAL LINK	Switch to DIGITAL LINK input.

Note

- When connecting the optional accessory Digital Interface Box (ET-YFB100G) to the DIGITAL LINK terminal, press the <DIGITAL LINK> button on the remote control to switch the ET-YFB100G input signal.
- Each press of the <INPUT> button on the Control Panel of the main unit switches the settings as shown below. (➔page 19)

Using the AUTO SETUP function

This function allows you to automatically adjust Input search, Auto PC adjustment (during signal input from a computer) and Auto Keystone correction.



Press the <AUTO SETUP> button on the remote control.

Note

- For details, see "Setting" of Main menu. (➔page 53)

Switching the input signal

You can switch the input signals to project.

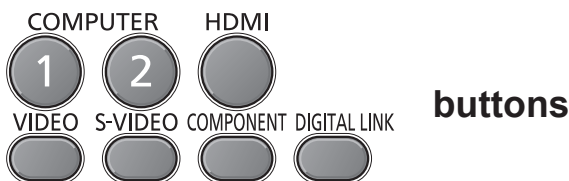

Press (<COMPUTER 1>, <COMPUTER 2>, <HDMI>, <VIDEO>, <S-VIDEO>, <COMPONENT> or <DIGITAL LINK>) button on the remote control.

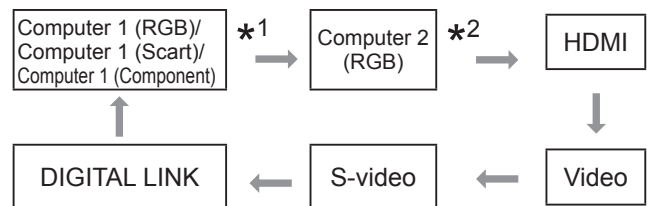

- *1: It depends on the item you selected in the [Computer 1] submenu of the [Input] menu.
- *2: When [Monitor out] is selected in the [Terminal] of the setting menu, [Computer 2(RGB)] can not be selected. Pressing <COMPUTER 2> button on the remote control displays [Monitor out].

Using the SCREEN button

This function allows you to select screen mode or change the screen size.



Press the <SCREEN> button on the remote control.

Note

- For details, see "Screen" of Main menu. (➔page 49)

Basic operations by using the remote control

Using the KEYSTONE button

This function allows you to correct keystone distortion.



Press <KEYSTONE> button on the remote control.

If a projected picture still has keystone distortion after pressing the <AUTO SETUP> button, correct the image manually as follows:

Press the <KEYSTONE> button on the remote control. The Keystone dialog box appears. Press ▲▼ to correct keystone distortion. The keystone adjustment can be stored (➡page 50).

Operation	Screen image
Reduce the upper width with press ▲.	
Reduce the lower width with press ▼.	

Note

- The white arrows indicate that there is no correction.
- A red arrow indicates the direction of correction.
- An arrow disappears at the maximum correction.
- If you press the <KEYSTONE> button on the remote control once more while the keystone dialog box is being displayed, the keystone adjustment will be canceled (➡page 50).
- The adjustable range is limited depending on the input signal.

Using the INFO. button

This function allows you to display the information menu.

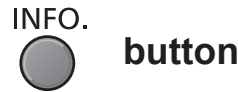

Press <INFO.> button on the remote control.

Note

- Press the <INFO.> button on the remote control to display the first page of the information menu, press again to display the second page of the menu. To close the information menu, press the <INFO.> button once again.
- For details, see “Input Source Information Display ” in “Information” under Main menu (➡page 61).

Using the FREEZE function

You can freeze the projected image and stop the sound temporarily, regardless of the playing condition of the connected device.



Press <FREEZE> button on the remote control.

Press the <FREEZE> button on the remote control to freeze the image on the screen, meanwhile, volume is muted. To cancel the Freeze function, press the <FREEZE> button again or press any other button.

Fig.1 will appear on the screen while the Freeze function is working.

Fig.1



Note

- When no signal inputs, ! mark will appear.
- During the freeze function, press <MUTE> button to unfreeze the image and resume the sound.

Basic operations by using the remote control

Using the AV MUTE function



Press <AV MUTE> button on the remote control.

Press the < AV MUTE> button on the remote control to black out the image. To restore to normal, press the < AV MUTE> button again or press any button.

- When the Logo is not set, the screen changes each time you press the < AV MUTE> button as follows.



- The projected Logo (the logo can be set according to users' favorite) is transferred from computer to the projector by "Logo Transfer Software" on the supplied CD-ROM and is set as [User] in the Logo selection (➔page 54), the screen changes each time you press the < AV MUTE> button as follows.



Note

- During the AV MUTE function, press <MUTE> button to resume the image and the sound.

Using the P-TIMER button

Press the <P-TIMER> button on the remote control to operate the Count up/Count down function.



Press <P-TIMER> button on the remote control.

Note

- To stop the count time, press the <P-TIMER> button. To cancel the P-timer function, press and hold the <P-TIMER> button. (➔page 56)

Using the LAMP button

This function allows you to select the lamp mode for changing the brightness on the screen.



Press <LAMP> button on the remote control.

Note

- For details, see "Lamp Power" of "Setting" under Main menu. (➔page 57)

Using the D.ZOOM buttons

This function allows you to enter to the Digital zoom +/- mode.



Press <D.ZOOM +/-> buttons on the remote control.

Note

- For details, see "Screen" of Main menu. (➔page 50)

Controlling the volume of the speaker

You can control the volume of the projector's speaker or audio output.



Press <VOLUME +/-> buttons on the remote control.

Press the <VOLUME +/-> buttons on the control panel or on the remote control to adjust the volume. The volume dialog box appears on the screen for a few seconds.

Note

- For details, see "Volume" of "Sound" under Main menu. (➔page 52)

Basic operations by using the remote control

Using the IMAGE button

This function allows you to select a desired image mode of the screen.

IMAGE



button

Press <IMAGE> button on the remote control.

Press <IMAGE> button on the remote control to select the desired image mode among [Dynamic], [Standard], [Real], [Cinema], [Blackboard (Green)], [Colorboard], [Image 1], [Image 2], [Image 3] and [Image 4].

Note

- For details, see “Image select” of Main menu. (➔page 45)

Using the MUTE button

Press this button on the remote control to select [On] to temporarily turn off the sound.

MUTE



button

Press <MUTE> button on the remote control.

Note

- To turn the sound back on, press this button again to select [Off] or press the <VOLUME +/-> buttons. (➔page 52)

Menu Navigation

Navigating through the menu

Operating procedure

1) Press the <MENU> button.

The Main Menu screen appears.

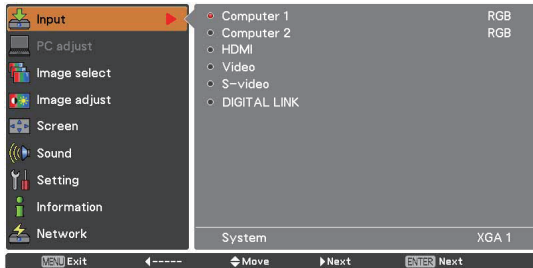

2) Press ▲▼ to select the Main Menu item.

Select the desired item from the 9 items: [Input], [PC adjust], [Image select], [Image adjust], [Screen], [Sound], [Setting], [Information] and [Network]. The selected item is highlighted with an orange cursor and the submenu of the selected item appears on the right.

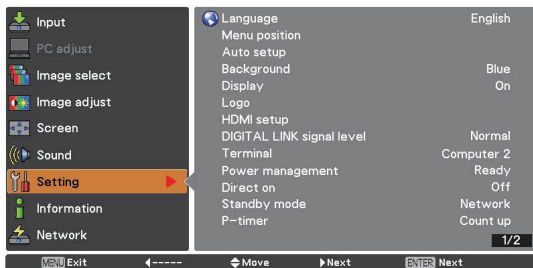

3) Press ► or the <ENTER> button.

The submenu appears so that you can select the sub-menu item.

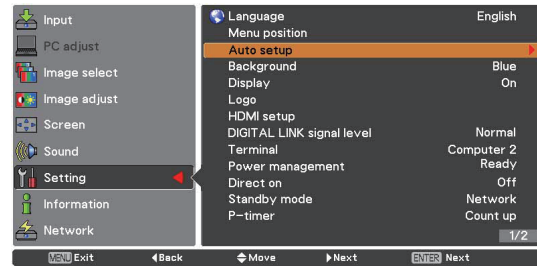

4) Press ▲▼ to select the desired sub-menu item.

5) Press the <ENTER> button or press ► to enter the desired item.

6) Press ▲▼ ◀▶ to set or adjust the parameter values.

7) Press ◀ to return the previous menu. Press the <MENU> button to exit the menu display.

Note









- Some items may not be adjusted or used for certain signal formats input to the projector. The MENU items that cannot be adjusted or used are shown in gray characters, and they cannot be selected.
- Some items can be adjusted even if signals are not input.
- See pages 38 and 39 for details on the items of submenu.

Menu Navigation

Main menu

The main menu consists of the following 9 menu items.

When a main menu item is selected, the screen changes to a submenu selection screen.

	Input
	PC adjust
	Image select
	Image adjust
	Screen
	Sound
	Setting
	Information
	Network

Sub menu

The sub-menu screen of the selected main menu appears, and you can set and adjust the various items in the submenu.

Input []

Sub-menu item	Factory default	Page
Computer 1	RGB	40
Computer 2	RGB	40
HDMI	-	40
Video	-	40
S-video	-	40
DIGITAL LINK	-	40

PC adjust []

Sub-menu item	Factory default	Page
Auto PC adj.	-	42
Fine sync.	-	43
Total dots	-	43
Horizontal	-	43

Sub-menu item	Factory default	Page
Vertical	-	43
Current mode	-	44
Clamp	-	44
Display area H	-	44
Display area V	-	44
Reset	-	44
Mode free	-	44
Store	-	44

Note

- This function will be available when the input source come from computer.

Image select []

Sub-menu item	Factory default	Page
Dynamic	-	45
Standard	-	45
Real	-	45
Cinema	-	45
Blackboard(Green)	-	45
Colorboard	Red	45
Image 1-4	-	45

Image adjust []

Sub-menu item	Factory default	Page
Contrast	32	46
Brightness	32	46
Color* ¹	32	46
Tint* ¹	32	46
Iris	-	46
Color temp.	Mid	47
Red	32	47
Green	32	47
Blue	32	47
Daylight View	-	47
Sharpness	8	48
Gamma	8	48
Noise reduction* ¹	L 1	48
Progressive* ¹	L 1	48
Reset	-	48
Store	-	48

*1 : When input video signal to the projector, these functions will be available.

Screen []

Sub-menu item	Factory default	Page
Normal	-	49
Full	-	49
Wide (16:9)	-	49
Zoom	-	49
True*1	-	49
Natural wide*2	-	49
Custom	-	49
Custom adj.	-	50
Digital zoom +*1	-	50
Digital zoom -*1	-	50
Keystone	Store	50
Ceiling	Off	51
Rear	Off	51
Screen aspect	Default(16:10)	51
Reset	-	51

*1 : When input computer signal to the projector, these functions will be available.

*2 : When input video signal to the projector, the function will be available.

Sound []

Sub-menu item	Factory Default	Page
Volume	32	52
Mute	Off	52
MIC	Off	52
MIC gain	32	52
In standby mode	Off	52

Setting []

Sub-menu item	Factory Default	Page
Language	English	53
Menu position	Center	53
Auto setup	-	53
Background	Blue	54
Display	On	54
Logo	-	54
HDMI setup	-	55
DIGITAL LINK signal level	Normal	55
Terminal	Computer 2	55
Power management	Shutdown	55
Direct on	Off	56
Standby mode	Eco	56
P-timer	Count up	56
Closed caption	Off	57
Lamp power	Normal	57

Sub-menu item	Factory Default	Page
Remote control	ALL	57
Security	-	57
Fan	L 2	58
Fan control	Off	58
Video delay control	Off	59
Filter counter	-	59
Emulate	Default	59
RS232C	Serial	60
Warning log	-	60
Factory default	-	60

Information []

Sub-menu item	Factory default	Page
Input	-	61
System	-	61
H-sync freq.	-	61
V-sync freq.	-	61
Screen	-	61
Language	-	61
Lamp power	-	61
Lamp runtime	-	61
Power management	-	61
Key lock	-	61
PIN code lock	-	61
Remote control	-	61
Serial number	-	61

Network []

Sub-menu item	Factory default	Page
DIGITAL LINK mode	Auto	62
DIGITAL LINK setup	-	62
DIGITAL LINK status	-	62
Projector name	-	63
Network setup	-	63
Network control	On	64
Network status	-	64
AMX D.D.	Off	64
Room View	Off	64
Extron XTP	Off	64
Digital Interface Box	-	64
Network factory default	-	64

Input menu

Select [Input] from the Main Menu (see “Navigating through the menu” on page 37), then select the item from the sub-menu.

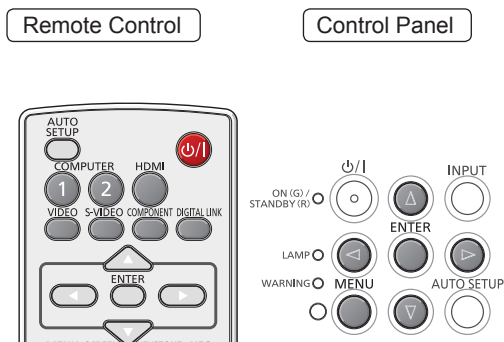

Computer 1: RGB/Component /RGB (Scart)

Projects the image of [Computer 1] input.

- 1) Press ▲ ▼ to select [Computer 1].
- 2) Press ► to access the submenu.
- 3) Press ▲ ▼ to select [RGB], [Component] or [RGB(Scart)] and then press the <ENTER> button.

Note

- When the Input Search function is set to [On 1] or [On 2] in the Auto setup function, the input signal will be searched automatically.
- The [System] cannot be selected when selecting [RGB (Scart)].

Computer 2: RGB

Projects the image of [Computer 2] input.

Press ▲ ▼ to select [Computer 2 (RGB)] and then press the <ENTER> button.

Note

- When [Monitor out] is selected in the [Terminal] of the setting menu, [Computer 2(RGB)] can not be selected. Pressing <COMPUTER 2> button on the remote control displays [Monitor out].

HDMI

Projects the image of [HDMI] input.

Press ▲ ▼ to select [HDMI] and then press the <ENTER> button.

Video

Projects the image of [Video] input.

Press ▲ ▼ to select [Video] and then press the <ENTER> button.

S-video

Projects the image of [S-video] input.

Press ▲ ▼ to select [S-video] and then press the <ENTER> button.

DIGITAL LINK

Projects the image of [DIGITAL LINK] input.

Press ▲ ▼ to select [DIGITAL LINK] and then press the <ENTER> button.

System

[System] is displayed below the sub menu.

- 1) Press ▲ ▼ to select [System] and then press ► or the <ENTER> button to access the submenu.
- 2) Press ▲ ▼ to select the desired system and then press the <ENTER> button.

■ For computer input

Auto	When there is no input signal compatible with the signal from a connected computer on the projector, the automatic PC adjustment function works and [Auto] is displayed on the system. If images are not being correctly projected, manually adjust the settings to suit your computer and register in [Store].
----	There is no input signal from the computer. Check the connections.
Mode 1- Mode 10	Displays the mode registered with [Store] in [PC adjust].

Note

- For the supported signals of the projector, see “List of compatible signals”. (► pages 94-97)

■ For video and S-video input

Auto	The projector automatically selects the color system of the input signal.
PAL/ SECAM/ NTSC/ NTSC4.43/ PAL-M/ PAL-N	When the projector can not project proper video image, please select proper color system from the menu.

■ For component input

Auto	The projector automatically selects the scanning method of the input signal.
1080i / 1035i / 720p / 576p / 480p / 576i / 480i	When video is not being played back correctly, select the correct scanning method from the menu.

AUTO PC adjust

Select [PC adjust] from the Main Menu (see “Navigating through the menu” on page 37), then select the item from the sub-menu.

Remote Control

Control Panel

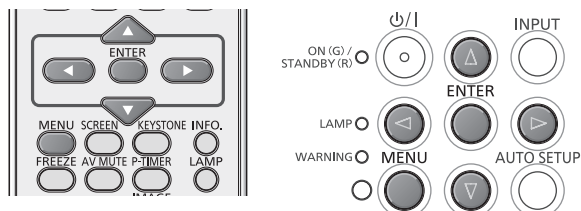

Auto PC adj.

Auto PC adjustment function is provided to automatically adjust [Fine sync], [Total dots], [Horizontal] and [Vertical] positions to conform to your computer.

Press ▲ ▼ to select [Auto PC adj.] and then press the <ENTER> button.

- Please wait... appears while the Auto PC adjustment is in process.

To store adjustment parameters

The adjusted parameters from the Auto PC adjustment can be stored in the projector. Once the parameters are stored, the setting can be done just by selecting a Mode (1–10) in the PC System Menu (see page 40). See also [Store] on page 44.

Attention

- [Fine sync], [Total dots], [Horizontal] and [Vertical] position of some computers cannot be fully adjusted with the Auto PC adjustment function. When the image is not provided properly with this operation, manual adjustments are required (► pages 43-44).
- The Auto PC adjustment cannot be operated when [480i], [576i], [480p], [576p], [720p], [1035i] or [1080i] is selected in the PC System Menu (► page 40), or when the signal is coming from the HDMI IN terminal.

Manual PC adjust

Select [PC adjust] from the Main Menu (see “Navigating through the menu” on page 37), then select the item from the sub-menu.

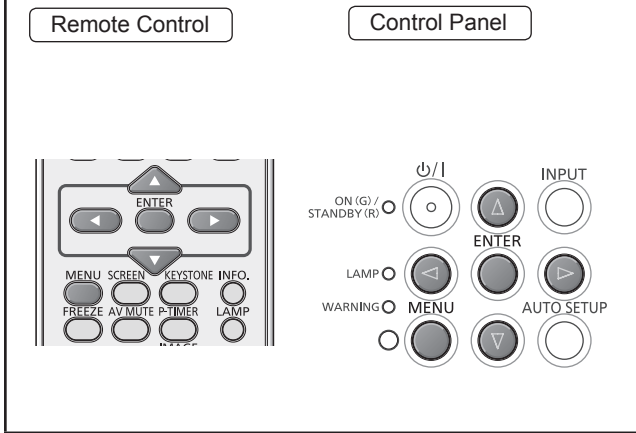

Some computers employ special signal formats which may not be tuned by Multi-scan system of this projector. Manual PC adjustment enables you to precisely adjust several parameters to match those signal formats. The projector has 10 independent memory areas to store those parameters manually adjusted. It allows you to recall the setting for a specific computer.

Fine sync

Adjusts the projector when there is flicker due to a tracking (synchronization) mismatch.

- 1) Press ▲ ▼ to select [Fine sync].
- 2) Press the <ENTER> button to display the adjustment dialog box.
- 3) Press ◀ ▶ to adjust the value.
 - The value can be adjusted from 0 to 31.

Total dots

Adjusts total number of dots in the horizontal interval.

- 1) Press ▲ ▼ to select [Total dots].
- 2) Press the <ENTER> button to display the adjustment dialog box.
- 3) Press ◀ ▶ to adjust the value.

Horizontal

- 1) Press ▲ ▼ to select [Horizontal].
- 2) Press the <ENTER> button to display the adjustment dialog box.
- 3) Press ◀ ▶ to adjust the horizontal picture position.

■ For horizontal (right and left) adjustment

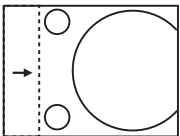
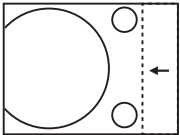
Operation	Adjustment
Press ◀.	The picture position moves to the right. 
Press ▶.	The picture position moves to the left. 

Vertical

- 1) Press ▲ ▼ to select [Vertical].
- 2) Press the <ENTER> button to display the adjustment dialog box.
- 3) Press ◀ ▶ to adjust the vertical picture position.

■ For vertical (up and down) adjustment

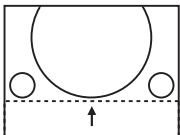
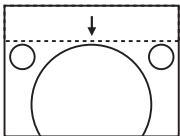
Operation	Adjustment
Press ▶.	The picture position moves up. 
Press ◀.	The picture position moves down. 

Manual PC adjust

Current mode

- 1) Press ▲ ▼ to select [Current mode].
- 2) Press ► or the <ENTER> button to enter the next submenu to show H-sync freq. and V-sync freq. of the connected computer.

Clamp

- 1) Press ▲ ▼ to select [Clamp].
- 2) Press the <ENTER> button to display the adjustment dialog box.
- 3) Press ◀ ▶ to adjust the clamp level.
 - When the image has dark bars, try this adjustment.

Display area H

- 1) Press ▲ ▼ to select [Display area H].
- 2) Press the <ENTER> button to display the adjustment dialog box.
- 3) Press ◀ ▶ to adjust the horizontal area displayed by this projector.

Display area V

- 1) Press ▲ ▼ to select [Display area V].
- 2) Press the <ENTER> button to display the dialog box.
- 3) Press ◀ ▶ to adjust the vertical area displayed by this projector.

Reset

To reset the adjusted data, all adjustments will return to their previous figures.

- 1) Press ▲ ▼ to select [Reset].
- 2) Press the <ENTER> button.
 - A confirmation box appears and then select [Yes].

Mode free

Deletes the values registered in [Store].

- 1) Press ▲ ▼ to select [Mode free].
- 2) Press ► or the <ENTER> button to enter the next submenu.
 - Move the highlight to the mode that you want to clear and then press the <ENTER> button.
 - A confirmation box appears and then select [Yes].

Store

Registers the adjusted values in [Store].

- 1) Press ▲ ▼ to select [Store].
- 2) Press ► or the <ENTER> button to enter the next submenu.
 - Move the highlight to one of the Modes 1 to 10 in which you want to store, and then press the <ENTER> button.
 - A confirmation box appears and then select [Yes].

Image select

Select [Image select] from the Main Menu (see “Navigating through the menu” on page 37), then select the item from the sub-menu.

Remote Control

Control Panel

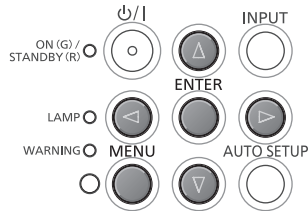
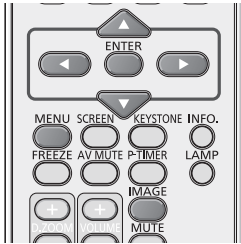

Dynamic

For viewing pictures in a bright room.

Press ▲▼ to select [Dynamic] and then press the <ENTER> button.

Standard

Normal picture mode preset on the projector.

Press ▲▼ to select [Standard] and then press the <ENTER> button.

Real

Picture mode with improved halftone for graphics.

Press ▲▼ to select [Real] and then press the <ENTER> button.

Cinema

Picture mode adjusted with fine tone.

Press ▲▼ to select [Cinema] and then press the <ENTER> button.

Blackboard(Green)

For the image projected on a blackboard.

Press ▲▼ to select [Blackboard(Green)] and then press the <ENTER> button.

- This mode helps enhance the image projected on a blackboard. This is mainly effective on a green colored board, not truly effective on a black colored board.

Colorboard

For the image projected on a colorboard.

- 1) **Press ▲▼ to select [Colorboard].**
- 2) **Press ► or the <ENTER> button to display the submenu.**
- 3) **Press ▲▼ to select a color, and press the <ENTER> button.**

- At the time of simple projection on the colored wall, you can get the close color image to the color image projected on a white screen by selecting the similar color to the wall color from the preset four colors (Red, Blue, Yellow and Green).

Image 1-4

For viewing with the user preset image mode in the Image adjust Menu.

Press ▲▼ to select [Image 1-4] and then press the <ENTER> button.

Image adjust

Select [Image adjust] from the Main Menu (see “Navigating through the menu” on page 37), then select the item from the sub-menu.

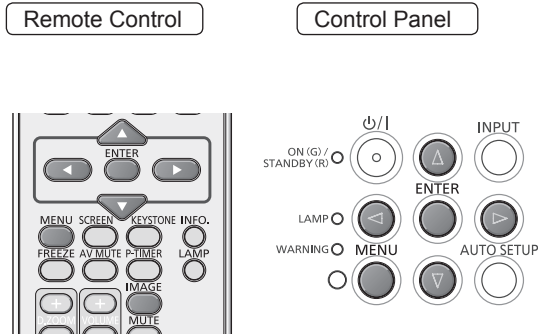

Note

- Make sure you selected [Store] after adjusting settings. Some settings can not be stored if not registered with Store function.

Contrast

- 1) Press ▲ ▼ to select [Contrast].
- 2) Press the <ENTER> button to display the adjustment dialog box.
- 3) Press ◀ ▶ to adjust the setting value.

Operation	Adjustment	Adjustment range
Press ▶.	increase the contrast	Maximum value 63
Press ◀.	decrease the contrast	Minimum value 0

Brightness

- 1) Press ▲ ▼ to select [Brightness].
- 2) Press the <ENTER> button to display the adjustment dialog box.
- 3) Press ◀ ▶ to adjust the setting value.

Operation	Adjustment	Adjustment range
Press ▶.	increase the brightness	Maximum value 63
Press ◀.	decrease the brightness	Minimum value 0

Color

- 1) Press ▲ ▼ to select [Color].
- 2) Press the <ENTER> button to display the adjustment dialog box.
- 3) Press ◀ ▶ to adjust the setting value.

Operation	Adjustment	Adjustment range
Press ▶.	increase the intensity of the color	Maximum value 63
Press ◀.	decrease the intensity of the color	Minimum value 0

Note

- When input video signal to the projector, [Color] will be available.

Tint

- 1) Press ▲ ▼ to select [Tint].
- 2) Press the <ENTER> button to display the adjustment dialog box.
- 3) Press ◀ ▶ to adjust the tint value to get a proper color balance.
 - Adjustments can be made between 0 and 63.

Note

- When you select [NTSC] or [NTSC4.43] in System menu under Video input signal, [Tint] will be available.

Iris

- 1) Press ▲ ▼ to select [Iris].
- 2) Press the <ENTER> button to display the adjustment dialog box.
- 3) Press ◀ ▶ to select [Off] or [On].

Off	Disabled
On	Contrast is prioritized over brightness

Color temp.

- 1) Press ▲▼ to select [Color temp.].
- 2) Press the <ENTER> button to display the adjustment dialog box.
- 3) Press ◀▶ to select the desired Color temp. level.
 - You can select the desired [Color temp.] from [XLow], [Low], [Mid] or [High].

Note

- [Color temp.] level displays [Blackbord] or [Colorboard] when the [Blackboard(Green)] or [Colorboard] is selected in the [Image select] menu.

Red

- 1) Press ▲▼ to select [Red].
- 2) Press the <ENTER> button to display the adjustment dialog box.
- 3) Press ◀▶ to adjust the setting value.

Operation	Adjustment	Adjustment range
Press ▶.	deepen red tone	Maximum value 63
Press ◀.	lighten red tone	Minimum value 0

Green

- 1) Press ▲▼ to select [Green].
- 2) Press the <ENTER> button to display the adjustment dialog box.
- 3) Press ◀▶ to adjust the setting value.

Operation	Adjustment	Adjustment range
Press ▶.	deepen green tone	Maximum value 63
Press ◀.	lighten green tone	Minimum value 0

Blue

- 1) Press ▲▼ to select [Blue].
- 2) Press the <ENTER> button to display the adjustment dialog box.
- 3) Press ◀▶ to adjust the setting value.

Operation	Adjustment	Adjustment range
Press ▶.	deepen blue tone	Maximum value 63
Press ◀.	lighten blue tone	Minimum value 0

Daylight View

This function uses an ambient light sensor to detect the room's light intensity and automatically adjust the projector output to ensure a bright presentation.

- 1) Press ▲▼ to select [Daylight View].
- 2) Press the <ENTER> button to display the adjustment dialog box.
- 3) Press ◀▶ to select the desired item.

Auto	Enables auto correction of [Daylight View]. The color sensor detects the brightness and color of the surroundings and automatically corrects the video display.
On	Enables [Daylight View].
Off	Disables [Daylight View].

Note

- When [Rear] is set to [On], [Auto] is disabled.
- When this function is set to [On] or [Auto], the [Sharpness] is disabled.

Image adjust

Sharpness

- 1) Press ▲ ▼ to select [Sharpness].
- 2) Press the <ENTER> button to display the adjustment dialog box.
- 3) Press ◀ ▶ to adjust the setting value.

Operation	Adjustment	Adjustment range
Press ▶.	increase the sharpness of the image	Maximum value 15
Press ◀.	decrease the sharpness of the image	Minimum value 0

Note

- When [Daylight View] is set to [On] or [Auto], the [Sharpness] is disabled.

Gamma

Adjust the gamma value to obtain a better balance of contrast.

- 1) Press ▲ ▼ to select [Gamma].
- 2) Press the <ENTER> button to display the adjustment dialog box.
- 3) Press ◀ ▶ to adjust the gamma value to obtain a better balance of contrast.
 - Adjustments can be made between 0 and 15.

Noise reduction

Reduces noise when viewing old video or other images affected by noise.

- 1) Press ▲ ▼ to select [Noise reduction].
- 2) Press the <ENTER> button to display the adjustment dialog box.
- 3) Press ◀ ▶ to select the desired item.

Off	Disabled
L 1	Lower reduction
L 2	Higher reduction

Note

- When input video signal to the projector, [Noise reduction] will become available.
- [Noise reduction] can not be selected when [480p], [576p], [720p], [1035i], [1080i], [D-480p], [D-576p], [D-720p], [D-1035i], [D-1080i], or [D-1080p] is selected in [System] Menu.

Progressive

An interlaced video signal can be displayed in progressive mode.

- 1) Press ▲ ▼ to select [Progressive].
- 2) Press the <ENTER> button to display the dialog box.
- 3) Press ◀ ▶ to select the desired item.

Off	Disabled
L 1	For an active picture
L 2	For a still picture
Film	For watching a film

Note

- When input video signal to the projector, [Progressive] will become available.
- [Progressive] can not be selected when [480p], [576p], [720p], [1035i], [1080i], [D-480p], [D-576p], [D-720p], [D-1035i], [D-1080i], or [D-1080p] is selected in [System] Menu.

Reset

To reset the adjusted data, all adjustments will return to their previous figures.

- 1) Press ▲ ▼ to select [Reset].
- 2) Press the <ENTER> button.
 - A confirmation box appears and then select [Yes].

Note

- To reset the adjusted data except [Daylight View].

Store

- 1) Press ▲ ▼ to select [Store].
- 2) Press ▶ or the <ENTER> button.
- 3) Press ▲ ▼ to select one from Image 1 to 4 and press the <ENTER> button.
 - A confirmation box appears and then select [Yes].

Note

- To store the adjusted data except [Daylight View].
- Make sure you selected [Store] after adjusting settings. Some settings can not be stored if not registered with Store function.

Screen

Select [Screen] from the Main Menu (see “Navigating through the menu” on page 37), then select the item from the sub-menu.

Remote Control

Control Panel

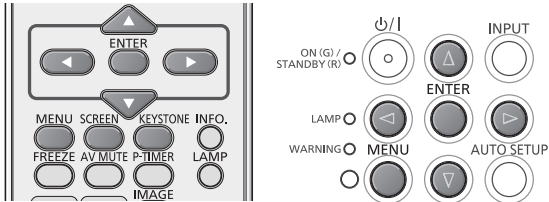

Note

- When [DIGITAL LINK] is selected, only [Normal] and [Custom] can be selected. Set the Aspect with the menu of the Digital Interface Box (Optional accessory: ET-YFB100G).

Normal

Provide the image to fit the screen size while maintaining the aspect ratio of the input signal.

Press ▲ ▼ to select [Normal] and then press the <ENTER> button.

Full

Provide the full screen image.

Press ▲ ▼ to select [Full] and then press the <ENTER> button.

Wide(16:9)

Provide the image at the 16:9 wide screen ratio.

Press ▲ ▼ to select [Wide(16:9)] and then press the <ENTER> button.

Note

- When [16:9] is selected in the [Screen aspect], [Wide (16:9)] cannot be selected.

Zoom

Scale the image proportionally to fit the entire screen. Either side of image may go over the screen.

Press ▲ ▼ to select [Zoom] and then press the <ENTER> button.

True

Provide the image in its original size. When the original image size is larger than the panel size, the projector enters to the panning mode automatically.

1) Press ▲ ▼ to select [True] and then press the <ENTER> button.

2) Press ▲ ▼ ◀ ▶ to pan the image.

- When adjusted, the arrows will turn red. When reached to the correction limits, the arrows will disappear.

Note

- When input computer signal to the projector, [True] will be available. Projector image may be distorted due to different computers or different input signals.
- When input computer signal to the projector, [True] is disabled and cannot be selected when [480p], [480i], [576p], [576i], [720p], [1035i] or [1080i] is selected in [System] Menu.
- When [True] is selected in the Screen menu, [Digital zoom +/-] cannot be selected.

Natural wide

Modify the 4:3 aspect ratio image to fit the screen size by stretching the image to make it look natural.

Press ▲ ▼ to select [Natural wide] and then press the <ENTER> button.

Note

- When input video signal to the projector, [Natural wide] will be available.
- When [4:3] is selected in the [Screen aspect], [Natural wide] cannot be selected.
- [Natural wide] is not available when [720p], [1035i] or [1080i] is selected in the System Menu.

Custom

Provide the last stored aspect screen image.

Press ▲ ▼ to select [Custom] and press the <ENTER> button.

Screen

Custom adj.

Adjust the screen scale and position manually with this function.

- 1) Press ▲ ▼ to select [Custom adj.].
- 2) Press ► or the <ENTER> button to enter the next submenu.
- 3) Press ▲ ▼ to choose the item you want to adjust.
 - You can choose one from the items as below:

Scale H/V	Adjust the Horizontal/Vertical screen scale.
H&V	When set to [On], the aspect ratio is fixed.
Position H/V	Adjust the Horizontal/Vertical screen position.
Common	Save the adjusted scale or position to all the inputs.
Reset	Reset the all adjusted values.

Digital zoom +

Zoom in the images.

- 1) Press ▲ ▼ to select [Digital zoom +] and then press the <ENTER> button.
 - The On-Screen Menu disappears and [D. zoom +] appears.
- 2) Press the <ENTER> button to zoom in the image size and press ▲ ▼ ◀▶ to move the image to the top/bottom/left/right of the screen.
 - The Panning function can work only when the image is larger than the screen size. A projected image can be also expanded by pressing the <D.ZOOM +> or the <ENTER> button.

Digital zoom –

Zoom out the images.

- 1) Press ▲ ▼ to select [Digital zoom –] and then press the <ENTER> button.
 - The On-Screen Menu disappears and [D.zoom –] appears.
- 2) Press the <ENTER> button to zoom out image size.
 - The projected image can be also compressed by pressing the <D.ZOOM –> or the <ENTER> button.

To exit the Digital zoom +/- mode, press any button except the <D.ZOOM +/->, <ENTER> and ▲ ▼ ◀▶ buttons.

To return to the previous screen size, select a screen size from the Screen Size Adjustment Menu or select an input source from the Input Source Selection Menu (➔page 40) again, or adjust the screen size with the <D.ZOOM +/-> buttons.

Note

- When input computer signal to the projector, [Digital zoom +/-] will be available.
- [Digital zoom +/-] cannot be selected when [True] is selected in the Screen menu.
- [Digital zoom -] cannot be adjusted when [Custom] is selected in the Screen menu and image is normal.
- [Digital zoom +/-] are disabled and cannot be displayed when [480i], [576i], [480p], [576p], [720p], [1035i] or [1080i] is selected in the PC System Menu (➔page 40).
- When Digital zoom +/- functions are disabled, ! mark will appear.

Keystone

This function is used to adjust keystone distortion of the projected image.

- 1) Press ▲ ▼ to select [Keystone].
- 2) Press ► or the <ENTER> button.
- 3) Press ▲ ▼ to choose the item you want to adjust.

Keystone	To correct keystone distortion
Store	To store or reset the keystone correction



The following items are the submenu of [Store].

Store	Keep the keystone correction even when the AC power cord is plugged out or turned off the projector.
Reset	Release the keystone correction when the AC power cord is plugged out.

Note

- For more details about the keystone correction, refer to "Using the KEYSTONE button" (➔page 34).

Ceiling

This function is used to project the image from a ceiling-mounted projector.

- 1) Press ▲▼ to select [Ceiling] and then press the <ENTER> button.
- 2) Press ▲▼ to change the image.
 - When this function is set to [On], the picture will be top/bottom and left/right reversed.

Rear

This function is used to project the image from rear of the screen.

- 1) Press ▲▼ to select [Rear] and then press the <ENTER> button.
- 2) Press ▲▼ to change the image.
 - When this function is set to [On], the picture will be left/right reversed.

Screen aspect

This function is used to project the image to a 4:3 or 16:9 projection screen.

- 1) Press ▲▼ to select [Screen aspect] and then press the <ENTER> button.
- 2) Press ▲▼ to choose one from the items as below.

Default(16:10)	16:10 is the aspect of the LCD panel.
16:9	Set to a 16:9 projection screen.
4:3	Set to a 4:3 projection screen.

Note

- When the 4:3 function is selected, [Natural wide] is not available in the AV screen.
- When the 16:9 function is selected, [Wide (16:9)] is not available in the AV screen.

Reset

To reset the adjusted data, all adjustments will return to their previous figures.

Press ▲▼ to select [Reset] and then press the <ENTER> button.

- A confirmation box appears and then select [Yes].

Sound

Select [Sound] from the Main Menu (see “Navigating through the menu” on page 37), then select the item from the sub-menu.

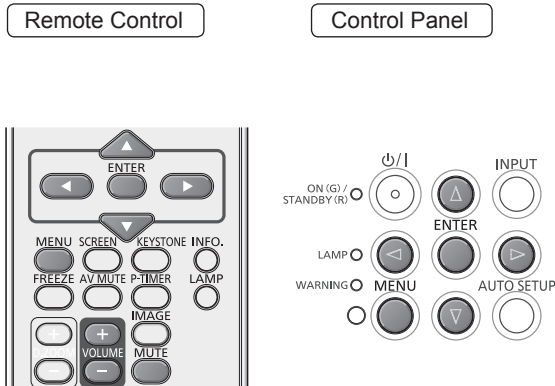

Volume

- 1) Press ▲ ▼ to select [Volume] and then press the <ENTER> button.
- 2) Press ◀ ▶ to adjust the volume.
 - Press <ENTER> button to set the volume.

Operation	Adjustment	Adjustment range
Press ▶.	turn up the volume	Maximum value 63
Press ◀.	turn down the volume	Minimum value 0

- You can press <VOLUME +/-> buttons on the remote control to adjust the volume. Also you can press the ◀ ▶ on the control panel to adjust the volume when menu is off.

Mute

- 1) Press ▲ ▼ to select [Mute].
- 2) Press the <ENTER> button to switch the mute function [On]/[Off].
 - Press the <MUTE> button on the remote control also can switch the mute function On/Off. (▶page 36)

MIC

- 1) Press ▲ ▼ to select [MIC] and then press the <ENTER> button.
- 2) Press ▲ ▼ to switch the MIC function [On]/[Off].
 - When [Off] is selected in [MIC], the [MIC gain] is not available.
 - Connect the computer 2 audio input signals to COMPUTER AUDIO IN 1 terminal as the MIC function is turned on.
 - If the MIC function is turned on when connecting PC audio to the AUDIO IN (a mini jack), loud sound may be output suddenly depending on the setting value of [MIC gain].

MIC gain

- 1) Press ▲ ▼ to select [MIC gain] and then Press the <ENTER> button.
- 2) Press ◀ ▶ to adjust the MIC mixing gain.
 - Press <ENTER> button to set the [MIC gain].

Operation	Adjustment	Adjustment range
Press ▶.	turn up the MIC mixing gain	Maximum value 63
Press ◀.	turn down the MIC mixing gain	Minimum value 0

In standby mode

This function is used to switch the output sound On/Off at standby mode.

- 1) Press ▲ ▼ to select [In standby mode] and then press the <ENTER> button.
- 2) Press ▲ ▼ to switch [On]/[Off].
 - When setting the In standby mode function to [On] and in Standby mode status, sound volume can be adjusted with ◀ ▶ buttons on the control panel or <VOLUME +/-> buttons on the remote control.
 - [MIC] is set to [On] to output MIC sound at standby mode status.
 - Only the [Standby mode] is set to [Network], [In standby mode] can be selected.

Setting

Select [Setting] from the Main Menu (see “Navigating through the menu” on page 37), then select the item from the sub-menu.

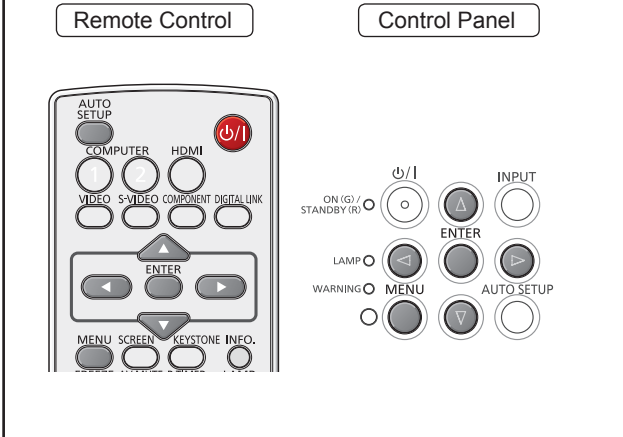

Language

- 1) Press ▲▼ to select [Language].
- 2) Press ► or the <ENTER> button.
- 3) Press ▲▼ to select the desired language.

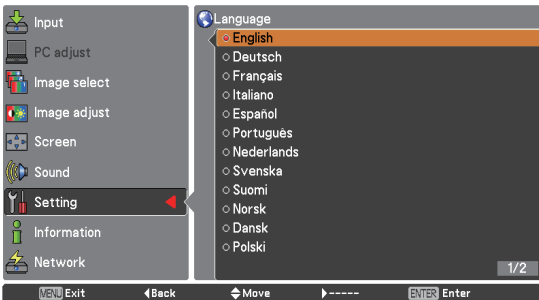
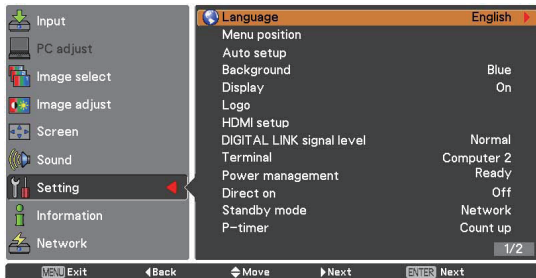

- The language used in the On-Screen Menu is available in English, German, French, Italian, Spanish, Portuguese, Dutch, Swedish, Finnish, Norwegian, Danish, Polish, Hungarian, Romanian, Czech, Russian, Turkish, Arabic, Kazak, Vietnamese, Chinese, Korean, Japanese and Thai.

Menu position

This function is used to change the position of the On-Screen Menu.

- 1) Press ▲▼ to select [Menu position].
- 2) Press the <ENTER> button to change the position.

- The Menu position changes each time you press <ENTER> button as follows:

the center → the bottom left → the bottom right → the top left → the top right → the center.....

Auto setup

- 1) Press ▲▼ to select [Auto setup].
- 2) Press ► or the <ENTER> button.
- 3) Press ▲▼ to select these functions as follows:

Input search

This function detects the input signal automatically. When a signal is found, the search will stop.

Off	Input search will not work
On 1	Input search works*1
On 2	Input search works*2

- *1 : • When pressing the <AUTO SETUP> button on the remote control or the control panel.
- *2 : • When turning on the projector by pressing the <ON/OFF> button on the remote control or the control panel.
- When pressing the <AUTO SETUP> button on the remote control or the control panel.
 - When the current input signal is cut off.*
- * If the AV mute or Freeze function is active, cancel it to activate the Input search. It is also unavailable when On-Screen menu is displayed.

Auto PC adj.

On	Enables Auto PC adjustment *1
Off	Disables Auto PC adjustment

- *1 : When pressing the <AUTO SETUP> button on the remote control or the control panel.

Auto keystone

Auto	Always works and corrects keystone distortion according to the projector's tilt.
Manual	Works only when pressing the <AUTO SETUP> button on the remote control or the control panel.
Off	Disables Auto Keystone.

Note

- [Input search], [Auto PC adj.] and [Auto Keystone] cannot be set [Off] at the same time.
- The Auto Keystone function cannot work when the [Ceiling] feature is set [On] in the [Screen] menu.

Setting

Background

Select the background screen for when no input signal is detected.

- 1) Press ▲ ▼ to select [Background].
- 2) Press the <ENTER> button.
- 3) Press ▲ ▼ to switch each option as below.

Blue	Blue colored background.
User	The logo transferred by "Logo Transfer Software *1 " is projected.
Black	Black colored background.

*1 : "Logo Transfer Software" is included on the supplied CD-ROM.

Display

This function decides whether to display On-Screen Displays.

- 1) Press ▲ ▼ to select [Display].
- 2) Press the <ENTER> button.
- 3) Press ▲ ▼ to switch between each option as below.

On	Show all the On-Screen displays *1
Countdown off	Show the input image instead of the countdown when turning on the projector *2
Off	Hide the On-Screen Displays *3

*1 : Use this function when you want to project images after the lamp becomes bright enough. The factory default setting is in this option.

*2 : Use this function when you want to project the image as early as possible even when the lamp is not bright enough.

- *3 : Hide the On-Screen Displays except;
- On-Screen Menu.
 - [Power off?]
 - [P-timer] display.
 - No signal for [Power management]
 - [Please wait ...]
 - Arrows for the True function in the [Screen] Menu.
 -  [Service]

Logo

This function allows you to customize the screen logo with Logo select, Logo PIN code lock and Logo PIN code change functions.

- 1) Press ▲ ▼ to select [Logo].
- 2) Press ► or the <ENTER> button.
- 3) Press ▲ ▼ to choose the desired item.

■ Logo select

This function decides on the starting-up display from among following options.

Off	Show the countdown display only.
Default	Show the factory-set logo.
User	The logo transferred by "Logo Transfer Software *1 " is projected.

*1 : "Logo Transfer Software" is included on the supplied CD-ROM.

■ Logo PIN code lock

This function prevents an unauthorized person from changing the screen logo.

Off	The screen logo can be changed freely from the Logo Menu.
On	The screen logo cannot be changed without a Logo PIN code.

Note

- If you want to change the Logo PIN code lock setting, press the <ENTER> button and the Logo PIN code dialog box appears. Enter a Logo PIN code by following the steps below. The initial Logo PIN code is set to "4321" at the factory.

Enter a logo PIN code

Press ▲ ▼ buttons to enter a number from 0-9. Press ► button to fix the number and move the red frame pointer to the next box. The number changes to *. Repeat this step to complete entering a four-digit number. After entering the four-digit number, press ► button to move the pointer to "Set" and then a [OK?] confirmation box appears, select [Yes] and then press <ENTER> button.

- If you fixed an incorrect number, use the ◀ button to move the pointer to the number you want to correct, and then enter the correct number with the ▲ ▼ buttons.
- If you entered an incorrect PIN code, PIN code and the number (****) will turn red for a moment. Enter the correct PIN code all over again.

■ Logo PIN code change

Logo PIN code can be changed to your desired four-digit number.

- 1) Press ▲ ▼ to select [Logo PIN code change] and press the <ENTER> button.
 - Current logo PIN code dialog box appears.

2) Press ▲▼ to enter the current code, press the ► button to fix the number and move the red frame pointer to the next box.

- The New Logo PIN code input dialog box appears.

3) Repeat this step to set the new Logo PIN code.

Attention

- Be sure to note the new Logo PIN code and keep it on hand. If you lost the number, you could no longer change the Logo PIN code setting.

HDMI setup

This function is only used for HDMI input source.

1) Press ▲▼ to select [HDMI setup].

2) Press ► or the <ENTER> button.

- The names for the output setting of Digital R/G/B vary from equipment to equipment.

Image

Normal	When the output of external equipment is set to Standard.
Enhanced	When the output of external equipment is set to Enhanced.

Sound

HDMI	When Digital input source is input, Sound is set to HDMI.
Computer 2	When DVI input source is changed to HDMI input source, Sound is set to Computer 2.

Note

- The optimum setting depends on the setting of the external equipment. For details, refer to the operating instructions of your external equipment.
- Connect the computer 2 audio input signals to COMPUTER AUDIO IN 1 terminal as Sound function is set to Computer 2 and MIC function is turned on.

DIGITAL LINK signal level

To set the signal level when the DIGITAL LINK input is selected.

1) Press ▲▼ to select [DIGITAL LINK signal level] and then press the <ENTER> button.

2) Press ▲▼ to switch the item.

Normal	When the output of external equipment connected to <DIGITAL LINK> terminal is set to Standard.
Enhanced	When the output of external equipment connected to <DIGITAL LINK> terminal is set to Enhanced.

Note

- The optimum setting depends on the setting of the external equipment. For details, refer to the operating instructions of your external equipment.

Terminal

The COMPUTER 2 IN/MONITOR OUT terminal on the back of the projector is switchable for computer 2 input or monitor output.

1) Press ▲▼ to select [Terminal] and then press the <ENTER> button.

2) Press ▲▼ to switch the item.

Computer 2	Computer input
Monitor out	Monitor out

Note

- Terminal function is not available when selecting [Computer 2] to the input source. Change the input source to the others (HDMI, Computer 1, Video, DIGITAL LINK or S-Video) so that the Terminal function will be available.

Power management

For reducing power consumption as well as maintaining the lamp life, the Power management function turns off the projection lamp when the projector is not operated for a certain period.

1) Press ▲▼ to select [Power management].

2) Press ► or the <ENTER> button to access the submenu.

Mode

1) Press ▲▼ and then press the <ENTER> button to select one mode among the items as below.

Setting

Off	Power management function is off.
Ready	When the lamp has been fully cooled down, the <ON(G)/STANDBY(R)> indicator changes to green blinking. In this condition, the projection lamp will be turned on if the input signal is reconnected or any button on the control panel or remote control is pressed.
Shut down	When the lamp has been fully cooled down, the power will be turned off.

■ Timer

- 1) Press ▲ ▼ to select [Timer] and then press the <ENTER> button.
- 2) Press ▲ ▼ to set the Timer(1~30 min).

Direct on

- 1) Press ▲ ▼ to select [Direct on] and then press the <ENTER> button.
- 2) Press ▲ ▼ to switch between [On] and [Off].

- When this function is set to [On], the projector will be automatically turned on just by connecting the AC power cord to a wall outlet.
- Be sure to turn off the projector properly. If the projector is turned off in the incorrect sequence, the Direct On function does not work properly.

Standby mode

This function can set the electric power when the projector is standing by.

- 1) Press ▲ ▼ to select [Standby mode] and then press the <ENTER> button.
- 2) Press ▲ ▼ to switch between the items as below.

Eco	Restricts some functions in standby mode to reduce power consumption.
Network	Does not restrict functionality even in standby mode.

Note

- When selecting [Network], the cooling fans may be running depending on the temperature inside the projector even if the projector is turned off.
- If Standby mode is set to [Eco], you cannot use network functions when the projector is standing by. Also, you cannot use some RS-232C protocol commands.

- If set to [Network], you can use network functions when the projector is standing by.
- If [Standby mode] is set to [Eco], the signal come from MONITOR OUT and VARIABLE AUDIO OUT terminals are unavailable.

P-timer

This function allows you to change the setting of the P-timer and execute it.

- 1) Press ▲ ▼ to select [P-timer].
- 2) Press ► or <ENTER> button to access the submenu.

■ Mode

- 1) Press ▲ ▼ button to select one mode among the items as below.

Count up	The P-timer display 000:00 appears on the screen and the count up starts (000:00-180:00).
Count down	The time set in the Timer setting appears on the screen and the countdown starts.

■ Timer

- 1) Press ▲ ▼ to select [Timer] and then press the <ENTER> button.
- 2) Press ▲ ▼ to set the [Timer](1-180 min).
 - Timer is available in [Count down] only. Factory default value is 10 min.

■ Execute

- 1) Press ▲ ▼ to select one among the items as below and then press the <ENTER> button.

Start	It executes the count up or count down function.*1
Reset	Reset the P-timer values.*2
Exit	To exit the P-timer operation.

*1 : Press the <ENTER> button at [Start] and the indication changes into [Stop]. To stop Count up or Count down, press the <ENTER> button at [Stop] on the screen menu, then the indication changes into [Restart]. Press the <ENTER> button at [Restart] to resume Count up or Count down.

*2 : Press the <ENTER> button at [Reset] to return to the following value:

Count up	"000:00"
Count down	Timer that you set

Note

- To stop the P-timer function, press the <P-TIMER> button.
- To cancel the [P-timer], press and hold the <P-TIMER> button for a few seconds.

Closed caption

[Only for NTSC, 480i input]

- 1) Press **▲ ▼** to select [Closed caption].
- 2) Press **▶** or the <ENTER> button to enter the submenu.

■ Closed caption

- 1) Press **▲ ▼** to select [Closed caption] and then press the <ENTER> button.
- 2) Press **▲ ▼** to select [Off], [CC1], [CC2], [CC3] or [CC4].

■ Color

- 1) Press **▲ ▼** to select [Color] and then press the <ENTER> button.
- 2) Press **▲ ▼** to select [color] or [white].



Attention

- The closed caption is mainly used in the north America. This function shows the text information contained in the image signal. Captions may not be displayed on some devices or software.
- You can select [Closed caption] when matching signals for the closed caption are input.
- Part of characters may not displayed when high compensation values are set in [Keystone].
- Closed captions will not be displayed while the menu screen, P-timer or other items appear.

Lamp power

This function allows you to change brightness of the screen.

- 1) Press **▲ ▼** to select [Lamp power] and then press the <ENTER> button .
- 2) Press **▲ ▼** to select one among the modes as below.
 - You can also press the <LAMP> button to display [Lamp power].

 Normal	Normal brightness.
 Eco	Lower brightness reduces the lamp power consumption and extends the lamp life.

Note

- If [Lamp power] is set to [Normal] and the operating environment temperature exceeds 35 °C (95 °F), [Lamp power] may be changed to [Eco] automatically.

Remote control

This switching function prevents remote control interference when operating several projectors or video equipment at the same time.

- 1) Press **▲ ▼** to select [Remote control].
- 2) Press **▶** or the <ENTER> button.
- 3) Press **▲ ▼** to select one among the seven codes.
 - This projector provides 7 different remote control codes: [ALL], [Code 1]~[Code 6].

Attention

- When operating the projector under [ALL] code, you can operate several projectors at the same time. If you want to operate the projector independently, you must switch to other code.
- When different codes are set on the projector and on the remote control, any operation cannot be made. In that case, switch the code on the remote control to fit the code on the projector.
- If the batteries are removed from the remote control for a long period of time, the remote control code will be reset.

Security

This function allows you to use the Key lock and PIN code lock function to set the security for the projector operation.



- 1) Press **▲ ▼** to select [Security].
- 2) Press **▶** or the <ENTER> button to access the submenu.

■ Key lock

This function locks the control panel and remote control buttons to prevent operation by unauthorized persons.

Setting

- 1) Press ▲▼ to select the desired items as below.

	Unlocked.
	Lock the operation of the control panel. To unlock, use the remote control.
	Lock the operation of the remote control. To unlock, use the control panel.

■ PIN code lock

This function prevents the projector from being operated by unauthorized persons and provides the following setting options for security.

- 1) Press ▲▼ to select the desired items as below.

Off	Unlocked.
On 1	Enter the PIN code every time turning on the projector.
On 2	Enter the PIN code to operate the projector once the power cord is disconnected; as long as the AC power cord is connected, the projector can be operated without a PIN code.

Attention

- Whenever you change the PIN code lock setting or the PIN code (the four-digit number), you are required to enter the PIN code. The "1234" is set as the initial PIN code at the factory.

Enter a PIN code

Press ▲▼ buttons to enter a number from 0-9. Press ► button to fix the number and move the red frame pointer to the next box. The number changes to *. Repeat this step to complete entering a four-digit number.

After entering the four-digit number, press ► button to move the pointer to "Set" and then a [OK?] confirmation box appears, select [Yes] and then press <ENTER> button.

- If you fixed an incorrect number, use the ◀ button to move the pointer to the number you want to correct, and then enter the correct number with the ▲▼ buttons.
- If you entered an incorrect PIN code, PIN code and the number (****) will turn red for a moment. Enter the correct PIN code all over again.

■ PIN code change

The PIN code can be changed to your desired four-digit number.

- 1) Press ▲▼ to select [PIN code change] and then press <ENTER> button.
- Current Pin code dialog box appears.

- 2) Press ▲▼ to enter the current code. Press ► button to fix the number and move the red frame pointer to the next box.

- The New PIN code input dialog box appears.

- 3) Repeat these steps to set a new PIN code.

Attention

- Be sure to note the new PIN code and keep it on hand. If you lost the number, you could no longer change the PIN code setting.

Fan

- 1) Press ▲▼ to select [Fan] and then press <ENTER> button.

- 2) Press ▲▼ to select one option .

- This function provides the following options in the cooling fans' operation when the projector is turned off.

L 1	Higher-sound than L 2 mode and it takes less time to cool the projector down.
L 2	Slower and lower-sound than L 1 mode, but it takes more time to cool the projector down.

Fan control

- 1) Press ▲▼ to select [Fan control] and then press <ENTER> button.

- 2) Press ▲▼ to select one among options as below.

- Choose the running speed of cooling fans from the following options according to the ground elevation under which you use the projector.

Off	Normal speed.*1
On 1	Faster than [Off] mode.*2
On 2	Faster than [On 1] mode.*3

*1 : Set this function to [Off] when using the projector in non-high altitude environment.

*2 : When using the projector in the elevation of above 1 200 m and below 2 000 m, make sure [Fan control] is set to [On 1].

*3 : When using the projector in the elevation of above 2 000 m and below 2 700 m, make sure [Fan control] is set to [On 2].

Note

- Failure to set the running speed of cooling fans properly may affect the projector life.
- The fan noise becomes louder in [On 1] and [On 2].

Video delay control

This function allows you to make a digital processing of a projected image faster.

- 1) Press **▲▼** to select [Video delay control] and then press the **<ENTER>** button.
- 2) Press **▲▼** to select one item between [On] and [Off].

Note

- [Noise reduction] and [Progressive] can not be selected when Video delay control function is set to [On].

Filter counter

This function is used to set a frequency for the filter replacement.

- 1) Press **▲▼** to select [Filter counter].
- 2) Press **▶** or the **<ENTER>** button to access the submenu items.

Filter counter

Show the total accumulated time of the filter use timer setting.

Timer

To set a timer. When the projector reaches the selected time the filter warning icon  appears on the screen.

- 1) Press **▲▼** to select [Timer] and then press the **<ENTER>** button.
- 2) Press **▲▼** to set the Timer.
 - Select from [Off/1000 H/2000 H/3000 H/4000 H/5000 H/6000 H] depending on the use environment.

Filter counter reset

After replacing the filter, be sure to reset the timer.

- 1) Press **▲▼** to select [Filter counter reset].
- 2) Press the **<ENTER>** button.
 - [Filter counter Reset?] appears. Select [Yes] to continue. Another confirmation dialog box appears, select [Yes] to reset the [Filter counter].

Emulate

When using the control commands for one of our projectors that you have previously purchased to control this projector using a computer via its [SERIAL IN] terminal, set up the Emulate function as follows. This will allow you to use the control software etc. designed for our existing projectors.

- 1) Press **▲▼** to select [Emulate].
- 2) Press the **<ENTER>** button or the **▶** button.
 - The [Emulate] screen appears.
- 3) Press **▲▼** to select the required item.
- 4) Press the **<ENTER>** button.

Note

- For the communication conditions of the Baud rate, refer to "Serial terminal". (▶page 90)

Default	VW431D series
D3500	D3500 series
D4000	D4000 series
D/W5k series	D5500 series, DW5000 series, D5600 series, DW5100 series, D5700 series
D/W/Z6k series	D5000 series, D6000 series, DW6300 series, DZ6700 series, DZ6710 series, DZ570 series, DW530 series, DX500 series
L730	L520 series, L720 series, L730 series
L780	L750 series, L780 series
L735	L735 series
L785	L785 series
LB/W series	LB2 series, LB1 series, LB75 series, LB80 series, LB90 series, ST10 series
F/W series	FX400 series, FW430 series, F100 series, FW100 series, F200 series, F300 series, FW300 series
LZ370	LZ370 series
VX/VW series	VX400 series, VX400NT series, VW330 series, VX41 series, VW430 series, VX500 series, VW435N series, VX505N series

Setting

RS232C

Switch the sending and receiving port of the serial command.

- 1) Press ▲ ▼ to select [RS232C] and then press the <ENTER> button.
- 2) Press ▲ ▼ to switch the item.

Serial	For the projector SERIAL IN terminal.
DIGITAL LINK	For the Digital Interface Box SERIAL IN terminal (Optional accessory: ET-YFB100G).

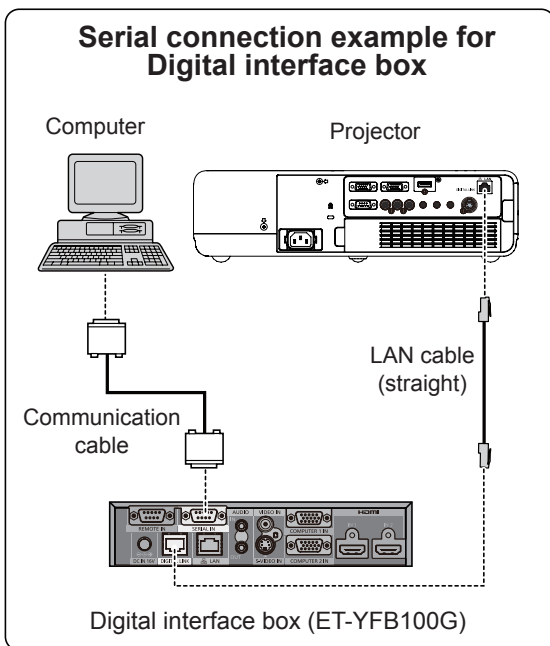

Note

- When [DIGITAL LINK] is selected, the signal can only be transmitted when connects the <DIGITAL LINK> jack of the projector to the SERIAL terminal of the connected equipment, such as the Digital Interface Box (Optional accessory: ET-YFB100G).
- When you want to transfer the logo via Digital Interface Box (ET-YFB100G), [NO SIGNAL SLEEP] should be set to [Off] for the communication will be not interrupted.

Warning log

This function records anomalous operations while the projector is in operation and use it when diagnosing faults.

- 1) Press ▲ ▼ to select [Warning log].
- 2) Press ► or the <ENTER> button to display the latest warning message.
 - Up to 10 warning logs are displayed with the latest warning message at the top of the list, followed by previous warning messages in chronological order.

Attention

- When the Factory default function is executed, all the warning log records will be deleted.

Factory default

This function returns all setting values except for [PIN code lock], [Logo PIN code lock], [Lamp power], [Filter counter] and all of the network settings to the factory default settings.

- 1) Press ▲ ▼ to select [Factory default].
- 2) Press the <ENTER> button.
 - [Return to Factory default?] appears. Select [Yes] to continue. Another confirmation dialog box appears, select [Yes] to return to [Factory default].

Information

Select [Information] from the Main Menu (see “Navigating through the menu” on page 37).

Remote Control

Control Panel

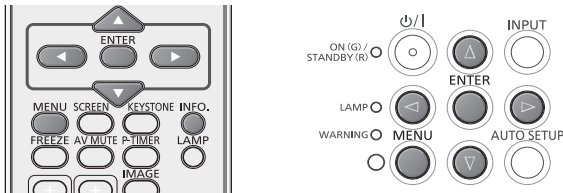

Input Source Information Display

The Information Menu is used for checking the status of the image signal being projected and the operation of the projector.

You can also Press the <INFO.> button on the remote control to display the Information menu.

Press ◀▶ to switch between page 1 and page 2.

■ Input

The selected input source is displayed.

■ System

The selected system is displayed.

■ H-sync freq.

The selected H-sync freq. is displayed.

The horizontal frequency of the input signal is displayed in kHz, or - - - - kHz when no signal.

■ V-sync freq.

The selected V-sync freq. is displayed.

The vertical frequency of the input signal is displayed in Hz, or - - - - Hz when no signal.

■ Screen

The selected Screen size is displayed.

■ Language

The selected language is displayed.

■ Lamp power

The selected lamp mode is displayed.

■ Lamp runtime

The cumulative lamp operating time is displayed.

■ Power management

[Off], [Ready] or [Shut down], and [Timer] are displayed.

■ Key lock

The selected Key lock icon is displayed.

■ PIN code lock

[Off], [On 1] or [On 2] is displayed.

■ Remote control

The selected remote control code is displayed.

■ Serial number

The serial number of the projector is displayed.

The serial number is used to service the projector.

Network

Select [Network] from the Main Menu (see “Navigating through the menu” on page 37), then select the item from the sub-menu.

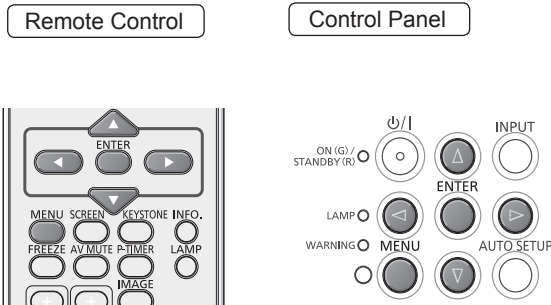

DIGITAL LINK mode

You can switch the DIGITAL LINK function mode among Auto, DIGITAL LINK and Ethernet.

- 1) Press ▲▼ to select [DIGITAL LINK mode].
- 2) Press <ENTER> button and press ▲▼ to select items.

Auto	To select the automatically response communication method.
DIGITAL LINK	To select the DIGITAL LINK.
Ethernet	To select the Ethernet.

Communication availability of all settings

Settings	Communication availability		
	Image, Sound	Ethernet	RS-232C
Auto	○	○	○
DIGITAL LINK	○	○	○
Ethernet	✕	○	✕

Note

- To carry out Ethernet communication with optional accessory Digital interface box (ET-YFB100G), please set to [Auto] or [DIGITAL LINK].
- If set to [Ethernet], communication can not be carried out with ET-YFB100G because the [LAN/DIGITAL LINK] terminal is only for NETWORK communication.

DIGITAL LINK setup

You can make detailed DIGITAL LINK settings among Duplex (Ethernet), Duplex (DIGITAL LINK) and Store.

- 1) Press ▲▼ to select [DIGITAL LINK setup].

- 2) Press <ENTER> button or the ► button to access to the submenu.

■ Duplex (Ethernet)

Set the method of communication of the computer or hub.

- 1) Press ▲▼ to select [Duplex (Ethernet)] and press <ENTER> button.
- 2) Press ▲▼ to switch the settings.

Autonegotiation	Communication method will be set automatically.
100 Base TX-Full	Full Duplex communication method will be set.
100 Base TX-Half	Half Duplex communication method will be set.

■ Duplex (DIGITAL LINK)

Set the communication method between the Twisted pair cable Extender and the computer or the Hub.

- 1) Press ▲▼ to select [Duplex (DIGITAL LINK)] and press <ENTER> button.
- 2) Press ▲▼ to switch the settings.

Autonegotiation	Communication method will be set automatically.
100 Base TX-Full	Full Duplex communication method will be set.
100 Base TX-Half	Half Duplex communication method will be set.

■ Store

Store the settings.

- 1) Press ▲▼ to select [Store].
- 2) Press <ENTER> button.
 - A confirmation box appears and then select [Yes].

DIGITAL LINK status

You can check detailed setting information of DIGITAL LINK.

- 1) Press ▲▼ to select [DIGITAL LINK status].
- 2) Press <ENTER> button to display the Mode, the HDMI Status and the Signal quality information.
 - Link state, HDMI status and signal quality are displayed.

Mode	[No link], [DIGITAL LINK], [LPM] or [Ethernet] appears.
HDMI status	[NO HDMI], [HDMI ON] or [HDCP ON] appears.

The color of [Signal quality] will change to red, yellow or green depending on the maximum and minimum data of the ERROR value.

Signal quality	Color	Status
less than -12 dB	Green	Normal signal received
-11 ~ -8 dB	Yellow	Part of the received data destroyed
more than -7 dB	Red	Abnormal signal received

Projector name

You can change the projector name to be displayed on the network.

- 1) Press **▲▼** to select [Projector name], and press **<ENTER>** button.
- 2) Select characters with the **▲▼◀▶** buttons and press the **<ENTER>** button to enter the projector name.
Select [BS] to delete one character selected with the cursor in the input box and press the **<ENTER>** button.
- 3) Select [Set] with the **▲▼◀▶** buttons and press the **<ENTER>** button.
Select [Cancel] to undo the changes and then press the **<ENTER>** button.
- 4) Select [Yes] or [No] with the **▲▼** buttons and press the **<ENTER>** button.

Note

- [Name □□□□] (□□□□ is four-digit number) is set before the projector leaves the factory.

Network setup

You can make detailed wired LAN settings.

- 1) Press **▲▼** to select [Network setup], and press **<ENTER>** button.
- 2) Press **▲▼** to select an item, and change the setting according to the instructions.

DHCP (DHCP client function)	On: If a DHCP server exists in the network to which the projector is connected, the IP address will automatically be acquired. Off: If a DHCP server does not exist in the network to which the projector is connected, additionally set [IP address], [Subnet mask] and [Default gateway].
IP address (Displaying and setting the IP address)	Enter the IP address if DHCP server is not used.
Subnet mask (Displaying and setting the subnet mask)	Enter the the Subnet mask if not using a DHCP server.
Default gateway (Displaying and setting the gateway address)	Enter the gateway address if DHCP server is not used.
DNS1 (Displaying and setting the preferred DNS server address)	Enter the DNS server address if DHCP server is not used.
DNS2 (Displaying and setting the alternate DNS server address)	Enter the alternate DNS server address if DHCP server is not used.

- 3) Press **▲▼◀▶** to select [Set], and press **<ENTER>** button.

- Default wired LAN settings
The following settings are set before the projector leaves the factory.

DHCP	Off
IP address	192.168.10.100
Subnet mask	255.255.255.0
Default gateway	192.168.10.1
DNS1/DNS2	NONE

Note

- Before using the DHCP server, make sure the DHCP server is already functioning.
- For details of IP address, subnet mask, gateway and DNS, ask the network administrator.

Network

Network control

Set when you want to control the projector from a computer connected to the network.

- 1) Press ▲▼ to select [Network control].
- 2) Press <ENTER> button to select [On] or [Off] with the ▲▼ buttons.

Network status

This function shows the LAN setting environment of the currently selected projector.

- 1) Press ▲▼ to select [Network status].
- 2) Press <ENTER> button or the ► button to show the information of the current projector status.

AMX D.D.

This function allows the projector to be detected by AMX Device Discovery. For more details, visit the following website.

<http://www.amx.com/>

- 1) Press ▲▼ to select [AMX D.D.].
- 2) Press <ENTER> button to select [On] or [Off] with the ▲▼ buttons.

RoomView

This function allows the projector to monitor and control the projector through network with Crestron RoomView.

- 1) Press ▲▼ to select [RoomView].
- 2) Press <ENTER> button to select [On] or [Off] with the ▲▼ buttons.

This projector supports the following application software from Crestron company.

- RoomView Express
- Fusion RV
- RoomView Server Edition

"Crestron RoomView" is a system developed by Crestron Electronics, Inc. which collectively manage and control multiple system devices connected via the network, from a computer. This projector supports "Crestron RoomView".

- For details of "Crestron RoomView", refer to the Crestron Electronics, Inc. website (Provided only in English).
<http://www.crestron.com/>
For the download of "RoomView Express", refer to the Crestron Electronics, Inc. website (Provided only in English).
<http://www.crestron.com/getroomview>

Extron XTP

To carry out connection settings with XTP Transmitter made by Extron. Visit the following website for details.
<http://www.extron.com>

- 1) Press ▲▼ to select [Extron XTP].
- 2) Press <ENTER> button to select [On] or [Off] with the ▲▼ buttons.

Digital Interface Box

Display the Setup menu of the Digital Interface Box.

- 1) Press ▲▼ to select [Digital Interface Box] and press <ENTER> button.
 - Switch to the menu of Digital Interface Box.

Note

- This function can be selected when Digital interface box (ET-YFB100G) is connected to <DIGITAL LINK> terminal.
- [RETURN] button will display in the operation GUIDE of the Digital Interface Box MENU. In this projector, the [MENU] button equals to [RETURN] button.
- This function is unavailable when [Extron XTP] is set to [On].

Network factory default

You can reset the network setting to the factory default of the projector.

- 1) Press ▲▼ to select [Network factory default], and press <ENTER> button.
- 2) A confirmation box appears and select [Yes] and then press <ENTER> button.
- 3) Another confirmation box appears and select [Yes] and then press <ENTER> button.

Network connections

The projector has a network function, and the following operations are available from the computer using the web browser control.

- Setting and adjustment of the projector.
- Display of the projector status.
- Transmission of an E-mail message when there is a problem with the projector.

Note

- A LAN cable is required to use the network function.

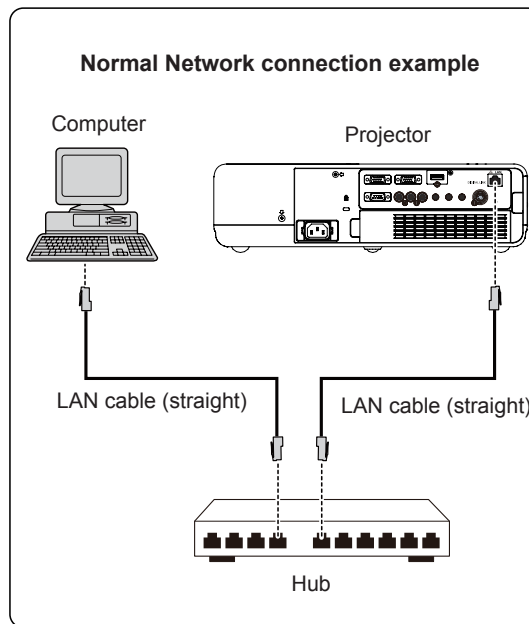

Notes on LAN network connections

- A Web browser is required to use this function. Confirm that the Web browser can be used beforehand.
Compatible OS : Windows XP/Windows Vista/Windows 7, Mac OS X v10.4/v10.5/v10.6/v10.7
Compatible Web Browser : Internet Explorer 7.0/8.0/9.0, Safari 4.0/5.0 (Mac OS)
- Communication with an E-mail server is required to use the E-mail function. Confirm that the E-mail can be used beforehand.
- Use shielded LAN cable (STP cable) that is compatible with category 5 or above.
- Use a LAN cable with length of 100 m or shorter.

Twisted pair cable Extender connections

This projector is able to receive image and video signal from Twisted pair cable Extender via LAN cable.

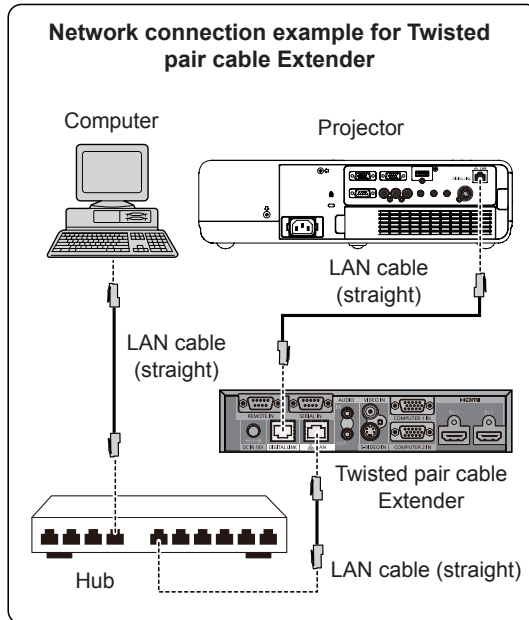

Notes on Twisted pair cable Extender connections

- Request the specialized technician or your dealer for wiring work of the cable for DIGITAL LINK. If the work is not properly conducted, the cable transmission characteristics do not meet, and the images and sounds may be interrupted or become unstable.
- For the LAN cable between the Twisted pair cable Extender and the projector, use the cable that conforms with the following conditions.
 - Compatible to the CAT5e or a higher standard
 - Shield type (including the connector)
 - Straight wire connection
 - Single wire
- The maximum transferable distance is 100 m (328'11") between the Twisted pair cable Extender and the projector. When the distance is longer than this maximum distance, the image or the sound may be interrupted, or erroneous performance occurs in LAN.
- When installing the cable, confirm that the cable specification satisfies the characteristics of CAT5e or higher by using a cable tester or a cable analyzer. When a relay connector is used in the middle, measure in a condition that the relay-connector is included.
- Do not use the switching hub between the Twisted pair cable Extender and the projector.
- When connecting to the projector using the Twisted pair cable Extender (receiver) of other maker, do not use another Twisted pair cable Extender between the Twisted pair cable Extender of other maker and the projector. The images and sounds may be interrupted or become unstable.
- Do not pull the cable with a strong force. In addition, do not bend or fold forcibly.
- The projector becomes easier to get affected by the internal noise, as well as the external noise. Therefore, install and use the cable without being wound as much as possible.
- Do not bind the cables between the Twisted pair cable Extender and the projector with other cables, especially the power cable. Keep the distance from other parallelly set cables as far as possible.
- When connecting multiple cables, shorten the parallelly passing distance as short as possible.
- Confirm that the signal quality is -12 dB or lower in [DIGITAL LINK status] after connecting the cable.
- For twisted-pair-cable transmitter of other manufacturers of which the operation has been verified with the DIGITAL LINK compatible projector, refer to Panasonic website (<http://panasonic.net/avc/projector/>). Note that the verification for devices of other manufacturers has been made for the items set by Panasonic Corporation, and not all the operations have been verified. For operation or performance problems caused by the devices of other manufacturers, contact the respective manufacturers.

Computer operation

Connection can be made with wired LAN. However, confirm to your system administrator on network settings before changing any settings.

- 1) Turn on the computer.
- 2) Make the network setting according to your system administrator.

If the projector settings are the default settings (➔page 63), the computer can be used with the following network settings.

DHCP	Off
IP address	192.168.10.101
Subnet mask	255.255.255.0
Default gateway	192.168.10.1
DNS1/DNS2	NONE

Accessing from the Web browser

- 1) Activate the Web browser in the personal computer.
- 2) Enter the IP address set by the projector into the URL input field of the Web browser.
- 3) Enter your “User name” and “Password”.
 - The factory default settings are user1 (user privileges) or admin1 (administrator privileges) for the user name and panasonic (lowercase letters) for the password.
- 4) Click [OK] to display the Projector status page.
 - “Projector status” page is displayed.

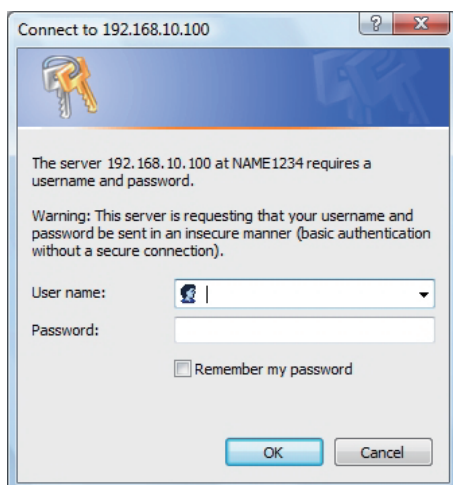

Note

- Avoid activating two or more Web browser simultaneously to work out setting or control actions.
- Change the password first of all.
- Administrator privileges enable the use of all functions. User privileges enable the use of only “Projector status”, “Network status”, “Basic control”, “Advanced control” and “Change password”.
- If you want to control the projector using a Web browser, set [Network control] in the network menu to [On].
- There are some control items used with the JavaScript function in the setting pages. If the web browser is set not to use this JavaScript function, it may not control the projector properly.

Description of each item



- 1 Page selection tabs
Click these to switch pages.
- 2 Monitor information button
Click this item, and the status of the projector is displayed.
- 3 Projector control button
Click this item to display the projector control page.
- 4 Detailed set up button
Click this item to display the advanced settings page.
- 5 Change password button
Click this button to display the password change page.
- 6 CRESTRON RoomView button
Click this button to monitor and control the projector through the CRESTRON Roomview.
- 7 Language switch button
Click this button to switch language between English and Japanese.

Projector status page

Click [Status], then [Projector status] to display the Status information page.
This page displays the projector statuses established for the items shown below.

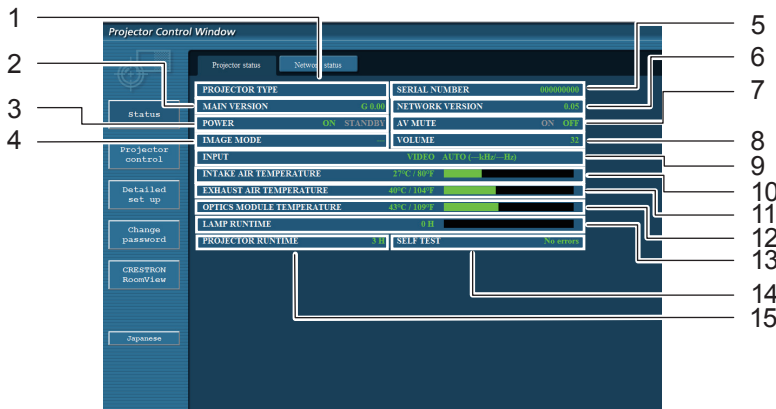

- 1 Displays the type of projector.
- 2 Displays the firmware version of the projector main unit.
- 3 Displays the power source status.
- 4 Displays the video mode status.
- 5 Displays the serial number of the projector.
- 6 Displays the firmware version of the network.
- 7 Displays the AV mute status.
- 8 Displays the volume status.
- 9 Displays the status of input switch.
- 10 Displays the intake temperature status of the projector.
- 11 Displays the exhaust temperature status of the projector.
- 12 Displays the optics module temperature status of the projector.
- 13 Displays the use time of the lamp.
- 14 Displays the self diagnostics information.
(▶ page 69)
- 15 Displays the runtime of the projector.

Error information page

If [Error (Detail)] is displayed in the self-diagnosis information display column on the [Projector status] screen, click the part to display the details of the error.

- Depending on the nature of the error, the projector may be placed in the standby mode for its own protection.

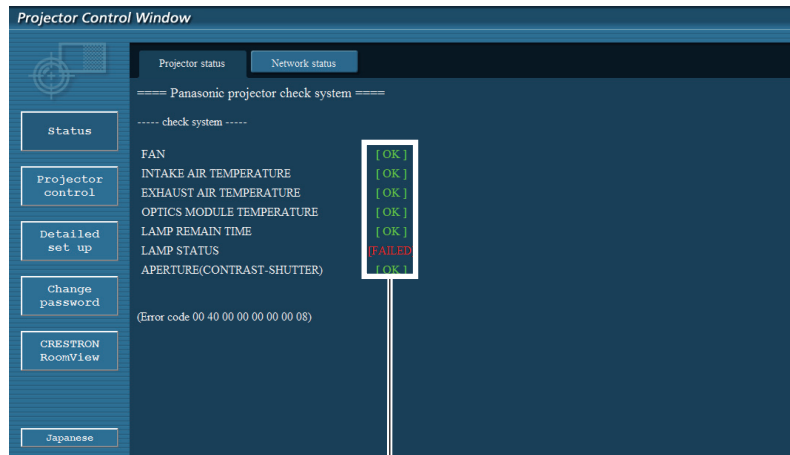

OK: Normal operation
 FAILED: Occurrence of trouble
 WARNING: Abnormal condition

When [FAILED] has appeared for an item

Parameter	Description
FAN	Trouble has occurred in the fan or its drive circuit. Consult your dealer.
INTAKE AIR TEMPERATURE	Intake air temperature is high. It could be because it is used in an environment of high temperature such as close to a heating device, etc., the air intake is blocked, or the air filter is clogged.
EXHAUST AIR TEMPERATURE	Exhaust air temperature is high. Exhaust may be blocked, or [Fan control] mode may be set wrong. (➔page 58)
OPTICS MODULE TEMPERATURE	Optics module temperature is high.
LAMP REMAIN TIME	The lamp runtime has exceeded the prescribed cumulative time, and it is now time to replace the lamp.
LAMP STATUS	The lamp has failed to light. Wait a short while for the lamp to cool off, and then turn on the power.
APERTURE (CONTRAST-SHUTTER)	Trouble has occurred in the contrast shutter circuitry. Consult your dealer.

Network status page

Displays the current configuration information of the network.

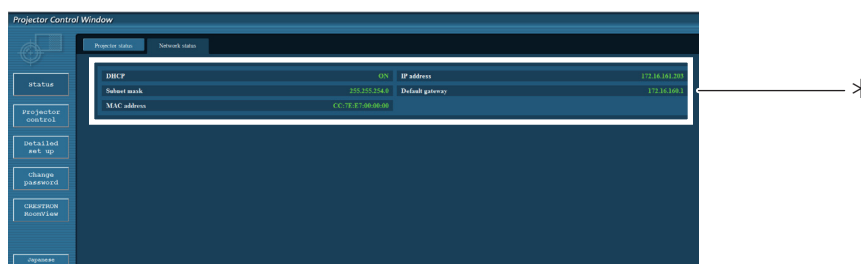

*Displays the configuration details of wired LAN.

Network

Basic control page

To move from another page, click [Projector control], then [Basic control].

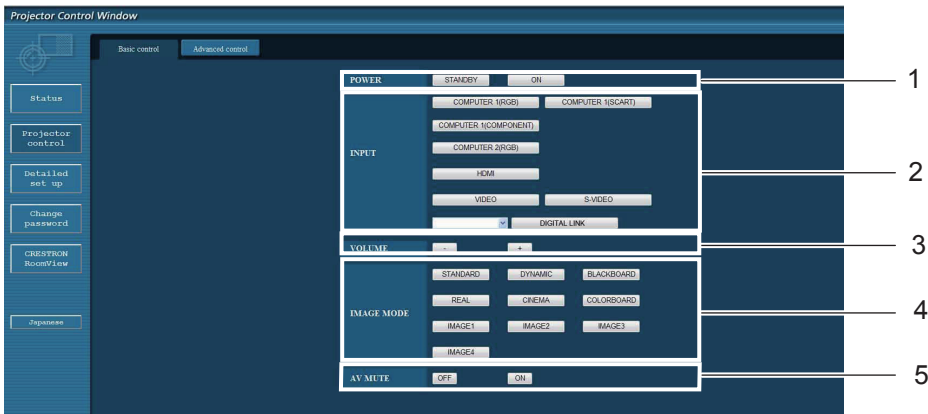

- 1 Power standby/on control
- 2 Use these to select the input signals
- 3 Volume adjust
- 4 Switches image mode
- 5 Operation of AV mute

Detail control page

Click [Projector control], then [Advanced control] to display the Detail control page.



- 1 Execute Auto setup function
- 2 Operations on Screen mode
- 3 Operations on Keystone function
- 4 Operations on Rear/Ceiling
- 5 Operations on Image adjust

Network config page

You can change network settings on projector when connecting with the administrator authority.

LAN settings

- 1) Click [Detailed set up] in the menu.
- 2) Click [Change] to change the LAN settings.
 - To return to the previous window, click [Back].
- 3) Complete the detailed settings and click [Next].
 - When [Next] is clicked, the next page appears, enabling you to complete the detailed settings as desired. Settings performed here are the same as the settings performed with the [Network] menu of the projector.
- 4) Click [Submit].
 - The settings will be registered.

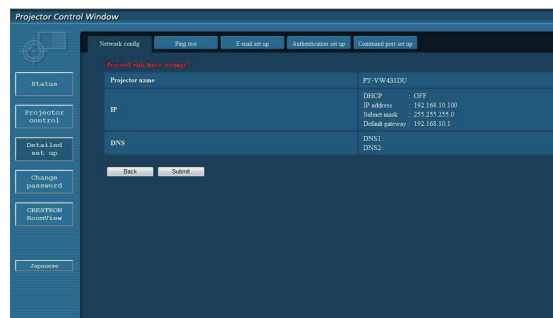
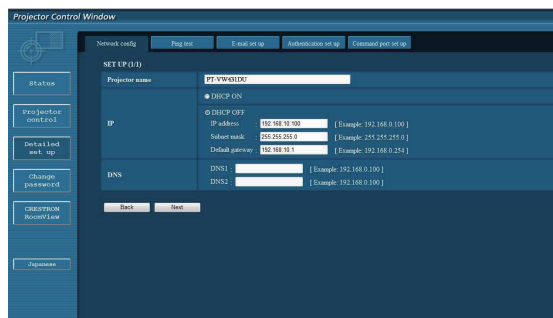
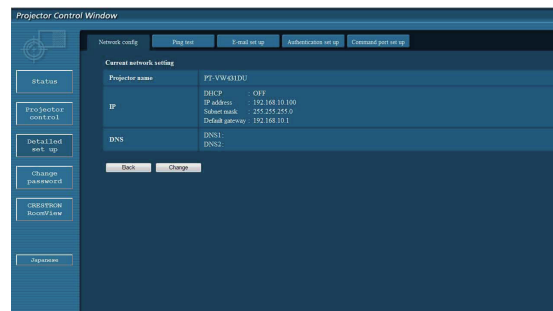

Note

- Changing the setting of LAN while connected with LAN might disconnect the connection.

Ping test page

This page makes it possible to check whether the network is connected to the e-mail server, POP server, DNS server, etc.

Click [Detailed set up], then [Ping test] to display the Ping test page.

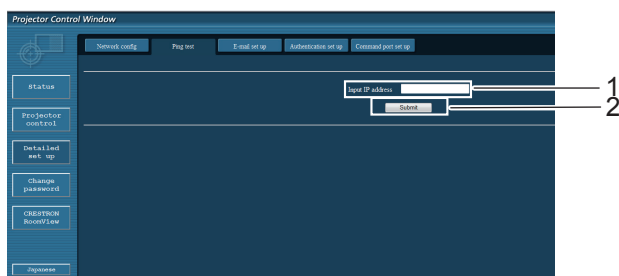

- 1 Enter the IP address of the server to be tested.
- 2 Button for conducting the test.

Display which appears when the connection was successful.

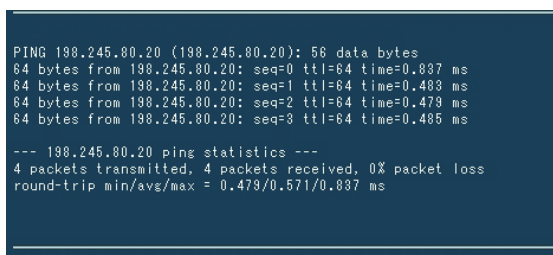

Display which appears when the connection failed.

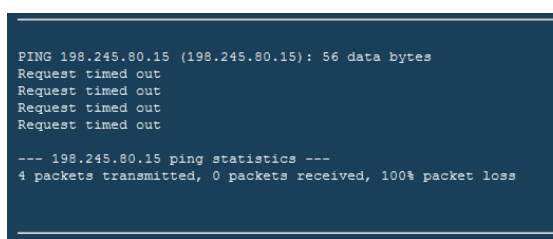

E-mail set up page

With this projector, if a problem occurs or if the lamp usage time reaches a set value, an e-mail message can be sent to one or more preset e-mail addresses (maximum two addresses). Click [Detailed set up], then [E-mail set up] to display the E-mail setup page.

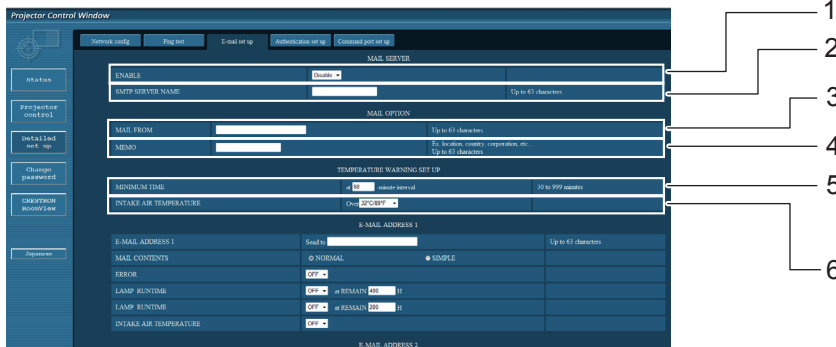

- 1 Select Enable to use the e-mail function.
- 2 Enter the IP address or server name of the e-mail server (SMTP). The DNS server must be set if the server name is entered.
- 3 Enter the e-mail address of the projector. (maximum 63 characters)
- 4 The user can enter the location of, for example, the installed projector so that the recipient may easily identify the originator of the e-mail. (maximum 63 characters)
- 5 The user can modify the minimum time interval of temperature warning mail. The default value is 60 minutes. In this case, the user cannot send another mail for 60 minutes after sending previous temperature warning mail even the set warning temperature is reached again.
- 6 Select the temperature of the intake sensor at which to send a warning message.

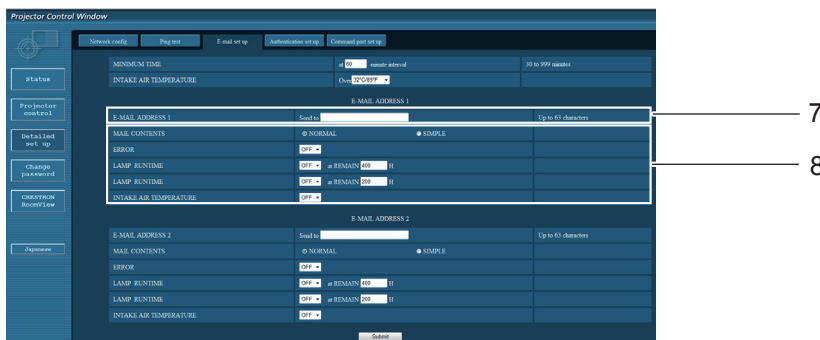

- 7 Enter the E-mail Address1 of your desired recipient.
- 8 Select the conditions for sending e-mail.

- MAIL CONTENTS:** Select [NORMAL] or [SIMPLE].
- ERROR:** An error is detected by self-diagnosis.
- LAMP RUNTIME:** Remaining lamp service time has reached the value set in the field.
- INTAKE AIR TEMPERATURE:** Intake air temperature has reached the value set in the field.

E-mail set up page (continued)

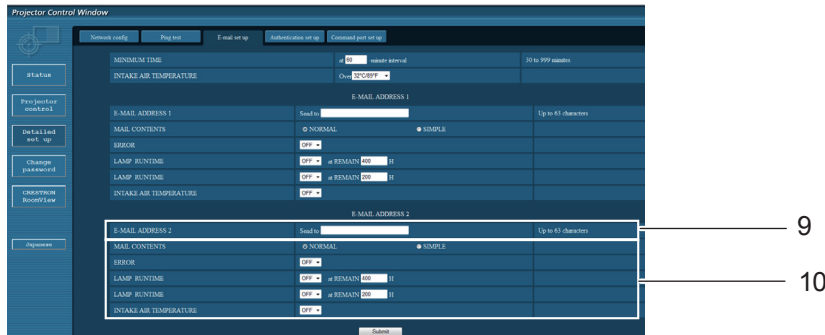

9 Enter the E-mail Address2 of your desired recipient.

10 Select the conditions for sending e-mail.

- MAIL CONTENTS:** Select [NORMAL] or [SIMPLE].
- ERROR:** An error is detected by self-diagnosis.
- LAMP RUNTIME:** Remaining lamp service time has reached the value set in the field.
- INTAKE AIR TEMPERATURE:** Intake air temperature has reached the value set in the field.

Authentication set up page

The POP/SMTP server is set on this page when POP/SMTP authentication is required for mail transmissions. Click [Detailed set up], then [Authentication set up] to display the Authentication server setup page.

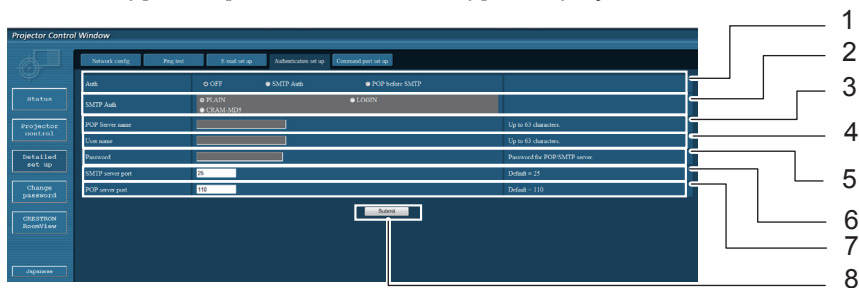

- 1 Select the authentication method specified by your Internet service provider.
- 2 Set this if SMTP authentication has been selected.
- 3 Enter the IP address or server name of the POP server. The DNS server must be set if the server name is entered:
Alphanumeric characters (A - Z, a - z, 0 - 9), hyphen (-), period (.)
- 4 POP/SMTP server user name field
- 5 POP/SMTP server password field
- 6 Enter the port number for the SMTP server (normally "25").
- 7 Enter the port number for the POP server (normally "110").
- 8 Button to update settings

■ Contents of mail sent

- Mail with the contents shown below is sent when the e-mail settings have been established.

```
=== Panasonic projector report(CONFIGURE) ===
Projector Type      : PT-VW431DU
Serial No          : 000000000
----- E-mail setup data -----
TEMPERATURE WARNING SETUP
MINIMUM TIME       at [ 60] minutes interval
INTAKE AIR TEMPERATURE Over [ 32degC / 89degF ]

ERROR              [ OFF ]
LAMP RUNTIME       [ OFF ]   at REMAIN [ 400] H
LAMP RUNTIME       [ OFF ]   at REMAIN [ 200] H
INTAKE AIR TEMPERATURE [ OFF ]

----- check system -----
FAN                [ OK ]
INTAKE AIR TEMPERATURE [ OK ]
EXHAUST AIR TEMPERATURE [ OK ]
OPTICS MODULE TEMPERATURE [ OK ]
LAMP REMAIN TIME    [ OK ]
LAMP STATUS         [ OK ]
APERTURE (CONTRAST-SHUTTER) [ OK ]

(Error code 00 00 00 00 00 00 00 00)

Intake air temperature  :[ 31 degC / 87 degF ]
Exhaust air temperature  :[ 37 degC / 98 degF ]
Optics module temperature :[ 39 degC / 102 degF ]

PROJECTOR RUNTIME      1 H

LAMP ECO              500 H
LAMP NORMAL           300 H
LAMP REMAIN           2400 H

----- Current status -----
MAIN VERSION          1.00
NETWORK VERSION       1.00
LAMP STATUS           LAMP=ON
INPUT                 RGB
SIGNAL NAME           XGA6
SIGNAL FREQUENCY      0.00kHz / 0.00Hz

----- Wired Network configuration -----
DHCP Client          OFF
IP address           192.168.10.100
MAC address          04:20:9A:00:00:00

----- Memo -----
```

- Mail with the contents shown below is sent when an error has occurred.

```

=== Panasonic projector report(ERROR) ===
Projector Type       : PT-VW431DU
Serial No           : 000000000
----- check system -----
FAN                 [ OK ]
INTAKE AIR TEMPERATURE [ OK ]
EXHAUST AIR TEMPERATURE [ OK ]
OPTICS MODULE TEMPERATURE [ OK ]
LAMP REMAIN TIME     [ OK ]
LAMP STATUS          [ FAILED ]
APERTURE (CONTRAST-SHUTTER) [ OK ]

(Error code 00 40 00 00 00 00 00 08)

Intake air temperature  : [ 31 degC / 87 degF ]
Exhaust air temperature : [ 37 degC / 98 degF ]
Optics module temperature : [ 39 degC / 102 degF ]

PROJECTOR RUNTIME      1 H

LAMP ECO               500 H
LAMP NORMAL            300 H
LAMP REMAIN            2400 H

----- Current status -----
MAIN VERSION          1.00
NETWORK VERSION       1.00
LAMP STATUS           LAMP=OFF
INPUT                 NETWORK

----- Wired Network configuration -----
DHCP Client           OFF
IP address            192.168.10.100
MAC address           04:20:9A:00:00:00

----- Memo -----

```

■ Command port set up page

Set the port number to be used with command control.
Click [Detailed set up] → [Command port set up].

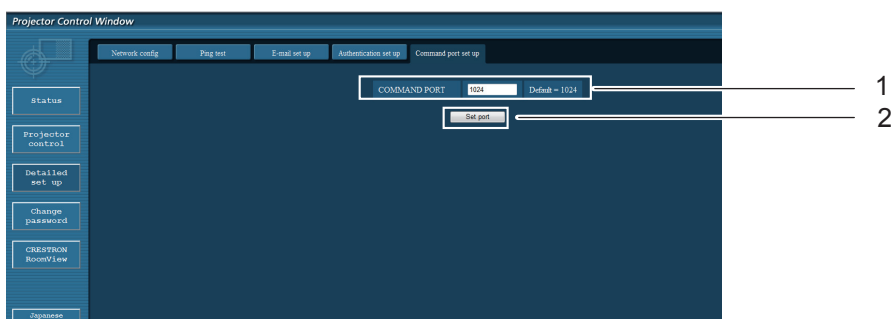

- 1 Input the port number to be used with command control
- 2 Setting update button

Change Password page

Click [Change password].

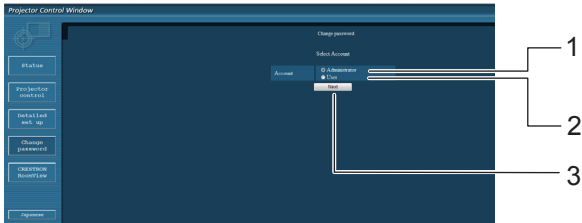

- 1 Used to change the setting of [Administrator].
- 2 Used to change the setting of [User].
- 3 Used to change the setting of the password.

Administrator account

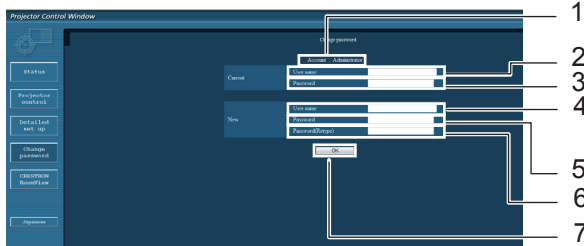

- 1 Displays the account to change
- 2 Current user name input field
- 3 Current password input field
- 4 New user name input field
- 5 New password input field
- 6 New password input field (re-enter for confirmation)
- 7 Button for executing password change

User account



- 1 Displays the account to change
- 2 New user name input field
- 3 New password input field
- 4 New password input field (re-enter for confirmation)
- 5 Button for executing password change

Change Password page (with the user rights)

Only the change of password is enabled under the user rights.

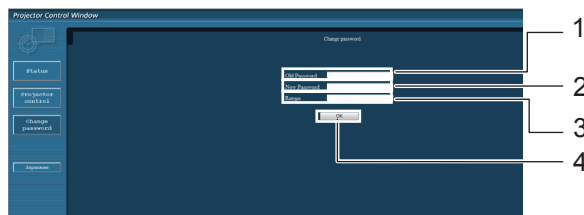

- 1 Current password input field
- 2 New password input field
- 3 New password input field (re-enter for confirmation)
- 4 Button for executing password change

Note

- When changing the administrator account, both “Current user name” and “Current password” are required.
- No account is not available.
- Administrator account and user account should be differed.

CRESTRON RoomView page

You can monitor or control the projector using RoomView.

To display the operation page of RoomView from Web Control screen, access with the administrator rights is required. (The [CRESTRON RoomView] button is not displayed on the Web Control screen when accessing with the user rights.)

When you click [CRESTRON RoomView], the RoomView operation page is displayed.

If Adobe Flash Player is not installed in your computer, or if the browser does not support Flash, this page does not appear. In this case, return to the previous page by clicking [Back] in the operation page.

Operation page

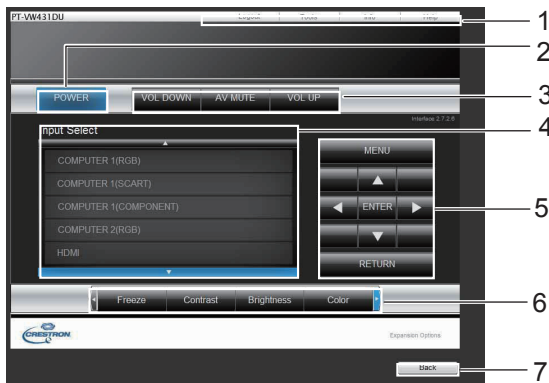

1 Logout, Tools, Info, Help

Exit the page when the password has changed and switches the pages for tools, information, help using the tab.

2 POWER

Switches between on and off of the power.

3 VOL DOWN, AV MUTE, VOL UP

Sets the volume, AV mute. When the power of the projector is turned off, VOL DOWN, AV MUTE and VOL UP are not available.

4 Input Select

Sets the input selection. When the power of the projector is turned off, this operation is not available.

5 Operation buttons on the menu screen

Operates on the menu screen.

6 Freeze, image quality adjustment

Sets freeze, image quality details.

7 Back

Returns to the previous page.

Tools page

Click Tools on the operation page.

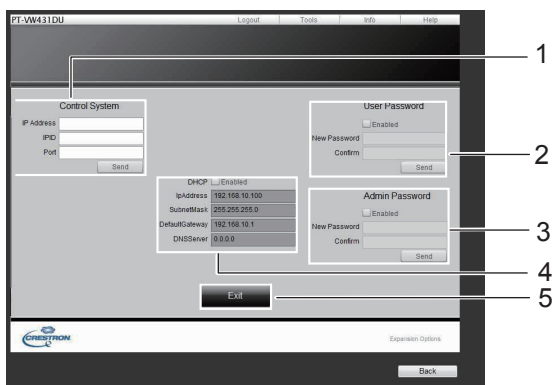

1 Control system

Sets the information required for the communication with the controller that is connected to the projector.

2 User Password

Sets the password for the user rights in the operation page of RoomView.

3 Admin Password

Sets the password for the administrator rights in the operation page of RoomView.

4 Network status

Displays the setting of wired LAN.

DHCP: Displays the value in the current setting.

IpAddress: Displays the value in the current setting.

SubnetMask: Displays the value in the current setting.

DefaultGateway: Displays the value in the current setting.

DNSServer: Displays the value in the current setting.

5 Exit

Return to the operation page.

Note

- When you monitor or control the projector using RoomView, set [RoomView] to [On] in the [Network] menu. (◆page 64)

Network

Info page

Click Info on the operation page.

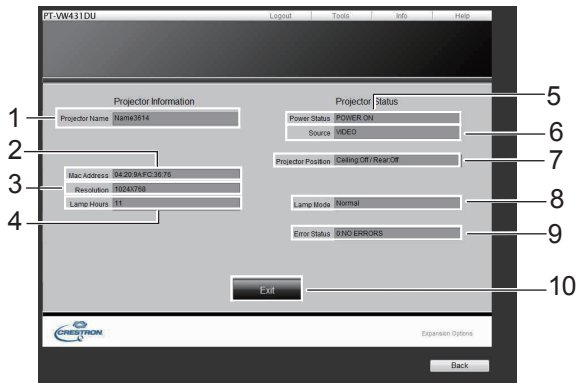

- 1 Projector name**
Displays the name of the projector.
- 2 Mac Address**
Displays the MAC address.
- 3 Resolution**
Displays the resolution of the projector.
- 4 Lamp Hours**
Displays the lamp usage time (converted value).
- 5 Power Status**
Displays the status of the power.
- 6 Source**
Displays the selected video input.
- 7 Projector Position**
Displays the projection method of the projector.
- 8 Lamp Mode**
Displays the lamp mode.
- 9 Error Status**
Displays the error status.
- 10 Exit**
Return the operation page.

Help page

Click Help on the operation page.
The Help Desk screen is displayed.

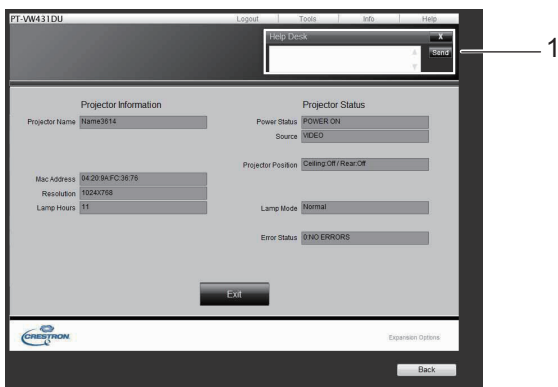

- 1 Help Desk**
Sends or receive messages to the administrator who uses Crestron RoomView.

LAMP and WARNING Indicators

Managing the indicated problems

If a problem should occur inside the projector, the <ON(G)/STANDBY(R)>, <LAMP> and/or <WARNING> indicators will inform you. Manage the indicated problems as follow.

CAUTION

- Before you take a remedial measure, follow the procedure of switching the power off indicated in “Turning off the projector”. (➔page 31)
- If multiple indicators light or blink, verify the status of the projector by looking at each indicator.

Note

- Confirm the status of the power indicated on the <ON(G)/STANDBY(R)> indicator.

■ LAMP indicator

Indicator	Lighting in yellow
Status	The projection lamp reaches its end of life.
Check	Is there a Lamp replacement icon appears on the screen?
Remedy	Replace the lamp unit. (➔page 83)

Note

- Contact your dealer for repair services when <LAMP> indicator persists to light after taking these measurements.

■ WARNING indicator

Indicator	Lights in red.	Blinks in red.
Status	The projector detects an abnormal condition and cannot be turned on.	If the temperature within the projector becomes too high, the <WARNING> indicator will start to flash slowly. If the temperature within the projector becomes even higher, the <WARNING> indicator will flash faster, and the <ON(G)/STANDBY(R)> indicator blinks in orange. When the projector has cooled inside and returned to operating temperature, it will turn off automatically.
Check	Unplug the AC power cord and plug it again to turn on the projector.	- Did you provide appropriate space for the projector to be ventilated? Check the installing condition to see if the air vents of the projector are not blocked. - Has the projector been installed near an Air-Conditioning/ Heating Duct or Vent? - Are the filters clean?
Remedy	If the projector is turned off again, unplug the AC power cord and contact the dealer or the service center for service and checkup.	- Provide good installing condition to your projector. - Move the installation of the projector away from the duct or vent. - Replace filters.

Note

- If <WARNING> indicator persists to light or blink after taking these measurements, please contact your dealer for repair services. Do not leave the projector on. It may cause an electric shock or a fire hazard.
- The projector detects an abnormal condition and cannot be turned on. Unplug the AC power cord and plug it again to turn on the projector. If the projector is turned off again, unplug the AC power cord and contact the dealer or the service center for service and checkup. Do not leave the projector on. It may cause an electric shock or a fire hazard.

Replacement

Before replacing the unit

- When you perform maintenance or replacement of the parts, make sure to turn off the power and disconnect the power plug from the wall outlet. (► pages 27, 31)
- Be sure to observe the procedure “Turning off the projector” (► page 31) when performing power supply operation.

Maintenance

Outer Case

Wipe off dirt and dust using a soft dry cloth.

- If the dirt is persistent, soak the cloth with water and wring it thoroughly before wiping. Dry off the projector with a dry cloth.
- Do not use benzene, thinner, or rubbing alcohol, other solvents, household cleaners. Using them may cause deterioration of the outer case.
- When using chemical treated dusters, follow its instruction.

Front glass surface of the lens

Wipe off the dirt and dust off the front surface of the lens with soft clean cloth.

- Do not use a cloth that has an abrasive surface or a cloth that is moist, oily, or covered with dust.
- Do not use excessive force when wiping the lens as it is fragile.

Attention

- The lens is made of glass. Impacts or excessive force when wiping may scratch its surface. Please handle with care.

Replacing the unit

Air filter units

Filter prevents dust from accumulating on the optical elements inside the projector. Should the filter become clogged with dust particles, it will reduce cooling fans' effectiveness and may result in internal heat buildup and adversely affect the life of the projector.

If the air filter units become clogged, it will result in internal heat buildup, the power of the projector may be turned off for safety.

If a “Filter warning” icon  appears on the screen, replace the filters immediately. Consult your dealer to purchase a replacement air filter unit (ET-RFV200).

The air filter units are provided in side and back of the projector.

■ Replacement of the air filter unit (side)

1) Remove the air filter cover.

- Open the air filter cover in the direction of the arrow in the figure and remove it.

2) Remove the air filter unit.

- Hold the knob of the air filter unit and pull out in the direction of the arrow, the top of the air filter unit will pop up.
 - Take out the air filter unit upwards.
- After removing the air filter unit, remove large foreign objects and dust from the air filter compartment and the projector's air intake port if there are any.

3) Insert the new air filter unit.

- Hold the air filter unit that the knob is outside of the projector, perform Step 2) in the reverse order.
- Do not press the filter part when push into the projector at last.

4) Install the air filter cover.

- Make sure that the air filter cover is closed tightly.

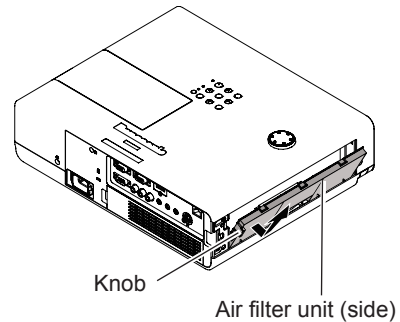
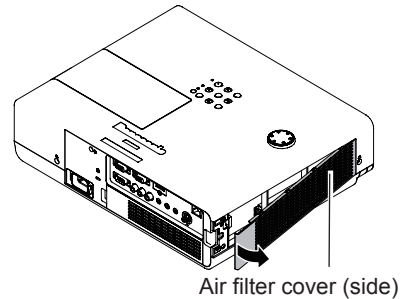

■ Replacement of the air filter unit (back)

1) Remove the air filter cover.

- Open the air filter cover in the direction of the arrow in the figure and remove it.

2) Remove the air filter unit.

- Hold the knob of the air filter unit and pull out in the direction of the arrow.
- After removing the air filter unit, remove large foreign objects and dust from the air filter compartment and the projector's air intake port if there are any.

3) Insert the new air filter unit.

- Hold the air filter unit that the knob is outside of the projector, perform Step 2) in the reverse order.
- Do not press the filter part when push into the projector at last.

4) Install the air filter cover.

- Make sure that the air filter cover is closed tightly.

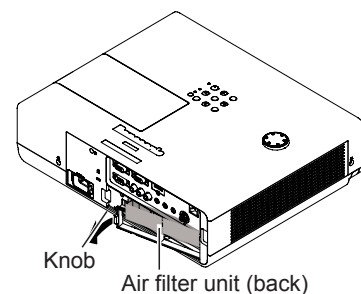
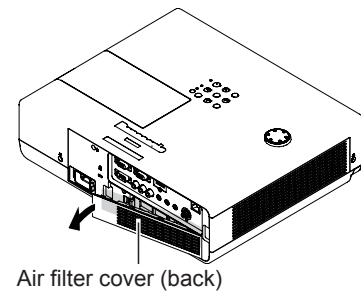

■ Resetting the Filter Counter

Be sure to reset the Filter counter after replacing the filter. (➔page 59 "Filter counter reset")

Attention

- Turn off the power before you replace the air filter units.
- When attaching the air filter unit, make sure that the projector is stable, and work in an environment that is safe, even in the event of the air filter unit dropping.
- Do not operate the projector with the air filter units removed. Dust may accumulate on the optical elements degrading picture quality.
- Do not put anything into the air vents. Doing so may result in malfunction of the projector.
- The air filter unit to be replaced should be an unused product.
- After replacing the air filter, reset the filter counter. Otherwise, the power of the projector may be turned off for safety.

Replacement

Lamp unit

The lamp unit is a consumable component. You can check the total usage time using Lamp runtime in the Information menu (➔page 61).

It is recommended to ask an authorized engineer to replace the lamp unit. Contact your dealer. Consult your dealer to purchase a replacement lamp unit (ET-LAV200).

CAUTION:

- **Do not replace the lamp unit when it is hot. (Wait at least 1 hour after use.)**

The inside of the cover can become very hot, take care to avoid burn injuries.

Notes on the replacement of the lamp unit

- The luminous source of the lamp is made of glass and may burst if you hit it against a hard surface or drop it. Please handle with care.
- A Phillips screwdriver is required for replacement of the lamp unit.
- When replacing the lamp unit, be sure to hold it by the handle.
- When replacing the lamp because it has stopped illuminating, there is a possibility that the lamp may be broken. If replacing the lamp of a projector which has been installed on the ceiling, you should always assume that the lamp is broken, and you should stand to the side of the lamp cover, not underneath it. Remove the lamp cover gently. Small pieces of glass may fall out when the lamp cover is opened. If pieces of glass get into your eyes or mouth, seek medical advice immediately.
- The lamp contains mercury. Consult your local municipality or your dealer about correct disposal of used lamp units.

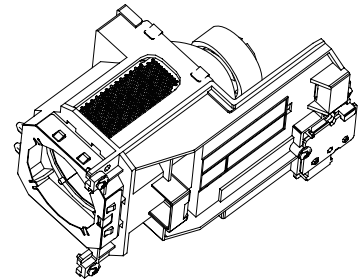



Attention

- Do not use other than designated lamp units.
- The part numbers of accessories and separately sold components are subject to change without notice.

When to replace the lamp unit

The lamp unit is a consumable component. Brightness decreases according to duration of usage, so periodical replacement of the lamp unit is necessary.

When the projection lamp of the projector reaches its end of life, the Lamp replacement icon appears on the screen and <LAMP> indicator lights yellow. Replace the lamp with a new one promptly.

Lamp runtime	On screen Lamp replacement icon 	LAMP indicator 
Over 2 500 hours *	The message is displayed for 4 seconds. If you press any button within the 4 seconds, the message disappears.	Lights in yellow (even in stand-by mode).
Over 2 700 hours *	If the power is turned on without replacing the lamp, the power automatically turns off after approximately ten minutes to prevent the malfunction of the projector.	

*2 700 hours of use is a rough guideline, but is not a guarantee. The lamp runtime differs depending on the setting of "Lamp power" menu.

Note

- The Lamp replacement icon will not appear when the Display function is set to [Off] (➔page 54), or during "Freeze" (➔page 34), or "AV mute" (➔page 35).

■ Replacing the Lamp unit

CAUTION:

- When the projector is mounted on a ceiling, do not work with your face close to the projector.
- Attach the lamp unit and the lamp cover securely.
- When you experience difficulty in installing the lamp, remove it and try again. If you use force to install the lamp, the connector may be damaged.
- Do not use other than designated lamp units.
- Do not loosen other than designated screws.

1) Turn off the Power and unplug the AC power cord. Wait at least 1 hour and make sure the lamp unit and surroundings are cool.

2) Use a Phillips screwdriver to loosen the lamp cover fixing screw and remove the lamp cover.

- Remove the lamp cover by pulling it slowly toward the direction of the arrow.

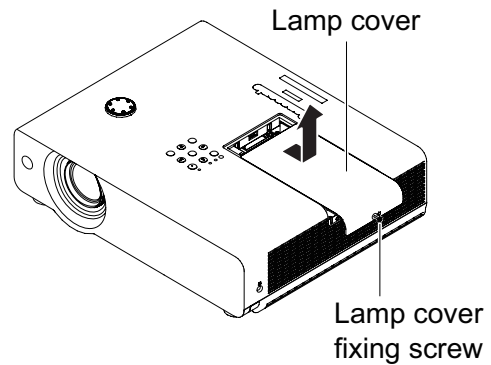

3) Use a Phillips screwdriver to loosen the three lamp unit fixing screws until the screws turn freely. Hold the used lamp unit by its handles, and pull it gently from the projector.

4) Insert the new lamp unit in correct direction. Tighten the three lamp unit fixing screws securely with a Phillips screwdriver.

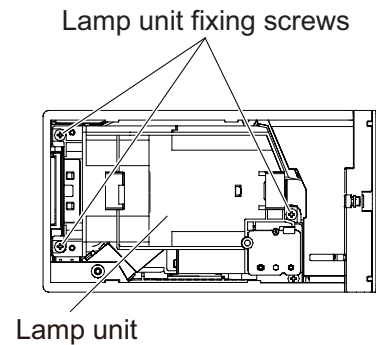

5) Attach the lamp cover, and tighten the lamp cover fixing screw securely with a Phillips screwdriver.

- Attach the lamp cover by pushing it slowly opposite the direction of the arrow.

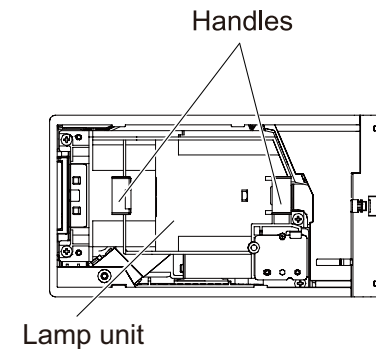

Note

- When you replace the new lamp unit (ET-LAV200), the projector resets the total usage time of the lamp unit automatically.

Replacement

Attaching the Lens Cap

When moving this projector or while not using it over an extended period of time, attach the lens cap. To prevent loss for the lens cap, please according to the following procedures, attach the lens cap with the string of accessories.

- 1) Thread the thinner end of the string through the hole on the lens cap.

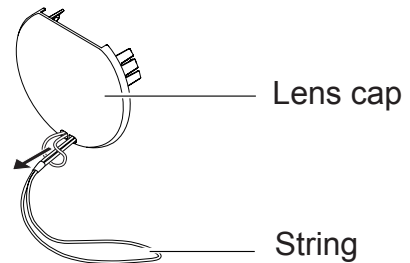

- 2) Thread the other end of the string through the hole on the bottom of the projector.

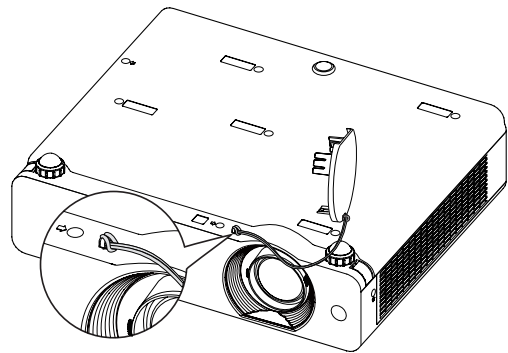



Troubleshooting

Please check following points. For details, see the corresponding pages.

Problem	Cause	Reference page
Power does not turn on.	● The power cord may not be connected.	—
	● No electric supply is at the wall outlet.	—
	● The circuit breakers have tripped.	—
	● Is the <LAMP> indicator, <ON(G)/STANDBY(R)> indicator, or <WARNING > indicator lit or blinking?	28, 79
	● The lamp cover has not been securely installed.	83
No picture appears.	● The video signal input source may not be connected to a terminal properly.	26
	● The input selection setting may not be correct.	33
	● The [Brightness] adjustment setting may be at the minimum setting.	46
	● The input source which is connected to the projector may have a problem.	—
	● The AV mute function may be in use.	35
The picture is fuzzy.	● The lens focus may not have been set correctly.	32
	● The projector may not be at the correct distance from the screen.	23
	● The lens may be dirty.	14
	● The projector may be tilted too much.	—
	● The lens cap is still attached to the lens.	15
The color is pale or grayish.	● [Color] or [Tint] adjustment may be incorrect.	46
	● The input source which is connected to the projector may not be adjusted correctly.	—
	● RGB cable is damaged.	—
No sound from the internal speaker	● The input terminals may not have been correctly connected.	26
	● The volume may have been set to the minimum level.	35, 52
	● The AV mute function may have been turned on.	35
	● When the VARIABLE AUDIO OUT is plugged-in, the projector's built-in speaker is not available.	20
	● The Mute function may have been turned on.	36, 52
The remote control does not operate.	● The batteries may be weak.	—
	● The batteries may not have been inserted correctly.	21
	● The remote control signal receptor on the projector may be obstructed.	17
	● The remote control unit may be out of the operation range.	17
	● Strong light such as fluorescent shine onto the signal receptor.	17
	● When different codes are set on the projector and on the remote control.	57
The control buttons of the projector do not operate.	● The control panel is not available if the control panel is locked at [Key lock] under [Security] of [Setting] section.	57
The picture does not display correctly.	● There may be a problem with the VCR or other signal source.	—
	● A signal which is not compatible with the projector is being input.	94-97

Troubleshooting

Problem	Cause	Reference page
Picture from a computer does not appear.	<ul style="list-style-type: none"> The cable may be longer than the optional cable. The external video output from a laptop computer may not be correct. 	— —
Picture from a HDMI device does not appear or picture is not stable.	<ul style="list-style-type: none"> Is the HDMI cable securely connected? Turn off the power of the projector and the connected devices. Then turn the power of the projector and the connected devices back on. Isn't unsupported signal cable connected? 	26 — 94-97
No sound is output from a HDMI device.	<ul style="list-style-type: none"> Set the sound channel of the attached device to Linear PCM. If no audio signal is output during HDMI cable connection, connect the audio cable to COMPUTER AUDIO IN 2 terminal and set to "Computer 2" in "Sound" of "Setting" menu. 	— 55
The image is distorted or runs off.	<ul style="list-style-type: none"> Check [PC adj.] or [Screen] and adjust them. 	43, 49
The exclamation mark  appears on the screen.	<ul style="list-style-type: none"> Your operation is invalid. Operate correctly. 	—
No picture or sound is output from DIGITAL LINK input.	<ul style="list-style-type: none"> Is the cables securely connected between the Twisted pair cable Extender and the image (output) devices or between the Twisted pair cable Extender and the projector? Connect correctly. Confirm the [DIGITAL LINK mode] is set to [Auto] or [DIGITAL LINK] other than [Ethernet]. 	— 62
 [Service] appears in the top left of the screen.	<ul style="list-style-type: none"> Detected abnormal state inside the projector. Unplug the power cord and contact your dealer for maintenance. Be sure to unplug the power cord, or it may cause electric shock or fire. 	—

Note

- If the problem persists, after confirming the contents of the table, please consult your dealer.

Technical Information

PJLink protocol

The network function of the projector supports PJLink class 1, and the PJLink protocol can be used to perform projector setting and projector status query operations from a computer.

Control commands

The following table lists the PJLink protocol commands that can be used to control the projector.

Command	Control details	Notes
POWR	Power supply control	Parameters 0 = Standby 1 = Power ON
POWR ?	Power supply status query	Parameters 0 = Standby 1 = Power ON 2 = Cool-down in progress 3 = Warm-up in progress
INPT	Input selection	Parameters
INPT ?	Input selection query	11 = RGB 1 12 = RGB 2 13 = SCART 21 = VIDEO 22 = S-VIDEO 23 = COMPONENT 31 = HDMI 32 = DIGITAL LINK
AVMT	AV MUTE control	Parameters
AVMT ?	AV MUTE status query	30 = AV MUTE mode off 31 = AV MUTE mode on
ERST ?	Error status query	Parameters 1st byte : Indicates fan errors, range 0 – 2 2nd byte : Indicates lamp errors, range 0 – 2 3rd byte : Indicates temperature errors, range 0 – 2 4th byte : Fixed at 0 5th byte : Indicates filter errors, range 0 – 2 6th byte : Indicates other errors, range 0 – 2 Definitions for each value from 0 to 2 are as follows. 0 = No error known 1 = Warning 2 = Error
LAMP ?	Lamp status query	Parameters 1st digits (1 – 5 digits) : Lamp cumulative operating time 2nd digit : 0 = Lamp off, 1 = Lamp on
INST ?	Input selection list query	The followings are returned as parameters. "11, 12, 13, 21, 22, 23, 31, 32"
NAME ?	Projector name query	The name set for [Projector name] in [Network] is returned.
INF1 ?	Manufacturer name query	"Panasonic" is returned.
INF2 ?	Model name query	Answer the model name with "VW431DU".
INF0 ?	Other information query	Information such as version number is returned.
CLSS ?	Class information query	"1" is returned.

PJLink security authorization

When using PJLink with security authorization, either of the password set for administrator privileges and the password set for user privileges with Web browser control can be used as the password for PJLink (➔ page 76). When using PJLink without security authorization, set use without the password for administrator privileges and the password for user privileges of Web browser control.

For specifications regarding PJLink, refer to the Japan Business Machine and Information System Industries Association website.

<http://pjlink.jbmia.or.jp/english/>

Control commands via LAN

■ When WEB Control administrator rights password is set (Protect mode)

● Connection method

- 1) Obtain the IP address and port number (Initial set value = 1 024) of the projector and make a request for connection to the projector.

Acquire the IP address from the menu screen of the projector, and the port number from the WEB control page.

IP address : Obtain from MAIN MENU → [Network] → [Network status]

Port No. : Acquire from the WEB control “Detailed set up” → “Command port set up” page

- 2) There is a response from the projector.

Response data

Data section	Blank	Mode	Blank	Random number section	Termination symbol
“NTCONTROL” (ASCII string)	‘ ’ 0x20	‘1’ 0x31	‘ ’ 0x20	“zzzzzzzz” (ASCII code hexadecimal number)	(CR) 0x0d
9 bytes	1 byte	1 byte	1 byte	8 bytes	1 byte

Mode : 1 = Protect mode

- 3) Generate a 32-byte hash value from the following data using MD5 algorithm.

“xxxxxx:yyyyy:zzzzzzzz”

xxxxxx : Administrator rights user name for WEB CONTROL (Default user name is “admin1”)

yyyyy : Password of above administrator rights user (Default password is “panasonic”)

zzzzzzzz : 8-byte random number obtained in Step 2

● Command transmission method

Transmit using the following command format.

Transmitted data

Header		Data section	Termination symbol
Hash value (See above <Connection method>)	‘0’ 0x30	‘0’ 0x30	Control command (ASCII string)
32 bytes	1 byte	1 byte	Undefined length
			(CR) 0x0d
			1 byte

Receive data

Header		Data section	Termination symbol
‘0’ 0x30	‘0’ 0x30	Control command (ASCII string)	(CR) 0x0d
1 byte	1 byte	Undefined length	1 byte

Error response

Error message	Termination symbol
“ERR1” “ERR2” “ERR3” “ERR4” “ERR5” “ERRA”	(CR) 0x0d
Undefined control command Out of parameter range Busy state or no-acceptable period Timeout or no-acceptable period Wrong data length Password mismatch	
4 bytes	1 byte

■ When WEB Control administrator rights password is not set (Non-protect mode)

● Connection method

- 1) Obtain the IP address and port number (Initial set value = 1 024) of the projector and make a request for connection to the projector.

Acquire the IP address from the menu screen of the projector, and the port number from the WEB control page.

IP address : Obtain from MAIN MENU → [Network] → [Network status]

Port No. : Acquire from the WEB control “Detailed set up” → “Command port set up” page

- 2) There is a response from the projector.

Response data

Data section	Blank	Mode	Termination symbol
“NTCONTROL” (ASCII string)	‘ ’ 0x20	‘0’ 0x30	(CR) 0x0d
9 bytes	1 byte	1 byte	1 byte

Mode : 0 = Non-protect mode

● Command transmission method

Transmit by the following command format.

Transmitted data

Header		Data section	Termination symbol
‘0’ 0x30	‘0’ 0x30	Control command (ASCII string)	(CR) 0x0d
1 byte	1 byte	Undefined length	1 byte

Receive data

Header		Data section	Termination symbol
‘0’ 0x30	‘0’ 0x30	Control command (ASCII string)	(CR) 0x0d
1 byte	1 byte	Undefined length	1 byte

Receive data

Error message	Termination symbol
“ERR1” Undefined control command	(CR) 0x0d
“ERR2” Out of parameter range	
“ERR3” Busy state or no-acceptable period	
“ERR4” Timeout or no-acceptable period	
“ERR5” Wrong data length	
“ERRA” Password mismatch	
4 bytes	1 byte

Technical Information

Serial terminal

The serial connector which is on the connector panel of the projector conforms to the RS-232C interface specification, so that the projector can be controlled by a personal computer which is connected to this connector.

■ Connection

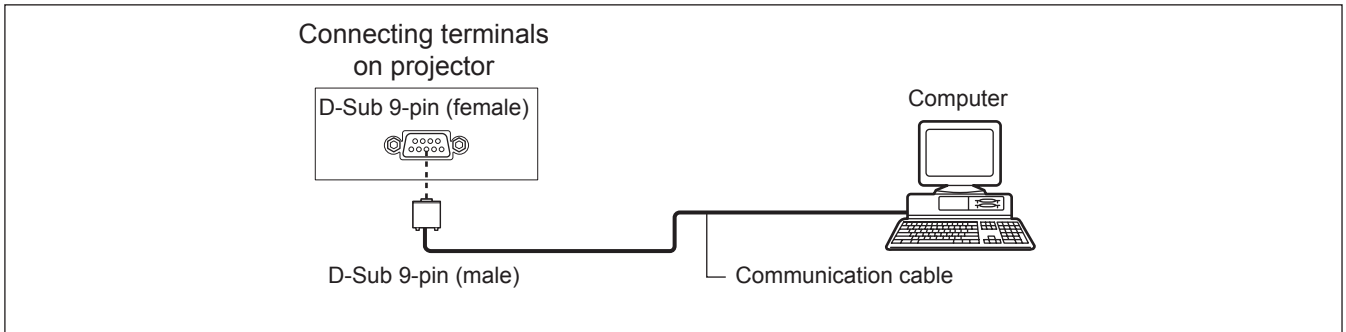

■ Pin assignments and signal names

D-Sub 9-pin (female) Outside view	Pin No.	Signal name	Contents
	①	—	NC
	②	TXD	Transmitted data
	③	RXD	Received data
	④	—	NC
	⑤	GND	Earth
	⑥	—	NC
	⑦	CTS	Connected internally
	⑧	RTS	
	⑨	—	NC

■ Communication conditions

Signal level	RS-232C-compliant
Sync. method	Asynchronous
Baud rate	9 600 bps
Parity	None

Character length	8 bits
Stop bit	1 bit
X parameter	None
S parameter	None

Note

- The serial control cannot be used when [RS232C] is set to [DIGITAL LINK].
- The Baud rate of PT-VW430 / PT-VX500 / PT-VW435N / PT-VX505N series and PT-VW431D series is different.

Basic format

Transmission from the computer begins with STX, then the command, parameter, and ETX are sent in this order. Add parameters according to the details of control.

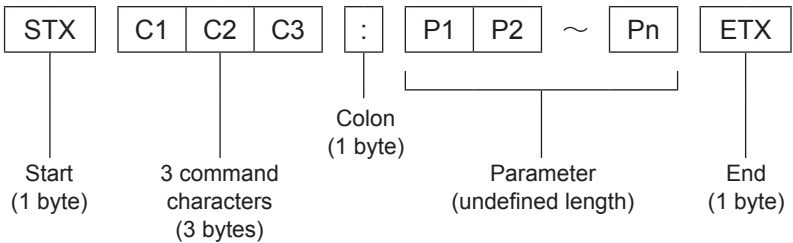

*: When sending commands without parameters, a colon (:) is not necessary.

Basic format (with sub command)

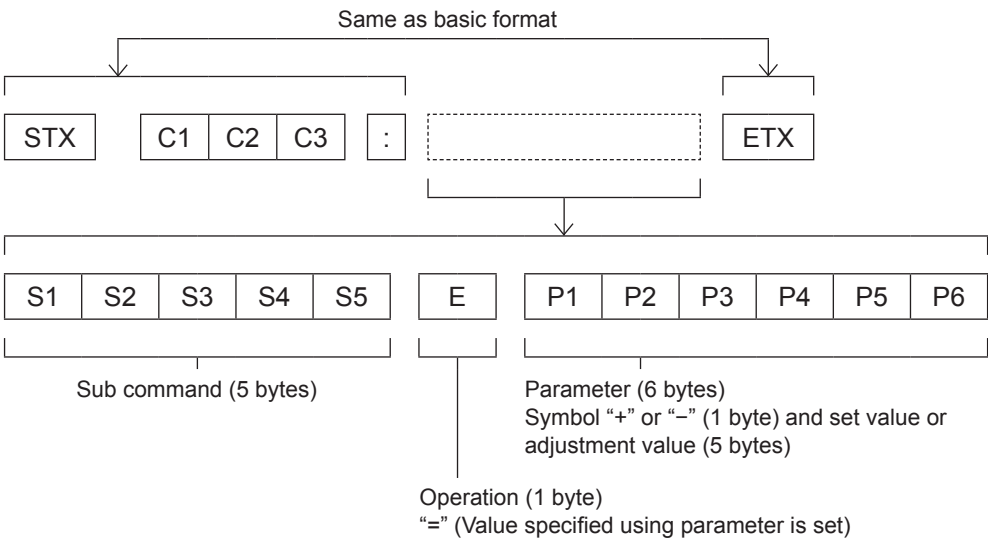

*: When transmitting a command which does not need a parameter, the operation (E) and parameter are not necessary.

Technical Information

■ Cable specifications

[When connected to a computer]

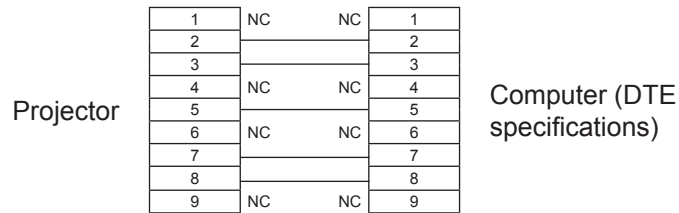

■ Control commands

When controlling the projector from a computer, the following commands are available:

[Projector control command]

Command	Control contents	Remarks
PON	Power [ON]	
POF	Power [OFF]	
IIS	INPUT selection	(Parameter) VID = Video SVD = S-video RG1 = Computer 1(RGB) RG2 = Computer 2(RGB) HD1 = HDMI SCT = Computer 1(Scart) DL1 = DIGITAL LINK
	When Digital interface box (Optional accessory: ET-YFB100G) is connected to <DIGITAL LINK> terminal, and INPUT is selected to DIGITAL LINK terminal and Digital interface box at the same time:	(Parameter) DL1:VID = Video DL1:SVD = S-video DL1:PC1 = Computer 1(RGB) DL1:PC2 = Computer 2(RGB) DL1:HD1 = HDMI 1 DL1:HD2 = HDMI 2
OSH	AV mute function	Turning off the projection and sound temporarily. Sending the command switches [ON]/[OFF]. Do not switch ON/OFF in a short period of time.
OFZ	Freeze	Sending the command switches [ON]/[OFF].
AUU	Volume up	
AUD	Volume down	
DZU	D. ZOOM up	
DZD	D. ZOOM down	
QPW	Power query	000 = Standby 001 = Power on
Q\$\$	Lamp condition query	(Call back) 0 = Stand-by 1 = Lamp ON control active 2 = Lamp ON 3 = Lamp OFF control active

Other terminals

Pin assignments and signal names of <S-VIDEO IN> terminal

Outside view	Pin No.	Signal names
	①	GND (luminance signal)
	②	GND (color signal)
	③	Luminance signal
	④	Color signal

Pin assignments and signal names of <COMPUTER 1 IN/COMPONENT IN> terminal

Outside view	Pin No.	Signal names
	①	R/P _R
	②	G/G · SYNC/Y
	③	B/P _B
	⑨	+ 5 V
	⑫	DDC data
	⑬	HD/SYNC
	⑭	VD
	⑮	DDC clock
	④	
	⑤ - ⑧, ⑩, ⑪	

④ : Not assigned
⑤ - ⑧, ⑩, ⑪ : GND terminals

Pin assignments and signal names of <COMPUTER 2 IN/MONITOR OUT> terminal

Outside view	Pin No.	Signal names
	①	R
	②	G
	③	B
	⑬	HD/SYNC
	⑭	VD
	④, ⑨, ⑪, ⑫, ⑮	
⑤ - ⑧, ⑩		

④, ⑨, ⑪, ⑫, ⑮ : Not assigned
⑤ - ⑧, ⑩ : GND terminals

Pin assignments and signal names of <HDMI IN> terminal

Outside view	Pin No.	Signal names	Pin No.	Signal names
<p>Even-numbered pins ② to ⑮</p> <p>Odd-numbered pins ① to ⑮</p>	①	T.M.D.S data 2+	⑪	T.M.D.S clock shield
	②	T.M.D.S data 2 shield	⑫	T.M.D.S clock -
	③	T.M.D.S data 2-	⑬	CEC
	④	T.M.D.S data 1+	⑭	—
	⑤	T.M.D.S data 1 shield	⑮	SCL
	⑥	T.M.D.S data 1-	⑯	SDA
	⑦	T.M.D.S data 0+	⑰	DDC/CEC GND
	⑧	T.M.D.S data 0 shield	⑱	+5V
	⑨	T.M.D.S data 0-		Hot plug detection
	⑩	T.M.D.S clock +		

Technical Information

List of compatible signals

The following table specifies the types of signals compatible with the projectors.

Format : V = VIDEO, S = S-VIDEO, C = COMPUTER, Y = YP_BPR, H = HDMI

Mode	Display resolution *1 (dots)	Scanning frequency		Dot clock frequency (MHz)	Picture quality *2	PnP *3	Format
		H (kHz)	V (Hz)				
NTSC/NTSC 4.43/ PAL-M/PAL 60	720 x 480	15.700	59.900	--	A		V/S
PAL/PAL-N/SECAM	720 x 576	15.600	50.000	--	A		V/S
480i	640 x 480i	15.734	60.000	12.273	A		C/Y
576i	768 x 576i	15.625	50.000	14.750	A		
480p	640 x 480	31.470	59.880	25.200	A		
576p	768 x 576	31.250	50.000	29.500	A		
720p	1 280 x 720	45.000	60.000	74.250	AA		
		37.500	50.000	74.250	AA		
1035i	1 920 x 1 035i	33.750	60.000	74.250	A		
1080i	1 920 x 1 080i	33.750	60.000	74.250	A		
		28.125	50.000	74.250	A		
VGA	640 x 400	31.470	70.090	25.175	A		
		31.470	59.880	25.149	A	○	
	640 x 480	37.860	72.810	31.500	A	○	
		37.860	74.380	31.500	A		
		37.500	75.000	31.500	A	○	
		43.269	85.000	36.000	A		
720 x 400	31.470	70.090	28.322	A			
SVGA	800 x 600	32.700	51.090	32.700	A		
		34.500	55.380	36.432	A		
		35.156	56.250	36.000	A	○	
		38.600	60.310	38.600	A		
		37.880	60.320	40.000	A	○	
		38.000	60.510	40.128	A		
		37.900	61.030	40.020	A		
		48.080	72.190	50.000	A	○	
		46.875	75.000	49.500	A	○	
MAC	1 280 x 960	75.000	75.080	126.000	A		
	1 280 x 1 024	80.000	75.080	135.200	A		
MAC 13	640 x 480	35.000	66.670	30.240	A		
MAC LC13		34.970	66.600	31.330	A		
MAC 16	832 x 624	49.720	74.550	57.283	A		
MAC 19	1 024 x 768	60.240	75.080	80.010	A		
MAC 21	1 152 x 870	68.680	75.060	100.000	A		
SXGA+	1 400 x 1 050	65.120	59.900	122.430	A		
		65.350	60.120	122.850	A		
		63.970	60.190	107.990	A		

Technical Information

Mode	Display resolution *1 (dots)	Scanning frequency		Dot clock frequency (MHz)	Picture quality *2	PnP *3	Format
		H (kHz)	V (Hz)				
XGA	1 024 x 768	44.000	54.580	59.129	A		C
		46.900	58.200	63.030	A		
		47.000	58.300	61.664	A		
		48.360	60.000	65.000	A	○	
		48.500	60.020	65.179	A		
		56.476	70.070	75.000	A	○	
		58.030	72.000	74.745	A		
		60.310	74.920	79.252	A		
		60.023	75.030	78.750	A	○	
		61.000	75.700	81.000	A		
		62.040	77.070	84.375	A		
		63.480	79.350	83.410	A		
	68.677	84.977	94.504	A			
	1 024 x 768i	35.522	86.960	44.900	A		
	36.000	87.170	47.300	A			
SXGA	1 152 x 864	64.200	70.400	94.560	A		
	1 152 x 900	61.200	65.200	92.000	A		
		61.850	66.000	94.500	A		
		71.400	75.600	105.100	A		
	1 280 x 960	60.000	60.000	108.000	A		
	1 280 x 1 024	62.500	58.600	108.000	A		
		63.340	59.980	108.180	A		
		63.900	60.000	107.350	A		
		63.370	60.010	111.520	A		
		63.740	60.010	109.497	A		
		63.980	60.020	108.000	A		
		63.790	60.180	108.190	A		
		71.690	67.190	117.004	A		
		76.970	72.000	130.080	A		
		79.976	75.025	135.000	A		
		81.130	76.107	135.008	A		
	91.146	85.024	157.500	A			
	1 280 x 1 024i	50.000	86.000	80.000	A		
46.430		86.700	78.745	A			
50.000		94.000	80.000	A			
UXGA	1 600 x 1 200	75.000	60.000	162.000	A		
		81.250	65.000	175.500	A		
		87.500	70.000	189.000	A		
		93.750	75.000	202.500	A		

Technical Information

Mode	Display resolution *1 (dots)	Scanning frequency		Dot clock frequency (MHz)	Picture quality *2	PnP *3	Format
		H (kHz)	V (Hz)				
WXGA	1 280 x 768	47.776	59.870	79.500	AA		C
		55.993	69.991	94.964	AA		
		57.675	72.004	97.817	AA		
		60.289	74.893	102.250	AA		
		68.633	84.837	117.500	AA		
	1 280 x 800	41.200	50.000	68.557	AA	○	
		49.702	59.810	83.500	AA		
		63.980	60.020	108.000	AA		
		49.600	60.050	79.360	AA		
		58.289	69.975	98.858	AA		
		60.044	71.995	102.795	AA		
		62.790	74.928	106.492	AA		
	71.553	84.879	122.498	AA			
	1 366 x 768	48.360	60.000	86.670	A		
	1 360 x 768	47.700	60.000	86.670	A		
		56.160	72.000	100.190	A		
1 376 x 768	48.360	60.000	86.670	A			
WSXGA+	1 680 x 1 050	65.290	59.954	146.250	A		
WXGA+	1 440 x 900	55.935	59.887	106.500	A		
		74.918	60.000	161.850	A		
WUXGA	1 920 x 1 200	74.556	59.885	193.250	A		
		74.038	59.950	154.000	A		
D-VGA	640 x 480	31.470	59.940	25.175	A	○	
D-480p		31.470	59.880	25.200	A	○	
D-576p	768 x 576	31.250	50.000	29.500	A	○	
D-720p	1 280 x 720	37.500	50.000	74.250	AA	○	
		45.000	60.000	74.250	AA	○	
D-1035i	1 920 x 1 035i	33.750	60.000	74.250	A		
D-1080i	1 920 x 1 080i	33.750	60.000	74.250	A	○	
		28.125	50.000	74.250	A	○	
D-1080p	1 920 x 1 080	27.000	24.000	74.250	A		
		67.500	60.000	148.500	A		
		56.250	50.000	148.500	A		
D-SVGA	800 x 600	37.879	60.320	40.000	A	○	
D-XGA	1 024 x 768	48.363	60.000	65.000	A	○	
D-SXGA+	1 400 x 1 050	65.120	59.900	122.430	A		
		65.350	60.120	122.850	A		
		63.970	60.190	107.990	A		

Mode	Display resolution *1 (dots)	Scanning frequency		Dot clock frequency (MHz)	Picture quality *2	PnP *3	Format
		H (kHz)	V (Hz)				
D-WXGA	1 360 x 768	47.700	60.000	86.670	A		H
		56.160	72.000	100.190	A		
	1 366 x 768	48.360	60.000	86.670	A		
		46.500	50.000	67.400	A		
	1 376 x 768	48.360	60.000	86.670	A		
	1 280 x 768	47.776	59.870	79.500	AA		
		55.993	69.991	94.964	AA		
		57.675	72.004	97.817	AA		
		60.289	74.893	102.250	AA		
	1 280 x 800	68.633	84.837	117.500	AA		
		41.200	50.000	68.557	AA		
		49.702	59.810	83.500	AA	○	
		49.572	59.870	83.282	AA		
		63.980	60.020	108.000	AA		
		58.289	69.975	98.858	AA		
		60.044	71.995	102.795	AA		
D-SXGA	1 280 x 1 024	62.790	74.928	106.492	AA		
		71.553	84.879	122.498	AA		
		31.650	29.800	53.480	A		
D-WXGA+	1 440 x 900	60.276	58.069	93.067	A		
		63.980	60.020	108.000	A		
D-WXGA+	1 440 x 900	55.935	59.887	106.500	A		
D-WSXGA+	1 680 x 1 050	65.290	59.954	146.250	A		
D-WUXGA	1 920 x 1 200	74.038	59.950	154.000	A		

*1 : "i" added to the resolution value indicates an interlaced signal.

*2 : Picture quality is indicated by the following symbols.

AA: Maximum picture quality can be obtained.

A: Signals are converted by the image processing circuit.

*3 : Where marked "○" signals indicates in Plug and Play is compatible with EDID of projector. Unmarked signals in Plug and Play may also be compliant if input terminals are written in the format list. Where Plug and Play is unmarked and nothing is written in the format list, difficulties in projecting image may occur even when computer and projector appear to have same resolution.
<COMPUTER 2 IN> terminal does not support Plug and Play.

Note

- The number of display dots is 1 280 x 800.
A signal with a different resolution will be projected after converting the resolution to match the projector display.
- When interlaced signals are connected, flicker may occur on the projected image.
- DIGITAL LINK and HDMI inputs share the same compatible signal.

Specifications

Model No.		PT-VW431DU																	
Power supply		AC100 V - 240 V 50 Hz/60 Hz																	
Power consumption		100 V - 240 V, 4.0 A-1.6 A 365 W When [Standby mode] of [Setting] is set to [Eco]: 0.3 W When [Standby mode] of [Setting] is set to [Network]: 12.5 W (When using DIGITAL LINK: 19.7 W) When [In standby mode] of [Sound] is set to [On]: 27.5 W																	
LCD panel	Panel size	1.5 cm (0.59") (aspect ratio 16 : 10)																	
	Display method	3 transparent LCD panels (RGB)																	
	Drive method	Active matrix method																	
	Pixels	1 024 000 (1 280 x 800) x 3 panels																	
Lens		Manual zoom (1.6x) / Manual focus / Lens shift F 1.6 to 2.12, f 15.28 mm to 24.62 mm																	
Luminous lamp		280 W UHM lamp																	
Light output *1		4 300 lm																	
Contrast ratio *2		3 500 : 1 (all white / all black)																	
Applicable scanning frequency *3	for RGB signal	Horizontal 15 kHz to 100 kHz, Vertical 50 Hz to 100 Hz Dot clock frequency: 140 MHz or less																	
	for YP _B Pr signal	<table border="0"> <tr> <td>[525i(480i)]</td> <td>Horizontal 15.75 kHz, Vertical 60 Hz</td> </tr> <tr> <td>[625i(576i)]</td> <td>Horizontal 15.63 kHz, Vertical 50 Hz</td> </tr> <tr> <td>[525p(480p)]</td> <td>Horizontal 31.50 kHz, Vertical 60 Hz</td> </tr> <tr> <td>[625p(576p)]</td> <td>Horizontal 31.25 kHz, Vertical 50 Hz</td> </tr> <tr> <td>[750(720)/60p]</td> <td>Horizontal 45.00 kHz, Vertical 60 Hz</td> </tr> <tr> <td>[750(720)/50p]</td> <td>Horizontal 37.50 kHz, Vertical 50 Hz</td> </tr> <tr> <td>[1125(1080)/60i]</td> <td>Horizontal 33.75 kHz, Vertical 60 Hz</td> </tr> <tr> <td>[1125(1080)/50i]</td> <td>Horizontal 28.13 kHz, Vertical 50 Hz</td> </tr> </table> <ul style="list-style-type: none"> ● HD/SYNC and V terminals are not compliant with 3 value composite SYNC 		[525i(480i)]	Horizontal 15.75 kHz, Vertical 60 Hz	[625i(576i)]	Horizontal 15.63 kHz, Vertical 50 Hz	[525p(480p)]	Horizontal 31.50 kHz, Vertical 60 Hz	[625p(576p)]	Horizontal 31.25 kHz, Vertical 50 Hz	[750(720)/60p]	Horizontal 45.00 kHz, Vertical 60 Hz	[750(720)/50p]	Horizontal 37.50 kHz, Vertical 50 Hz	[1125(1080)/60i]	Horizontal 33.75 kHz, Vertical 60 Hz	[1125(1080)/50i]	Horizontal 28.13 kHz, Vertical 50 Hz
	[525i(480i)]	Horizontal 15.75 kHz, Vertical 60 Hz																	
	[625i(576i)]	Horizontal 15.63 kHz, Vertical 50 Hz																	
	[525p(480p)]	Horizontal 31.50 kHz, Vertical 60 Hz																	
[625p(576p)]	Horizontal 31.25 kHz, Vertical 50 Hz																		
[750(720)/60p]	Horizontal 45.00 kHz, Vertical 60 Hz																		
[750(720)/50p]	Horizontal 37.50 kHz, Vertical 50 Hz																		
[1125(1080)/60i]	Horizontal 33.75 kHz, Vertical 60 Hz																		
[1125(1080)/50i]	Horizontal 28.13 kHz, Vertical 50 Hz																		
for Video signal (including S-video)	Horizontal 15.75 kHz / 15.63 kHz, Vertical 60 Hz / 50 Hz																		
for HDMI signal	525p(480p), 625p(576p), 750(720)/60p, 750(720)/50p, 1125(1080)/60i, 1125(1080)/50i, 1125(1080)/24p, 1125(1080)/60p, 1125(1080)/50p <ul style="list-style-type: none"> ● Displayable resolution: VGA to WUXGA (non-interlace) ● Dot clock frequency: up to 162 MHz 																		
Color system	7 (NTSC, NTSC4.43, PAL, PAL-N, PAL-M, SECAM, PAL60)																		
Projection size	0.76 m -7.62 m (30"-300")																		
Screen aspect ratio	16 : 10																		
Projection scheme	Front / Rear / Mount on Ceiling / Floor (Menu setting system)																		
Speaker	1 (4.0 cm round-type)																		
Maximum usable volume output	10 W																		

*1 : These values of light output are measured under the condition that [Lamp power] is set to [Normal], [Image select] is set to [Dynamic] and [Lens Shift] is adjusted to the lowest level. Measurement, measuring conditions and method of notation all comply with ISO21118 international standards.

*2 : The value of contrast ratio is measured under the condition that [Lamp power] is set to [Normal], [Image select] is set to [Dynamic], [Lens Shift] is adjusted to the lowest level and [Iris] is set to [On].

*3 : For details of video signals that can be projected using this projector, refer to "List of compatible signals".
(➡ pages 94-97)

Model No.		PT-VW431DU
Terminals	COMPUTER 1 IN/ COMPONENT IN	1 (D-sub 15 pin female) [RGB signal] 0.7 V [p-p] 75 Ω (When G-SYNC: 1.0 V [p-p] 75 Ω) HD/SYNC TTL high impedance, automatic positive/negative polarity compatible VD TTL high impedance, automatic positive/negative polarity compatible [YPbPr signal] Y: 1.0 V [p-p] including synchronization signal, PbPr: 0.7 V [p-p] 75 Ω
	COMPUTER 2 IN/ MONITOR OUT	[RGB signal] 0.7 V [p-p] 75 Ω (When G-SYNC: 1.0 V [p-p] 75 Ω) HD/SYNC TTL high impedance, automatic positive/negative polarity compatible VD TTL high impedance, automatic positive/negative polarity compatible
	VIDEO IN	1 (Pin jack 1.0 V [p-p] 75 Ω)
	S-VIDEO IN	1 (Mini DIN 4 pin, Y 1.0 V [p-p], C 0.286 V [p-p] 75 Ω, S1 signal compatible)
	HDMI IN	HDMI 19-pin x 1 (HDCP and Deep Color compatible)
	AUDIO IN	2 (M3 stereo mini jack, 0.5 V [rms], input impedance 22 kΩ and more) 1 (Pin jack x 2 (L-R), 0.5 V [rms], input impedance 22 kΩ and more)
	VARIABLE AUDIO OUT	1 (M3 stereo mini jack, stereo monitor output compatible, 0 V [rms] to 2.0 V [rms] valuable, output impedance 2.2 kΩ and less)
	SERIAL IN	D-sub 9-pin x 1 for external control (RS-232C compliant)
	LAN/DIGITAL LINK	1 (RJ-45 network connection, DIGITAL LINK *4 connection , compliant with PLink
Power cable length		2.0 m (78 3/4")
Cabinet		Molded plastic
Dimensions		Width: 379 mm (14.92") Height: 107 mm (4.21") (when front adjustable feet shortened) Depth: 305 mm (12.01") (excluding protractions)
Weight		Approx.4.8 kg (10.58 lbs.) *5
Operating environment		Operating environment temperature *6: 0 °C (32 °F) to 40 °C (104 °F) (Elevation: below 1 200 m; [Fan control]: [Off]) 0 °C (32 °F) to 30 °C (86 °F) (Elevation: 1 200 m ~ 2 000 m; [Fan control]: [On 1]) 0 °C (32 °F) to 30 °C (86 °F) (Elevation: 2 000 m ~ 2 700 m; [Fan control]: [On 2]) Operating environment humidity: 20 % to 80 % (no condensation)
Remote control	Power supply	DC 3 V (battery (AAA/R03 or AAA/LR03 Type) x 2)
	Operating range	Approx. 7 m (275.6") (when operated directly in front of receptor)
	Weight	67 g (2.36 ozs.) (including batteries)
	Dimensions	Width : 52 mm (2.05"), Length : 110 mm (4.33"), Height : 18 mm (0.71")

*4 : DIGITAL LINK is a technology to send image and sound signals via twisted pair cable.

The optional accessory Digital Interface Box (ET-YFB100G) and Extron's XTP transmitter are only matched for this projector. For twisted-pair-cable transmitter of other manufacturers of which the operation has been verified with the DIGITAL LINK compatible projector, refer to Panasonic website (<http://panasonic.net/avc/projector/>). Note that the verification for devices of other manufacturers has been made for the items set by Panasonic Corporation, and not all the operations have been verified. For operation or performance problems caused by the devices of other manufacturers, contact the respective manufacturers.

*5 : This is an average value. It may differ depending on individual product.

*6 : If [Lamp power] is set to [Normal] and the operating environment temperature exceeds 35 °C (95 °F), [Lamp power] may be changed to [Eco] automatically.

- The part numbers of accessories and separately sold components are subject to change without notice.

Specifications

Dimensions

<Unit : mm>

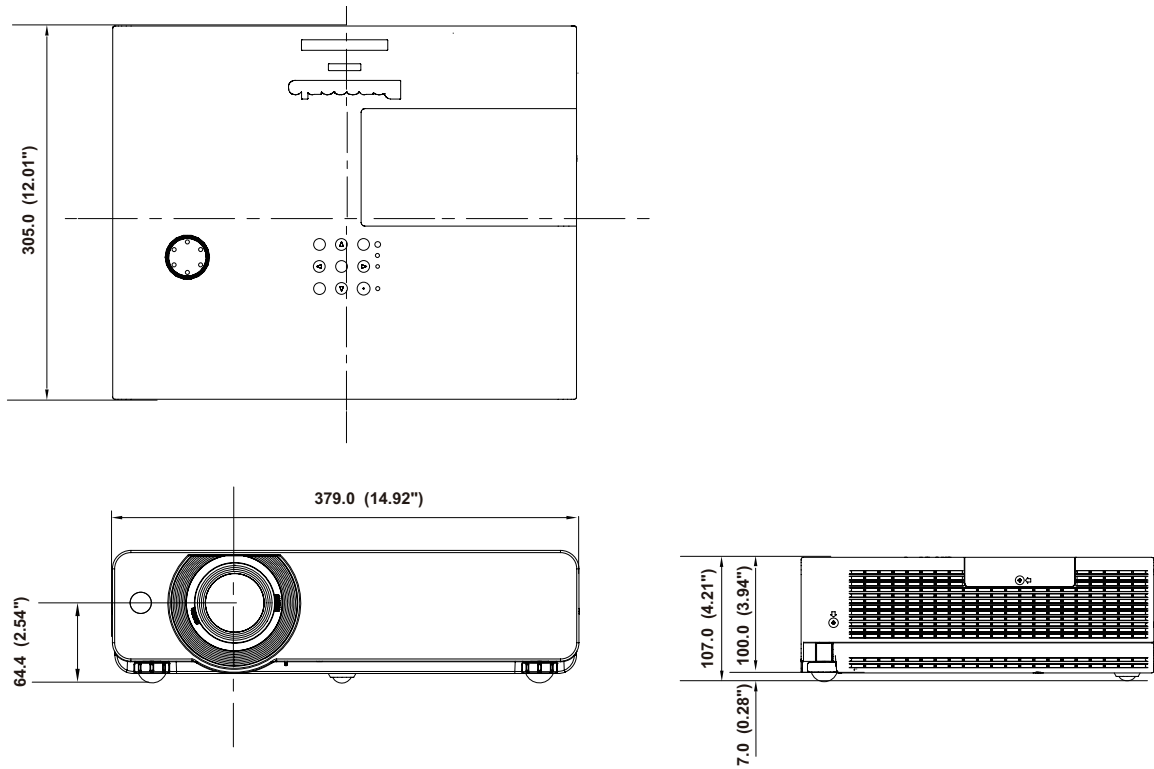

*: Actual dimension may differ by product.

Ceiling mount bracket safeguards

- Installation work of the ceiling mount bracket should only be carried by a qualified technician.
- Even if it is during guaranteed period, the manufacturer is not responsible for any hazard or damage caused by using a ceiling mount bracket which is not purchased from an authorized distributors, or environmental conditions.
- Remove an unused ceiling mount bracket promptly.
- Ensure to use a torque driver and do not use an electrical screwdriver or an impact screwdriver.
- For details, see the work instruction manual packed together with the ceiling mount bracket.
- The model Nos. of the accessories and the parts sold separately are subject to change without notice.
- Make sure the screws on the ceiling mount kit cannot touch the metal parts materials (metallic lath, wire or board) in the ceiling board. Otherwise it may result in fire hazard.

Bottom view

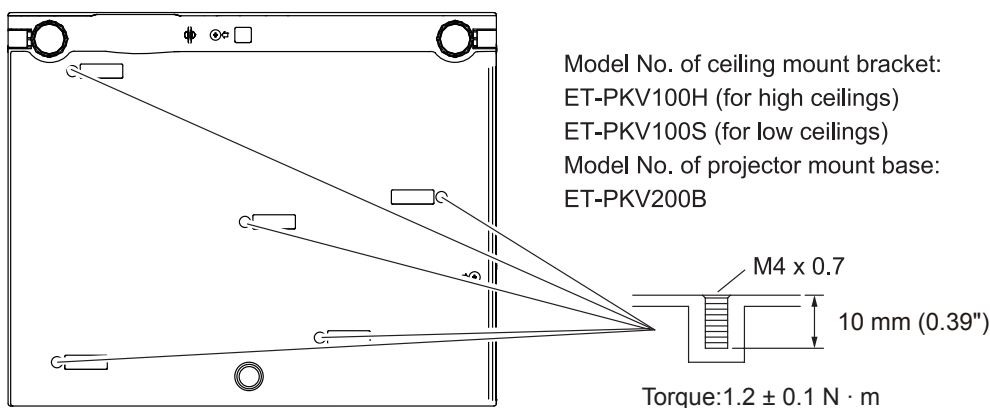

Index

A			
About Your Projector.....	17		
Accessories	15		
Adjusting front adjustable feet	25		
Adjusting the position by using the vertical lens shift function.....	25		
Attaching the Lens Cap	84		
AUTO PC adjust	42		
Auto setup	53		
B			
Background	54		
Basic operations by using the remote control	33		
Blackboard(Green)	45		
Brightness.....	46		
C			
Cautions on use.....	14		
Cautions when installing.....	12		
Cautions when transporting.....	12		
CD-ROM.....	16		
Ceiling.....	51		
Cinema	45		
Closed caption.....	57		
Color	46		
Colorboard.....	45		
Color temp.....	47		
Connecting	26		
Connecting the power cord.....	27		
Contrast.....	46		
Control panel and Indicators.....	19		
Custom	49		
Custom adj.	50		
D			
Daylight View.....	47		
Digital Interface Box	64		
DIGITAL LINK.....	40		
DIGITAL LINK mode	62		
DIGITAL LINK setup	62		
DIGITAL LINK signal level	55		
DIGITAL LINK status	62		
Digital zoom.....	50		
Direct on	56		
Direct Power Off function.....	31		
Display.....	54		
Dynamic.....	45		
E			
Emulate	59		
Extron XTP	64		
F			
Factory default.....	60		
Fan	58		
Fan control.....	58		
Filter counter.....	59		
For component input.....	41		
For computer input	40		
For video and S-video input.....	41		
FREEZE	34		
Full.....	49		
G			
Gamma.....	48		
H			
HDMI setup.....	55		
How to adjust the state of the image	32		
I			
ID numbers	21		
Image adjust.....	46		
Image select	45		
Information.....	61		
Input menu.....	40		
Input search.....	53		
Installing and Removing batteries ..	21		
In standby mode	52		
Iris.....	46		
K			
Keystone.....	34, 50		
L			
LAMP indicator	79		
Lamp power.....	57		
Lamp unit.....	82		
Language.....	53		
List of compatible signals	94		
Logo.....	54		
M			
Main menu.....	38		
Maintenance	80		
Managing the indicated problems..	79		
Manual PC adjust	43		
Menu Navigation.....	37		
Menu position	53		
MIC	52		
Mute.....	52		
N			
Natural wide.....	49		
Network	62		
Network connections	65		
Noise reduction.....	48		
Normal	49		
O			
ON(G)/STANDBY(R) indicator.....	28		
Other terminals	93		
P			
PIN code.....	30		
Power management	55		
Precautions for Use.....	12		
Progressive.....	48		
Projecting.....	32		
Projection distance	23		
Projection method.....	22		
Projector body	18		
P-timer	56		
R			
Read this first!.....	2		
Real	45		
Rear.....	51		
Rear terminals	20		
Remote control	17, 57		
Replacing the Lamp unit.....	83		
Replacing the unit.....	80		
RS232C	60		
S			
Screen	49		
Screen aspect.....	51		
Screen size and throw distance.....	23		
Security.....	13, 57		
Selecting the input signal.....	32		
Serial terminal.....	90		
Setting	53		
Setting the ID number.....	21		
Setting up	22		
Sharpness	48		
Sound	52		
Specifications	98		
Standard.....	45		
Standby mode	56		
Sub menu	38		
Switching the input signal.....	33		
System.....	40		
T			
Terminal.....	55		
Tint.....	46		
Troubleshooting.....	85		
True	49		
Turning Off the Projector	31		
Turning On the Projector	29		
Twisted pair cable Extender connections.....	66		
V			
Video delay control	59		
Volume.....	52		
W			
WARNING indicator.....	79		
Warning log	60		
Wide(16:9).....	49		
Z			
Zoom	49		

Information on Disposal in other Countries outside the European Union



These symbols are only valid in the European Union.

If you wish to discard this product, please contact your local authorities or dealer and ask for the correct method of disposal.



EU



Environment care information for users in China



This symbol is only valid in China.

Panasonic Corporation

Web Site : <http://panasonic.net/avc/projector/>

Panasonic Systems Communications Company of North America

One Panasonic Way 2F-13, Secaucus, NJ 07094

TEL: (877) 803 - 8492

Panasonic Canada Inc.

5770 Ambler Drive, Mississauga, Ontario L4W 2T3

TEL: (905) 624 - 5010