

Panasonic®

Operating Instructions Functional Manual

DLP™ Projector Commercial Use

Model No. **PT-TW330EA**
PT-TW240EA
PT-TX300EA

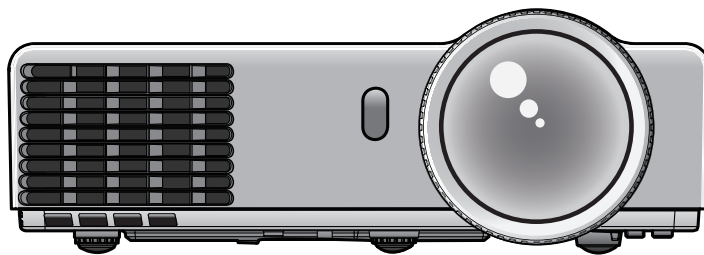

Thank you for purchasing this Panasonic Product.

- This manual is intended for products manufactured from Nov. 2013 and beyond.
- Before operating this product, please read the instructions carefully, and save this manual for future use.
- Before using your projector, be sure to read “Read this first!” (See pages 2 to 8).

ENGLISH

TQBJ0624-1

Read this first!

WARNING: THIS APPARATUS MUST BE EARTHED.

WARNING: To prevent damage which may result in fire or shock hazard, do not expose this appliance to rain or moisture.
This device is not intended for use in the direct field of view at visual display workplaces. To avoid incommoding reflexions at visual display workplaces this device must not be placed in the direct field of view.
The equipment is not intended for used at a video workstation in compliance BildscharbV.

The sound pressure level at the operator position is equal or less than 70 dB (A) according to ISO 7779.

WARNING:

1. Remove the plug from the mains socket when this unit is not in use for a prolonged period of time.
2. To prevent electric shock, do not remove cover. No user serviceable parts inside. Refer servicing to qualified service personnel.
3. Do not remove the earthing pin on the mains plug. This apparatus is equipped with a three prong earthing type mains plug. This plug will only fit an earthing-type mains socket. This is a safety feature. If you are unable to insert the plug into the mains socket, contact an electrician. Do not defeat the purpose of the earthing plug.

CAUTION: To assure continued compliance, follow the attached installation instructions. The user must use the provided RGB computer interface cable with ferrite cores. Any unauthorized changes or modifications to this equipment will void the user's authority to operate.

This is a device to project images onto a screen, etc., and is not intended for use as indoor lighting in a domestic environment.

Directive 2009/125/EC

IMPORTANT: THE MOULDED PLUG (U.K. only)

FOR YOUR SAFETY, PLEASE READ THE FOLLOWING TEXT CAREFULLY.

This appliance is supplied with a moulded three pin mains plug for your safety and convenience. A 13 amp fuse is fitted in this plug. Should the fuse need to be replaced, please ensure that the replacement fuse has a rating of 13 amps and that it is approved by ASTA or BSI to BS1362.

Check for the ASTA mark  or the BSI mark  on the body of the fuse.

If the plug contains a removable fuse cover, you must ensure that it is refitted when the fuse is replaced. If you lose the fuse cover, the plug must not be used until a replacement cover is obtained. A replacement fuse cover can be purchased from an Authorised Service Center.

If the fitted moulded plug is unsuitable for the mains socket in your home, then the fuse should be removed and the plug cut off and disposed of safely. There is a danger of severe electrical shock if the cut off plug is inserted into any 13 amp socket.

If a new plug is to be fitted, please observe the wiring code as shown below.
If in any doubt, please consult a qualified electrician.

WARNING: THIS APPLIANCE MUST BE EARTHED.

IMPORTANT: The wires in this mains lead are coloured in accordance with the following code:

Green - and - Yellow:	Earth
Blue:	Neutral
Brown:	Live

As the colours of the wire in the mains lead of this appliance may not correspond with the coloured markings identifying the terminals in your plug, proceed as follows.

The wire which is coloured GREEN - AND - YELLOW must be connected to the terminal in the plug which is marked with the letter E or by the Earth symbol  or coloured GREEN or GREEN - AND - YELLOW.

The wire which is coloured BLUE must be connected to the terminal in the plug which is marked with the letter N or coloured BLACK.

The wire which is coloured BROWN must be connected to the terminal in the plug which is marked with the letter L or coloured RED.

How to replace the fuse: Open the fuse compartment with a screwdriver and replace the fuse.

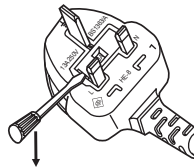

Read this first!

WARNING:

■ POWER

The wall outlet or the circuit breaker shall be installed near the equipment and shall be easily accessible when problems occur. If the following problems occur, cut off the power supply immediately.

Continued use of the projector in these conditions will result in fire or electric shock.

- If foreign objects or water get inside the projector, cut off the power supply.
 - If the projector is dropped or the cabinet is broken, cut off the power supply.
 - If you notice smoke, strange smells or noise coming from the projector, cut off the power supply.
- Please contact an Authorized Service Center for repairs, and do not attempt to repair the projector yourself.

During a thunderstorm, do not touch the projector or the cable.

Electric shocks can result.

Do not do anything that might damage the power cord or the power plug.

If the power cord is used while damaged, electric shocks, short-circuits or fire will result.

- Do not damage the power cord, make any modifications to it, place it near any hot objects, bend it excessively, twist it, pull it, place heavy objects on top of it or wrap it into a bundle.

Ask an Authorized Service Center to carry out any repairs to the power cord that might be necessary.

Completely insert the power plug into the wall outlet and the power connector into the projector terminal.

If the plug is not inserted correctly, electric shocks or overheating will result.

- Do not use plugs which are damaged or wall outlets which are coming loose from the wall.

Do not use anything other than the provided power cord.

Failure to observe this will result in fire or electric shocks. Please note that if you do not use the provided power cord to ground the device on the side of the outlet, this may result in electric shocks.

Clean the power plug regularly to prevent it from becoming covered in dust.

Failure to observe this will cause a fire.

- If dust builds up on the power plug, the resulting humidity can damage the insulation.
- If not using the projector for an extended period of time, pull the power plug out from the wall outlet.

Pull the power plug out from the wall outlet and wipe it with a dry cloth regularly.

Do not handle the power plug with wet hands.

Failure to observe this will result in electric shocks.

Do not overload the wall outlet.

If the power supply is overloaded (ex., by using too many adapters), overheating may occur and fire will result.

■ ON USE/INSTALLATION

Do not place liquid containers on top of the projector.

If water spills onto the projector or gets inside it, fire or electric shocks will result.

If any water gets inside the projector, contact an Authorized Service Center.

Do not place the projector on soft materials such as carpets or sponge mats.

Doing so will cause the projector to overheat, which can cause burns, fire or damage to the projector.

Do not set up the projector in humid or dusty places or in places where the projector may come into contact with oily smoke or steam, ex. a bathroom.

Using the projector under such conditions will result in fire, electric shocks or components deterioration.

Components deterioration (such as ceiling mount brackets) may cause the projector which is mounted on the ceiling to fall down.

Do not install this projector in a place which is not strong enough to take the full weight of the projector or on top of a surface which is sloped or unstable.

Failure to observe this will cause projector to fall down or tip over the projector, and severe injury or damage could result.

Do not place another projector or other heavy objects on top of the projector.

Failure to observe this will cause the projector to become unbalanced and fall, which could result in damage or injury. The projector will be damaged or deformed.

WARNING:**Installation work (such as ceiling mount bracket) should only be carried out by a qualified technician.**

If installation is not carried out and secured correctly it can cause injury or accidents, such as electric shocks.

- Do not use anything other than an authorized ceiling mount bracket.
- Be sure to use the wire provided with the projector mount bracket for ceiling mount as an extra safety measure to prevent the projector from falling down. (Install in a different location to the ceiling mount bracket.)

Do not cover the air intake port or the air exhaust port.

Doing so will cause the projector to overheat, which can cause fire or damage to the projector.

- Do not place the projector in narrow, badly ventilated places.
- Do not place the projector on cloth or papers, as these materials could be drawn into the air intake port.

Do not place your hands or other objects close to the air exhaust port.

Doing so will cause burns or damage your hands or other objects.

- Heated air comes out of the air exhaust port. Do not place your hands or face, or objects which cannot withstand heat close to this port.

Do not look and place your skin into the lights emitted from the projection window while the projector is being used.

Doing so can cause burns or loss of sight.

- Strong light is emitted from the projector's projection window. Do not look or place your hands directly into this light.
- Be especially careful not to let young children look into the projection window. In addition, turn off the power and disconnect the power plug when you are away from the projector.

Do not insert any foreign objects into the projector.

Doing so will cause fire or electric shocks.

- Do not insert any metal objects or flammable objects into the projector or drop them onto the projector.

Never attempt to remodel or disassemble the projector.

High voltages can cause fire or electric shocks.

- For any inspection, adjustment and repair work, please contact an Authorized Service Center.

Do not allow metal objects, flammable objects, or liquids to enter inside of the projector. Do not allow the projector to get wet.

Doing so may cause short circuits or overheating, and result in fire, electric shock, or malfunction of the projector.

- Do not place containers of liquid or metal objects near the projector.
- If liquid enters inside of the projector, consult your dealer.
- Particular attention must be paid to children.

Use the ceiling mount bracket specified by Panasonic.

Defects in the ceiling mount bracket will result in falling accidents.

- Attach the supplied safety cable to the ceiling mount bracket to prevent the projector from falling down.

Do not touch around the lamp and the air exhaust port.

- Doing so will cause burns or damage your hands, because the temperature is very high when the lamp is lighting and for a while after the lamp is turned off.

Do not touch the flexible foam or remove it from the cabinet bottom.

- Doing so will cause burns or damage your hands, because the temperature is very high when the lamp is lighting and for a while after the lamp is turned off.

Read this first!

WARNING:

■ ACCESSORIES

Do not use or handle the battery improperly, and refer to the following.

Failure to observe this will cause burns, battery to leak, overheat, explode or catch fire.

- Do not use unspecified battery.
- Do not disassemble coin cell battery.
- Do not heat the battery or place them into water or fire.
- Do not allow the + and – terminals of the battery to come into contact with metallic objects such as necklaces or hairpins.
- Do not bring or store battery together with metallic objects.
- Store the battery in a plastic bag and keep them away from metallic objects.
- Make sure the polarities (+ and –) are correct when inserting the battery.
- Remove the empty battery from the remote control at once.
- Insulate the battery using tape or something similar before disposal.

Do not allow children to reach the battery (CR2025).

- The battery can cause personal injury if swallowed.
- If swallowed, seek medical advice immediately.

If the battery fluid leaks, do not touch it with bare hands, and take the following measures if necessary.

- Battery fluid on your skin or clothing could result in skin inflammation or injury.
Rinse with clean water and seek medical advice immediately.
- Battery fluid coming in contact with your eyes could result in loss of sight.
In this case, do not rub your eyes. Rinse with clean water and seek medical advice immediately.

Do not disassemble the lamp unit.

If the lamp breaks, it could cause injury.

Do not remove unspecified screws during the lamp unit replacement.

Doing so can cause electric shocks, burns, or injury.

Lamp replacement

The lamp has high internal pressure. If improperly handled, an explosion and severe injury or accidents will result.

- The lamp can easily explode if struck against hard objects or dropped.
- Before replacing the lamp, be sure to disconnect the power plug from the wall outlet.
Electric shocks or explosions can result if this is not done.
- When replacing the lamp, turn the power off and allow the lamp it to cool for at least 1 hour before handling it otherwise it can cause burns.

Do not allow infants or pets to touch the remote control unit.

- Keep the remote control unit out of the reach of infants and pets after using it.

Do not use the supplied power cord with devices other than this projector.

- Using the supplied power cord with devices other than this projector may cause short circuits or overheating, and result in electric shock or fire.

Remove the depleted battery from the remote control promptly.

- Leaving them in the unit may result in fluid leakage, overheating, or explosion of the battery.

CAUTION:**■ POWER**

When disconnecting the power cord, be sure to hold the power plug and power connector.

If the power cord itself is pulled, the lead will become damaged, and fire, short-circuits or serious electric shocks will result.

When not using the projector for an extended period of time, disconnect the power plug from the wall outlet.

Failure to do so may result in fire or electric shock.

Disconnect the power plug from the wall outlet before carrying out any cleaning and replacing the unit.

Electric shocks can result if this is not done.

■ ON USE/INSTALLATION

Do not put your weight on this projector.

You could fall or the projector could break, and injury will result.

- Be especially careful not to let young children stand or sit on the projector.

Do not place the projector in extremely hot locations.

Doing so will cause the outer casing or internal components to deteriorate, or result in fire.

- Take particular care in locations exposed to direct sunlight or near stoves.

Always disconnect all cables before moving the projector.

Moving the projector with cables still attached can damage the cables, which will cause fire or electric shocks to occur.

Never plug headphones and earphones into VARIABLE AUDIO OUT jack.

Excessive sound pressure from earphones and headphones can cause hearing loss.

■ ACCESSORIES

Do not use the old lamp unit.

If used it could cause lamp explosion.

If the lamp has broken, ventilate the room immediately. Do not touch or bring your face close to the broken pieces.

Failure to observe this will cause the user to absorb the gas which was released when the lamp broke and which contains nearly the same amount of mercury as fluorescent lamps, and the broken pieces will cause injury.

- If you believe that you have absorbed the gas or that the gas has got into your eyes or mouth, seek medical advice immediately.
- Ask your dealer about replacing the lamp unit and check the inside of the projector.

When not using the projector for an extended period of time, remove the battery from the remote control.

- Failure to observe this will cause the battery to leak, overheat, catch fire or explode, which may result in fire or contamination of surrounding area.

Do not open the desiccant bag or eat it, and do not discard it to moisture circumstances.

Accidentally swallow the contents of the desiccant bag may cause bad result to your body. Moreover, the contents may generate heat if exposing to moisture, so it may cause inflammation or injury to your skin if such contents is attached to your body or clothes.

- In case that the desiccant has got into your eyes or mouth, wash with clean water immediately and seek medical advice.
- Particular attention must be paid to children.

Read this first!



To remove the battery

Remote Control Battery

1. Press the guide and pull out the battery base.

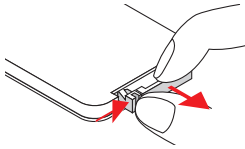

2. Remove the battery.

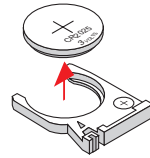

Trademarks

- Windows®, Windows Vista®, and Internet Explorer® are registered trademarks or trademarks of Microsoft Corporation in the United States and other countries.
- Macintosh, Mac, Mac OS, OS X and Safari are registered trademarks of Apple Inc. in the United States and other countries.
- HDMI, the HDMI Logo, and High-Definition Multimedia Interface are trademarks or registered trademarks of HDMI Licensing LLC in the United States and other countries.



- PJLink™ is a trademark or pending trademark in Japan, the United States, and other countries and regions.
- RoomView, Crestron RoomView are registered trademarks of Crestron Electronics, Inc, and Crestron Connected is the trademark of Crestron Electronics, Inc.
- Other names, company names or product names used in these operating instructions are the trademarks or registered trademarks of their respective holders.

Please note that the operating instructions do not include the ® and ™ symbols.

Illustrations in these operating instructions

- Note that illustrations of the projector and screens may differ from the ones you actually see.

Page references

- In these instructions, references to pages are indicated as: (▶ page 00).

Term

- In these instructions, the “Wireless remote control unit” accessory is referred to as the “Remote control”.

Features of the Projector

Superb Basic Performance

- ▶ Up to 3 100 lm*¹ of brightness in a compact body, weighting 2.5 kg.
- ▶ High contrast ratio up to 7 500:1*² makes images with excellent detail and depth.
- ▶ Quiet 29 dB design does not interrupt meetings or classes.
([Lamp Power Mode]: [ECO]*³)
(*1: 3 100 lm is for PT-TW330E.
2 700 lm is for PT-TW240E.
3 000 lm is for PT-TX300E.)
(*2: For RGB signal input, set [Color Mode] to [Dynamic] and [Lamp Power Mode] to [Auto].)
(*3: [ECO2] is for PT-TW330E and PT-TX300E.)

Eco Friendly Performance

- ▶ The Intelligent Lamp Control System reduces power consumption and extends the lamp replacement cycle. ([Lamp Power Mode]: [Auto])

Quick steps

For details, see the corresponding pages.

1. **Set up your projector.**
(⇒ page 21)



2. **Connect with other devices.**
(⇒ page 25)



3. **Connect the power cord.**
(⇒ page 27)



4. **Power on.**
(⇒ page 29)



5. **Select the input signal.**
(⇒ page 30)



6. **Adjust the image.**
(⇒ page 30)

Contents

Be sure to read "Read this first!". (→ pages 2 to 8)

Important Information

Read this first!	2
Contents	10
Precautions for Use	12
Cautions when transporting.....	12
Cautions when installing.....	12
Security	13
Disposal.....	13
Cautions on use	14
Accessories	15
Optional accessories	15

Preparation

About Your Projector	16
Remote control	16
Projector body	17
Control Panel and Indicators	18
Connecting terminals.....	19
Using Remote control	20
Installing and Removing battery	20
Setting Remote control ID numbers	20

Getting Started

Setting up	21
Projection method	21
Parts for ceiling mount (Optional).....	21
Screen size and throw distance	22
Adjusting the Projector's Height	24
Connections	25
Before connecting to the projector	25
Connecting example: Computers	26
Connecting example: AV equipment	26

Basic Operation

Powering ON/OFF	27
Connecting the power cord	27
ON(G)/STANDBY(R) indicator.....	28
Powering On the Projector	29
Powering Off the Projector	29
Projecting	30
Selecting the input signal	30
How to adjust the state of the image	30

Basic operations by using the remote control..... 31

Switching the input signal.....	31
<LAMP> button	31
<INFO.> button.....	31
<FREEZE> button	31
<KEystone> buttons	31
<IMAGE> button.....	32
<INPUT> button	32
<MENU> button.....	32
<AUTO ADJ.> button.....	32
<MUTE> button	32
<ASPECT> button	32
<AV MUTE> button	32
<VOLUME> buttons	32

Settings

On-screen Display Menus	33
How to operate menu	33
Menu Tree	34
Picture	36
Color Mode.....	36
Wall color.....	36
Brightness	36
Contrast.....	36
Sharpness	36
Saturation	37
Hue.....	37
Gamma.....	37
Color Temp	37
Color Space.....	37
Position	38
Aspect Ratio	38
Phase	38
Clock	38
H Position	38
V Position	39
Digital Zoom	39
V Keystone	39
Ceiling Mount	39
Setting	40
Language	40
Menu Location.....	40
Closed Caption.....	40
VGA Out (Standby).....	40
Test Pattern	40
Remote ID	41
Startup Logo.....	41

Important Information

Preparation

Getting Started

Basic Operation

Settings

Maintenance

Appendix

UART Mode.....	41
LAN (Standby).....	41
Reset.....	41
Audio	42
Mute	42
Volume	42
In Standby Mode (Audio).....	42
Options.....	43
Auto Source.....	43
Input	43
Auto Power Off (Min).....	43
Lamp Settings	43
High Altitude	44
Dust Filter Reminder	44
Information	44
LAN	45
DHCP	45
IP Address	45
Subnet Mask	45
Gateway	45
DNS.....	45
Store.....	46
Reset.....	46
Connect to Network.....	47
Computer operation via network	48
Web Management	48

Maintenance

About indicator status	52
If an indicator turns on.....	52
Maintenance/replacement.....	53
Before cleaning/replacing the unit.....	53
Maintenance.....	53
Replacing the unit.....	55
Troubleshooting	58

Appendix

Appendix	61
Serial terminal	61
Other terminals.....	64
PJLink protocol.....	65
List of compatible signals	66
Specifications	68
Dimensions.....	70
Ceiling mount bracket safeguards.....	70
Index	71

Precautions for Use

Cautions when transporting

- When transporting the projector, hold it securely by its bottom and avoid excessive vibration and impacts. Doing so may damage the internal parts and result in malfunctions.
- Do not transport the projector with the adjustable feet extended. Doing so may damage the adjustable feet.

Cautions when installing

■ Do not set up the projector outdoors.

The projector is designed for indoor use only.

■ Do not use under the following conditions.

- Places where vibration and impacts occur such as in a car or vehicle: Doing so may damage the internal parts and result in malfunctions.
- Near the exhaust of an air conditioner: Depending on the conditions of use, the screen may fluctuate in rare cases due to the hot air from the air exhaust port or the heated or cooled air. Make sure that the exhaust from the projector or other equipment, or the air from the air conditioner does not blow toward the front of the projector.
- Near lights (studio lamps, etc.) and other locations of great temperature fluctuation (“Operating environment” (➡ page 69)): Doing so may shorten the life of the lamp or result in deformation of the outer case and malfunctions.
- Near high-voltage power lines or near motors: Doing so may interfere with the operation of the projector.
- Place where there is high-power laser equipment: Directing a laser beam onto the lens surface causes damage to the DLP chips.

■ Be sure to ask a specialized technician when installing the product to a ceiling.

This requires an optional ceiling mount bracket.

Model No.: ET-PKV100H (for high ceilings), ET-PKV100S (for low ceilings),
ET-PKL300B (Projector Mount Bracket)

■ Lens focus

The high clarity projection lens is thermally affected by the light from the light source, making the focus unstable in the period just after switching on the power. Wait at least 30 minutes with the image projected before adjusting the lens focus.

■ When using the projector at elevations below approx. 1 000 m (3 300 ft), make sure [High altitude] is set to [Off].

Failure to do so may shorten the life of the internal parts and result in malfunctions.

■ When using the projector at elevations approx. 1 000 m (3 300 ft) and approx. 3 000 m (10 000 ft), make sure [High altitude] is set to [On].

Failure to do so may shorten the life of the internal parts and result in malfunctions.

■ Do not install the projector at elevations approx. 3 000 m (10 000 ft) or higher above sea level.

Failure to do so may shorten the life of the internal parts and result in malfunctions.

■ Confirm and set the using environment temperature [“Operating environment” (➡ page 69)].

Do not tilt the projector or place it on its side.

Do not tilt the projector body more than approximately $\pm 10^\circ$ vertically or $\pm 20^\circ$ horizontally. Over-tilting may result in shortening the life of the components.

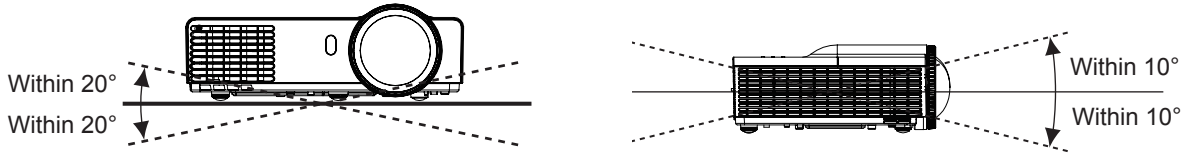

Cautions when setting the projectors

- Do not stack the projectors.
- Do not block the ventilation ports (intake and exhaust) of the projector.
- Avoid heating and cooling air from the air conditioning system directly blow to the ventilation ports (intake and exhaust) of the projector.

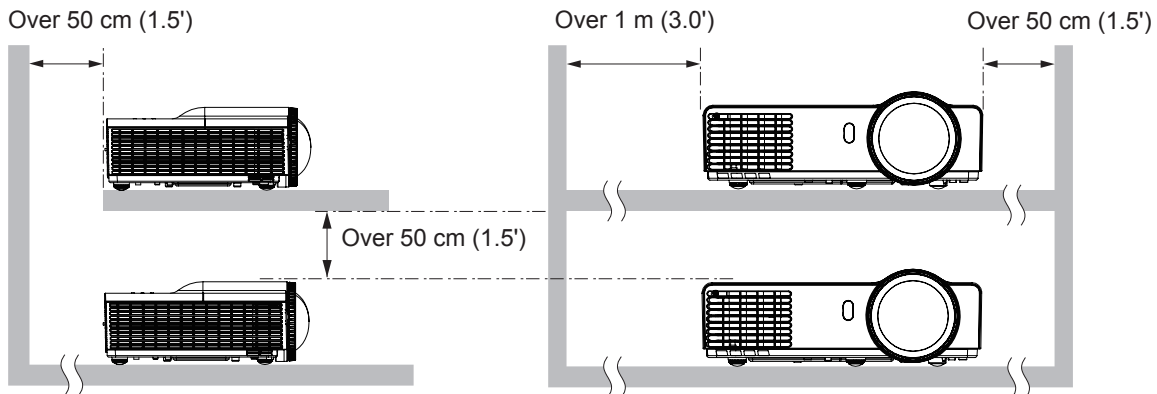

- Do not install the projector in a confined space.
When placing the projector in a confined space, a ventilation and/or air conditioning system is required. Exhaust heat may accumulate when the ventilation is not enough, triggering the protection circuit of the projector.

Security

Take safety measures against following incidents.

- Personal information being leaked via this product.
- Unauthorized operation of this product by a malicious third party.
- Interfering or stopping of this product by a malicious third party.

Security instruction (►page 50)

- Make your password as difficult to guess as possible.
- Change your password periodically.
- Panasonic or its affiliate company never inquires a password directly to a customer. Do not tell your password in case you receive such an inquiry.
- The connecting network must be secured by firewall or others.
- Set an administrator password for the Web Management and restrict the users who can log in.

Disposal

When disposing of the product, ask your local authority or dealer about the correct methods of disposal. The lamp contains mercury. When disposing of the used lamp unit, ask your nearest local authorities or dealer about proper disposal of the unit.

Dispose of used battery according to the instructions or your local disposal rule or guidelines.

Precautions for Use

Cautions on use

■ In order to get the picture quality

- Draw curtains or blinds over windows and turn off any lights near the screen to prevent outside light or light from indoor lamps from shining onto the screen.
- Depending on where the projector is used, heated air from an exhaust port or warm or cold air from an air conditioner can cause a shimmering effect on screen.
Avoid use in locations where exhaust or streams of air from projector, other devices and air conditioners flow between the projector and the screen.
- The lens of projector is affected by the heat from the luminous source. Because of this, the focusing may not be stable right after the power is turned on. Focusing is stabilized after projecting image for 30 minutes and longer.

■ Do not touch the surface of the projection lens with your bare hand.

If the surface of the projection lens becomes dirty from fingerprints or anything else, this will be magnified and projected onto the screen.

■ DLP chips

- The DLP chips are precision-made. Note that in rare cases, pixels of high precision could be missing or always lit, but this is not a malfunction.
- Directing a high power laser beam onto the projection window surface can damage the DLP chips.

■ Optical components

Operating the projector in an environment with high temperature or heavy exposure to dust or tobacco smoke will reduce the service life of the optical components and may necessitate their replacement within less than one year of use. For details, consult your dealer.

■ Lamp

The luminous source of the projector is a mercury lamp with high internal pressure.
A high pressure mercury lamp has following characteristics.

- The brightness of the lamp will decrease by duration of usage.
- The lamp may burst with sound or shorten life by shock or chipping.
- The life of the lamp varies greatly depending on individual specificities and usage conditions. In particular, continuous use over 22 hours and frequent on/off switching of the power greatly deteriorate the lamp and affect the lamp life.
- In rare cases, the lamp burst shortly after the projection.
- The risk of bursting increases when the lamp is used beyond its replacement cycle. Make sure to replace the lamp unit consistently. (➡ page 56)
- If the lamp bursts, gas contained inside of the lamp is released in a form of smoke.
- It is recommended to store replacement lamps for contingency.
- It is recommended to have authorized engineer or your dealer replace the lamp unit.



■ About connections to computer or peripheral device

To assure continued compliance, follow the attached installation instructions, which include using the provided power cord and shielded interface cables when connecting to computer or peripheral device.

Importer's name and address within the European Union
Panasonic Marketing Europe GmbH
Panasonic Testing Center
Winsbergring 15, 22525 Hamburg, Germany

Accessories

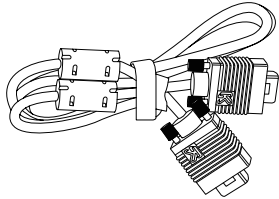
Make sure the following accessories are provided with your projector. Numbers in the brackets () show the number of accessories.

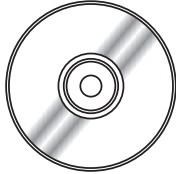
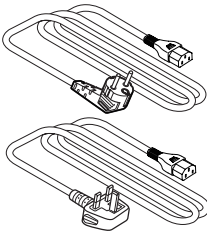
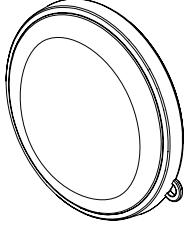
<p>Wireless remote control unit (x1) (H458UB01G001)</p>	<p>Computer cable (x1) (H4200200G105)</p>	<p>Lithium coin cell Battery CR2025 (x1)</p>	<p>CD-ROM (x1) (H368VY01G002)</p>
		 (Included to the remote control unit at the time of purchase.)	
<p>AC Power Cord (x2) (H4200110G011) (H4200120G011)</p>	<p>Lens cap (x1) (H758VY03G001)</p>		
	 (Attached to the projector at the time of purchase.)		

Attention

After unpacking the projector, discard the power cord cap and packaging material properly.

- For lost accessories, consult your dealer.
- Store small parts in an appropriate manner, and keep them away from young children.
- During unpacking, the DESICCANT displayed on the projector body indicates the position of the desiccant bag. Please see notes in "Read this first!" (➡ page 7).

Note

- The model numbers of accessories are subject to change without prior notice.

Optional accessories

Options	Model No.
Replacement lamp unit	ET-LAL341 (for PT-TW330EA and PT-TX300EA) ET-LAL331 (for PT-TW240EA)
Ceiling Mount Bracket	ET-PKV100H (for high ceilings) ET-PKV100S (for low ceilings)
Projector Mount Bracket	ET-PKL300B

Note

- The model numbers of optional accessories are subject to change without prior notice.

About Your Projector

Remote control

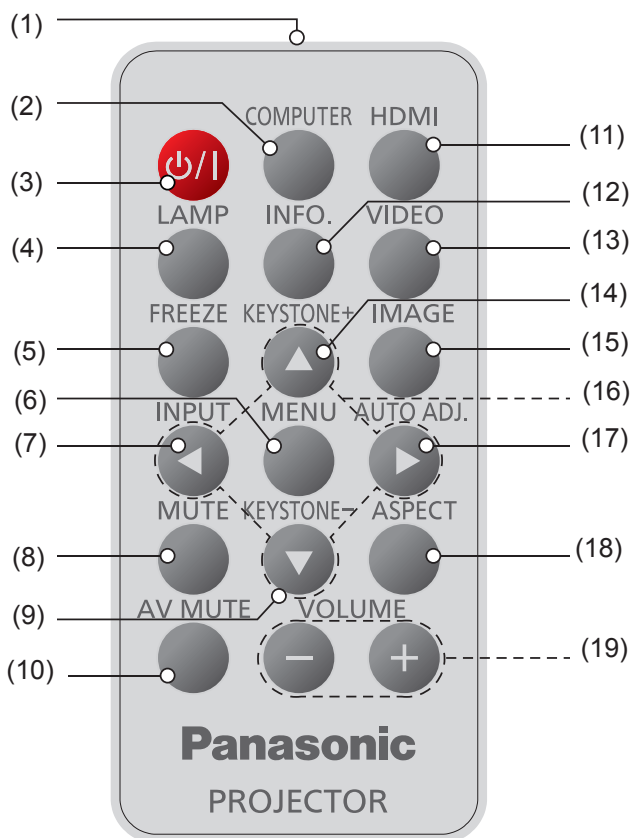

- (1) **Remote control signal emitter**
- (2) **<COMPUTER> button**
Switches COMPUTER 1 or COMPUTER 2 input. If either of the input is selected, press <COMPUTER> button will switch to the other one.
- (3) **<POWER> button**
Turns the projector on/off.
- (4) **<LAMP> button**
Displays [Lamp Power Mode] menu.
- (5) **<FREEZE> button**
Temporarily stops the image and mute the sound. Press again to return to previous state.
- (6) **<MENU> button**
Turns the main menu on/off.
- (7) **<INPUT> button**
Displays [Source] menu. (➡ page 32)
- (8) **<MUTE> button**
Temporarily mutes the sound. Press again to return to previous state.
- (9) **<KEystone -> button**
Adjusts the image to compensate for distortion caused by tilting the projector.
- (10) **<AV MUTE> button**
Momentarily turns off/on the audio and video. Press again to return to previous state.
- (11) **<HDMI> button**
Switches to HDMI source.

- (12) **<INFO.> button**
Displays [Information] menu.
- (13) **<VIDEO> button**
Switches to Video source.
- (14) **<KEystone +> button**
Adjusts the image to compensate for distortion caused by tilting the projector.
- (15) **<IMAGE> button**
Selects the color mode among Dynamic, PC, Movie, Game and User.
- (16) **▲ ▼ ◀ ▶ buttons**
Uses to operate menu.
- (17) **<AUTO ADJ.> button**
Automatically synchronize the projector to the input source.
- (18) **<ASPECT> button**
Selects [Aspect Ratio] in [Screen].
- (19) **<VOLUME +/-> buttons**
Increases/decreases speaker volume.

Attention

- Do not drop the remote control.
- Avoid contact with liquids.
- Do not attempt to modify or disassemble the remote control.

Note

- The <AUTO ADJ.> operation may not optimize the image position or the resolution, depending on the input signal format or the image contents. In this case, switch to a different image and execute <AUTO ADJ.> again.
- When pointing the remote control directly toward the projector (Remote control signal receiver), operating range for the remote control is within 8 m (26.25 ft). Also, operation range available for four directions (up, down, left, right to the projector) is ± 30° and the operation distance may become short.
- If there are any obstacles between the remote control and the remote control signal receiver, the remote control may not operate correctly.
- You can operate the projector by reflecting the remote control signal on the screen. The operating range may differ due to the loss of light caused by the properties of the screen.
- When the remote control signal receiver is lit with a fluorescent light or other strong light source, the projector may become inoperative. Set the projector as far from the luminous source as possible.
- You can operate all of the functions of the projector via the remote control. Make sure not to lose the remote control.
- Before using the remote control for the first time, remove the transparent insulation sheet.

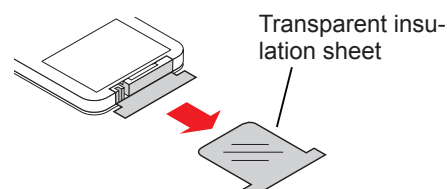

Projector body

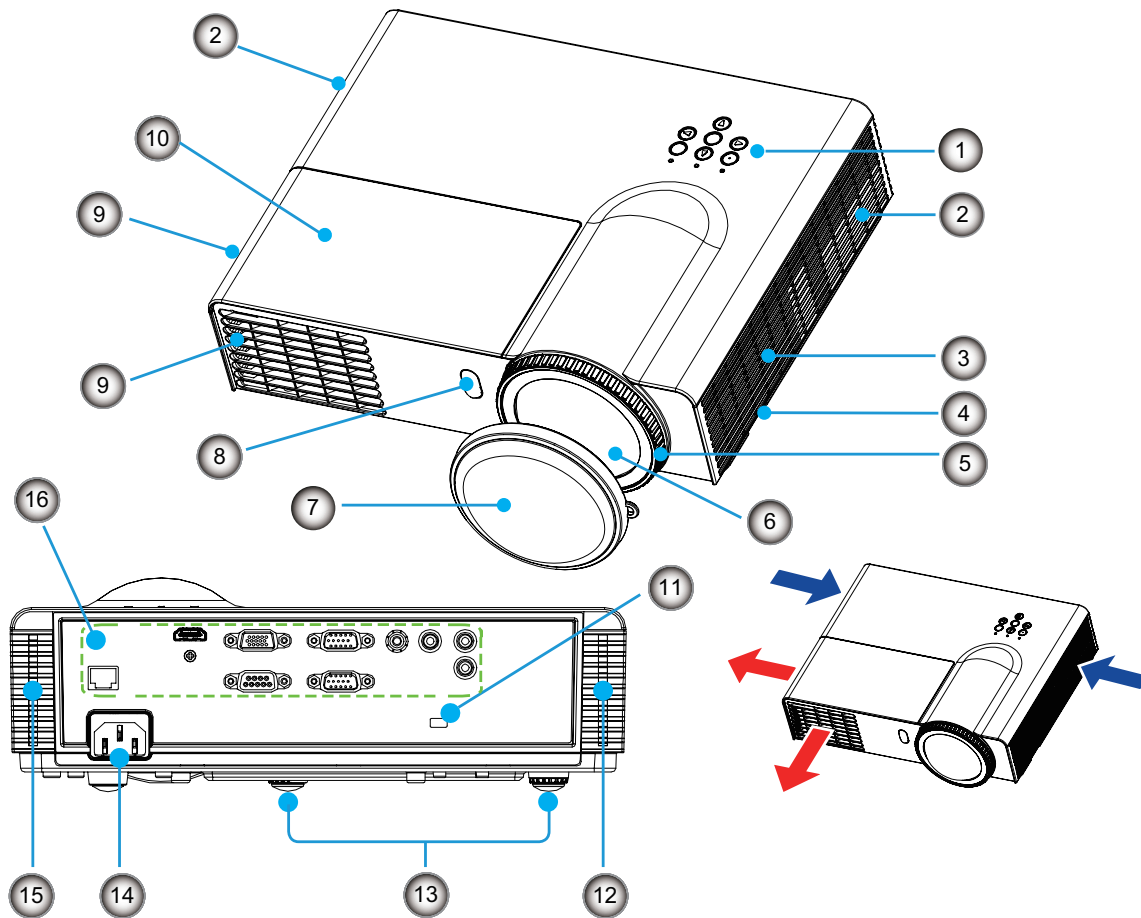

(1) Control panel and indicators (➔ page 18)

(2) Air intake port

(3) Speaker

(4) Security bar

(5) Focus ring
Adjusts the focus.

(6) Projection lens

(7) Lens cap

(8) Remote control signal receiver

(9) Air exhaust port

(10) Lamp cover(➔ page 57)

(11) Security slot

Attaches the commercial shackle lock, manufactured by Kensington, to protect your projector. Compatible with the Kensington MicroSaver Security System.

(12) Air filter (right side) (➔ pages 53, 55)

(13) Adjustable feet
Adjusts the projection angle.

(14) <AC IN> terminal

(15) Air filter (left side) (➔ pages 53, 55)

(16) Connecting terminals (➔ page 19)

WARNING:

■ Keep your hands and other objects away from the air exhaust port.

- Keep your hand and face away.
- Do not insert your finger.
- Keep heat-sensitive articles away.

Heated air from the air exhaust port can cause burns or external damage.

About Your Projector

Control Panel and Indicators

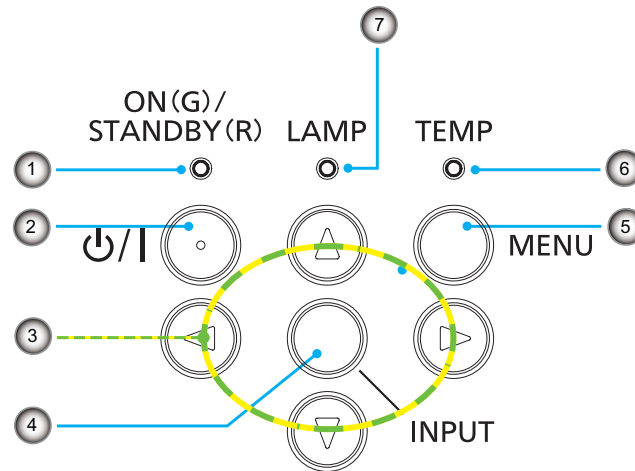

(1) <ON(G) / STANDBY(R)> indicator

Indicates the projector's status.

(2) <P> button

Turns the projector on/off.

(3) ▲▼◀▶ buttons

Uses to operate menu.

(4) <INPUT> button

Displays [Source] menu. (➔ page 32)

(5) <MENU> button

Turns the main menu on/off.

(6) <TEMP> indicator

Indicates the status of the internal temperature or the cooling fan of the projector.

(7) <LAMP> indicator

Indicates the projector's lamp status.

Connecting terminals

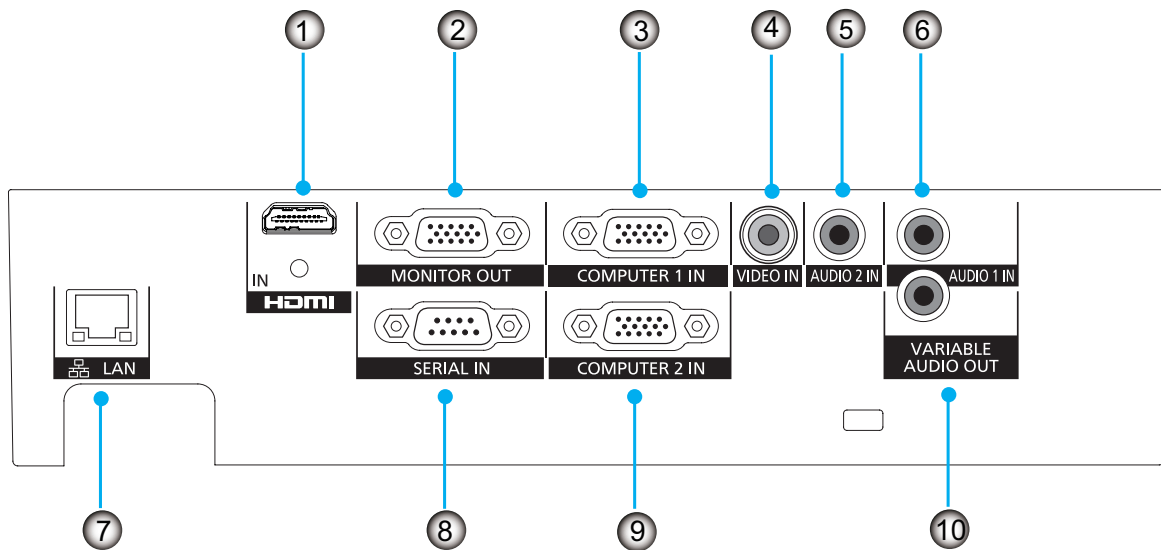

(1) <HDMI IN>

This is a terminal to connect to HDMI signal.

(2) <MONITOR OUT>

This is a terminal to output the RGB signal or YC_BC_R/YP_BP_R signal via <COMPUTER 1 IN> or <COMPUTER 2 IN> terminal.

(3) <COMPUTER 1 IN>

This is a terminal to input the RGB signal or YC_BC_R/YP_BP_R signal.

(4) <VIDEO IN>

This is a terminal to input the video signal.

(5) <AUDIO 2 IN>

This is a terminal to input the audio signal from the video equipment connected to the <VIDEO IN> terminal.

(6) <AUDIO 1 IN>

This is a terminal to input the audio signal from the computer connected to the <COMPUTER 1 IN> or <COMPUTER 2 IN> terminal.

(7) <LAN>

This is a terminal to connect to the network.

(8) <SERIAL IN>

This is a RS-232C compatible terminal to externally control the projector by connecting a computer.

(9) <COMPUTER 2 IN>

This is a terminal to input the RGB signal or YC_BC_R/YP_BP_R signal.

(10) <VARIABLE AUDIO OUT>

This is a terminal to output the audio signal input to the projector.

Attention

- When a LAN cable is directly connected to the projector, the network connection must be made indoors.

Note

- When the <HDMI IN> terminal is connected to a computer via a HDMI-DVI conversion cable, it can only input video signal and the analog audio signal can not be input.

Using Remote control

Installing and Removing battery

1) Press the guide and pull out the battery base.

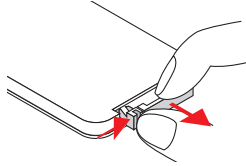

2) Install new battery into the compartment.



Remove the old Lithium coin cell battery and install new one (CR2025). Ensure that the side with a "+" is facing up.

3) Put the battery base back.

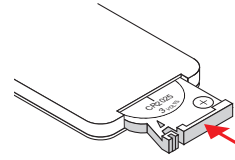

Attention

- When discarding a lithium coin battery, be sure both sides (+/-) are covered with adhesive insulating tape, such as and the cellophane tape, and discard it according to the instructions of the local government.

Setting Remote control ID numbers

When you use the system with multiple projectors, you can operate all the projectors simultaneously or each projector individually using single remote control, if unique ID number is assigned to each projector. After setting the remote control ID of the projector, set the same remote control ID to the remote control. There are 7 different remote control IDs: [All], [ID1]~[ID6], the initial remote control ID is [All].

■ Setting the remote control ID

- 1) While holding down the <MENU> key, press the <IMAGE> key. The number of times you press the <IMAGE> key corresponds to the desired remote control ID.
The number of times to press the <IMAGE> key is as follows:
ID1 = Once, ID2 = Twice, ID3 = 3 times, ID4 = 4 times, ID5 = 5 times, ID6 = 6 times.
- 2) The remote control ID is changed when the <MENU> button is released.

■ Resetting the remote control ID

The remote control ID is reset to [All] (default) by pressing the <MENU> key and <IMAGE> key at the same time for 10 seconds or more.

Note

- When operating the projector under [All] code, you can operate several projectors at the same time.
- If the <IMAGE> button is pressed 7 times or more, the remote control ID cannot be changed (the operation is invalid).
- For setting the remote control ID codes, see [Remote ID] in the [Setting] menu. (➡ page 41)
- If the battery is not in use for a long period of time and is removed from the remote control, the remote control ID will be reset.

Setting up

Projection method

You can use the projector with any of the following 4 projection methods to set the desired method in the projector.

■ Setting on a desk/floor and projecting forward

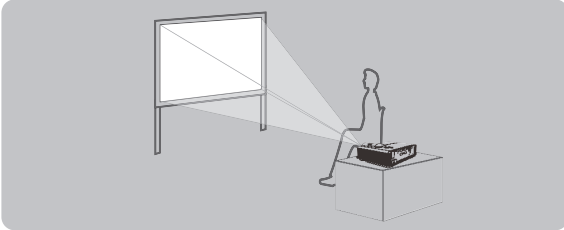

Menu setting*1

[Ceiling Mount] [Front]

■ Mounting on the ceiling and projecting forward

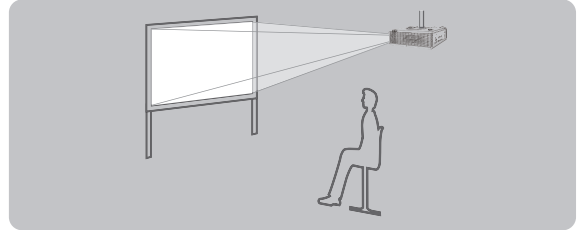

Menu setting*1

[Ceiling Mount] [Front Ceiling]

■ Mounting on the ceiling and projecting from rear

(Using translucent screen)

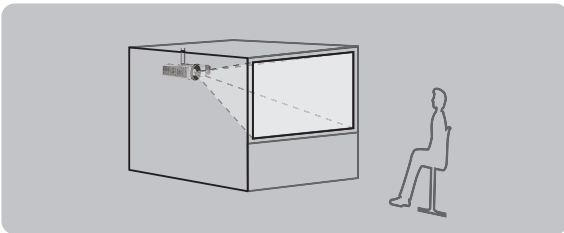

Menu setting*1

[Ceiling Mount] [Rear Ceiling]

■ Setting on a desk/floor and projecting from rear

(Using translucent screen)

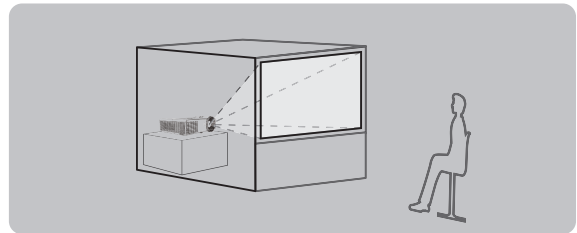

Menu setting*1

[Ceiling Mount] [Rear]

*1 : For details about the menu setting, please refer to the [Position] menu → [Ceiling Mount]. (➡ page 39)

Parts for ceiling mount (Optional)

You can install the projector on the ceiling by using the optional ceiling mount bracket (ET-PKV100H: for high ceiling, ET-PKV100S: for low ceiling), the optional projector mount bracket ET-PKL300B.

- Use only the ceiling mount brackets specified for this projector.
- Refer to the installation instructions for the ceiling mount bracket when you install the bracket or hanger and the projector.

Attention

- To ensure projector performance and security, installation of the ceiling mount bracket must be carried by your dealer or a qualified technician.

Setting up

Screen size and throw distance

Place the projector referring to the diagram on the right and the figures of throwing distance. You can adjust the display size.

Attention

- Before installing, please read "Precautions for Use". (➔ pages 12 to 15)
- Do not use the projector and the high-powered laser equipment in the same room. Hitting of a laser beam on to the lens can damage the DLP chips.

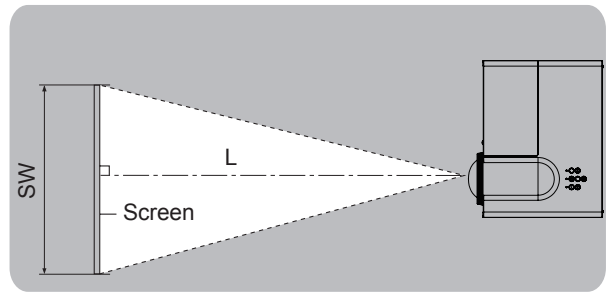
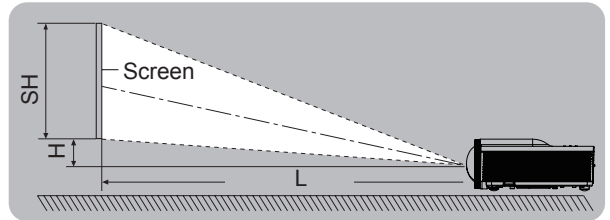
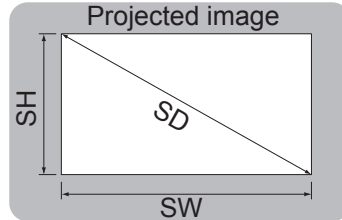

L	Projection distance (m)
SH	Height of the projection area (m)
SW	Width of the projection area (m)
H	Distance from the center of lens to the image lower end (m)
SD	Diagonal length of the projection area (m)

■ Projection distance for PT-TW330EA and PT-TW240EA

All measurements below are approximate and may differ slightly from the actual measurements. (Unit: m)

Projection size Screen diagonal (SD)	For 4:3 aspect ratio		For 16:9 aspect ratio		For 16:10 aspect ratio	
	Projection distance (L)	Height position (H)	Projection distance (L)	Height position (H)	Projection distance (L)	Height position (H)
1.27 (50")	0.64	0.09	0.58	0.12	0.56	0.08
1.52 (60")	0.76	0.11	0.69	0.14	0.67	0.10
1.78 (70")	0.89	0.13	0.81	0.17	0.79	0.12
2.03 (80")	1.02	0.15	0.92	0.19	0.90	0.13
2.29 (90")	1.14	0.17	1.04	0.22	1.01	0.15
2.54 (100")	1.27	0.19	1.15	0.24	1.12	0.17
3.05 (120")	1.52	0.23	1.38	0.29	1.35	0.20
3.81 (150")	1.91	0.28	1.73	0.36	1.68	0.25
5.08 (200")	2.54	0.38	2.31	0.48	2.25	0.33

● Calculation formulas for projection distance

Any other projection distance can be obtained according to the screen dimensions (m) using the following calculations. The calculation result is with the "m" unit. (The calculated distance below may contain a certain error.) If the screen dimensions are written as "SD",

	For 4:3 aspect ratio	For 16:9 aspect ratio	For 16:10 aspect ratio
Screen height (SH)	= SD × 0.6	= SD × 0.490	= SD × 0.530
Screen width (SW)	= SD × 0.8	= SD × 0.872	= SD × 0.848
Projection distance (L)	= 0.500 × SD	= 0.454 × SD	= 0.442 × SD

Note

- The throw ratio is 0.52:1 when the projection size is 100 inch.

■ Projection distance for PT-TX300EA

All measurements below are approximate and may differ slightly from the actual measurements. (Unit: m)

Projection size	For 4:3 aspect ratio		For 16:9 aspect ratio	
	Projection distance (L)	Height position (H)	Projection distance (L)	Height position (H)
1.02 (40")	0.51	0.09	-	-
1.27 (50")	0.64	0.11	0.69	0.23
1.52 (60")	0.76	0.14	0.83	0.27
1.78 (70")	0.89	0.16	0.97	0.32
2.03 (80")	1.02	0.18	1.11	0.37
2.29 (90")	1.14	0.21	1.25	0.41
2.54 (100")	1.27	0.23	1.39	0.46
3.05 (120")	1.53	0.27	1.66	0.55
3.81 (150")	1.91	0.34	2.08	0.68
5.08 (200")	2.54	0.46	-	-

● Calculation formulas for projection distance

Any other projection distance can be obtained according to the screen dimensions (m) using the following calculations. The calculation result is with the "m" unit. (The calculated distance below may contain a certain error.) If the screen dimensions are written as "SD",

	For 4:3 aspect ratio	For 16:9 aspect ratio
Screen height (SH)	= SD × 0.6	= SD × 0.490
Screen width (SW)	= SD × 0.8	= SD × 0.872
Projection distance (L)	= 0.5008 × SD	= 0.5456 × SD

Note

- The throw ratio is 0.63:1 when the projection size is 100 inch.

Adjusting the Projector's Height

The projector is equipped with elevator feet for adjusting the image height. Extend the adjustable feet by rotating in the direction shown in the below picture and retract by rotating in the opposite direction.

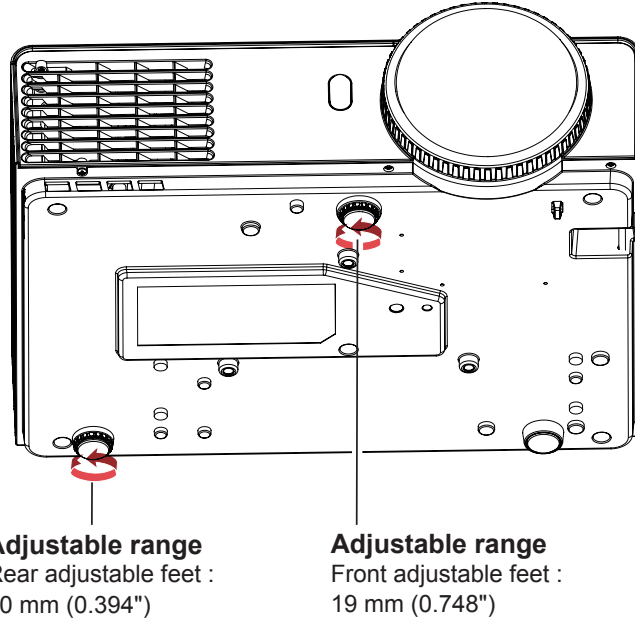

The rear adjustable feet stretch to its end

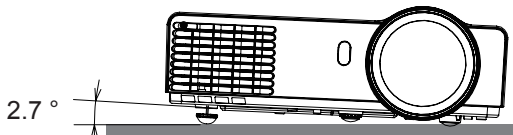

The front adjustable feet stretch to its end

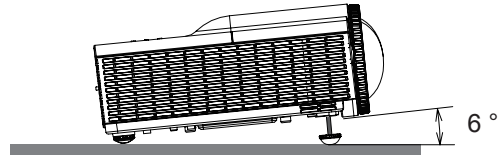

Attention

- It is very hot around the lamp and the air exhaust port when the lamp is lighting and for a while after the lamp is turned off. And, hot air is expelled from the air exhaust port when the lamp is lighting. Do not touch there directly when adjusting the adjustable feet.
- Do not stretch the adjustable feet more than the above mentioned length. Otherwise, the projector may be unstable or the adjustable feet may fall off.

Connections

Before connecting to the projector

- Read carefully the instruction manual for the device to be connected.
- Turn off the power switch of the devices before connecting cables.
- If any connection cable is not supplied with the device, or if no optional cable is available for connection of the device, prepare a necessary system connection cable to suit the device.
- Video signals containing too much jitter may cause the images on the screen to randomly wobble or wafture. In this case, a time base corrector (TBC) must be connected.
- The projector accepts the following signals: VIDEO, analogue-RGB (with TTL sync. Level) and digital signal.
- Some computer models are not compatible with the projector.
- When using long cables to connect with each of equipment to the projector, there is a possibility that the image will not be output correctly unless a compensator is used.
- For details on what video signals the projector supports, see “List of compatible signals”. (► pages 66-67)

Attention

- When connecting with a video deck, be sure to use the one with a built-in time base corrector (TBC) or use a TBC between the projector and the video deck.
- If nonstandard burst signals are connected, the image may be distorted. If this is the case, connect a TBC between the projector and the video deck.

Note

- Use an HDMI cable that conforms to HDMI standards such as an HDMI High Speed cable. If a cable that does not meet HDMI standards is used, video may be interrupted or may not be displayed.
When connecting the 1080p signal using HDMI, use a cable compliant with 1080p signal.
- This projector does not support the VIERA Link (HDMI).

Connections

Connecting example: Computers

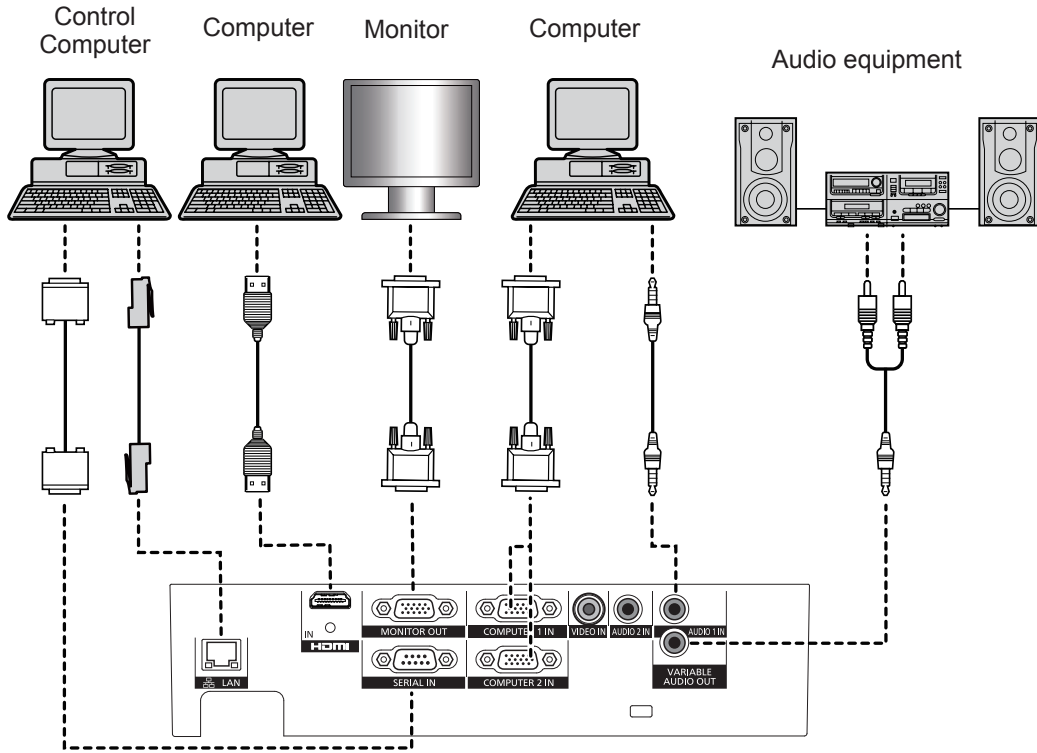

Connecting example: AV equipment

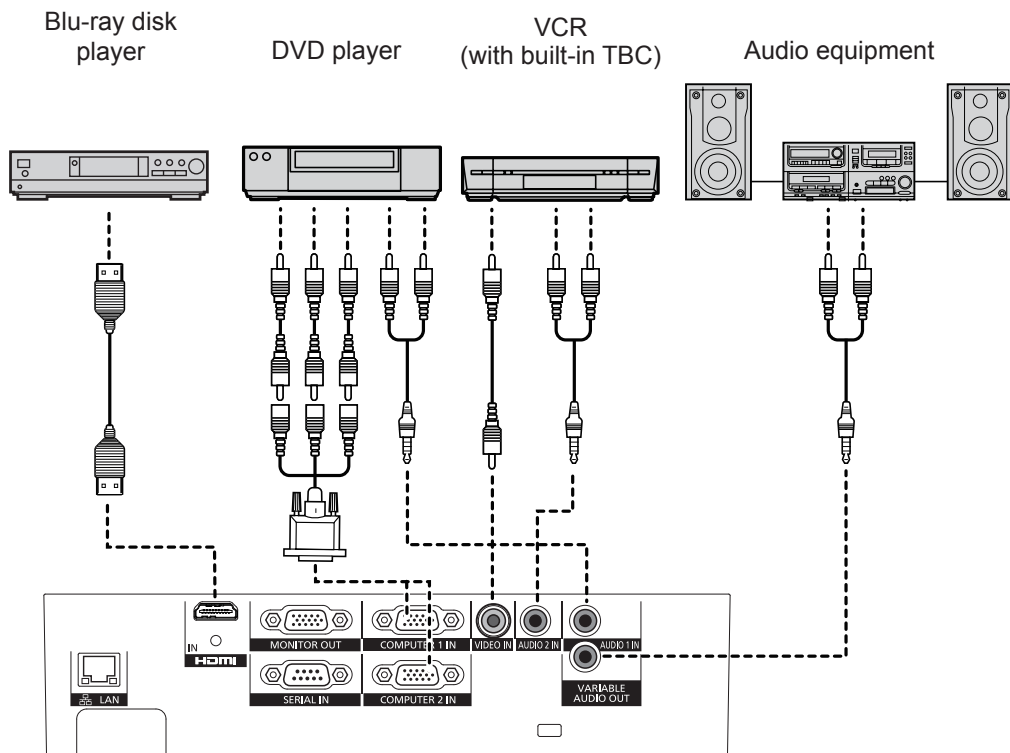

Powering ON/OFF

Connecting the power cord

Use the supplied power cord to prevent removal of the power cord and make sure that it is fully inserted into the projector.

For detailed power cord handling, refer to "Read this first!" (► pages 2 to 8).

■ Attaching

- 1) Check the shapes of the <AC IN> terminal on the back side of the projector and the power cord connector and fully insert.
- 2) Connect the power plug to an outlet.

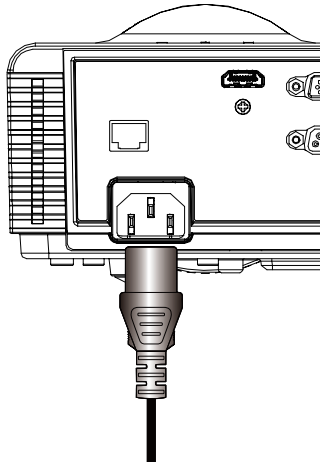

■ Removing

- 1) Confirm that the projector is in standby mode and unplug the power cord from the outlet.
- 2) Remove the plug from the <AC IN> terminal.

Powering ON/OFF

ON(G)/STANDBY(R) indicator

The ON(G)/STANDBY(R) indicator informs you the status of the power. Confirm the status of the <ON(G)/STANDBY(R)> indicator before operating the projector.

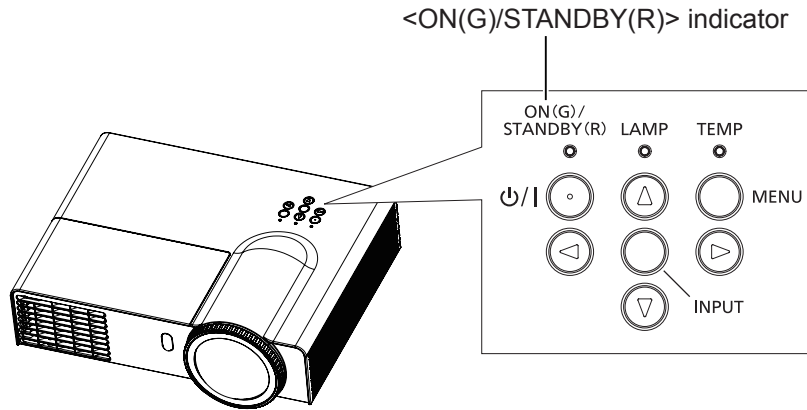

Indicator status		Status
No illumination		The power plug is not connected to the outlet.
Red	Lit*1	The power is switched off. (Standby mode) Press <power> to start projection.
	Slow Blinking*2	The power is switched off. (Standby mode) Press <power> to start projection.
	Blinking	The projector is preparing to switch off the power. The power is switched off after a while. (Changes to the standby mode.)
Green	Lit	The projector is in the projection status.
	Blinking	The projector is preparing for projection.

*1: When [LAN (Standby)], [VGA Out (Standby)], [In Standby Mode (Audio)] are all set to [Off].

*2: When one or more among [LAN (Standby)]/[VGA Out (Standby)]/[In Standby Mode (Audio)] is/are set to [On].

Note

- When the <ON(G)/STANDBY(R)> indicator is blinking in red, the internal fans start to operate and the projector starts cooling.

Powering On the Projector

Before switching on the projector, make sure all the other devices are correctly connected (➔ page 26) and remove the lens cap.

1) Connect the power plug to the power outlet.

- Enter Standby status when the <ON(G)/STANDBY(R)> indicator is lighting / blinking in red.

2) Press the <⏻/|> button on the control panel or the remote control.

- When the <ON(G)/STANDBY(R)> indicator lights up in green, the lamp is on.
- Startup screen is displayed for about 10 seconds, then the image will be projected.

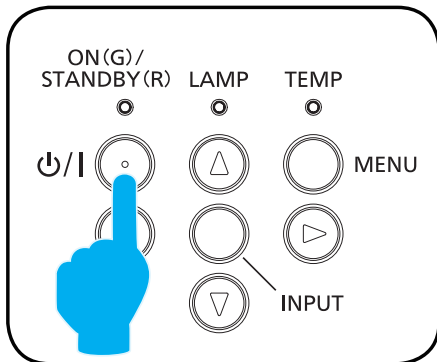

OR

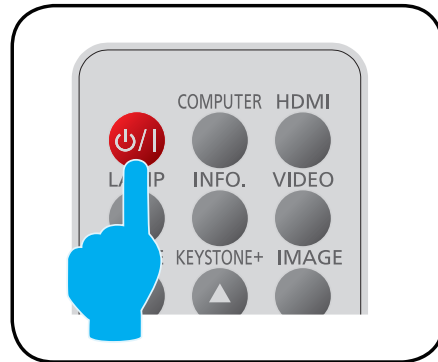

Note

- If the power is disconnected due to the power breaker during projection at the last use, the <ON(G)/STANDBY(R)> indicator will light in green automatically at the next startup and the image will be projected.

Powering Off the Projector

1) Press the <⏻/|> button on the control panel or the remote control.

- The following message appears.
- Message will disappear after about 30 seconds when there is no operation.

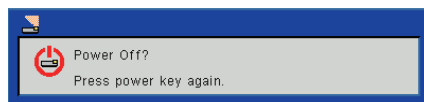

2) Press the <⏻/|> button again.

- The projection stops and the <ON(G)/STANDBY(R)> indicator on the projector flashes up in red. (Fan is still spinning.)

3) Wait until the <ON(G)/STANDBY(R)> indicator lights / blinks in red (The fans stop spinning).

- The projector enters standby mode when the <ON(G)/STANDBY(R)> indicator lights / blinks in red.

Note

- Do not turn on the power and project images immediately after turning the projector off. Turning on the power while the lamp is still hot may shorten the lamp life.
- Make sure that the projector is cool enough if you want to pack it for transportation and storage.

Projecting

Check the connections of the peripheral devices and connection of the power cord (➔page 27) and switch on the power (➔page 29) to start the projector. Select the image and adjust the state of the image.

Selecting the input signal

Select an input signal.

Press **<INPUT>** button on the control panel or the **<INPUT>**, **<COMPUTER>**, **<HDMI>**, **<VIDEO>** button on the remote control.

- The image of the signal being input in the selected terminal is projected.
- Press **<INPUT>** button to display the [Source] menu. Press ▲▼ to select the desired input and press ► to enter.

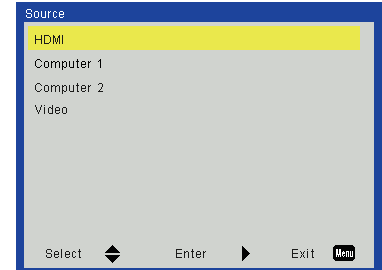

How to adjust the state of the image

1) Adjust the projection angle.

- Place the projector parallel to the screen, and then install it on a flat surface so that the screen becomes rectangle.
- If the image is tilted lower than the screen, extend the adjustable feet to make a rectangle screen.
- For details, see “Adjusting the Projector’s Height” (➔page 24).

2) Adjust the focus.

Turn the focus ring to adjust the image.

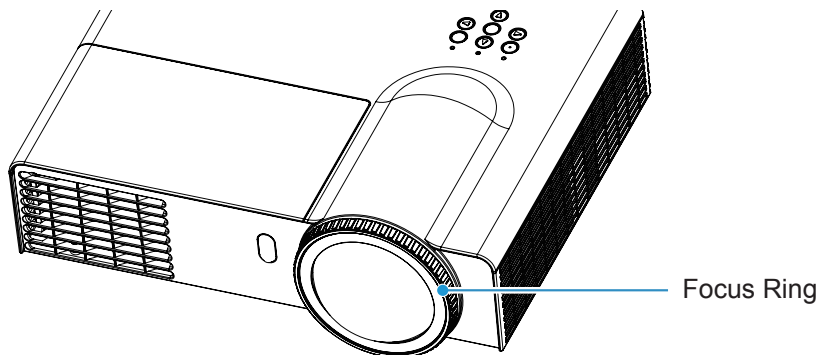

Note

- It is recommended that the images are projected continuously for at least 30 minutes before the focus is adjusted.
- If keystone distortion occurs, see [V Keystone] in the [Position] menu (➔page 39).

Basic operations by using the remote control



Switching the input signal

Press this button to switch input signals.

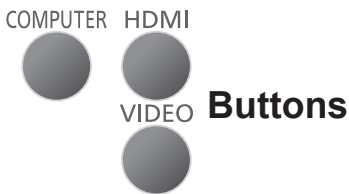

Press (<COMPUTER>, <HDMI>, <VIDEO>) button on the remote control.

COMPUTER	Switches to Computer 1/ Computer 2 input.
HDMI	Switches to HDMI input.
VIDEO	Switches to Video input.

Note

- For details, see "Selecting the input signal". (➔page 30)

<LAMP> button

Press this button to display the [Lamp Power Mode] menu.



Press the <LAMP> button on the remote control.

Note

- For details, see "Lamp Power Mode". (➔page 44)

<INFO.> button

Press this button to display the [Information] menu.



Press the <INFO.> button on the remote control.

Note

- For details, see "Information". (➔page 44)

<FREEZE> button

This function allows you to temporarily freeze the picture on the screen of the external devices, meanwhile, volume is muted.



Press the <FREEZE> button on the remote control.

- Fig.1 will appear on the screen while the Freeze function is working.



Fig.1

Note

- To cancel the Freeze function, press the <FREEZE> button again.

<KEYSTONE> buttons

This function allows you to correct keystone distortion.

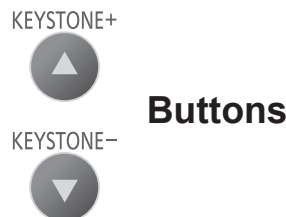

Press the <KEYSTONE+> or <KEYSTONE-> button on the remote control.

Note

- For details, see [V Keystone] in the [Position] menu. (➔page 39)

Basic operations by using the remote control

<IMAGE> button

Press this button to display the picture mode menu and to change the settings of the image.

IMAGE



Button

Press the <IMAGE> button on the remote control.

Note

- For details, see [Color Mode] menu of [Picture] menu. (➔page 36)

<INPUT> button

Press this button to display the [Input] menu and to switch to the desired input signal.

INPUT



Button

Press the <INPUT> button on the remote control.

Note

- For details, see “Selecting the input signal”. (➔page 30)

<MENU> button

Press this button to display the main menu and to return to the main menu from the submenu.

MENU



Button

Press the <MENU> button on the remote control.

Note

- For details, see “On-screen Display Menus”. (➔page 33)

<AUTO ADJ.> button

Press this button to optimize to the best image quality during the computer input signal.

AUTO ADJ.



Button

Press the <AUTO ADJ.> button on the remote control.

Note

- The <AUTO ADJ.> operation may not optimize the image position or the resolution, depending on the input signal format or the image contents. In this case, switch to a different image and execute <AUTO ADJ.> again.

<MUTE> button

Press this button to temporarily turn off the sound.

MUTE



Button

Press the <MUTE> button on the remote control.

Note

- To turn the sound back on, press the <MUTE> button again or press the <VOLUME +/-> buttons. (➔page 42)

<ASPECT> button

Press this button to display the [Position] menu and to change the aspect settings.

ASPECT



Button

Press the <ASPECT> button on the remote control.

Note

- For details, see [Aspect Ratio] of [Screen] menu. (➔page 38)

<AV MUTE> button

Press this button to temporarily black out the image and turn off the sound.

AV MUTE



Button

Press the <AV MUTE> button on the remote control.

Note

- Press the <AV MUTE> button again to cancel.

<VOLUME> buttons

Press the buttons to display [Volume] menu and to adjust the volume of the build-in speaker.

VOLUME



Buttons

Press the <VOLUME+/-> buttons on the remote control.

Note

- For details, see [Volume] of [Audio] menu. (➔page 42)

On-screen Display Menus

How to operate menu

■ Operation steps

- 1) Press <MENU> button on the remote control or on the control panel.
 - Main Menu displays.
- 2) Use ▲▼ to select any item in the Main Menu.
 - The selected item is highlighted in orange.
- 3) Press ►.
 - Items in the Sub Menu can be selected.
- 4) Use ▲▼ to select any item in the Sub Menu.
 - The selected item is highlighted in yellow.
- 5) Press ► to display adjusting box.
- 6) Use ▲▼ to switch or adjust all settings.
- 7) Press <MENU> button to go back to the Sub Menu and press again to go back to the Main Menu, press <MENU> button once more to close the Main Menu.

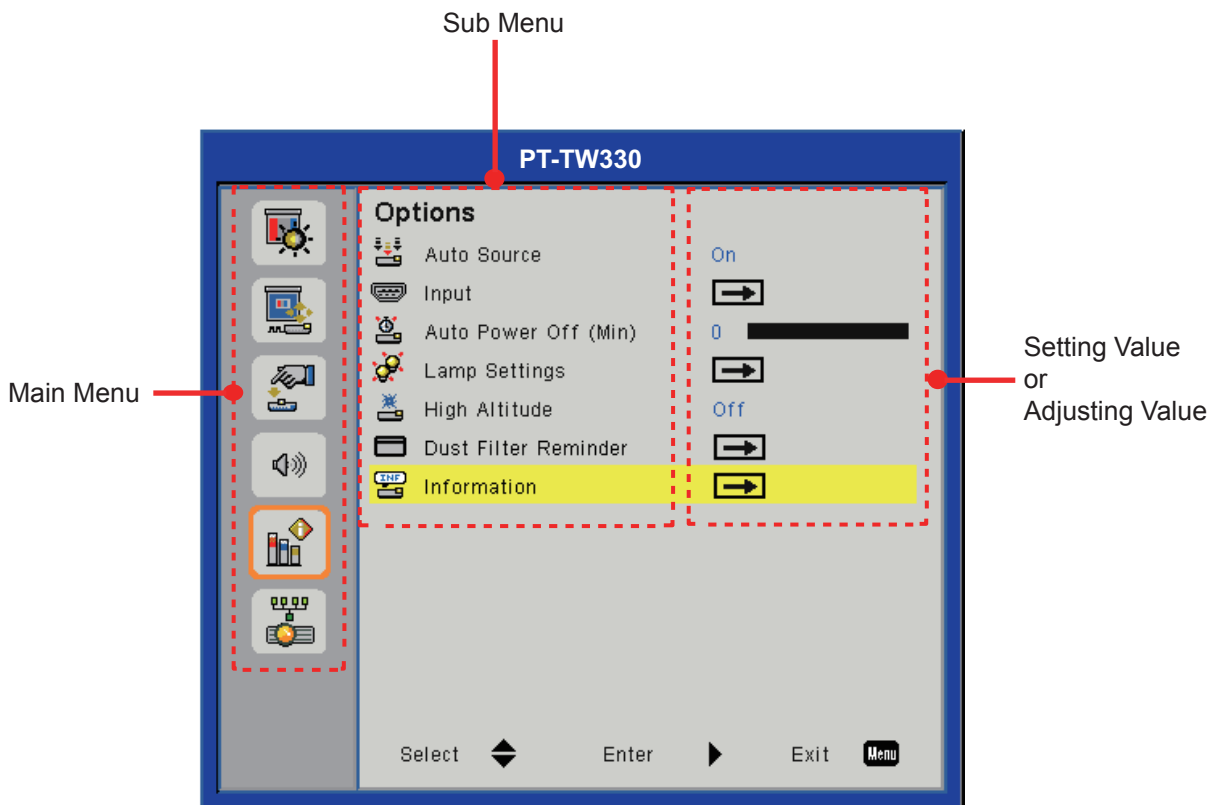

Note

- Some items may not be adjusted or used for certain signal formats input to the projector. The MENU items that cannot be adjusted or used are shown in gray characters, and they cannot be selected.
- Some items can be adjusted even if signals are not input.
- If there is no operation to the projector for about 30 seconds, the Menu screen and the adjusting screen will disappear automatically.
- See pages 34 and 35 for details on the items of Sub Menu.

On-screen Display Menus

Menu Tree

Main Menu	Sub Menu	2nd Sub Menu	Default Value	Range
Picture	Color Mode	Dynamic / PC / Movie / Game / User		
	Wall color	White / Light Yellow / Light Blue / Pink / Dark Green	White	
	Brightness			0 ~ 100
	Contrast			0 ~ 100
	Sharpness			0 ~ 31
	Saturation			0 ~ 100
	Hue			0 ~ 100
	Gamma			0 ~ +3
	Color Temp.	Low / Mid / High		
	Color Space	Auto / RGB / YUV	Auto	
Position	Aspect Ratio	Auto / 4:3 / 16:9 / 16:10	Auto	
	Phase			0 ~ 31
	Clock			-5 ~ 5
	H. Position			
	V. Position			
	Digital Zoom		0	0 ~ 10
	V Keystone		0	-40 ~ 40
Ceiling Mount	Front / Front Ceiling / Rear / Rear Ceiling	Front		
Setting	Language	English / German / Spanish / French / Italian / Dutch / Portuguese / Japanese / Simplified Chinese / Polish / Korean / Russian / Swedish / Traditional Chinese/Arabic / Norwegian / Turkish / Thai / Czech / Hungarian / Kazakh	English	
	Menu Location	Left Top / Right Top / Center / Left Bottom / Right Bottom	Center	
	Closed Caption	Off / CC1 / CC2 / CC3 / CC4	Off	
	VGA Out (Standby)	On / Off	Off	
	Test Pattern	On / Off	Off	
	Remote ID	All / ID1 / ID2 / ID3 / ID4 / ID5 / ID6	All	
	Startup Logo	On / Off	On	
	UART Mode	LAN / RS-232	LAN	
	LAN (Standby)	On / Off	Off	
Reset	Yes / No	No		
Audio	Mute	On / Off	Off	
	Volume		20	0 ~ 32
	In Standby Mode (Audio)	On / Off	Off	

On-screen Display Menus

Main Menu	Sub Menu	2nd Sub Menu	Default Value	Range	
Options	Auto Source	On / Off	On		
	Input	HDMI, Computer 1, Computer 2, Video			
	Auto Power Off (Min)		0	0~120	
	Lamp Settings	Lamp Hours Used (Normal)		0	
		Lamp Hours Used (ECO)		0	
		Lamp Life Reminder	Off/On	On	
		Lamp Power Mode	Normal / Auto / ECO1 / ECO2 for PT-TW330EA / PT-TX300EA. Normal / Auto / ECO for PT-TW240EA.	Normal	
		Clear Lamp Hours	Yes / No	No	
	High Altitude	On / Off	Off		
	Dust Filter Reminder	Filters Remind (Hour)		0	0 ~ 1000
		Cleaning up reminder	Yes / No	No	
	Information	Model Name			
		Source			
		Resolution			
Software Version					
Color Space					
Aspect Ration					
LAN	DHCP	On / Off	Off		
	IP Address		192.168.10.100		
	Subnet Mask		255.255.255.0		
	Gateway		192.168.10.1		
	DNS		0.0.0.0		
	Store	Yes / No			
	Reset	Yes / No			

Note

- Please note that the on-screen display (OSD) menus vary according to the signal type selected and the projector model you are using.
- [Sharpness], [Saturation] and [Hue] are only supported in Video mode.

Picture

Select [Picture] from the Main Menu (see “How to operate menu” on page 33) and then select the item from the Sub Menu.

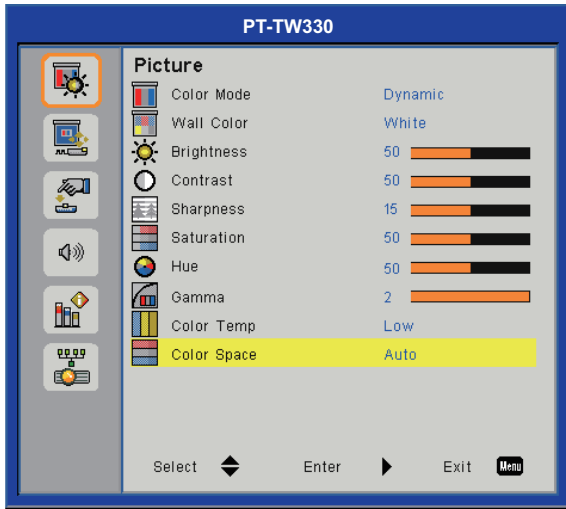

Color Mode

There are many factory presets optimized for various types of images.

- 1) Press ▲ ▼ to select [Color Mode].
- 2) Press ► to display the choosing dialog box.
- 3) Press ◀▶ to select the desired item.

Dynamic	For bright room.
PC	For computer or notebook.
Movie	For home theater.
Game	For amusing games.
User	For user's favorite image mode.

Note

- When [Dynamic], [PC], [Movie] or [Game] is selected, the value of [Brightness], [Contrast], [Sharpness], [Saturation], [Hue], [Gamma], [Color Temp] will be fixed.
- When [Brightness], [Contrast], [Sharpness], [Saturation], [Hue], [Gamma], [Color Temp] is adjusted, [Color Mode] will change to [User].
- The value of [User] depends on the type of the input signal.
Video, 480i/576i, 480p/576p, 720p, 1080i, 1080p, RGB, HDMI (YUV), HDMI (RGB).

Wall color

Select an appropriate color for wall projection.

- 1) Press ▲ ▼ to select [Wall color].
- 2) Press ► to display the choosing dialog box.

- 3) Press ◀▶ to select the desired item.

White	For White color.
Light Yellow	For Light Yellow color.
Light Blue	For Light Blue color.
Pink	For Pink color.
Dark Green	For Dark Green color.

Note

- [Wall Color] does not support movie-based video signals.

Brightness

You can adjust the dark (black) part of the projected image.

- 1) Press ▲ ▼ to select [Brightness].
- 2) Press ► to display the adjustment dialog box.
- 3) Press ◀▶ to adjust the setting value.

Operation	Adjustment	Adjustment range
Press ►.	Increases the brightness of the dark (black) parts of the screen.	Maximum value 100
Press ◀.	Reduces the brightness of the dark (black) parts of the screen.	Minimum value 0

Contrast

You can adjust the contrast of the colors.

- 1) Press ▲ ▼ to select [Contrast].
- 2) Press ► to display the adjustment dialog box.
- 3) Press ◀▶ to adjust the setting value.

Operation	Adjustment	Adjustment range
Press ►.	Brightens the screen and makes the color of image deeper.	Maximum value 100
Press ◀.	Darkens the screen and makes the color of image lighter.	Minimum value 0

Sharpness

You can adjust the sharpness of the projected image.

- 1) Press ▲ ▼ to select [Sharpness].

- 2) Press ► to display the adjustment dialog box.
- 3) Press ◀► to adjust the setting value.

Operation	Adjustment	Adjustment range
Press ►.	Contours become sharper.	Maximum value 31
Press ◀.	Contours become softer.	Minimum value 0

Note

- During Video input signal, [Sharpness] can be adjusted.
- When [RGB] is selected at [Color Space] menu, [Sharpness] is disable.

Saturation

Adjust a video image from black and white to fully saturated color.

- 1) Press ▲▼ to select [Saturation].
- 2) Press ► to display the adjustment dialog box.
- 3) Press ◀► to adjust the setting value.

Operation	Adjustment	Adjustment range
Press ►.	Increase the intensity of the color.	Maximum value 100
Press ◀.	Decrease the intensity of the color.	Minimum value 0

Note

- During Video input signal, [Saturation] can be adjusted.
- When [RGB] is selected at [Color Space] menu, [Saturation] is disable.

Hue

Adjust the skin tone.

- 1) Press ▲▼ to select [Hue].
- 2) Press ► to display the adjustment dialog box.
- 3) Press ◀► to adjust the setting value.

Operation	Adjustment	Adjustment range
Press ►.	Adjust the skin tone to be green.	Maximum value 100
Press ◀.	Adjust the skin tone to be red.	Minimum value 0

Note

- During Video input signal and when the color mode is NTSC or NTSC 4.43, [Hue] can be adjusted.
- When [RGB] is selected at [Color Space] menu, [Hue] is disable.

Gamma

Adjust the gamma table when the dark areas or bright areas of the image is not clear.

- 1) Press ▲▼ to select [Gamma].
- 2) Press ► to display the adjustment dialog box.
- 3) Press ◀► to adjust the setting value.

Operation	Adjustment	Adjustment range
Press ►.	Emphasize detail in dark areas of image.	Maximum value +3
Press ◀.	Emphasize detail in bright areas of image.	Minimum value 0

Color Temp

Select the color temperature.

- 1) Press ▲▼ to select [Color Temp].
- 2) Press ► to display the choosing dialog box.
- 3) Press ◀► to select the desired item.

Low	The screen looks warmer.
Mid	The medium color temperature.
High	The screen looks colder.

Color Space

Select an appropriate color matrix type from Auto, RGB or YUV.

- 1) Press ▲▼ to select [Color Space].
- 2) Press ► to display the choosing dialog box.
- 3) Press ◀► to select the desired item.

Auto	Switched automatically according to the input signal.
RGB	For computer input.
YUV	For component input.

Note

- During Video input signal, [Color Space] will be in gray and can not be operated.

Position

Select [Position] from the Main Menu (see “How to operate menu” on page 33) and then select the item from the Sub Menu.

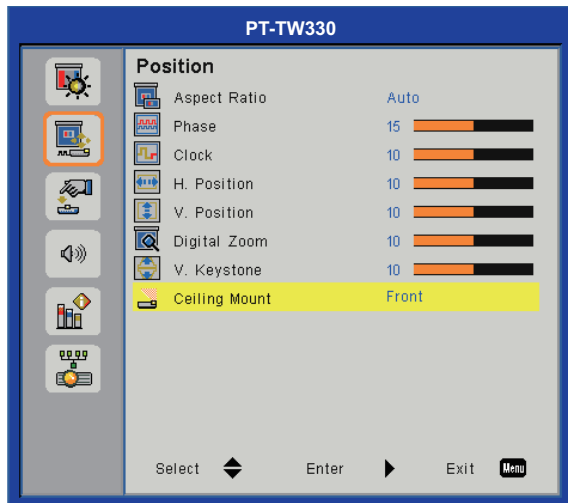

Aspect Ratio

Use this function to choose your desired aspect ratio.

- 1) Press ▲ ▼ to select [Aspect Ratio].
- 2) Press ► to display the choosing dialog box.
- 3) Press ◀ ▶ to select the desired item.

Auto	The projector identifies the video ID (VID) embedded in the image signals and displays the image by automatically switching the screen sizes between 4:3 and 16:9.
4:3	When standard signals*1 are input, the pictures are displayed without changing the aspect ratio. When wide-screen signals*2 are input, the pictures are displayed with the aspect ratio converted to 4:3.
16:9	When standard signals*1 are input, the pictures are displayed with the aspect ratio converted to 16:9. When wide-screen signals*2 are input, the pictures are displayed without changing the aspect ratio.
16:10	This format is for 16:10 input sources, like wide screen laptop.

*1: Standard signals are input signals with an aspect ratio of 4:3 or 5:4.

*2: Wide-screen signals are input signals with an aspect ratio of 16:10, 16:9, 15:9 or 15:10.

Note

- If an aspect ratio which is different from the aspect ratio for the input signals is selected, the pictures will appear differently from the originals. Be careful of this when selecting the aspect ratio.
- If using this projector in places such as cafes or hotels to display programs for a commercial purpose or for public presentation, note that adjusting the aspect ratio or using the zoom function to change the screen pictures may be an infringement of the rights of the original copyright owner for that program under copyright protection laws. Take care when using a function of the projector such as the aspect ratio adjustment, zoom function, etc.
- If conventional (normal) 4:3 pictures which are not wide-screen pictures are displayed on a wide screen, the edges of the pictures may not be visible or they may become distorted. Such pictures should be viewed as with an aspect ratio of 4:3 in the original format intended by the creator of the pictures.

Phase

Adjust to achieve an optimal image when there is a flickering image.

- 1) Press ▲ ▼ to select [Phase].
- 2) Press ► to display the adjustment dialog box.
- 3) Press ◀ ▶ to adjust the level.

Note

- During Computer input signal, [Phase] can be adjusted.

Clock

Adjust to achieve an optimal image when there is a vertical flicker in the image.

- 1) Press ▲ ▼ to select [Clock].
- 2) Press ► to display the adjustment dialog box.
- 3) Press ◀ ▶ to adjust the level.

Note

- During Computer input signal, [Clock] can be adjusted.

H Position

Shift the projected image position horizontally.

- 1) Press ▲ ▼ to select [H Position].
- 2) Press ► to display the adjustment dialog box.
- 3) Press ◀ ▶ to adjust the level.

Note

- During Computer input signal, [H Position] can be adjusted.

V Position

Shift the projected image position vertically.

- 1) Press **▲▼** to select [V Position].
- 2) Press **▶** to display the adjustment dialog box.
- 3) Press **◀▶** to adjust the level.

Note

- During Computer input signal, [V Position] can be adjusted.

Digital Zoom

Adjust the magnification of the image. Magnification can be set from 1.0x to 2.0x in 0.1 increments.

- 1) Press **▲▼** to select [Digital Zoom].
- 2) Press **▶** to display the adjustment dialog box.
- 3) Press **◀▶** to adjust the level.

Note

- When the [Digital Zoom] is in the enlarge status, exits the menu screen and the [Zoom] picture will display at the bottom left of the screen. This indicates the zoom function is in use.

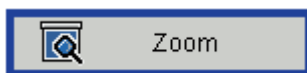

- Under the enlarge status, press **▲▼◀▶** to move the enlarged image.
- If the input signal is changed under the enlarge status, the magnification of [Digital Zoom] will be reset.

V Keystone

This function is used to adjust keystone distortion of the projected image.

- 1) Press **▲▼** to select [V Keystone].
- 2) Press **▶** to display the adjustment dialog box.
- 3) Press **◀▶** to adjust the level.
 - Use the <KEYSTONE+/-> (**▲▼**) buttons on the remote control to adjust.

Operation	Screen image
Press the ▲▶ on the remote control or the ▶ on the control panel to adjust the upper of the keystone.	

Press the **▼◀** on the remote control or the **◀** on the control panel to adjust the bottom of the keystone.

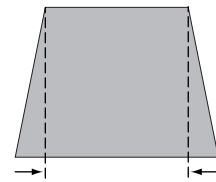

Note

- The adjusted keystone distortion will store automatically even when the signal is interrupted or the AC power cord is plugged out or turned off the projector.
- When the larger amount of keystone correction, the picture quality will degrade and it will get harder to focus with more correction. Set the projector so the correction will be as small as possible.
- When keystone correction is performed, the screen size will also change.
- Part of Closed caption may not be displayed when high compensation values are set in [V Keystone].

Ceiling Mount

This function is used to project the image from a ceiling-mounted projector.

- 1) Press **▲▼** to select [Ceiling Mount].
- 2) Press **▶** to display the choosing dialog box.
- 3) Press **◀▶** to select the desired item.

Front	When setting on a desk/floor and projecting from forward.
Front Ceiling	When mounting on the ceiling and projecting forward.
Rear	When setting on a desk/floor and projecting rear (Using translucent screen).
Rear Ceiling	When mounting on the ceiling and projecting from rear (Using translucent screen).

Setting

Select [Setting] from the Main Menu (see “How to operate menu” on page 33) and then select the item from the Sub Menu.



Language

The language used in the On-Screen Menu is available in English, German, Spanish, French, Italian, Dutch, Portuguese, Japanese, Simplified Chinese, Polish, Korean, Russian, Swedish, Traditional Chinese, Arabic, Norwegian, Turkish, Thai, Czech, Hungarian and Kazakh.

- 1) Press ▲▼ to select [Language].
- 2) Press ► to display the language dialog box.
- 3) Press ▲▼ to select the desired item and press ► to choose.

Menu Location

Switch the menu location on the display screen.

- Change order: Left Top → Right Top → Center → Left Bottom → Right Bottom.

- 1) Press ▲▼ to select [Menu Location].
- 2) Press ► to display the setting dialog box.
- 3) Press ◀▶ to select the desired item.

Closed Caption

[Only for NTSC input].

- 1) Press ▲▼ to select [Closed Caption].
- 2) Press ► to display the setting dialog box.
- 3) Press ◀▶ to select the desired item.

Off	Do not display Closed Caption.
CC1	Displays the CC1 data.
CC2	Displays the CC2 data.
CC3	Displays the CC3 data.
CC4	Displays the CC4 data.

Note

- The closed caption is mainly used in the north America. This function shows the text information contained in the image signal. Captions may not be displayed on some devices or software.
- You can select [Closed Caption] only when NTSC signal is input.
- When Menu screen is displayed, the caption will not be displayed.
- Part of Closed caption may not be displayed when high compensation values are set in [V Keystone].

VGA Out (Standby)

When in standby mode, choose whether to output the signal from <COMPUTER 1> to <MONITOR OUT> terminal.

- 1) Press ▲▼ to select [VGA Out (Standby)].
- 2) Press ► to display the setting dialog box.
- 3) Press ◀▶ to switch [On]/[Off].

On	Output image signal from <MONITOR OUT> terminal when the projector is in standby mode.
Off	Image signal from <MONITOR OUT> terminal can not be output when the projector is in standby mode.

Test Pattern

Use this function to display built-in test pattern when installing the projector.

- 1) Press ▲▼ to select [Test Pattern].
- 2) Press ► to display the setting dialog box.
- 3) Press ◀▶ to switch [On]/[Off].
 - If you want to return the normal mode to the previous image, set [Test Pattern] to [Off] in the [Setting] menu.

On	Display the built-in Test Pattern.
Off	Disable the function.

Remote ID

When you use the system with multiple projectors, you can operate all the projectors simultaneously or each projector individually using single remote control, if a unique ID number is assigned to each projector. There are 7 different remote control IDs: [All], [ID1]~[ID6].

- 1) Press ▲▼ to select [Remote ID].
- 2) Press ► to display the setting dialog box.
- 3) Press ◀▶ to select the desired item.

Attention

- When operating the projector under [All] code, you can operate several projectors at the same time.
- If you want to control the projector with a specified remote control ID, make sure the remote control ID on the remote control fit to the remote control ID on the projector. (►page 20)

Startup Logo

Set this function to display the Panasonic logo when the projector is turning on.

- 1) Press ▲▼ to select [Startup Logo].
- 2) Press ► to display the setting dialog box.
- 3) Press ◀▶ to switch [On]/[Off].

On	The logo will display when the projector is turning on.
Off	The logo will not display when the projector is turning on.

UART Mode

Use this function to select RS-232 or LAN function.

- 1) Press ▲▼ to select [UART Mode].
- 2) Press ► to display the setting dialog box.
- 3) Press ◀▶ to select the desired item.

LAN	Control the projector via <LAN> terminal.
RS-232	Control the projector via <SERIAL IN> terminal.

Note

- When [RS-232] is selected, [LAN(Standby)] and the items of [LAN] are disable.

LAN (Standby)

Use this function to use network function when the projector is in standby mode.

- 1) Press ▲▼ to select [LAN (Standby)].
- 2) Press ► to display the setting dialog box.
- 3) Press ◀▶ to switch [On]/[Off].

On	LAN function is available when in standby mode.
Off	LAN function is unavailable when in standby mode.

Reset

Return all data that has been set in the [Setting] menu to the factory defaults.

- 1) Press ▲▼ to select [Reset].
- 2) Press ► to display the setting dialog box.
- 3) Press ▲▼ to select [Yes].
- 4) Press ► to execute.

Note

- Lamp used time has been set by user in the [Options] menu will not be reset.

Audio

Select [Audio] from the Main Menu (see “How to operate menu” on page 33) and then select the item from the Sub Menu.

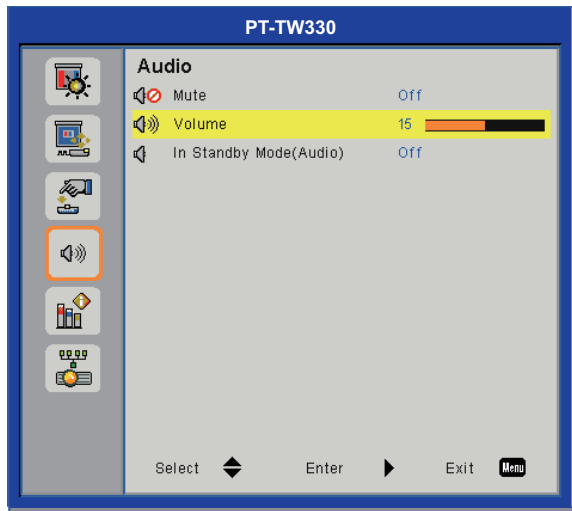

Mute

Temporarily turn off the sound.

- 1) Press ▲▼ to select [Mute].
- 2) Press ► to display the setting dialog box.
- 3) Press ◀▶ to switch [On]/[Off].

On	Mute.
Off	Output audio.

- Press <MUTE> button on the remote control can also turn on/off the sound.

Volume

Adjust the volume.

- 1) Press ▲▼ to select [Volume].
- 2) Press ► to display the adjustment dialog box.
- 3) Press ◀▶ to adjust the volume.

Operation	Adjustment	Adjustment range
Press ►.	Turn up the volume	Maximum value 32
Press ◀.	Turn down the volume	Minimum value 0

- You can also press the <VOLUME +/-> buttons on the remote control or on the control panel.

In Standby Mode (Audio)

This function is used to switch the output audio signal from the <VARIABLE AUDIO OUT> terminal On/Off at standby mode.

- 1) Press ▲▼ to select [In Standby Mode (Audio)].
- 2) Press ► to display the adjustment dialog box.
- 3) Press ◀▶ to switch [On]/[Off].

On	Output the audio signal from the <VARIABLE AUDIO OUT> terminal when in Standby mode.
Off	Mute the audio signal from the <VARIABLE AUDIO OUT> terminal when in Standby mode.

Note

- When setting the [In Standby Mode (Audio)] function to [On] and in Standby mode status, the connected audio signal to <AUDIO 1 IN> terminal can be output from the <VARIABLE AUDIO OUT> terminal. The audio signal output level is fixed and cannot be adjusted.

Options

Select [Options] from the Main Menu (see “How to operate menu” on page 33) and then select the item from the Sub Menu.

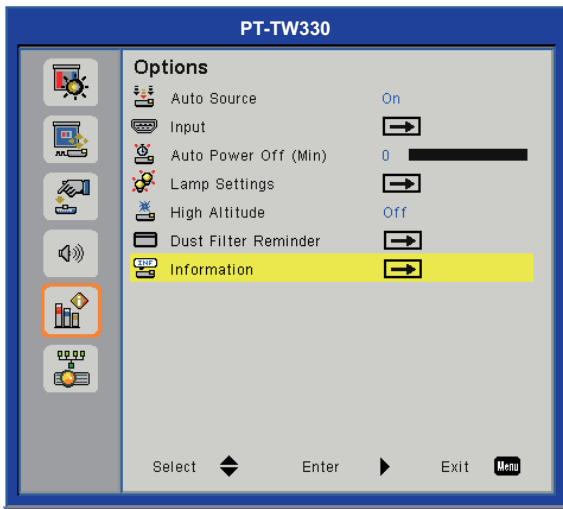

Auto Source

Set the automatic signal search function when power on or the source of the signal being received is lost.

- 1) Press ▲▼ to select [Auto Source].
- 2) Press ► to display the setting dialog box.
- 3) Press ◀▶ to switch [On]/[Off].

On	It will automatically search and display the signal sources marked in the [Input] when power on or the source of the signal being received is lost.
Off	When the source of the signal being received is lost, it will not search other sources.

- Search and display order: [Computer 1] → [Computer 2] → [HDMI] → [Video] → [Computer 1] →...

Input

Set the automatic search signal source for [Auto Source].

- 1) Press ▲▼ to select [Input].
- 2) Press ► to display the setting dialog box.
 - The [Input] menu dialog box is displayed.

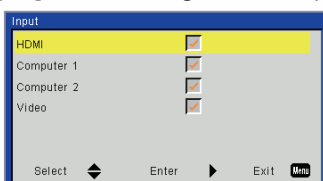

- 3) Press ▲▼ to select the input you want to search and press ►.

- The input with a check mark will be able to be searched when [Auto Source] is set to [On].
- To remove the check mark, choose the desired item and press ►.

Auto Power Off (Min)

Set the time to automatically turn off the projector when there is no signal input.

- 1) Press ▲▼ to select [Auto Power Off (Min)].
- 2) Press ► to display the adjustment dialog box.
- 3) Press ◀▶ to adjust off timer (min).
 - When this function is set to [0 (min)], it is disable.
 - You can set the time in 5 minutes intervals and the longest set time is 120 minutes.

Note

- 60 seconds before the auto power off, the countdown screen will appear. During countdown, the screen will disappear if there is signal input or operation to the projector.

Lamp Settings

Displays and sets detail of the lamp settings.

- 1) Press ▲▼ to select [Lamp Settings].
- 2) Press ► to display the setting dialog box.

Lamp Hours Used (Normal)

- Displays the used lamp hours under [Normal] lamp power mode.

Lamp Hours Used (ECO)

- Displays the used lamp hours (in real time) under [Auto] / [ECO1]([ECO]) / [ECO2] lamp power mode. The time is displayed as the sum of the time under each setting of [Auto], [ECO1]([ECO]) and [ECO2] lamp power mode.

Lamp Life Reminder

- 1) Press ▲▼ to select [Lamp Life Reminder].
- 2) Press ► to display the setting dialog box.
- 3) Press ◀▶ to switch [On]/[Off].

On	Displays the lamp warning message. (▶ page 56)
Off	The warning lamp message will not be displayed.

Options

Attention

- If [Lamp Life Reminder] is set to [Off], the lamp warning message will not be displayed when the lamp used time reaches the end of lamp life. In this case, please check the lamp life with the values at the [Lamp Hours Used (Normal)] and [Lamp Hours Used (ECO)].

Lamp Power Mode

- Selects desired lamp power mode under different situations.

- 1) Press ▲▼ to select [Lamp Power Mode].
- 2) Press ► to display the setting dialog box.
- 3) Press ◀▶ to select the desired item.

Normal	Normal brightness.
Auto	The brightness level of the content is automatically detected to significantly reduced lamp power consumption during periods of inactivity.
ECO1 / ECO *1	Lower brightness reduces the lamp power consumption and extends the lamp life.
ECO2*1	Lowest brightness reduces the lamp power consumption and extends the lamp life.

*1: Normal / Auto / ECO1 / ECO2 for PT-TW330EA / PT-TX300EA.
Normal / Auto / ECO for PT-TW240EA.

Note

- When there is no signal for more than 5 minutes, the lamp power will be decreased automatically for power saving.

Clear Lamp Hours

- Reset the lamp usage time after replacing the lamp unit.

- 1) Press ▲▼ to select [Clear Lamp Hours].
- 2) Press ► to display the setting dialog box.
- 3) Press ▲▼ to switch [Yes]/[No].
- 4) Press ► to execute.

High Altitude

Set to [On] when the projector is used at elevation approx. 1 000 m (3 300 ft) and approx. 3 000 m (10 000 ft).

- 1) Press ▲▼ to select [High Altitude].
- 2) Press ► to display the adjustment dialog box.
- 3) Press ◀▶ to switch [On]/[Off].

On	For the elevation approx. 1 000 m (3 300 ft) and approx. 3 000 m (10 000 ft).
Off	For the elevation below approx. 1 000 m (3 300 ft).

Note

- When [On] is selected, the speed and the noise of the fan will increase.

Dust Filter Reminder

Set the cleaning cycle of the filters and reset the use time of the filters.

- 1) Press ▲▼ to select [Dust Filter Reminder].
- 2) Press ► to display the setting dialog box.

Filters Remind (Hour)

- Set the timer to display the Dust Filter Reminder message (►page 53).

- 1) Press ▲▼ to select [Filters Remind].
- 2) Press ► to display the adjustment dialog box.
- 3) Press ◀▶ to set the time.
 - The factory default is 0 hour.
 - You can set the time in 50 hours intervals and the longest set time is 1000 hours.

Cleaning up Reminder

- Reset the air filter used time to zero.
- Reset the air filter hour counter after cleaning or replacing the dust filter.

- 1) Press ▲▼ to select [Cleaning up Reminder].
- 2) Press ► to display the setting dialog box.
- 3) Press ▲▼ to switch [Yes]/[No].
- 4) Press ► to execute.

Note

- It is recommended to clean the air filters regularly every 500 hours of usage.

Information

Displays the input signal source and setting state information of the projector.

- 1) Press ▲▼ to select [Information].
- 2) Press ► to display the information dialog box.
 - Displays [Model Name], [Source], [Resolution], [Software Version], [Color Space] and [Aspect Ratio].

Select [LAN] from the Main Menu (see “How to operate menu” on page 33) and then select the item from the Sub Menu.

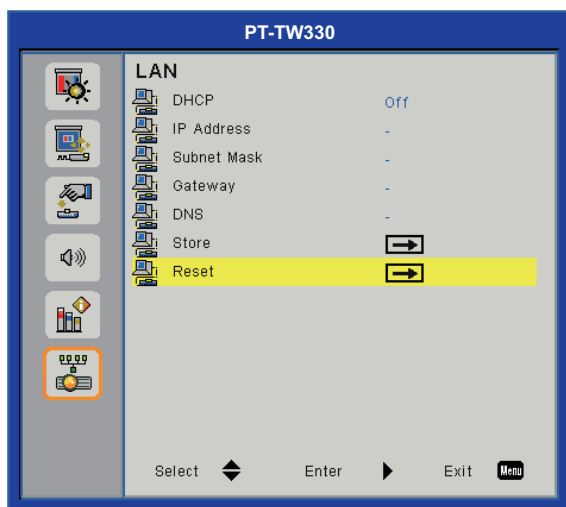

Note

- The following settings are set before the projector leaves the factory.

DHCP	Off
IP Address	192.168.10.100
Subnet Mask	255.255.255.0
Gateway	192.168.10.1
DNS	0.0.0.0

- If you want to use a DHCP server, please make sure that the DHCP server is enabled.
- For more information about the IP Address, Subnet Mask, Gateway, and DNS, please contact your network administrator.

DHCP

Set whether to use DHCP server.

- Press ▲▼ to select [DHCP].
- Press ► to display the setting dialog box.
- Press ▲▼ to switch [On]/[Off].
 - Press <MENU> button to exit the switching and go back to the previous menu.
- Press ► to confirm.
 - After selecting [On], the message about LAN restarting will be displayed. The setting of DHCP finishes when the message disappears.
- Press <MENU> to exit.

On	The projector will acquire the IP address automatically.
Off	User must set the [IP Address], [Subnet Mask], [Gateway] and [DNS] manually.

IP Address

Select an IP Address of projector connected to network.

- Press ▲▼ to select [IP Address].
- Press ► to display the setting dialog box.
- Press ▲▼◀▶ to input digit numbers.
- Press <MENU> to exit.

Subnet Mask

Select Subnet Mask of projector for network connection.

- Press ▲▼ to select [Subnet Mask].
- Press ► to display the setting dialog box.
- Press ▲▼◀▶ to input digit numbers.
- Press <MENU> to exit.

Gateway

Select Gateway of projector for network connection.

- Press ▲▼ to select [Gateway].
- Press ► to display the setting dialog box.
- Press ▲▼◀▶ to input digit numbers.
- Press <MENU> to exit.

DNS

Select DNS of projector for network connection.

- Press ▲▼ to select [DNS].
- Press ► to display the setting dialog box.
- Press ▲▼◀▶ to input digit numbers.
- Press <MENU> to exit.

LAN

Store

Save the network settings.

- 1) Press ▲ ▼ to select [Store].
- 2) Press ► to display the setting dialog box.
- 3) Press ▲ ▼ to switch [Yes]/[No].
- 4) Press ► to execute.
 - Select [Yes] to start executing and the resetting message appears. The store procedure finishes when the message disappears.

Reset

Return all data that has been set in the [LAN] menu to the factory defaults.

- 1) Press ▲ ▼ to select [Reset].
- 2) Press ► to display the setting dialog box.
- 3) Press ▲ ▼ to switch [Yes]/[No].
- 4) Press ► to execute.
 - Select [Yes] to start executing and the resetting message appears. The reset procedure finishes when the message disappears.

Connect to Network

The projector has a network function, and the following operations are available from the computer using the web browser control.

- Setting and adjustment of the projector.
- Display of the projector status.
- Transmission of an E-mail message when there is a problem with the projector.

This projector supports "Crestron RoomView" and the following application software from Crestron company. (➔page 51)

- RoomView Express

Attention

- Connects LAN to indoor equipment.
- Set the [UART Mode] in the [Setting] menu to [LAN] before controlling the projector via <LAN> terminal.

Note

- A LAN cable is required to use the wired LAN function.

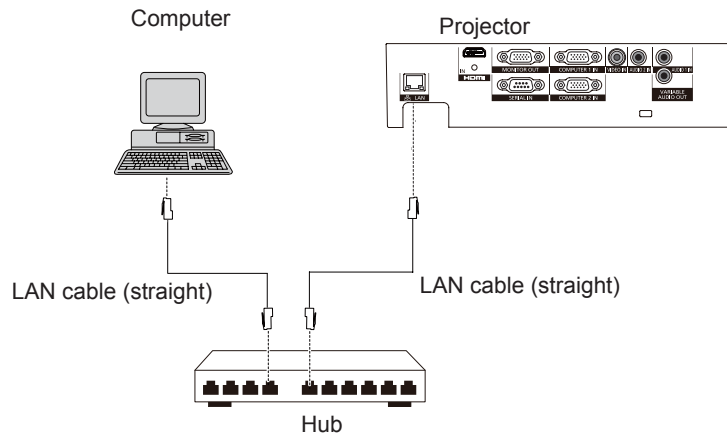

- A Web browser is required to use this function. Confirm that the Web browser can be used beforehand.
Compatible OS : Windows XP/Windows Vista/Windows 7, Mac OS X v10.4/v10.5/v10.6/v10.7
Compatible Web Browser : Internet Explorer 7.0/8.0/9.0, Safari 4.0/5.0 (Mac OS)
- Communication with an E-mail server is required to use the E-mail function. Confirm that the E-mail can be used beforehand.
- Use shielded LAN cable (STP cable) that is compatible with category 5 or above.
- Use a LAN cable with length of 100 m or shorter.

■ Name and function of network function parts

(1) ACT lamp (yellow)

Blinks when the LAN network function acts normal.

(2) LAN terminal (10BASE-T/100BASE-TX)

Used to connect the LAN cable here.

(3) LINK lamp (green)

Lights on when connected to network.

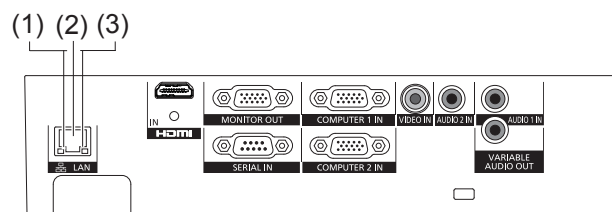

Computer operation via network

Connection can be made with wired LAN. However, confirm to your system administrator on network settings before changing any settings.

1) Turn on the computer.

2) Make the network setting according to your system administrator.

If the projector settings are the default settings (➡ page 45), the computer can be used with the following network settings.

DHCP	Off
IP Address	192.168.10.101
Subnet Mask	255.255.255.0
Gateway	192.168.10.1
DNS	NONE

Web Management

1) Start the WEB browser of the computer.

2) URL input box of the WEB browser and the IP Address setting of the projector.



3) Enter password.

- Input the administrator password. (➡ page 50)

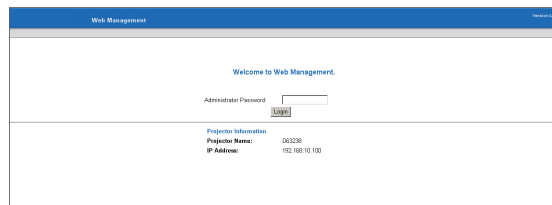

4) Click Login button.

- Display [Projector Information] page.

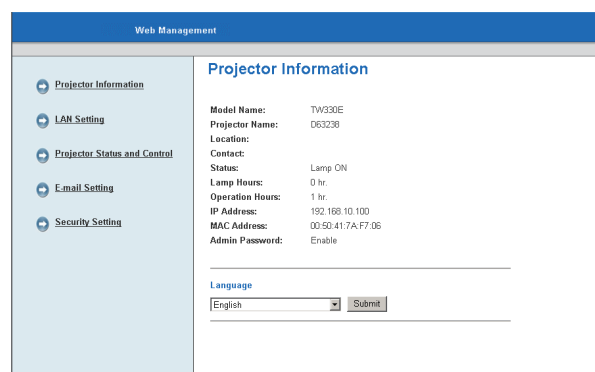

- Select page menu on the left to display detail page.

Note

- For security reason, set an administrator password for the Web Management and restrict the users who can log in. (➡ page 50)
- Network connection will be disconnected when you cut off the power, such as unplug the power cord. When you want to operate the WEB browser after reconnecting the power, please press [F5] on the keyboard to refresh your browser.

Main Menu description

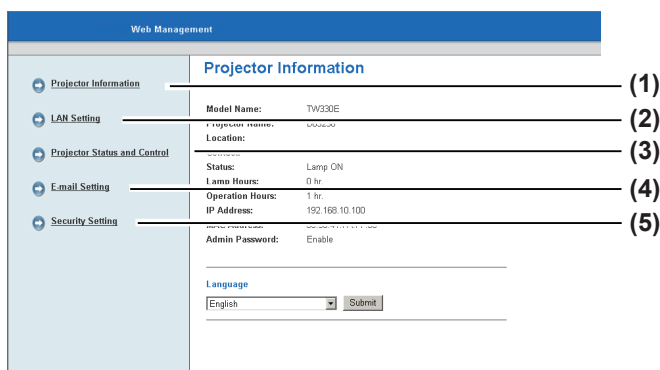

- (1) **Projector Information**
Click this item and the [Projector Information] displays.
- (2) **LAN Setting**
Click this item and the [LAN Setting] displays.
- (3) **Projector Status and Control**
Click this item and the [Projector Status and Control] displays.
- (4) **E-mail Setting**
Click this item and the [E-mail Setting] displays.
- (5) **Security Setting**
Click this item and the [Security Setting] displays.

Projector Information

Displays basic information of the projector.

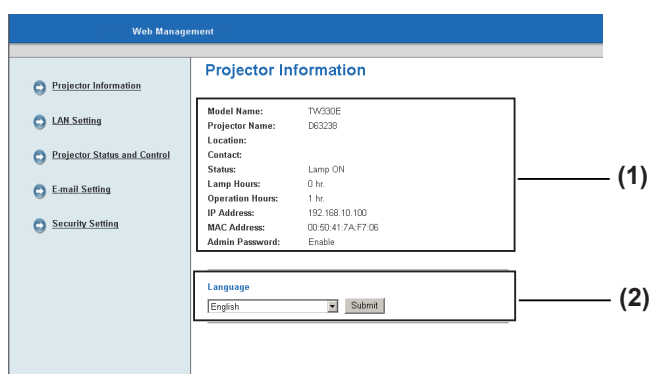

- (1) **Projector Information**
Confirm Projector Information.
Displays lamp use time [Lamp Hours] (corresponding value) and projector running hour [Operation Hours].
- (2) **Language**
Select Web Management display language (21 languages).
 - Switches languages among English / German / French / Italian / Spanish / Dutch / Portuguese / Japanese / Traditional Chinese / Simplified Chinese / Korean / Russian / Polish / Swedish / Arabic / Turkish / Norwegian / Czech / Hungarian / Kazakh / Thai.
 The On-screen Menu of Language of the projector can not be changed by the Web management menu.

LAN Setting

Sets the LAN Setting of the projector and press [Save] to store settings.

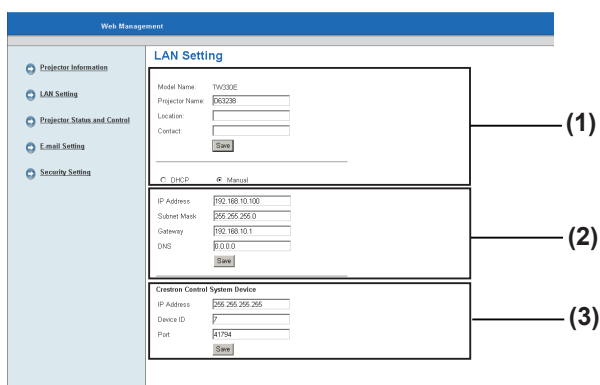

- (1) **[Model Name] [Projector Name] [Location] [Contact]**
Enter projector basic information and press [Save].
- (2) **[DHCP] [Manual]**
Select [DHCP] when the DHCP client function is enable.
[IP Address] [Subnet Mask] [Gateway] [DNS]
When DHCP server is unavailable, please select [Manual] and enter [IP Address], [Subnet Mask], [Gateway] and [DNS].
- (3) **[Crestron Control System Device]**
Enter [IP Address], [Device ID] and [Port] when Crestron RoomView is in use and press [Save].

Attention

- For the security reason, do not enter any information that third party can recognize your location or name, in [Location] and [Contact] columns.

Projector Status and Control

Sets the projector status and adjusts Image and Audio controls.

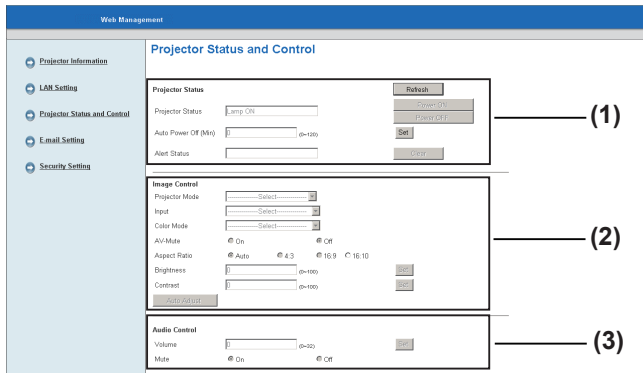

(1) [Projector Status]

Confirm Projector Status.
Press [Refresh] button to refresh.
Press [Power ON] or [Power OFF] button to operate power status.
Set the time for the projector to shut down automatically when there is no signal input in [Power Saving].
Confirm the [Alert status] of abnormal conditions.

(2) [Image Control]

Adjust projector image.
Use the [Auto Adjust] button to adjust image to the best position and size.

(3) [Audio Control]

Adjust projector volume.

E-mail Setting

Sets E-mail Alert and SMTP Setting and Alert Condition of the projector and press [Save] to store settings.

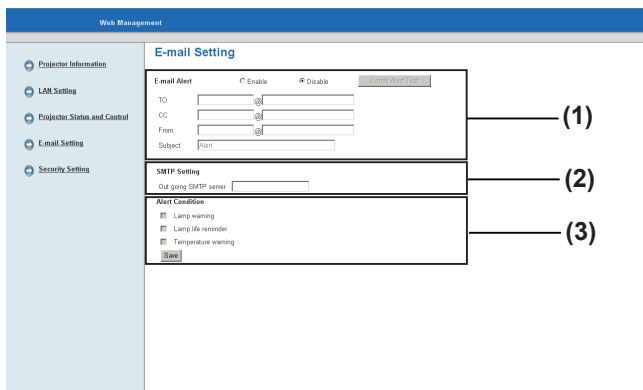

(1) [E-mail Alert]

Click [Enable] when using the E-mail function.
Login [TO], [CC], [From] of the E-mail address to enable the abnormal E-mail notification.
{up to 40 characters in single byte (15+@+24)}
You can enter [Subject] information such as the location of the projector that notifies the sender of the E-mail. (up to 30 characters in single byte)

(2) [SMTP Setting]

Login [Out going SMTP server]
(up to 30 characters in single byte)

(3) [Alert Condition]

Login [Lamp warning], [Lamp life reminder], [Temperature warning] of the Alert Condition to enable the abnormal E-mail notification. (▶page 60)

Note

- The E-mail function of this projector does not compatible with the advanced SMTP server.

Security Setting

Sets a password for the administrator to manage the Web.

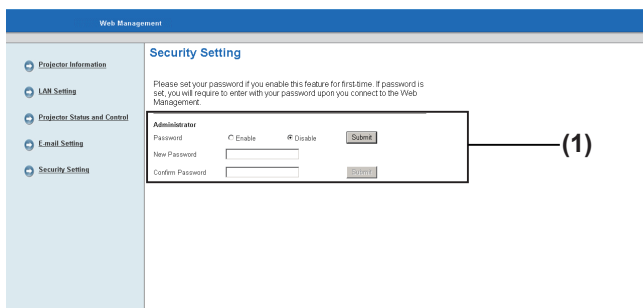

(1) [Administrator]

When set the password, click [Enable] and enter both of [New Password] and [Confirm Password] {4 characters in single byte (0~9, A~Z, a~z)}, and then click [Submit].

■ Crestron RoomView Control Tool

"Crestron RoomView" is a system developed by Crestron Electronics, Inc. which collectively manage and control multiple system devices connected via the network, from a computer.

For details of "Crestron RoomView", refer to the Crestron Electronics, Inc. website (Provided only in English).

<http://www.crestron.com/>

For the download of "RoomView Express", refer to the Crestron Electronics, Inc. website (Provided only in English).

<http://www.crestron.com/getroomview>

RoomView Express image example

- The following picture is the start example of the downloaded [RoomView Express] after installation.
- For detail operation, please refer to [RoomView Help File].

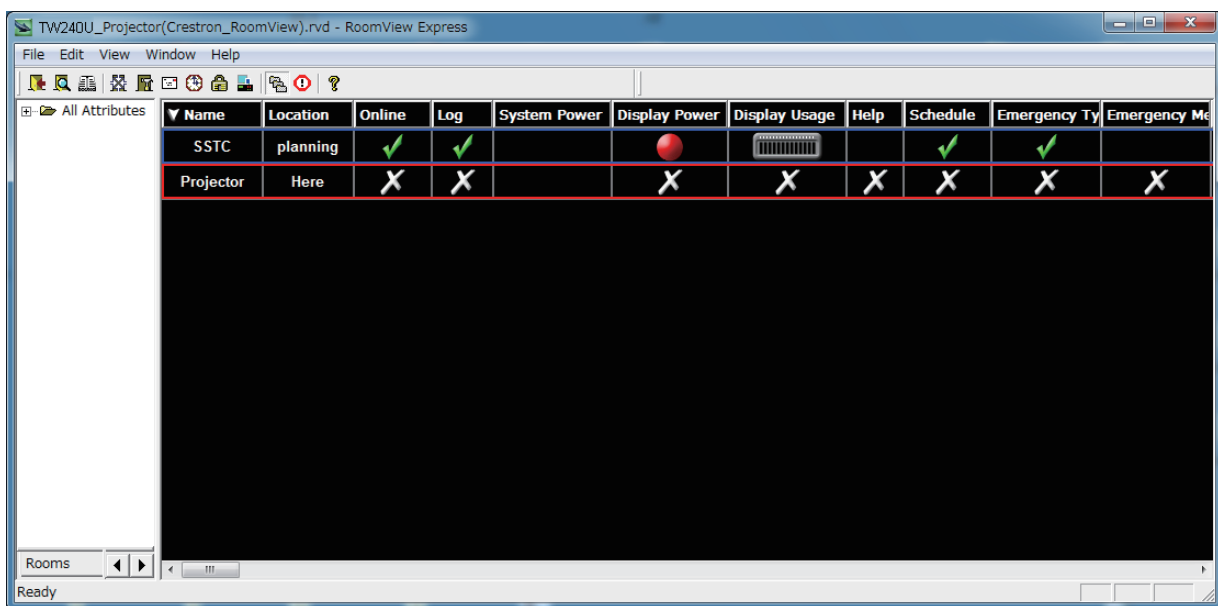

About indicator status

If an indicator turns on

If a problem should occur inside the projector, the <TEMP> and/or <LAMP> indicators will inform you. Manage the indicated problems as follow.

Attention

- Before you take a remedial measure, follow the procedure of switching the power off indicated in “Powering off the projector”. (➔page 29)
- Confirm the status of the power indicated on the <ON(G)/STANDBY(R)> indicator. (➔page 28)

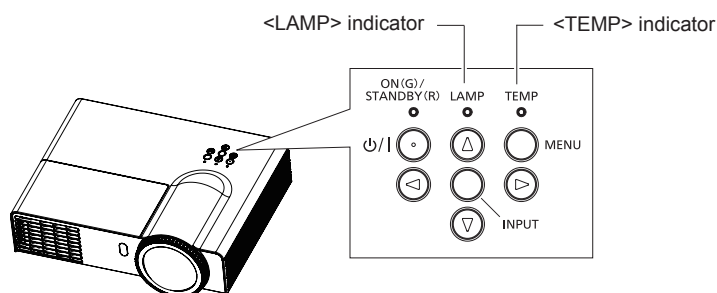

<TEMP> indicator

Indicator status	Status	Check	Remedy
Lights in red	Temperature too high	Is the air intake/exhaust port blocked?	Remove any objects that are blocking the air intake/exhaust port.
		Are the air filters blocked?	See air filters cleaning or replacing. (➔pages 53-55)
		Is the room temperature high?	Set up the projector in a location with an ambient temperature of 5°C (41°F) to 40°C (104°F)*.
		Is the projector used above the altitude of 1 000 m (3 300 ft) ?	- Use the projector between the altitude approx. 1 000 m (3 300 ft) and approx. 3 000 m (10 000 ft) and set [High Altitude] to [On]. (➔page 44) - Do not use the projector at elevations approx. 3 000 m (10 000 ft).
Blinks in red	The fan has stopped	--	Disconnect the power plug from the power outlet and contact your dealer.

* For the elevations below approx. 750 m (2 500 ft). When using the projector at the elevations between approx. 750 m (2 500 ft) and approx. 1 500 m (5 000 ft) sea level, temperature will be 5°C (41°F) to 35°C (95°F). When using the projector at the elevations between approx. 1 500 m (5 000 ft) and approx. 3 000 m (10 000 ft) sea level, temperature will be 5°C (41°F) to 30°C (86°F).

<LAMP> indicator

Indicator status	Status	Check	Remedy
Lights in red	Lamp does not light; or lights out during projection	Does the projector be turned on immediately after powering off?	Turn on the projector until the lamp has completely cooled down.
		Lamp unit failure; abnormal lamp power; lamp broken	Disconnect the power plug from the power outlet, and contact your dealer.

Note

- When re-start the projector, turn off the projector, unplug the power cord, and then wait 30 seconds or more before reconnecting power.
- If the <TEMP> indicator lights or flashes or the <LAMP> indicator lights despite taking the actions above, plug out the AC power cord, and contact your dealer for repair.

Maintenance/replacement

Before cleaning/replacing the unit

- When you perform maintenance or replacement of the parts, make sure to turn off the power and disconnect the power plug from the wall outlet. (➔pages 27, 29)
- Be sure to observe the procedure “Powering off the projector” (➔page 29) when performing power supply operation.

Maintenance

Outer Case

Wipe off dirt and dust using a soft dry cloth.

- If the dirt is persistent, soak the cloth with water and wring it thoroughly before wiping. Dry off the projector with a dry cloth.
- Do not use benzene, thinner, or rubbing alcohol, other solvents, household cleaners. Using them may cause deterioration of the outer case.
- When using chemical treated dusters, follow its instruction.

Front glass surface of the lens

Wipe off the dirt and dust off the front surface of the lens with soft clean cloth.

- Do not use a cloth that has an abrasive surface or a cloth that is moist, oily, or covered with dust.
- Do not use excessive force when wiping the lens as it is fragile.

Attention

- The lens are made of glass. Impacts or excessive force when wiping may scratch its surface. Please handle with care.

Air filters

If too much dust accumulates in the air filter, the internal temperature of the projector can not be maintained at the normal level. Clean the filters after every 500 hours of usage.

- When the Dust Filter Reminder message is displayed.

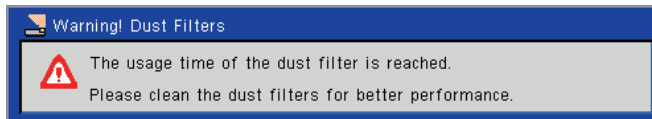

- When <TEMP> indicator lights in red and then the projector is turned off automatically.

- 1) Turn off the projector, and remove the AC power plug from the AC outlet.
- 2) Clean up the dust on the projector and around the air vents.
- 3) Pull out the air filters straight and slowly with grabbing the knobs.

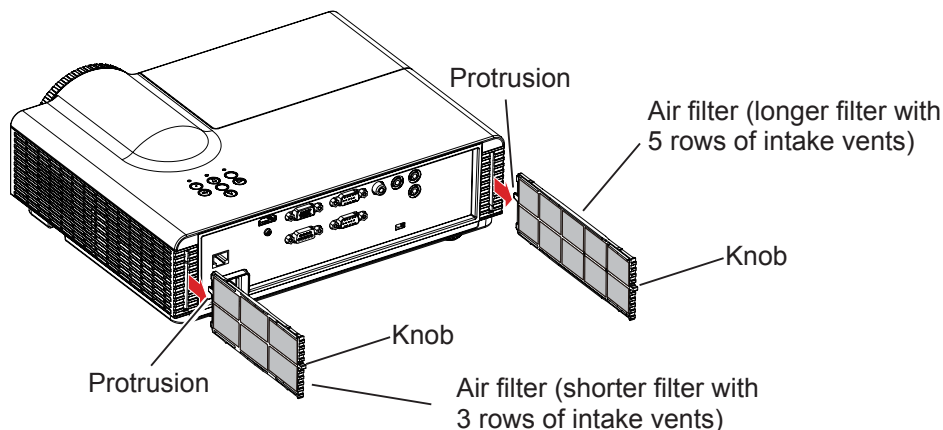

4) Clean the air filters.

- Vacuum dirt and dust from the air filters.

Maintenance/replacement

5) Install the air filters.

- Hold the air filters with the protrusion up towards the top panel as shown in the picture and insert them until you hear a "click" sound.

6) Reset the [Filter Reminder].

- Turn on the power and perform [Cleaning up Reminder] in the [Options] menu. (➡page 44)

Attention

- Turn off the power before you clean the air filters.
- Be sure to attach the air filters properly. If you use the projector without attaching the air filters, the projector may be damaged due to the dirt or dust.

Note

- If the air filter has been damaged or dust / dirt can not be removed, please replace it with a new filter.
- The <TEMP> indicator lights up and the warning temperature message displays because of clogging within 500 hours, depending on the using environment. In that case, clean the air filters at short intervals.

Replacing the unit

■ Air filters

The air filter should be replaced when cleaning is ineffective.

A replacement air filter unit is available separately. (service component)

Contact your dealer for the optional air filters.

Also, please replace the air filters together when replacing the lamp unit.

The air filters (Part Number: Longer filter with 5 rows of intake vents H518PC13G041, Shorter filter with 3 rows of intake vents H518PC12G041) are included with the [ET-LAL331 / ET-LAL341] replacement lamp unit.

■ Replacement of the air filters

- 1) Turn off the projector, and remove the AC power plug from the AC outlet.
- 2) Clean up the dust on the projector and around the air vents.
- 3) Pull out the air filters straight and slowly with grabbing the knobs.

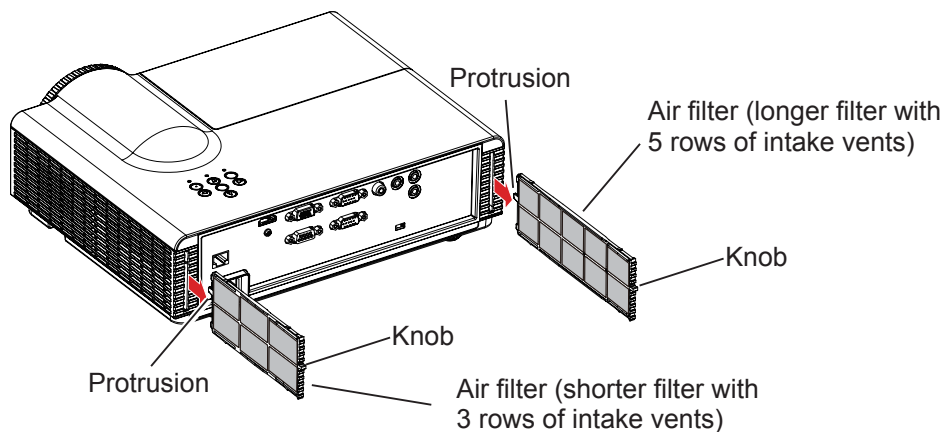

4) Install the new air filters (Replacement air filters).

- Hold the air filters with the protrusion up towards the top panel as shown in the picture and insert them until you hear a "click" sound.

5) Reset the [Filter Reminder].

- Turn on the power and perform [Cleaning up Reminder] in the [Options] menu. (➡ page 44)

Attention

- Turn off the power before you replace the air filters.
- When attaching the air filter unit, make sure that the projector is stable, and work in an environment that is safe, even in the event of the air filter unit dropping.
- Do not operate the projector with the air filter unit removed. Dust may accumulate on the optical elements degrading picture quality.
- Do not put anything into the air vents. Doing so may result in malfunction of the projector.

■ Lamp unit

The lamp unit is a consumable component. See "When to replace the lamp unit" about the lifespan.

It is recommended to ask an authorized engineer to replace the lamp unit. Contact your dealer.

Consult your dealer to purchase a replacement lamp unit.

(for PT-TW330EA / PT-TX300EA: ET-LAL341; for PT-TW240EA: ET-LAL331)

CAUTION:

- Do not replace the lamp unit when it is hot. (Wait at least 1 hour after use.)

The inside of the cover can become very hot, take care to avoid burn injuries.

Maintenance/replacement

Notes on the replacement of the lamp unit

- The luminous source of the lamp is made of glass and may burst if you hit it against a hard surface or drop it. Please handle with care.
- A Phillips screwdriver is required for replacement of the lamp unit.
- Be careful of hands slip when you using a screwdriver.
- When replacing the lamp unit, be sure to hold it by the handle.
- When replacing the lamp because it has stopped illuminating, there is a possibility that the lamp may be broken. If replacing the lamp of a projector which has been installed on the ceiling, you should always assume that the lamp is broken, and you should stand to the side of the lamp cover, not underneath it. Remove the lamp cover gently. Small pieces of glass may fall out when the lamp cover is opened. If pieces of glass get into your eyes or mouth, seek medical advice immediately.
- The lamp contains mercury. Consult your local municipality or your dealer about correct disposal of used lamp units.

Attention

- Be sure to use the lamp unit specified.

Note

- The part numbers of accessories and separately sold components are subject to change without notice.

When to replace the lamp unit

The lamp unit is a consumable component. Brightness decreases according to duration of usage, so periodical replacement of the lamp unit is necessary. The estimated duration before replacement is 3 000 hours for PT-TW330EA / PT-TX300EA, 4 000 hours for PT-TW240EA. However, this may be shortened depending on individual lamp characteristics, usage conditions, and the installation environment. Therefore, it is strongly recommended that a replacement lamp unit be prepared. When the projection lamp of the projector reaches its end of life, the warning message appears on the screen. Replace the lamp with a new one promptly.

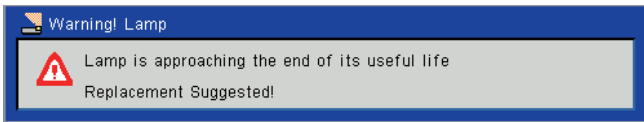
Model name	Lamp runtime	On screen:Warning Lamp message
		
PT-TW330EA / PT-TX300EA	Over 2 970 hours	If the lamp is used over 2 970 hours, the warning message will appear. When any button is pressed, the message will disappear.
PT-TW240EA	Over 3 970 hours	If the lamp is used over 3 970 hours, the warning message will appear. When any button is pressed, the message will disappear.

Attention

- If [Lamp Life Reminder] is set to [Off], the lamp warning message will not be displayed when the lamp used time reaches the end of lamp life. In this case, please check the lamp life with the values at the [Lamp Hours Used (Normal)] and [Lamp Hours Used (ECO)].

Note

- The usage period of 3 000 hours / 4 000 hours is a rough estimate and is not guaranteed.
- Used for PT-TW330EA/TX300EA
The used lamp time is calculated internally in the following formula as the used time in each setting of [Normal], [Auto], [ECO1] and [ECO2] in [Lamp power mode]:
Lamp runtime = (Lamp runtime of [Normal] × 60 + Lamp runtime of [Auto] × 24 + Lamp runtime of [ECO1] or [ECO2] × 45) ÷ 60
 - In order to estimate the lamp life, please refer to [Lamp Hours Used (Normal)] and [Lamp Hours used (ECO)] in the [Lamp settings] menu (▶ page 43). [Lamp Hours Used (ECO)] is a total real time under [Auto], [ECO1] and [ECO2] lamp power modes. Please note that they are not displayed individually.
 - Lamp use time = ([Lamp Hours Used (Normal)] × 60 + [Lamp Hours Used (ECO)] × α₁) ÷ 60
When setting under both [Normal] and [ECO1]/[ECO2], not using [Auto]: α₁ = 45
When setting under both [Normal] and [Auto], not using [ECO1]/[ECO2]: α₁ = 24
When setting under both [ECO1]/[ECO2] and [Auto]: 24 < α₁ < 45
The ratio of α₁ will be smaller if the used time of [Auto] is more than that of [ECO1]/[ECO2].

- Used for PT-TW240EA

The used lamp time is calculated internally in the following formula as the used time in each setting of [Normal], [Auto] and [ECO] in [Lamp power mode]:

$$\text{Lamp runtime} = (\text{Lamp runtime of [Normal]} \times 51 + \text{Lamp runtime of [Auto]} \times 24 + \text{Lamp runtime of [ECO]} \times 34) \div 51$$

- In order to estimate the lamp life, please refer to [Lamp Hours Used (Normal)] and [Lamp Hours used (ECO)] in the [Lamp settings] menu (➔ page 43). [Lamp Hours Used (ECO)] is a total real time under [Auto] and [ECO] lamp power modes. Please note that they are not displayed individually.

- Lamp use time = ([Lamp Hours Used (Normal)] × 51 + [Lamp Hours Used (ECO)] × α₂) ÷ 51

When setting under both [Normal] and [ECO], not using [Auto]: α₂ = 34

When setting under both [Normal] and [Auto], not using [ECO]: α₂ = 24

When setting under both [ECO] and [Auto]: 24 < α₂ < 34

The ratio of α₂ will be smaller if the used time of [Auto] is more than that of [ECO].

Replacing the Lamp unit

Attention

- When the projector is mounted on a ceiling, do not work with your face close to the projector.
- Attach the lamp unit and the lamp cover securely.
- When you experience difficulty in installing the lamp, remove it and try again. If you use force to install the lamp, the connector may be damaged.
- Do not loosen other than designated screws.

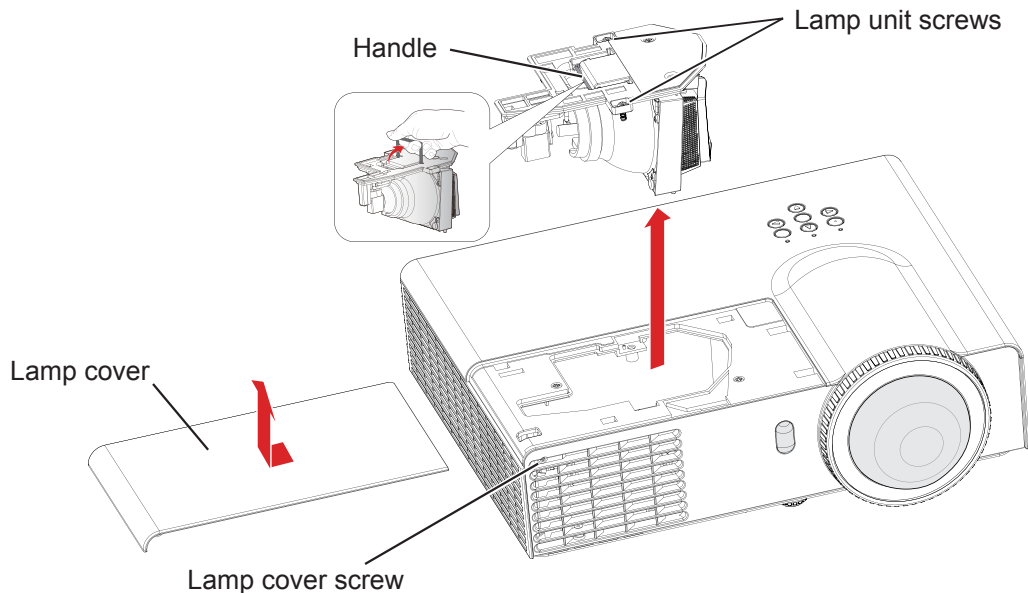

- 1) Turn off the Power by following the procedure in "Powering off the projector". (➔page 29). Remove the AC power plug from the wall outlet. Wait at least 1 hour and make sure the lamp unit and surroundings are cool.
- 2) Use a Phillips screwdriver to loosen the lamp cover screw and open the lamp cover.
 - Open the lamp cover by pulling it slowly toward the direction of the arrow.
- 3) Use a Phillips screwdriver to loosen the two lamp unit screws until the screws turn freely. Pull up the handle, and pull out the lamp unit gently.
- 4) Insert the new lamp unit in correct direction. Tighten the two lamp unit screws securely with a Phillips screwdriver.
- 5) Close the lamp cover, and tighten the Lamp cover screw securely with a Phillips screwdriver.

Reset the Lamp Hours Used

After replacing the lamp unit, make sure to reset the usage time in the [Clear Lamp Hours] menu. (➔page 44)

Troubleshooting

Please check following points. For details, see the corresponding pages.

Problem	Cause	Reference page
Power does not turn on.	● The power cord may not be connected.	—
	● No electric supply is at the wall outlet.	—
	● The circuit breakers have tripped.	—
	● Is the <LAMP> indicator, <ON(G)/STANDBY(R)> indicator, or <TEMP > indicator lit or blinking?	28, 52
	● The lamp cover has not been securely installed.	57
No picture appears.	● The video signal input source may not be connected to a terminal properly.	26
	● The input selection setting may not be correct.	30
	● The [Brightness] adjustment setting may be at the minimum setting.	36
	● The input source which is connected to the projector may have a problem.	—
	● The [AV mute] function may be in use.	16
The picture is fuzzy.	● The lens focus may not have been set correctly.	30
	● The projector may not be at the correct distance from the screen.	22~23
	● The lens may be dirty.	53
	● The projector may be tilted too much.	—
The color is pale or grayish.	● [Color Mode] or [Hue] adjustment may be incorrect.	36~37
	● The input source which is connected to the projector may not be adjusted correctly.	—
	● RGB cable is damaged.	—
No sound from the internal speaker	● The input terminals may not have been correctly connected.	26
	● The volume may have been set to the minimum level.	42
	● The [AV mute] function may have been turned on.	16
	● When the VARIABLE AUDIO OUT is plugged-in, the projector's built-in speaker is not available.	19
	● The Mute function may have been turned on.	42
The remote control does not operate.	● The battery may be weak.	—
	● The battery may not have been inserted correctly.	20
	● The remote control signal receptor on the projector may be obstructed.	16
	● The remote control unit may be out of the operation range.	16
	● Strong light such as fluorescent shine onto the signal receptor.	16
	● When different remote IDs are set on the projector and on the remote control.	20, 41

Problem	Cause	Reference page																		
Partial, scrolling or incorrectly displayed image	<ul style="list-style-type: none"> For computer input, press the <AUTO ADJ.> button on the remote control. If you are using a Windows PC: <ol style="list-style-type: none"> Open the [My Computer] icon, then click the [Control Panel] folder. Click the [Display] icon and select the [Settings] tab and set the display resolution lower than or equal to UXGA (1600 × 1200). If you are using a Notebook: <ol style="list-style-type: none"> First, follow the steps above to adjust resolution of the computer. Press the appropriate keys listed below for your notebook manufacturer to send signal out from notebook to projector. 	—																		
	<table border="1"> <tr> <td>Panasonic ⇒ [Fn]+[F3]</td> <td>SAMSUNG ⇒ [Fn]+[F4]</td> </tr> <tr> <td>Gateway ⇒ [Fn]+[F4]</td> <td>Acer ⇒ [Fn]+[F5]</td> </tr> <tr> <td>SHARP ⇒ [Fn]+[F5]</td> <td>TOSHIBA ⇒ [Fn]+[F5]</td> </tr> <tr> <td>IBM/Lenovo ⇒ [Fn]+[F7]</td> <td>LG ⇒ [Fn]+[F7]</td> </tr> <tr> <td>SONY ⇒ [Fn]+[F7]</td> <td>EPSON ⇒ [Fn]+[F8]</td> </tr> <tr> <td>Asus ⇒ [Fn]+[F8]</td> <td>FUJITSU ⇒ [Fn]+[F10]</td> </tr> <tr> <td>NEC ⇒ [Fn]+[F3]/[F5]</td> <td>HP/Compaq ⇒ [Fn]+[F4]/[F5]</td> </tr> <tr> <td>DELL ⇒ [Fn]+[F1]/[F8]</td> <td></td> </tr> <tr> <td colspan="2">Apple ⇒ [F7]/[Command]+ [F2] or System Preference ⇒ Monitor ⇒ Resolution</td> </tr> </table>	Panasonic ⇒ [Fn]+[F3]	SAMSUNG ⇒ [Fn]+[F4]	Gateway ⇒ [Fn]+[F4]	Acer ⇒ [Fn]+[F5]	SHARP ⇒ [Fn]+[F5]	TOSHIBA ⇒ [Fn]+[F5]	IBM/Lenovo ⇒ [Fn]+[F7]	LG ⇒ [Fn]+[F7]	SONY ⇒ [Fn]+[F7]	EPSON ⇒ [Fn]+[F8]	Asus ⇒ [Fn]+[F8]	FUJITSU ⇒ [Fn]+[F10]	NEC ⇒ [Fn]+[F3]/[F5]	HP/Compaq ⇒ [Fn]+[F4]/[F5]	DELL ⇒ [Fn]+[F1]/[F8]		Apple ⇒ [F7]/[Command]+ [F2] or System Preference ⇒ Monitor ⇒ Resolution		
	Panasonic ⇒ [Fn]+[F3]	SAMSUNG ⇒ [Fn]+[F4]																		
	Gateway ⇒ [Fn]+[F4]	Acer ⇒ [Fn]+[F5]																		
	SHARP ⇒ [Fn]+[F5]	TOSHIBA ⇒ [Fn]+[F5]																		
	IBM/Lenovo ⇒ [Fn]+[F7]	LG ⇒ [Fn]+[F7]																		
	SONY ⇒ [Fn]+[F7]	EPSON ⇒ [Fn]+[F8]																		
	Asus ⇒ [Fn]+[F8]	FUJITSU ⇒ [Fn]+[F10]																		
	NEC ⇒ [Fn]+[F3]/[F5]	HP/Compaq ⇒ [Fn]+[F4]/[F5]																		
	DELL ⇒ [Fn]+[F1]/[F8]																			
Apple ⇒ [F7]/[Command]+ [F2] or System Preference ⇒ Monitor ⇒ Resolution																				
<ul style="list-style-type: none"> If you experience difficulty changing resolutions or your monitor freezes, restart all equipment including the projector. 																				
The screen of the Notebook computer is not displaying your presentation	<ul style="list-style-type: none"> Some Notebook PCs may deactivate their own screens when a second display device is in use. Each has a different way to be reactivated. Refer to your computer's manual for detailed information. 	—																		
Image is unstable or flickering	<ul style="list-style-type: none"> Adjust [Phase] in the [Position] menu. 	38																		
Vertical lines can be seen from the image	<ul style="list-style-type: none"> Adjust [Clock] in the [Position] menu. Please change the output of the computer that is compatible with this projector. 	38																		
The image may be stretched due to different video sources	<ul style="list-style-type: none"> When the video source is 16:9, adjust [16:9] in [Aspect Ratio] in the [Position] menu. When the video source is 4:3, adjust [4:3] in [Aspect Ratio] in the [Position] menu. If the image remains stretched after the previous settings, please adjust the aspect ratio of the player. 	38																		
Image is too small or too large	<ul style="list-style-type: none"> Move the projector closer to or further from the screen. 	22~23																		
	<ul style="list-style-type: none"> Confirm [Aspect Ratio] in the [Position] menu. 	38																		
Image is reversed	<ul style="list-style-type: none"> Confirm [Ceiling Mount] in the [Position] menu. 	39																		
The projector stops responding to all controls	<ul style="list-style-type: none"> If possible, turn off the projector, then unplug the power cord and wait at least 30 seconds before reconnecting power. 	52																		
Lamp burns out or makes a popping sound	<ul style="list-style-type: none"> When the lamp reaches its end of life, it will burn out and may make a loud popping sound. If this happens, the projector will not turn on until the lamp module has been replaced. 	—																		

Troubleshooting

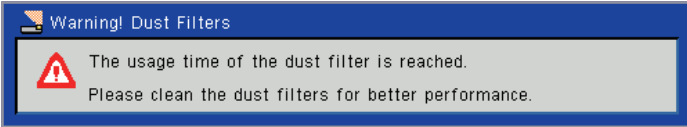
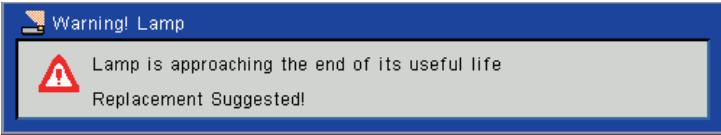
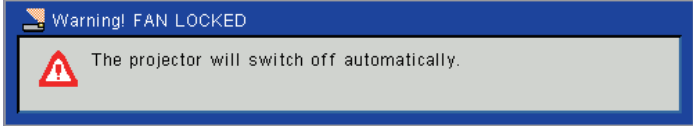
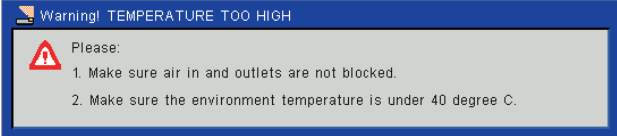
Problem	Cause	Reference page
Messages displays	<ul style="list-style-type: none"> ● Dust Filter Reminder Message:  <p>The usage time of the dust filter is reached. Please clean the dust filters for better performance.</p> <p>This message displays when the projector reached the timer set in the [Filter Reminder (Hour)]. In this case, please clean the air filters or replace them.</p>	53
	<ul style="list-style-type: none"> ● Lamp Warning Message:  <p>Lamp is approaching the end of its useful life Replacement Suggested!</p> <p>The lamp has reached its end of life, please replace it as soon as possible.</p>	56
	<ul style="list-style-type: none"> ● Fan Locked Warning Message:  <p>The projector will switch off automatically.</p> <p>This shows the fan has stopped during projection and the power will be shut off soon. Unplug the power cord from the outlet and contact your dealer for details.</p>	52
	<ul style="list-style-type: none"> ● Temperature Fail Message :  <p>Please:</p> <ol style="list-style-type: none"> 1. Make sure air in and outlets are not blocked. 2. Make sure the environment temperature is under 40 degree C. <p>The internal temperature is too high and the power will be shut off soon, please confirm the display items.</p>	

Attention

- Please contact your dealer if the projector still can not be operated normally after following the instructions above.

Note

- The <AUTO ADJ.> operation may not optimize the image position or the resolution, depending on the input signal format or the image contents. In this case, switch to a different image and execute <AUTO ADJ.> again.

Appendix

Serial terminal

The serial connector which is on the connector panel of the projector conforms to the RS-232C interface specification, so that the projector can be controlled by a personal computer which is connected to this connector.

Attention

- Set the [UART Mode] in the [Setting] menu to [RS-232] before controlling the projector via <SERIAL IN> terminal.

Connection

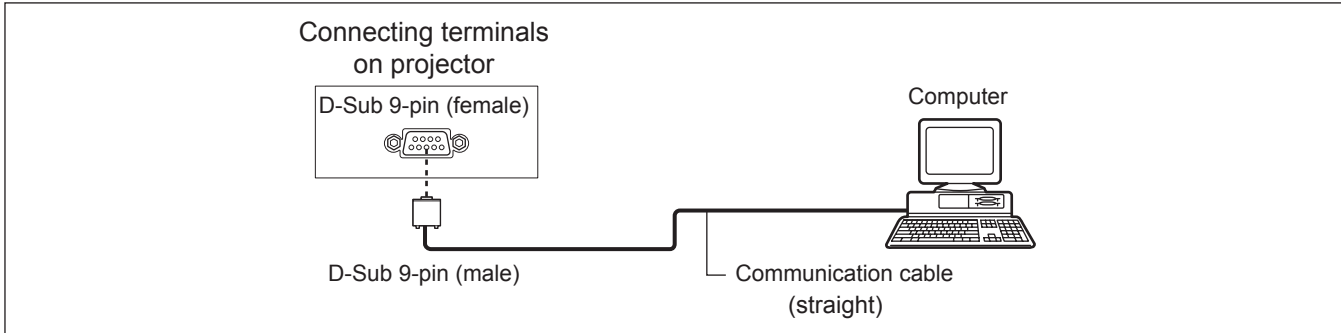

Pin assignments and signal names

D-Sub 9-pin (female) Outside view	Pin No.	Signal name	Contents
		①	—
②		TXD	Transmitted data
③		RXD	Received data
④		—	NC
⑤		GND	Earth
⑥		—	NC
⑦		CTS	Connected internally
⑧		RTS	
⑨		—	NC

Communication conditions

Signal level	RS-232C-compliant
Sync. method	Asynchronous
Baud rate	19 200 bps
Parity	None

Character length	8 bits
Stop bit	1 bit
X parameter	None
S parameter	None

Cable specifications

[When connected to a computer]

Projector	1	NC	NC	1	Computer (DTE specifications)
	2			2	
	3			3	
	4	NC	NC	4	
	5			5	
	6	NC	NC	6	
	7			7	
	8			8	
	9	NC	NC	9	

Basic format

Transmission from the computer begins with STX, then the command, parameter, and ETX are sent in this order. Add parameters according to the details of control.

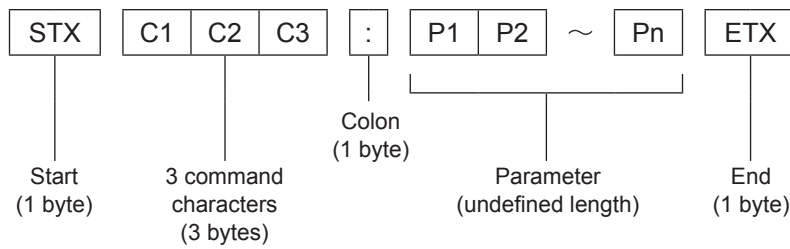

*: When sending commands without parameters, a colon (:) is not necessary.

Basic format (with sub command)

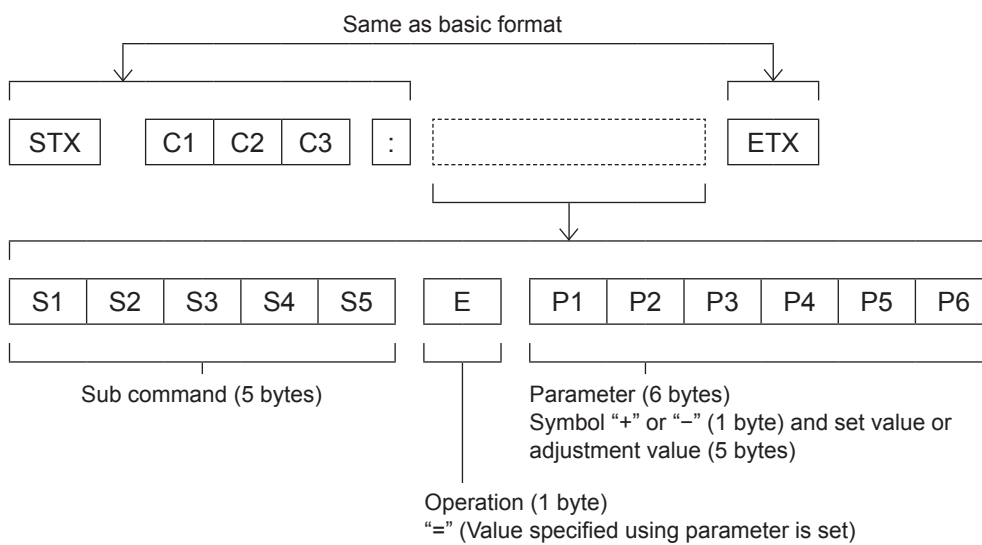

*: When transmitting a command which does not need a parameter, the operation (E) and parameter are not necessary.

■ Control commands

When controlling the projector from a computer, the following commands are available:

[Projector control command]

Command	Control contents	Remarks
PON	Power [ON]	
POF	Power [OFF]	
IIS	INPUT selection	(Parameter) VID = Video RG1 = Computer 1 RG2 = Computer 2 HD1 = HDMI
OSH	AV mute function	Turn off the projection and sound temporarily. Do not send the command consecutively. (Parameters) 0 = AV MUTE mode off 1 = AV MUTE mode on
AMT	Volume mute function	0 = OFF 1 = ON
QPW	Power query	000 = Standby 001 = Power on
Q\$\$	Lamp condition query	(Call back) 0 = Stand-by 1 = Lamp ON control active 2 = Lamp ON 3 = Lamp OFF control active

Other terminals

Pin assignments and signal names of <COMPUTER 1 IN/COMPUTER 2 IN> terminal

Outside view	Pin No.	Signal names	
	①	R/P _R	
	②	G/G · SYNC/Y	
	③	B/P _B	
	⑨	+ 5 V	
	⑫	DDC data	
	⑬	HD/SYNC	
	⑭	VD	
	⑮	DDC clock	
			④ : Not assigned
			⑤ - ⑧, ⑩, ⑪ : GND terminals

Pin assignments and signal names of <MONITOR OUT> terminal

Outside view	Pin No.	Signal names	
	①	R/P _R	
	②	G/G · SYNC/Y	
	③	B/P _B	
	⑬	HD/SYNC	
	⑭	VD	
			④, ⑨, ⑪, ⑫, ⑮ : Not assigned
			⑤ - ⑧, ⑩ : GND terminals

Pin assignments and signal names of <HDMI IN> terminal

Outside view	Pin No.	Signal names	Pin No.	Signal names
<p>Even-numbered pins ② to ⑮</p> <p>Odd-numbered pins ① to ⑲</p>	①	T.M.D.S data 2+	⑪	T.M.D.S clock shield
	②	T.M.D.S data 2 shield	⑫	T.M.D.S clock -
	③	T.M.D.S data 2-	⑬	CEC
	④	T.M.D.S data 1+	⑭	—
	⑤	T.M.D.S data 1 shield	⑮	SCL
	⑥	T.M.D.S data 1-	⑯	SDA
	⑦	T.M.D.S data 0+	⑰	DDC/CEC GND
	⑧	T.M.D.S data 0 shield	⑱	+5V
	⑨	T.M.D.S data 0-		Hot plug detection
	⑩	T.M.D.S clock +		

PJLink protocol

The network function of the projector supports PJLink class 1, and the PJLink protocol can be used to perform projector setting and projector status query operations from a computer.

Control commands

The following table lists the PJLink protocol commands that can be used to control the projector.

Command	Control details	Notes
POWR	Power supply control	Parameters 0 = Standby 1 = Power ON
POWR ?	Power supply status query	Parameters 0 = Standby 1 = Power ON 2 = Cool-down in progress 3 = Warm-up in progress
INPT	Input selection	Parameters
INPT ?	Input selection query	11 = Computer 1 12 = Computer 2 21 = VIDEO 31 = HDMI
AVMT	AV MUTE control	Parameters
AVMT ?	AV MUTE status query	30 = AV MUTE mode off 31 = AV MUTE mode on
ERST ?	Error status query	Parameters 1st byte : Indicates fan errors, range 0 – 2 2nd byte : Indicates lamp errors, range 0 – 2 3rd byte : Indicates temperature errors, range 0 – 2 4th byte : Fixed at 0 5th byte : Indicates filter errors, range 0 – 2 6th byte : Indicates other errors, range 0 – 2 Definitions for each value from 0 to 2 are as follows. 0 = No error known 1 = Warning 2 = Error
LAMP ?	Lamp status query	Parameters 1st digits (1 – 5 digits) : Lamp cumulative operating time 2nd digit : 0 = Lamp off, 1 = Lamp on
INST ?	Input selection list query	The followings are returned as parameters. "11, 12, 21, 31"
NAME ?	Projector name query	The name set for [Projector name] in [LAN Settings] is returned.
INF1 ?	Manufacturer name query	"Panasonic" is returned.
INF2 ?	Model name query	Answer the model name with "TW330EA", "TW240EA" or "TX300EA".
CLSS ?	Class information query	"1" is returned.

PJLink security authorization

The password for PJLink is the same as the password for Web Management. (➡ page 50)

When using PJLink without security authorization, set use without the password in Web Management.

For specifications regarding PJLink, refer to the Japan Business Machine and Information System Industries Association website.

<http://pjlink.jbmia.or.jp/english/>

List of compatible signals

The following table specifies the types of signals compatible with the projectors.

Format : V = VIDEO, R = RGB, Y = YP_BP_R, H = HDMI

Mode	Display resolution *1 (dots)	Scanning frequency		Dot clock frequency (MHz)	Format	Plug and play *3	
		H (kHz)	V (Hz)			COMPUTER 1/ COMPUTER 2	HDMI
NTSC/NTSC4.43/ PAL-M/PAL60	-	15.75	59.9	-	V	-	-
PAL/PAL-N/ SECAM	-	15.63	50.0	-	V	-	-
525i (480i)	720 x 480i	15.73	59.9	13.50	Y	-	-
	720(1 440) x 480i (*2)	15.73	59.9	27.00	H	-	o
625i (576i)	720 x 576i	15.63	50.0	13.50	Y	-	-
	720(1 440) x 576i (*2)	15.63	50.0	27.00	H	-	o
525p (480p)	720 x 483	31.47	59.9	27.00	Y/H	-	o
625p (576p)	720 x 576	31.25	50.0	27.00	Y/H	-	o
750 (720)/60p	1 280 x 720	45.00	60.0	74.25	Y/H	-	o
750 (720)/50p	1 280 x 720	37.50	50.0	74.25	Y/H	-	o
1125 (1080)/60i	1 920 x 1 080i	33.75	60.0	74.25	Y/H	-	o
1125 (1080)/50i	1 920 x 1 080i	28.13	50.0	74.25	Y/H	-	o
1125 (1080)/24p	1 920 x 1 080	27.00	24.0	74.25	Y/H	-	o
1125 (1080)/60p	1 920 x 1 080	67.50	60.0	148.50	Y/H	-	o
1125 (1080)/50p	1 920 x 1 080	56.25	50.0	148.50	Y/H	-	o
VGA	640 x 480	31.47	59.9	25.18	R/H	o	o
		35.00	66.7	30.24	R/H	o	o
		37.86	72.8	31.50	R/H	o	o
		37.50	75.0	31.50	R/H	o	o
		43.27	85.0	36.00	R/H	-	-
SVGA	800 x 600	35.16	56.3	36.00	R/H	o	o
		37.88	60.3	40.00	R/H	o	o
		48.08	72.2	50.00	R/H	o	o
		46.88	75.0	49.50	R/H	o	o
		53.67	85.1	56.25	R/H	-	-
MAC16	832 x 624	49.73	74.6	57.28	R/H	o	o
XGA	1 024 x 768	48.36	60.0	65.00	R/H	o	o
		56.48	70.1	75.00	R/H	o	o
		60.02	75.0	78.75	R/H	o	o
		68.68	85.0	94.50	R/H	-	-
MAC21	1 152 x 870	68.68	75.1	100.00	R/H	-	-
WXGA	1 280 x 768	47.78	59.9	79.50	R/H	-	-
		60.29	74.9	102.25	R/H	-	-
	1 280 x 720	44.77	60.0	74.50	R/H	o	o
	1 280 x 800	49.70	59.8	83.50	R/H	o	o
MSXGA	1 280 x 960	60.00	60.0	108.00	R/H	o	o
		75.20	75.0	130.00	R/H	-	-

Mode	Display resolution *1 (dots)	Scanning frequency		Dot clock frequency (MHz)	Format	Plug and play *3	
		H (kHz)	V (Hz)			COMPUTER 1/ COMPUTER 2	HDMI
SXGA	1 280 x 1 024	63.98	60.0	108.00	R/H	o	o
		79.98	75.0	135.00	R/H	o	o
		91.15	85.0	157.50	R/H	-	-
1366x768	1 366 x 768	47.72	59.8	84.75	R/H	o	o
SXGA+	1 400 x 1 050	65.32	60.0	121.75	R/H	o	o
UXGA	1 600 x 1 200	75.00	60.0	162.00	R/H	o	o

*1: "i" added to the resolution value indicates an interlaced signal.

*2: HDMI signal of 480i and 576i is only supported by 27MHz Dot clock signal.

*3: Where marked "o" signals indicates in Plug and Play is compatible with EDID of projector. Unmarked signals in Plug and Play may also be compliant if input terminals are written in the format list. Where Plug and Play is unmarked and nothing is written in the format list, difficulties in projecting image may occur even when computer and projector appear to have same resolution.

Note

- The number of display dots is 1 024 x 768 for the PT-TX300EA and 1 280 x 800 for the PT-TW330EA, PT-TW240EA. A signal with a different resolution will be projected after converting the resolution to match the projector display.
- When interlaced signals are connected, flicker may occur on the projected image.
- Even the above signals exist, some image signals that recorded in special method may not be displayed.
- The <AUTO ADJ.> operation may not optimize the image position or the resolution, depending on the input signal format or the image contents. In this case, switch to a different image and execute <AUTO ADJ.> again.
- When the detected signal is out of display range under PC source, the "Out of display range" message will display on the top left corner of the image.

Specifications

Model No.	PT-TX300EA		PT-TW330EA		PT-TW240EA	
Power supply	100 V – 240 V AC, 50/60 Hz					
Power consumption	100 V - 240 V, 3.3 A-1.3 A, 301 W				100 V - 240 V, 2.7 A-1.1 A, 254 W	
	Standby power consumption <ul style="list-style-type: none"> ● 0.5 W When [LAN (Standby)]/[VGA Out (Standby)]/[In Standby Mode (Audio)] are all set to [Off]. ● 6.0 W When one or more among [LAN (Standby)]/[VGA Out (Standby)]/[In Standby Mode (Audio)] is/are set to [On]. 					
DLP panel	Panel size	14.0 mm (0.55") (Aspect ratio 4:3)		16.5 mm (0.65") (Aspect ratio 16:10)		
	Display method	DLP™ chip × 1, DLP™ system				
	Pixels	786 432 pixels (1 024 x 768 dots)		1 024 000 pixels (1 280 x 800 dots)		
Lens	Fixed focus, (0.626:1 throw ratio) Manual focus F 2.8, f = 7.26 mm		Fixed focus, (0.521:1 throw ratio) Manual focus F 2.8, f = 7.51 mm			
Luminous lamp	240 W UHM lamp				190 W UHM lamp	
Light output *1	3 000 lm		3 100 lm		2 700 lm	
Contrast ratio*1	7 500 : 1 (all white / all black) For RGB signal input, set [Color Mode] to [Dynamic] and [Lamp Power Mode] to [Auto]					
Applicable scanning frequency *2	for Video signal	Horizontal 15.75 kHz / 15.63 kHz, Vertical 60 Hz / 50 Hz				
	for RGB signal	Horizontal 15 kHz to 91.1 kHz, Vertical 24 Hz to 85.1 Hz				
		Dot clock frequency: 162 MHz or less				
	for YP _B P _R signal	[525i(480i)]	Horizontal 15.75 kHz, Vertical 60 Hz			
		[625i(576i)]	Horizontal 15.63 kHz, Vertical 50 Hz			
[525p(480p)]		Horizontal 31.50 kHz, Vertical 60 Hz				
[625p(576p)]		Horizontal 31.25 kHz, Vertical 50 Hz				
[750(720)/60p]		Horizontal 45.00 kHz, Vertical 60 Hz				
[750(720)/50p]	Horizontal 37.50 kHz, Vertical 50 Hz					
[1125(1080)/60i]	Horizontal 33.75 kHz, Vertical 60 Hz					
[1125(1080)/50i]	Horizontal 28.13 kHz, Vertical 50 Hz					
[1125(1080)/24p]	Horizontal 27.00 kHz, Vertical 24 Hz					
[1125(1080)/60p]	Horizontal 67.50 kHz, Vertical 60 Hz					
[1125(1080)/50p]	Horizontal 56.25 kHz, Vertical 50 Hz					
for HDMI signal	525i(480i), 625i(576i), 525p(480p), 625p(576p), 750(720)/60p, 750(720)/50p, 1125(1080)/60i, 1125(1080)/50i, 1125(1080)/24p, 1125(1080)/60p, 1125(1080)/50p <ul style="list-style-type: none"> ● Displayable resolution: VGA to UXGA (non-interlace) ● Dot clock frequency: 25 MHz ~ 162 MHz 					
Color system	7 (NTSC, NTSC4.43, PAL, PAL-N, PAL-M, SECAM, PAL60)					
Projection size	40"-200" *3		50"-200" *3			
Screen aspect ratio	4:3		16:10			
Projection scheme	Front / Rear / Mount on Ceiling / Floor (Menu setting system)					
Speaker	1 (7.1 cm x 4.1 cm)					
Maximum usable volume output	8 W					

*1 : Measurement, measuring conditions and method of notation all comply with ISO21118 international standards.

*2 : For details of video signals that can be projected using this projector, refer to "List of compatible signals". (► pages 66-67)

*3 : The value of native aspect ratio (4:3 for PT-TX300EA; 16:10 for PT-TW330EA and PT-TW240EA).

Specifications

Model No.		PT-TX300EA	PT-TW330EA	PT-TW240EA
Terminals	COMPUTER 1 IN / COMPUTER 2 IN	2 sets, high-density D-Sub 15p (female) [RGB signal] 0.7 V [p-p] 75 Ω (When G-SYNC: 1.0 V [p-p] 75 Ω) HD/SYNC TTL high impedance, automatic positive/negative polarity compatible VD TTL high impedance, automatic positive/negative polarity compatible SYNC/HD and VD are not compliant with 3 value composite SYNC [Y _P B _P R signal] Y: 1.0 V [p-p] including synchronization signal, P _B P _R : 0.7 V [p-p] 75 Ω		
	MONITOR OUT	1 set, high-density D-Sub 15p (female) [RGB signal] 0.7 V [p-p] 75 Ω (When G-SYNC: 1.0 V [p-p] 75 Ω) HD/SYNC TTL high impedance VD TTL high impedance [Y _P B _P R signal] Y: 1.0 V [p-p] including synchronization signal, P _B P _R : 0.7 V [p-p] 75 Ω		
	VIDEO	1 (Pin jack 1.0 V [p-p] 75 Ω)		
	HDMI	1 (HDMI 19 pin, HDCP and Deep color compatible)		
	AUDIO 1 IN	2 (M3 stereo mini jack, 0.5 V [rms], input impedance 22 kΩ and more)		
	AUDIO 2 IN			
	VARIABLE AUDIO OUT	1 (M3 stereo mini jack, stereo monitor output compatible, 0 V [rms] to 2.0 V [rms] variable, output impedance 2.2 kΩ and less)		
	SERIAL IN	1 (D-sub 9 pin, RS-232C compliant, for computer control use)		
	LAN	1 (For RJ-45 network connection: PLink (class 1) compatible)		
Power cable length		3.0 m (118.11")		
Cabinet		Molded plastic		
Dimensions		Width: 288.0 mm (11.34") Height: 99.8 mm (3.93") (when adjustable feet shortened) Depth: 246.7 mm (9.71")	Width: 288.0 mm (11.34") Height: 99.8 mm (3.93") (when adjustable feet shortened) Depth: 246.8 mm (9.72")	
Weight		Approx. 2.5 kg (5.5 lbs.) *4		
Noise level *5		When set to [Normal] in [Lamp power mode]: 37 dB When set to [ECO2] in [Lamp power mode]: 29 dB	When set to [Normal] in [Lamp power mode]: 35 dB When set to [ECO] in [Lamp power mode]: 29 dB	
Operating environment		Operating environment temperature: 5 °C to 40 °C (For 0 - 2 500 ft), (Elevation: below approx. 750 m); 5 °C to 35 °C (For 2 500 - 5 000 ft), (Elevation: approx. 750 m - approx. 1 500 m); 5 °C to 30 °C (For 5 000 - 10 000 ft), (Elevation: approx. 1 500 m - approx. 3 000 m); Operating environment humidity: 20 % to 80 % (no condensation)		
Remote control	Power supply	DC 3 V (Lithium coin battery)		
	Operating range	Approx. 8 m (26.25 ft) (when operated directly in front of signal receiver)		
	Weight	23 g (0.81 ozs.) (including battery)		
	Dimensions	Width : 40.6 mm (1.60"), Length : 86.5 mm (3.41"), Height : 7.2 mm (0.28")		

*4 : This is an average value. It may differ depending on individual product.

*5 : Measurement, measuring conditions and method of notation all comply with ISO21118 international standards.

- The part numbers of accessories and separately sold components are subject to change without notice.

Specifications

Dimensions

<Unit : mm (inch)>

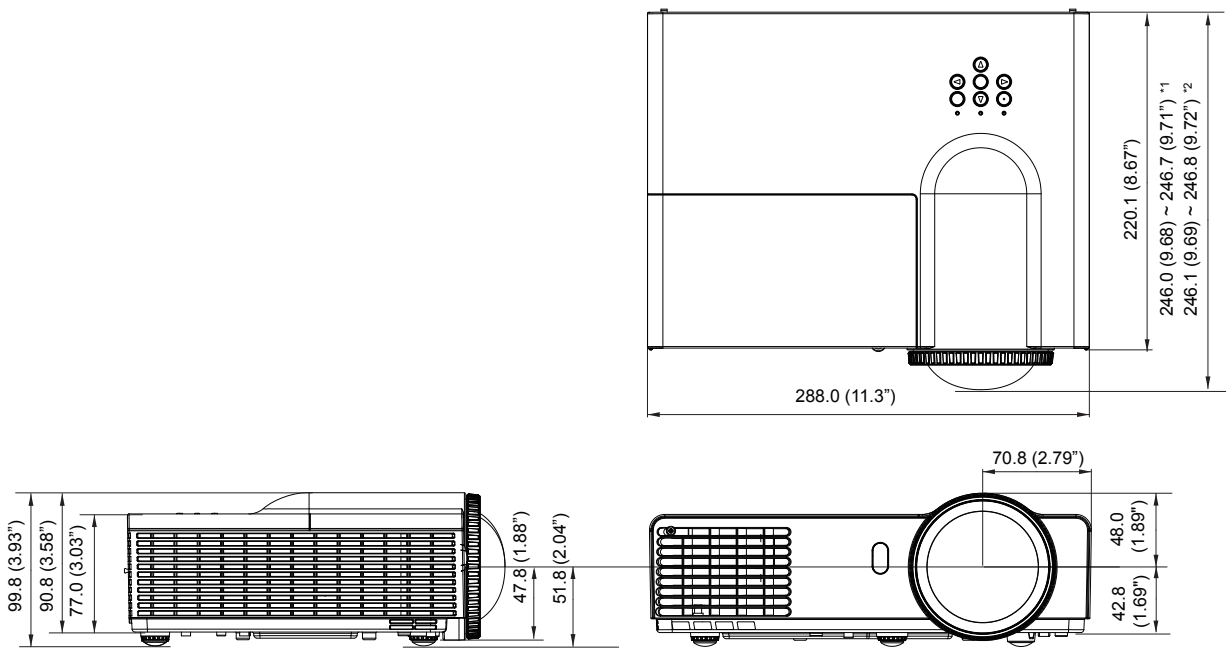

*1: PT-TX300EA

*2: PT-TW330EA, PT-TW240EA

* : Actual dimension may differ by product.

Ceiling mount bracket safeguards

- Installation work of the ceiling mount bracket should only be carried by a qualified technician.
- Even if it is during guaranteed period, the manufacturer is not responsible for any hazard or damage caused by using a ceiling mount bracket which is not purchased from an authorized distributors, or environmental conditions.
- Remove an unused ceiling mount bracket promptly.
- Ensure to use a torque driver and do not use an electrical screwdriver or an impact screwdriver.
- For details, see the work instruction manual packed together with the ceiling mount bracket.
- The model Nos. of the accessories and the parts sold separately are subject to change without notice.
- Make sure the screws on the ceiling mount kit cannot touch the metal parts materials (metallic lath, wire or board) in the ceiling board. Otherwise it may result in fire hazard.

Bottom view

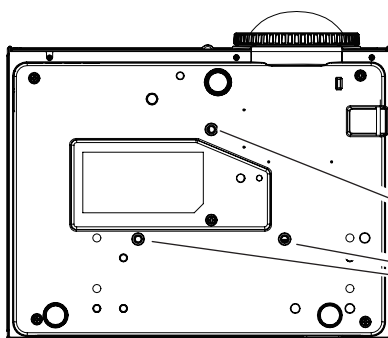

Model No. of ceiling mount bracket:

ET-PKV100H (for high ceilings)

ET-PKV100S (for low ceilings)

Model No. of projector mount bracket:

ET-PKL300B

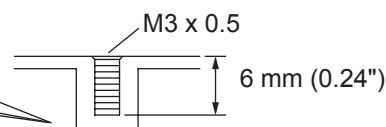

Torque: $0.8 \pm 0.1 \text{ N} \cdot \text{m}$

Index

A		
About Your Projector.....	16	
Accessories.....	15	
Adjusting the Projector's Height.....	24	
Aspect Ratio.....	38	
Auto Power Off (Min).....	43	
B		
Basic operations by using the remote control.....	31	
Before cleaning/replacing the unit.....	53	
Before connecting to the projector.....	25	
Brightness.....	36	
C		
Cautions on use.....	14	
Cautions when installing.....	12	
Cautions when transporting.....	12	
Ceiling Mount.....	39	
Ceiling mount bracket safeguards.....	70	
Clock.....	38	
Closed Caption.....	40	
Color Mode.....	36	
Color Space.....	37	
Color Temp.....	37	
Computer operation via network.....	48	
Connecting example: Computers.....	26	
Connecting terminals.....	19	
Connecting the power cord.....	27	
Connections.....	25	
Connect to Network.....	47	
Contrast.....	36	
Control panel.....	18	
Crestron RoomView Control Tool.....	51	
D		
DHCP.....	45	
Digital Zoom.....	39	
Dimensions.....	70	
Disposal.....	13	
DNS.....	45	
Dust Filter Reminder.....	44	
F		
FREEZE.....	32	
G		
Gamma.....	37	
Gateway.....	45	
H		
High Altitude.....	44	
How to adjust the state of the image.....	30	
H Position.....	38	
Hue.....	37	
I		
ID numbers.....	20	
Image select.....	40	
Information.....	44	
Input.....	43	
Installing and Removing battery.....	20	
In standby mode.....	42	
IP Address.....	45	
L		
Lamp Settings.....	43	
Lamp unit.....	56	
Language.....	40	
LAN (Standby).....	41	
List of compatible signals.....	66	
M		
Maintenance/replacement.....	53	
Menu Location.....	40	
Menu Tree.....	34	
Mute.....	42	
O		
ON(G)/STANDBY(R) indicator.....	28	
Optional accessories.....	15	
Other terminals.....	64	
P		
Phase.....	38	
PJLink protocol.....	65	
Powering Off the Projector.....	29	
Powering On the Projector.....	29	
Precautions for Use.....	12	
Projection method.....	21	
Projector body.....	17	
R		
Read this first!.....	2	
Real.....	36	
Remote control.....	16	
Remote ID.....	41	
Replacing the Lamp unit.....	57	
Replacing the unit.....	55	
Reset.....	41, 46	
S		
Saturation.....	37	
Screen size and throw distance.....	22	
Security.....	13	
Selecting the input signal.....	30	
Serial terminal.....	61	
Setting the ID number.....	20	
Setting up.....	21	
Sharpness.....	36	
Specifications.....	68	
Startup Logo.....	41	
Store.....	46	
Subnet Mask.....	45	
Switching the input signal.....	31	
T		
Test Pattern.....	40	
Troubleshooting.....	58	
U		
UART Mode.....	41	
V		
VGA Out (Standby).....	40	
V Keystone.....	39	
Volume.....	42	
V Position.....	39	
W		
Wall color.....	36	
Web Management.....	48	

Information for Users on Collection and Disposal of Old Equipment and used Battery



These symbols on the products, packaging, and/or accompanying documents mean that used electrical and electronic products and battery should not be mixed with general household waste. For proper treatment, recovery and recycling of old products and used battery, please take them to applicable collection points, in accordance with your national legislation and the Directives 2002/96/EC and 2006/66/EC.

By disposing of these products and battery correctly, you will help to save valuable resources and prevent any potential negative effects on human health and the environment which could otherwise arise from inappropriate waste handling.



For more information about collection and recycling of old products and battery, please contact your local municipality, your waste disposal service or the point of sale where you purchased the items.

Penalties may be applicable for incorrect disposal of this waste, in accordance with national legislation.



For business users in the European Union

If you wish to discard electrical and electronic equipment, please contact your dealer or supplier for further information.

Information on Disposal in other Countries outside the European Union

These symbols are only valid in the European Union. If you wish to discard these items, please contact your local authorities or dealer and ask for the correct method of disposal.

Note for the battery symbol (bottom two symbol examples):

This symbol might be used in combination with a chemical symbol. In this case it complies with the requirement set by the Directive for the chemical involved.