

Panasonic®

Operating Instructions Functional Manual

LCD Projector Commercial Use

Model No. **PT-LZ370EA**

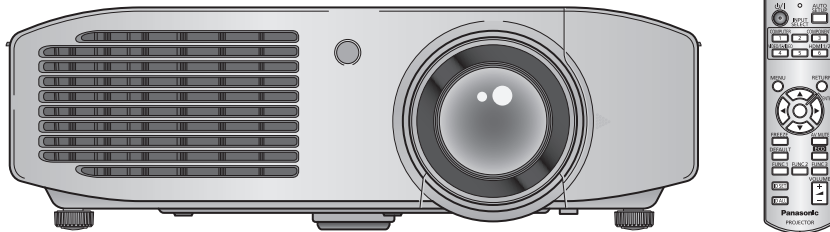

Thank you for purchasing this Panasonic product.

- Before operating this product, please read the instructions carefully and save this manual for future use.
- Before using your projector, be sure to read “Read this first!” (➡ pages 2 to 8).

ENGLISH

TQBJ0413

Read this first!

WARNING: THIS APPARATUS MUST BE EARTHED.

WARNING: To prevent damage which may result in fire or shock hazard, do not expose this appliance to rain or moisture.

Machine Noise Information Ordinance 3. GSGV, January 18, 1991: The sound pressure level at the operator position is equal or less than 70 dB (A) according to ISO 7779.

WARNING:

1. Remove the plug from the mains socket when this unit is not in use for a prolonged period of time.
2. To prevent electric shock, do not remove cover. No user serviceable parts inside. Refer servicing to qualified service personnel.
3. Do not remove the earthing pin on the mains plug. This apparatus is equipped with a three prong earthingtype mains plug. This plug will only fit an earthing-type mains socket. This is a safety feature. If you are unable to insert the plug into the mains socket, contact an electrician. Do not defeat the purpose of the earthing plug.

CAUTION: To assure continued compliance, follow the attached installation instructions, which include using the provided power cord and shielded interface cables when connecting to computer or peripheral device. If you use serial port to connect PC for external control of projector, you must use optional RS-232C serial interface cable with ferrite core. Any unauthorized changes or modifications to this equipment will void the user's authority to operate.

IMPORTANT: THE MOULDED PLUG (U.K. only)

FOR YOUR SAFETY, PLEASE READ THE FOLLOWING TEXT CAREFULLY.

This appliance is supplied with a moulded three pin mains plug for your safety and convenience. A 13 amp fuse is fitted in this plug. Should the fuse need to be replaced, please ensure that the replacement fuse has a rating of 13 amps and that it is approved by ASTA or BSI to BS1362.

Check for the ASTA mark  or the BSI mark  on the body of the fuse.

If the plug contains a removable fuse cover, you must ensure that it is refitted when the fuse is replaced. If you lose the fuse cover, the plug must not be used until a replacement cover is obtained. A replacement fuse cover can be purchased from an Authorised Service Center.

If the fitted moulded plug is unsuitable for the mains socket in your home, then the fuse should be removed and the plug cut off and disposed of safely. There is a danger of severe electrical shock if the cut off plug is inserted into any 13 amp socket.

If a new plug is to be fitted, please observe the wiring code as shown below.
If in any doubt, please consult a qualified electrician.

WARNING: THIS APPLIANCE MUST BE EARTHED.

IMPORTANT: The wires in this mains lead are coloured in accordance with the following code:

Green - and - Yellow:	Earth
Blue:	Neutral
Brown:	Live

As the colours of the wire in the mains lead of this appliance may not correspond with the coloured markings identifying the terminals in your plug, proceed as follows.

The wire which is coloured GREEN - AND - YELLOW must be connected to the terminal in the plug which is marked with the letter E or by the Earth symbol  or coloured GREEN - AND - YELLOW.

The wire which is coloured BLUE must be connected to the terminal in the plug which is marked with the letter N or coloured BLACK.

The wire which is coloured BROWN must be connected to the terminal in the plug which is marked with the letter L or coloured RED.

How to replace the fuse: Open the fuse compartment with a screwdriver and replace the fuse.

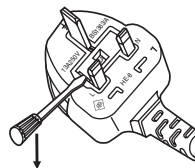

Read this first!

WARNING:

■ POWER

The wall outlet or the circuit breaker shall be installed near the equipment and shall be easily accessible when problems occur. If the following problems occur, cut off the power supply immediately.

Continued use of the projector in these conditions will result in fire or electric shock.

- If foreign objects or water get inside the projector, cut off the power supply.
 - If the projector is dropped or the cabinet is broken, cut off the power supply.
 - If you notice smoke, strange smells or noise coming from the projector, cut off the power supply.
- Please contact an Authorized Service Center for repairs, and do not attempt to repair the projector yourself.

During a thunderstorm, do not touch the projector or the cable.

Electric shocks can result.

Do not do anything that might damage the power cord or the power plug.

If the power cord is used while damaged, electric shocks, short-circuits or fire will result.

- Do not damage the power cord, make any modifications to it, place it near any hot objects, bend it excessively, twist it, pull it, place heavy objects on top of it or wrap it into a bundle.

Ask an Authorized Service Center to carry out any repairs to the power cord that might be necessary.

Completely insert the power plug into the wall outlet and the power connector into the projector terminal.

If the plug is not inserted correctly, electric shocks or overheating will result.

- Do not use plugs which are damaged or wall outlets which are coming loose from the wall.

Do not use anything other than the provided power cord.

Failure to observe this will result in electric shocks or fire.

Clean the power plug regularly to prevent it from becoming covered in dust.

Failure to observe this will cause a fire.

- If dust builds up on the power plug, the resulting humidity can damage the insulation.
- If not using the projector for an extended period of time, pull the power plug out from the wall outlet.

Pull the power plug out from the wall outlet and wipe it with a dry cloth regularly.

Do not handle the power plug and power connector with wet hands.

Failure to observe this will result in electric shocks.

Do not overload the wall outlet.

If the power supply is overloaded (ex., by using too many adapters), overheating may occur and fire will result.

■ ON USE/INSTALLATION

Do not place the projector on soft materials such as carpets or sponge mats.

Doing so will cause the projector to overheat, which can cause burns, fire or damage to the projector.

Do not set up the projector in humid or dusty places or in places where the projector may come into contact with oily smoke or steam, ex. a bathroom.

Using the projector under such conditions will result in fire, electric shocks or deterioration of components.

Deterioration of components (such as ceiling mount brackets) may cause the projector which is mounted on the ceiling to fall down.

Do not install this projector in a place which is not strong enough to take the full weight of the projector or on top of a surface which is sloped or unstable.

Failure to observe this will cause projector to fall down or tip over the projector, and severe injury or damage could result.

WARNING:**Do not cover the air intake/exhaust ports or place anything within 100 mm (4") of them.**

Doing so will cause the projector to overheat, which can cause fire or damage to the projector.

- Do not place the projector in narrow, badly ventilated places.
- Do not place the projector on cloth or papers, as these materials could be drawn into the air intake port.

Do not place your hands or other objects close to the air exhaust port.

Doing so will cause burns or damage your hands or other objects.

- Heated air comes out of the air exhaust port. Do not place your hands or face, or objects which cannot withstand heat close to this port.

Do not look and place your skin into the lights emitted from the lens while the projector is being used.

Doing so can cause burns or loss of sight.

- Strong light is emitted from the projector's lens. Do not look or place your hands directly into this light.
- Be especially careful not to let young children look into the lens. In addition, turn off the power and disconnect the power plug when you are away from the projector.

Never attempt to remodel or disassemble the projector.

High voltages can cause fire or electric shocks.

- For any inspection, adjustment and repair work, please contact an Authorized Service Center.

Do not project an image with the lens cover attached.

Doing so can cause fire.

Do not allow metal objects, flammable objects, or liquids to enter inside of the projector. Do not allow the projector to get wet.

Doing so may cause short circuits or overheating, and result in fire, electric shock, or malfunction of the projector.

- Do not place containers of liquid or metal objects near the projector.
- If liquid enters inside of the projector, consult your dealer.
- Particular attention must be paid to children.

Use the ceiling mount bracket specified by Panasonic.

Defects in the ceiling mount bracket will result in falling accidents.

- Attach the supplied safety cable to the ceiling mount bracket to prevent the projector from falling down.

Installation work (such as ceiling mount bracket) should only be carried out by a qualified technician.

If installation is not carried out and secured correctly it can cause injury or accidents, such as electric shocks.

- Do not use anything other than an authorized ceiling mount bracket.
- Be sure to use the provided accessory wire with an eye bolt as an extra safety measure to prevent the projector from falling down. (Install in a different location to the ceiling mount bracket)

Read this first!

WARNING:

■ ACCESSORIES

Do not use or handle the batteries improperly, and refer to the following.

Failure to observe this will cause burns, batteries to leak, overheat, explode or catch fire.

- Do not use unspecified batteries.
- Do not disassemble dry cell batteries.
- Do not heat the batteries or place them into water or fire.
- Do not allow the + and – terminals of the batteries to come into contact with metallic objects such as necklaces or hairpins.
- Do not store batteries together with metallic objects.
- Store the batteries in a plastic bag and keep them away from metallic objects.
- Make sure the polarities (+ and –) are correct when inserting the batteries.
- Do not use a new battery together with an old battery or mix different types of batteries.
- Do not use batteries with the outer cover peeling away or removed.

If the battery fluid leaks, do not touch it with bare hands, and take the following measures if necessary.

- Battery fluid on your skin or clothing could result in skin inflammation or injury.
Rinse with clean water and seek medical advice immediately.
- Battery fluid coming in contact with your eyes could result in loss of sight.
In this case, do not rub your eyes. Rinse with clean water and seek medical advice immediately.

Do not disassemble the lamp unit.

If the lamp breaks, it could cause injury.

Lamp replacement

The lamp has high internal pressure. If improperly handled, an explosion and severe injury or accidents will result.

- The lamp can easily explode if struck against hard objects or dropped.
- Before replacing the lamp, be sure to disconnect the power plug from the wall outlet.
Electric shocks or explosions can result if this is not done.
- When replacing the lamp, turn the power off and allow the lamp to cool for at least one hour before handling it otherwise it can cause burns.

Do not allow infants or pets to touch the remote control unit.

- Keep the remote control unit out of the reach of infants and pets after using it.

Do not use the supplied power cord with devices other than this projector.

- Using the supplied power cord with devices other than this projector may cause short circuits or overheating, and result in electric shock or fire.

Remove the depleted batteries from the remote control promptly.

- Leaving them in the unit may result in fluid leakage, overheating, or explosion of the batteries.

CAUTION:

■ POWER

When disconnecting the power cord, be sure to hold the power plug and power connector.

If the power cord itself is pulled, the lead will become damaged, and fire, short-circuits or serious electric shocks will result.

When not using the projector for an extended period of time, disconnect the power plug from the wall outlet and remove the batteries from the remote control.

Failure to do so may result in fire or electric shock.

Disconnect the power plug from the wall outlet before carrying out cleaning the unit.

Failure to do so may result in electric shock.

CAUTION:

■ **ON USE/INSTALLATION**

Do not place heavy objects on top of the projector.

Failure to observe this will cause the projector to become unbalanced and fall, which could result in damage or injury. The projector will be damaged or deformed.

Do not put your weight on this projector.

You could fall or the projector could break, and injury will result.

- Be especially careful not to let young children stand or sit on the projector.

Do not place the projector in extremely hot locations.

Doing so will cause the outer casing or internal components to deteriorate, or result in fire.

- Take particular care in locations exposed to direct sunlight or near stoves.

Always disconnect all cables before moving the projector.

Moving the projector with cables still attached can damage the cables, which will cause fire or electric shocks to occur.

■ **ACCESSORIES**

Do not use the old lamp unit.

If used it could cause lamp explosion.

If the lamp has broken, ventilate the room immediately. Do not touch or bring your face close to the broken pieces.

Failure to observe this will cause the user to absorb the gas which was released when the lamp broke and which contains nearly the same amount of mercury as fluorescent lamps, and the broken pieces will cause injury.

- If you believe that you have absorbed the gas or that the gas has got into your eyes or mouth, seek medical advice immediately.
- Ask your dealer about replacing the lamp unit and check the inside of the projector.

Read this first!



To remove the battery

Remote Control Battery

1. Press the guide and lift the cover.

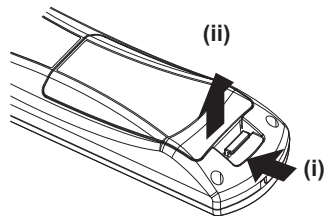

2. Remove the batteries.

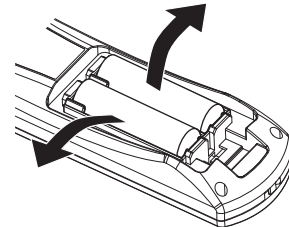

Trademarks

- Microsoft® and its logos, Windows®, Windows® XP, Windows Vista®, Windows® 7, and Internet Explorer® are the registered trademarks or trademarks of Microsoft Corporation in the United States and/or other countries.
- Macintosh, Mac OS and Safari are the trademarks of Apple Inc. registered in the United States and other countries.
- PJLink™ is a trademark or pending trademark in Japan, the United States, and other countries and regions.
- HDMI, the HDMI logo and High-Definition Multimedia Interface are trademarks or registered trademarks of HDMI Licensing LLC.
- VGA and XGA are trademarks of International Business Machines Corporation.
- SVGA is a registered trademark of the Video Electronics Standards Association.
- RoomView, Crestron RoomView, and Crestron Connected are trademarks of Crestron Electronics, Inc.
- The font used in the on-screen displays is a Ricoh bitmap font, which is manufactured and sold by Ricoh Company, Ltd.
- Adobe Flash Player is either a trademark or registered trademark of Adobe Systems Incorporated in the United States and/or other countries.
- Other names, company names or product names used in these operating instructions are the trademarks or registered trademarks of their respective holders.
Please note that the operating instructions do not include the ® and TM symbols.

Illustrations in these operating instructions

- Note that illustrations of the projector and screens may differ from the ones you actually see.

Page references

- In these instructions, references to pages are indicated as: (➡ page 00).

Term

- In these instructions, the “Wireless remote control unit” accessory is referred to as the “Remote control”.

Features of the Projector

Easy setup and improved serviceability

- ▶ The 2x zoom lens and the lens shift allow more flexible setup of the projector.

Improved color reproducibility and contrast

- ▶ A new lamp and optical system have been introduced to improve color reproducibility and contrast.

Harmonization with projection environment

- ▶ This projector is equipped with technology to automatically adjust the image according to the lighting of the projection environment (brightness, color).

Quick Steps

For details, see the corresponding pages.

1. **Set up your projector.**
(➡ page 23)



2. **Connect with other devices.**
(➡ page 30)



3. **Connect the power cord.**
(➡ page 33)



4. **Switch on the projector.**
(➡ page 35)



5. **Make initial settings.*1**
(➡ page 18)



6. **Select the input signal.**
(➡ page 37)



7. **Adjust the image.**
(➡ page 37)

*1: This is the step to be taken when you switch on the power for the first time after purchase.

Important Information

Read this first!	2
Precautions for use	12
Cautions when transporting	12
Cautions when installing	12
Security	14
Disposal	14
Cautions on use	15
Accessories	16
Optional accessories	17

Preparation

Start-up display	18
About your projector	19
Remote control	19
Projector body	20
Using Remote control	22
Inserting and removing the batteries	22
Setting Remote control ID numbers	22

Getting Started

Setting up	23
Projection method	23
Parts for ceiling mount (optional)	23
Screen size and throw distance	24
Adjusting adjustable feet	26
Lens shift and positioning	26
Connections	30
Before connecting to the projector	30
Connecting example: Input terminals	31

Basic Operation

Switching on/off	33
Connecting the power cord	33
Power indicator	34
Switching on the projector	35
Switching off the projector	36
Direct power off function	36
Projecting	37
Selecting the input signal	37
Adjusting the image	37
Remote control operation	39
Using the AV mute function	39
Using the Freeze function	39
Switching the input	40
Using the Automatic setup function	40
Using the Function button	41

Using the ECO management function	41
Resetting to the factory default	41
Adjusting the volume	41

Settings

Menu navigation	42
Navigating through the menu	42
Main menu	44
Sub menu	44
[PICTURE] menu	46
[PICTURE MODE]	46
[CONTRAST]	46
[BRIGHTNESS]	47
[COLOR]	47
[TINT]	47
[SHARPNESS]	47
[COLOR TEMPERATURE]	47
[DYNAMIC IRIS]	48
[WAVEFORM MONITOR]	48
[ADVANCED MENU]	51
[DAYLIGHT VIEW]	52
[DIGITAL CINEMA REALITY]	52
[NOISE REDUCTION]	52
[TV-SYSTEM]	53
[RGB/YC _B Cr]/[RGB/YP _B Pr]	53
[POSITION] menu	54
[KEystone]	54
[SHIFT]	54
[DOT CLOCK]	55
[CLOCK PHASE]	55
[OVER SCAN]	56
[ASPECT]	56
[FRAME LOCK]	58
[LANGUAGE] menu	59
Changing the display language	59
[DISPLAY OPTION] menu	60
[ON-SCREEN DISPLAY]	60
[HDMI SIGNAL LEVEL]	61
[CLOSED CAPTION SETTING]	61
[STARTUP LOGO]	62
[AUTO SETUP SETTING]	62
[SIGNAL SEARCH]	62
[BACK COLOR]	63
[SXGA MODE]	63
[OTHER FUNCTIONS]	63
[PROJECTOR SETUP] menu	64
[STATUS]	64
[PROJECTOR ID]	64
[INITIAL START UP]	65
[PROJECTION METHOD]	65

[HIGH ALTITUDE MODE]	65	Ceiling mount bracket safeguards	118
[LAMP POWER]	66	Index	119
[LAMP RUNTIME]	66		
[SCHEDULE]	66		
[ECO MANAGEMENT]	67		
[EMULATE]	69		
[FUNCTION BUTTON]	69		
[AUDIO SETTING]	70		
[DATE AND TIME]	71		
[TEST PATTERN]	72		
[INITIALIZE ALL]	72		
[SECURITY] menu	73		
[PASSWORD]	73		
[PASSWORD CHANGE]	73		
[DISPLAY SETTING]	74		
[TEXT CHANGE]	74		
[MENU LOCK]	74		
[MENU LOCK PASSWORD]	75		
[CONTROL DEVICE SETUP]	75		
[NETWORK] menu	76		
[WIRED LAN]	76		
[NAME CHANGE]	76		
[NETWORK CONTROL]	77		
[STATUS]	77		
[INITIALIZE]	77		
Network connections	78		
Required environment for computer connection	78		
Network settings of computer	79		
Accessing from the Web browser	79		
Maintenance			
<LAMP> and <TEMP> indicators	95		
Managing the indicated problems	95		
Maintenance/replacement	97		
Before maintaining/replacing the unit	97		
Maintenance	97		
Replacing the unit	99		
Troubleshooting	105		
Appendix			
Technical information	107		
PJLink protocol	107		
Control commands via LAN	108		
<SERIAL> terminal	111		
Menu lock password	113		
List of compatible signals	114		
Specifications	116		
Dimensions	118		

Precautions for use

■ Be sure to use the projector after removing the packaging material, such as the fastening tapes and protective sheet.

Take proper care when disposing of the removed packaging material.

Cautions when transporting

- When transporting the projector, be sure to attach the supplied lens cover to the projection lens.
- When transporting the projector, hold it securely by its bottom and avoid excessive vibration and impacts. Doing so may damage the internal parts and result in malfunctions.
- Do not transport the projector with the adjustable feet extended. Doing so may damage the adjustable feet.

Cautions when installing

■ Do not set up the projector outdoors.

The projector is designed for indoor use only.

■ Do not use under the following conditions.

- Places where vibration and impacts occur such as in a car or vehicle: Doing so may damage the internal parts and result in malfunctions.
- Near the exhaust of an air conditioner: Depending on the conditions of use, the screen may fluctuate due to the hot air from the air exhaust port or the heated or cooled air from the air conditioner. Take care so that the exhaust from the projector or other equipment, or the air from the air conditioner does not blow toward the front of the projector.
- Near lights (studio lamps, etc.) where temperature changes greatly (“Operating environment” (➡ page 117)): Doing so may shorten the life of the lamp or result in deformation of the outer case and malfunctions.
- Near high-voltage power lines or near motors: Doing so may interfere with the operation of the projector.

■ Be sure to ask a specialized technician when installing the product to a ceiling.

If the product is to be installed hanging from the ceiling, purchase an optional Ceiling Mount Attachment. Model No.: ET-PKA110H (for high ceilings), ET-PKA110S (for low ceilings)

■ Lens focus

The high clarity projection lens is thermally affected by the light from the light source, making the focus unstable in the period just after switching on the power. Wait at least 30 minutes with the image projected before adjusting the lens focus.

■ Make sure to set [HIGH ALTITUDE MODE] to [ON] when using the projector at elevations of 1 400 m (4 593 ft) or higher and lower than 2 700 m (8 858 ft) above sea level.

Failure to do so may shorten the life of the internal parts and result in malfunctions.

■ Make sure to set [HIGH ALTITUDE MODE] to [OFF] when using the projector at elevations lower than 1 400 m (4 593 ft) above sea level.

Failure to do so may shorten the life of the internal parts and result in malfunctions.

■ Do not install the projector at elevations of 2 700 m (8 858 ft) or higher above sea level.

Failure to do so may shorten the life of the internal parts and result in malfunctions.

Do not tilt the projector or place it on its side.

Do not tilt the projector body more than approximately $\pm 30^\circ$ vertically or $\pm 10^\circ$ horizontally. Overtilting may result in shortening the life of the components.

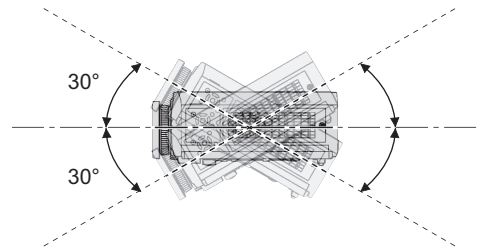

Do not cover the air intake/exhaust ports or place anything within 100 mm (4") of them.

Avoid using the projector at places where there are higher static electricity levels as far as possible.

- When using the projector in places such as on a carpet where there are static electricity, communication using wired LAN may be distorted.
In such cases, remove the source of static electricity or noise and connect wired LAN again.
- In rare cases, communication via LAN may not be possible due to static electricity or noise.
In such cases, press the power <⏻/|> button on the remote control or control panel to turn off the power of the projector.
After the cooling fan is stopped (after the power indicator <ON (G)/STANDBY (R)> of the projector body that is illuminating orange changes the indication to illuminate or flash red), turn on the power and connect to the LAN again.

Cautions when setting the projectors

- Do not stack the projectors.
- Avoid heating and cooling air from the air conditioning system directly blow to the ventilation ports (intake and exhaust) of the projector.
- Do not block the ventilation ports (intake and exhaust) of the projector.

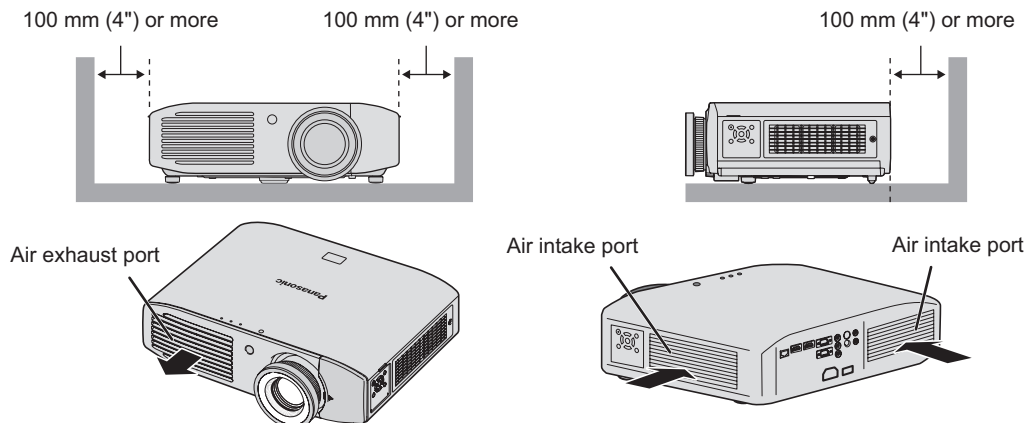

Precautions for use

- Do not install the projector in a confined space.
When it is necessary to install in a confined space, use air conditioning or ventilation separately. Exhaust heat may accumulate when the ventilation is not enough, triggering the protection circuit of the projector.
- Use the adjustable feet only for the floor standing installation and for adjusting the angle. If you use it other than this purpose, the projector may be damaged.

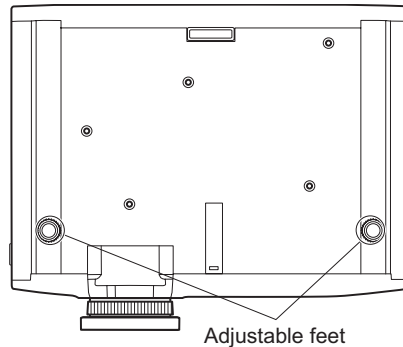

Security

Take safety measures against following incidents.

- Personal information being leaked via this product
- Unauthorized operation of this product by a malicious third party
- Interfering or stopping of this product by a malicious third party

Take sufficient security measures. (➔ page 73)

- Make your password as difficult to guess as possible.
- Change your password periodically.
- Panasonic Corporation or its affiliate company never inquires a password directly to a customer. Do not tell your password in case you receive such an inquiry.
- The connecting network must be secured by firewall or others.
- Set a password and restrict the users who can log in.

Disposal

To dispose of the product, inquire your local authorities or dealer for correct methods of disposal.

The lamp contains mercury. When disposing of used lamp units, contact your local authorities or dealer for correct methods of disposal.

Cautions on use

In order to get the picture quality

- Draw curtains or blinds over windows and turn off any lights near the screen to prevent outside light or light from indoor lamps from shining onto the screen, in order to obtain high-quality images with higher contrast.
- Depending on the conditions of use, the screen may fluctuate due to the hot air from the air exhaust port or the heated or cooled air from the air conditioner.
Take care so that the exhaust from the projector or other equipment, or the air from the air conditioner does not blow toward the front of the projector.
- The projection lens is thermally affected by the light from the light source, making the focus unstable in the period just after switching on. Focus stabilizes 30 minutes after video projection starts.

Do not touch the surface of the projection lens with your bare hands.

If the surface of the lens becomes dirty from fingerprints or anything else, this will be magnified and projected onto the screen. Please put the lens cover (accessory) on the projector when you do not use it.

LCD panel

The LCD panel is precision-made. Note that in rare cases, pixels of high precision could be missing or always lit. This is not a malfunction.

Also, projecting a still image for extended periods of time may lead to afterimages on LCD panels. Please be aware that in some cases these afterimages may not disappear completely.

Optical components

If using in an environment with a high temperature, or where dust or tobacco smoke is present, the replacement cycle of optical components such as LCD panels and polarizing plates may shorten even after less than one year of use. For more details, please consult your dealer.

Lamp

The luminous source of the projector is a mercury lamp with high internal pressure.

A high pressure mercury lamp has following characteristics.

- The brightness of the lamp will decrease by duration of usage.
- The lamp may burst with sound or shorten life by shock or chipping.
- The life of the lamp varies greatly depending on individual specificities and usage conditions. In particular, continuous use over 12 hours and frequent on/off switching of the power greatly deteriorate the lamp and affect the lamp life.
- In rare cases, the lamp burst shortly after the projection.
- The risk of bursting increases when the lamp is used beyond its replacement cycle. Make sure to replace the lamp unit consistently.
(When to replace the lamp unit (➡ page 101), Replacing the lamp unit (➡ page 102))
- If the lamp bursts, gas contained inside of the lamp is released in a form of smoke.
- It is recommended to store replacement lamps for contingency.

<Software information regarding this product>

© Panasonic Corporation 2011

This product incorporates the following software:

- (1) the software which is developed independently by or for Panasonic Corporation
- (2) the software which is licensed under the GNU GENERAL PUBLIC LICENSE. and
- (3) the software which is licensed under the GNU LESSER GENERAL PUBLIC LICENSE.

For the software categorized as (2) and (3), the license is available in accordance with GNU GENERAL PUBLIC LICENSE and GNU LESSER GENERAL PUBLIC LICENSE respectively. As for the terms and conditions, please refer to the software license of the supplied CD-ROM.

If you wish to ask any questions as to the software, please contact (sav.pj.gpl.pavc@ml.jp.panasonic.com) by email.

Pursuant to at the directive 2004/108/EC, article 9(2)

Panasonic Testing Centre

Panasonic Service Europe, a division of Panasonic Marketing Europe GmbH

Winsbergring 15, 22525 Hamburg, F.R. Germany

Precautions for use

Accessories

Make sure that the following accessories are provided with your projector. Numbers in the brackets () show the number of accessories.

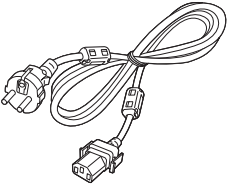
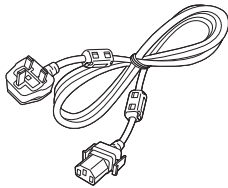
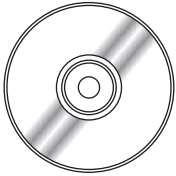
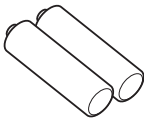
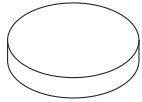
Wireless remote control unit (x1) (N2QAYB000696)	Power cord (x1) (TXFSX02RYJZ)	Power cord (x1) (TXFSX02RYLZ)
		
CD-ROM (x1) (TXFQB02VKQ4)	AA/R6 battery (x2)	Lens cover (x1) (TEEC5524)
	 (For remote control unit)	 (Attached to the projector at the time of purchase)

Attention

- After unpacking the projector, discard the power cord cap and packaging material properly.
- For lost accessories, consult your dealer.
- The part numbers of accessories and separately sold components are subject to change without notice.
- Store small parts in an appropriate manner, and keep them away from young children.
- Store the lens cover properly.
The lens cover protects the projection lens from dust and dirt.
Please put the supplied lens cover on the projector when you do not use it.

■ Contents of the supplied CD-ROM

The contents of the supplied CD-ROM are as follows.

Instruction/list (PDF)	Software
<ul style="list-style-type: none"> ● Operating Instructions – Functional Manual ● Multi Projector Monitoring & Control Software Operation Manual ● Logo Transfer Software Operation Manual ● List of Compatible Projector Models <ul style="list-style-type: none"> – This is a list of projectors that are compatible with the software contained in the CD-ROM and their restrictions. ● Software license (GNU GENERAL PUBLIC LICENSE, GNU LESSER GENERAL PUBLIC LICENSE) 	<ul style="list-style-type: none"> ● Multi Projector Monitoring & Control Software (Windows) <ul style="list-style-type: none"> – This software allows you to monitor and control multiple projectors connected to the LAN. ● Logo Transfer Software (Windows) <ul style="list-style-type: none"> – This software allows you to create original images, such as company logos to be displayed when projection starts, and transfer them to the projector.

Optional accessories

Optional accessories (product name)	Model No.
Ceiling mount bracket	ET-PKA110H (for high ceilings), ET-PKA110S (for low ceilings)
Replacement lamp unit	ET-LAA110

Start-up display

The initial setting screen is displayed when the projector is turned on for the first time after purchase or when executing [INITIALIZE ALL] (➔ page 72). Set them in accordance with circumstances. In other occasions, you can change the settings by menu operations.

Note

- When the projector is turned on for the first time, you may be required to adjust with the zoom ring and focus ring in the front of the projector body to make the menu screen clearer. Refer to “Adjusting the image” (➔ page 37) for details.

Initial setting (display language)

Select the language to show on the screen. (➔ page 59)

- Press ▲▼◀▶ to select the desired language.



- Press the <ENTER> button to proceed to the initial setting.

Initial setting (projector setup)

Select an item for each of [PROJECTION METHOD] and [HIGH ALTITUDE MODE].

- Press ▲▼ to select an item.
- Press ◀▶ to switch the setting.

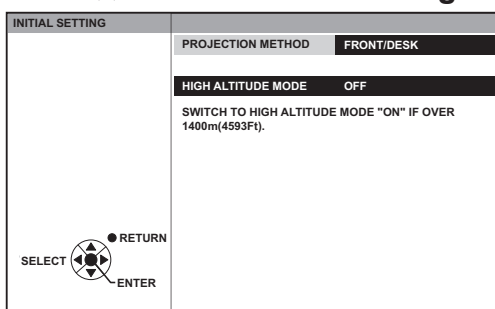

[PROJECTION METHOD] (➔ page 65)

[FRONT/DESK]	Setting on a desk, etc., in front of the screen
[FRONT/CEILING]	Mounting on a ceiling using the ceiling mount bracket (optional) in front of the screen
[REAR/DESK]	Setting on a desk, etc., behind the screen (using a translucent screen)
[REAR/CEILING]	Mounting on a ceiling using the ceiling mount bracket (optional) behind the screen (using a translucent screen)

[HIGH ALTITUDE MODE] (➔ page 65)

[OFF]	Using the projector at a place lower than 1 400 m (4 593 ft) above sea level
[ON]	Using the projector at a high altitude (1 400 m (4 593 ft) or higher and lower than 2 700 m (8 858 ft) above sea level)

- Press the <ENTER> button to complete the initial setting.

Note

- If you press the <RETURN> button in the initial setting (projector setup) screen, you can go back to the initial setting (display language) screen.

About your projector

Remote control

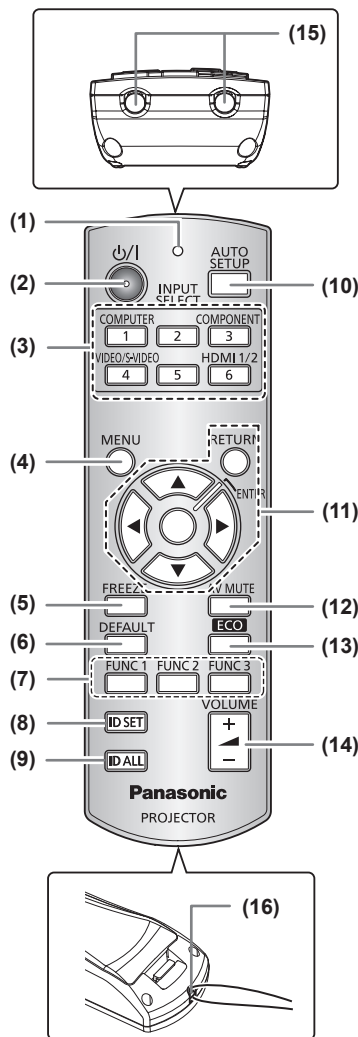

- (1) **Remote control indicator**
Flashes by pressing any buttons.
- (2) **Power <⏻/|> button**
Sets the projector to the standby mode when the <MAIN POWER> switch on the projector is set to <ON>. Starts projection when the projector power is off and in the standby mode.
- (3) **Input selection (<COMPUTER>, <COMPONENT>, <VIDEO/S-VIDEO>, and <HDMI 1/2>) buttons**
Switches the input signal to project. (➔ page 40)
Used to set the ID number of the remote control and a security password. (➔ page 22)
- (4) **<MENU> button**
Displays the main menu screen. (➔ page 42)
- (5) **<FREEZE> button**
Used to temporarily freeze the image and turn off sound. (➔ page 39)
- (6) **<DEFAULT> button**
Restores the contents of the sub-menu to the factory default setting. (➔ page 43)
- (7) **<FUNC1> to <FUNC3> buttons**
Assigns a frequently used operation and use as a shortcut button. (➔ page 41)
- (8) **<ID SET> button**
Sets the ID number of the remote control when the system uses multiple projectors. (➔ page 22)
- (9) **<ID ALL> button**
Simultaneously controls all the projectors with one remote control when the system uses multiple projectors. (➔ page 22)
- (10) **<AUTO SETUP> button**
Automatically adjusts [SHIFT], [DOT CLOCK], and [CLOCK PHASE] when computer signal is input.
- (11) **▲▼◀▶ buttons/<RETURN> button/<ENTER> button**
Used to operate the menu screen.
Also used to enter the password for [SECURITY] or to enter characters.
- (12) **<AV MUTE> button**
Used to temporarily turn off the image and sound. (➔ page 39)
- (13) **<ECO> button**
Displays the setting screen for the ECO management. (➔ page 41)
- (14) **<VOLUME +>/<VOLUME -> button**
Adjusts the volume of the audio output. (➔ page 41)
- (15) **Remote control signal transmitter**
- (16) **Strap hole**
Attach a strap onto the remote control for your convenience.

Attention

- Do not drop the remote control.
- Avoid contact with liquids or moisture.
- Do not attempt to modify or disassemble the remote control.
- When strap is attached to the remote control, do not fling the remote control while holding the strap.

Note

- The remote control can be used within a distance of about 15 m (49'2") if pointed directly at the remote control receiver. The remote control can control at angles of up to $\pm 15^\circ$ vertically and $\pm 30^\circ$ horizontally, but the effective control range may be reduced.
- If there are any obstacles between the remote control and the remote control signal receptor, the remote control may not operate properly.
- The signal will be reflected off the screen. However, the operating range may differ due to the screen material.
- If the remote control signal receptor receives strong light such as fluorescent light directly, the remote control may not operate properly. Use it in a place distant from the light source.

About your projector

Projector body

Front, top, and side view

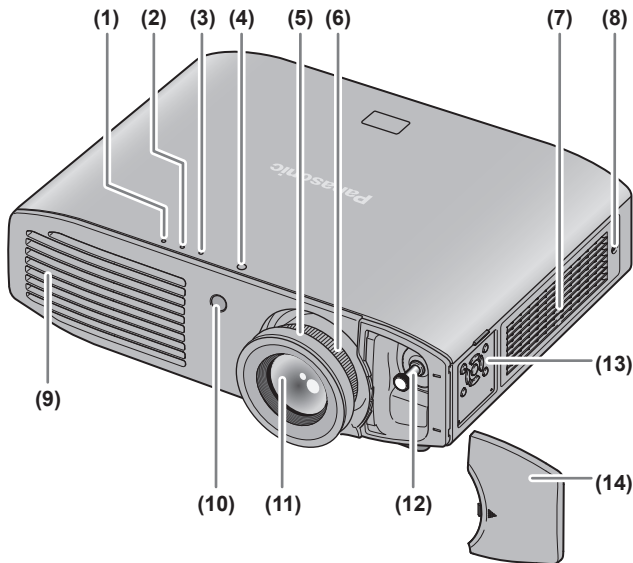

Rear and bottom view

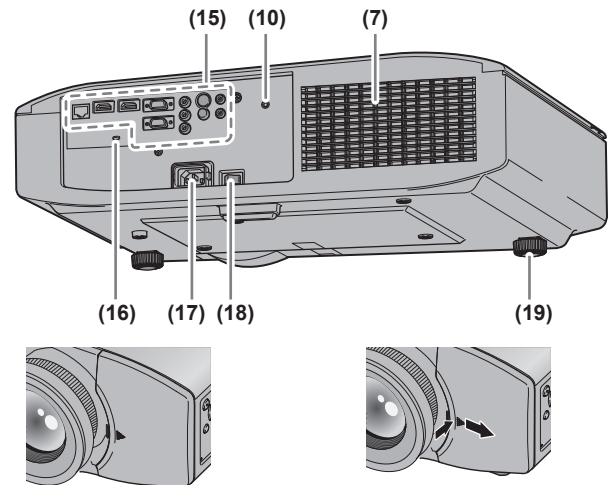

When the lens shift cover is attached

Removing the lens shift cover
Press the lens shift cover and slide it to remove.

Attention

- Keep your hands and other objects away from the air exhaust port.
 - Keep your hands and face away.
 - Do not insert your fingers.
 - Keep heat-sensitive articles away.

Heated air from the air exhaust port can cause burns, injury, or deformations.

- (1) **Power indicator <ON (G)/STANDBY (R)>**
Displays the status of the power.
- (2) **Lamp indicator <LAMP>**
Displays the status of the lamp.
- (3) **Temperature indicator <TEMP>**
Displays the status of the internal temperature or the air filter unit.
- (4) **Color sensor window**
Detects the brightness and color of the surroundings.
- (5) **Focus ring**
Adjusts focus.
- (6) **Zoom ring**
Adjusts zoom.
- (7) **Air intake port**
- (8) **Air filter cover**
There is an air filter unit inside. (➔ page 97)

(9) **Air exhaust port**

(10) **Remote control signal receiver**

(11) **Projection lens**

(12) **Lens shift lever**
Adjusts lens shift.

(13) **Control panel** (➔ page 21)

(14) **Lens shift cover**

(15) **Connecting terminals** (➔ page 21)

(16) **Security slot**
This security slot is compatible with the Kensington security cables.

(17) **<AC IN> terminal**
Connect the supplied power cord.

(18) **<MAIN POWER> switch**
Turns off/on the main power.

(19) **Adjustable feet**
Adjusts the projection angle.

Attention

- Do not block the ventilation ports (intake and exhaust) of the projector.

Control panel

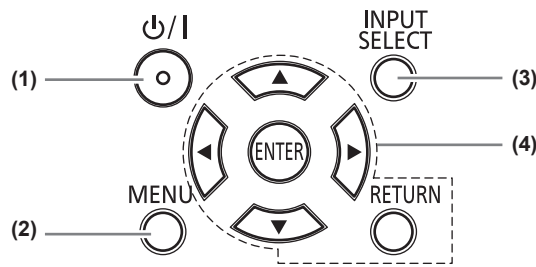

- (1) **Power <⏻/|> button**
Sets the projector to the standby mode when the <MAIN POWER> switch on the projector is set to <ON>. Starts projection when the projector power is off and in the standby mode.
- (2) **<MENU> button**
Displays the main menu.
- (3) **<INPUT SELECT> button**
Switches the input signal to project. (➡ page 40)
- (4) **<▲▼◀▶> buttons/<RETURN> button/<ENTER> button**
Used to operate the menu screen. Also used to enter the password for [SECURITY] or to enter characters.

Connecting terminals

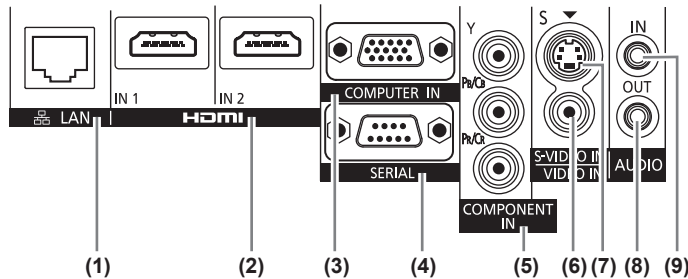

- (1) **<LAN> terminal**
This is a terminal to connect to the network.
- (2) **<HDMI IN 1>/<HDMI IN 2> terminals**
This is a terminal to input the HDMI signal.
- (3) **<COMPUTER IN> terminal**
This is a terminal to input the RGB signal or the YCbCr/YPbPr signal.
- (4) **<SERIAL> terminal**
This is a RS-232C compatible terminal to externally control the projector by connecting a computer.
- (5) **<COMPONENT IN> terminal**
This is a terminal to input the YCbCr signal or the YPbPr signal.
- (6) **<VIDEO IN> terminal**
This is a terminal to input the video signal.
- (7) **<S-VIDEO IN> terminal**
This is a terminal to input the S-video signal.
- (8) **<AUDIO OUT> terminal**
This is a terminal to output the audio signal input to the projector.
- (9) **<AUDIO IN> terminal**
This is a terminal to input the audio signal.

Attention

- When a LAN cable is directly connected to the projector, the network connection must be made indoors.

Using Remote control

Inserting and removing the batteries

1) Open the cover.

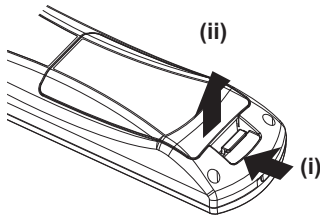

2) Insert the batteries and close the cover (insert the **+** side first).

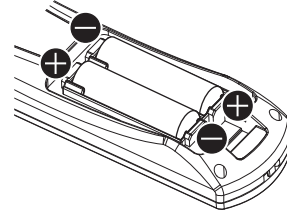

- When removing the batteries, perform the steps in the reverse order.

Setting Remote control ID numbers

When you use the system with multiple projectors, you can operate all the projectors simultaneously or each projector individually using single remote control, if a unique ID number is assigned to each projector.

After setting the ID number of the projector, set same ID number on the remote control.

The ID number of the projector is set to [ALL] by the factory default. When using a single projector, press the <ID ALL> button on the remote control. If you are not sure of the ID number of the projector, you can control the projector by pressing the <ID ALL> button.

■ How to set

1) Press the <ID SET> button on the remote control.

2) Within five seconds, press the one-digit ID number set on the projector using the number (<1> - <6>) buttons.

- If you press the <ID ALL> button, you can operate the projectors regardless the setting of the projectors' ID numbers.

Attention

- Since setting of the ID number on the remote control can be performed even without the projector, do not press the <ID SET> button carelessly. If you press the <ID SET> button and do not press the number (<1> - <6>) buttons within five seconds, the ID will remain the same as before the <ID SET> button was pressed.
- The ID number set on the remote control will be stored unless it is set again. However, it will be erased if the remote control is left with dead batteries. Set the same ID number again when the batteries are replaced.

Note

- Set the ID number of the projector from the [PROJECTOR SETUP] menu → [PROJECTOR ID] (➔ page 64).

Setting up

Projection method

You can use the projector with any of the following four projection methods. Select the appropriate method depending on the environment.

■ Setting on a desk/floor and projecting forward

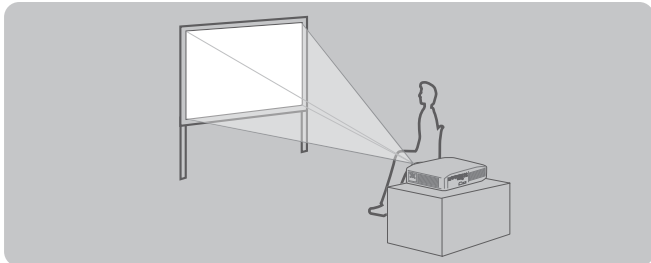

Menu item*1	Method
[PROJECTION METHOD]	[FRONT/DESK]

■ Mounting on the ceiling and projecting forward

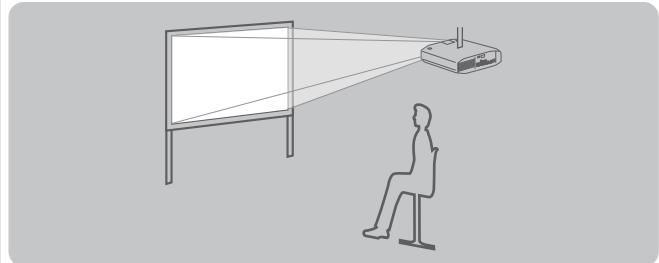

Menu item*1	Method
[PROJECTION METHOD]	[FRONT/CEILING]

■ Mounting on the ceiling and projecting from rear

(Using the translucent screen)

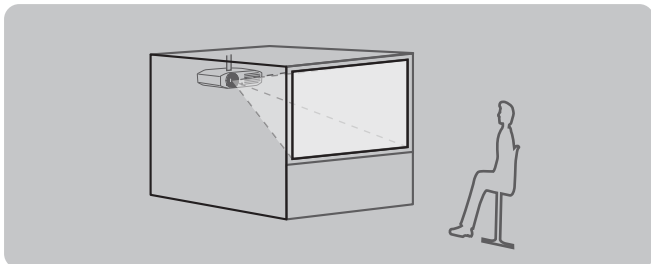

Menu item*1	Method
[PROJECTION METHOD]	[REAR/CEILING]

■ Setting on a desk/floor and projecting from rear

(Using the translucent screen)

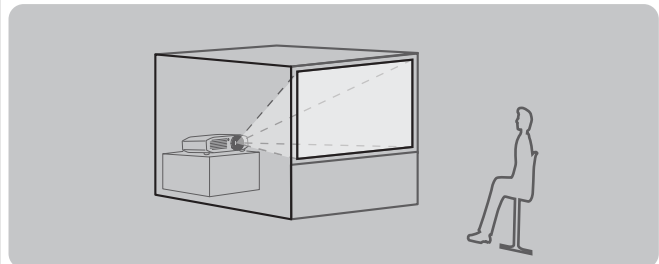

Menu item*1	Method
[PROJECTION METHOD]	[REAR/DESK]

*1: For details of the menu items, confirm from the [PROJECTOR SETUP] menu → [PROJECTION METHOD] (▶ page 65).

Parts for ceiling mount (optional)

You can install the projector on the ceiling using the optional ceiling mount bracket (ET-PKA110H: for high ceilings, ET-PKA110S: for low ceilings).

- Use only the ceiling mount brackets specified for this projector.
- Refer to the installation manual for the ceiling mount bracket when you install the bracket and the projector.

Attention

- To ensure the projector performance and security, installation of the ceiling mount bracket must be carried out by your dealer or a qualified technician.

Setting up

Screen size and throw distance

Install the projector referring to the following figures and tables describing projection distances. Image size and image position can be adjusted in accordance with the screen size and screen position.

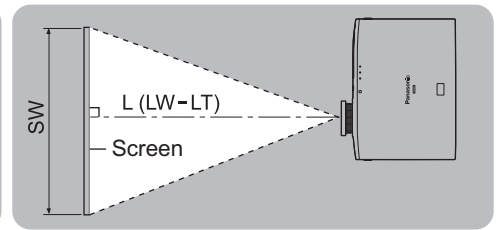
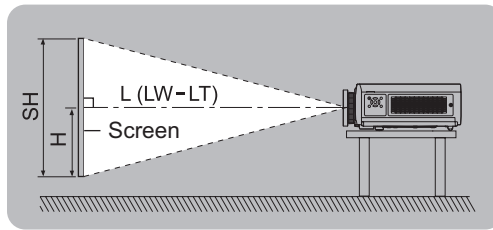
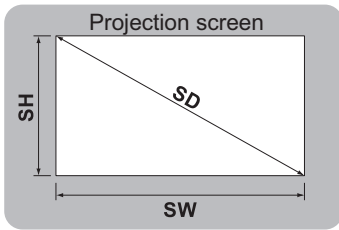

L (LW/LT)*1	Projection distance (m)
SH	Image height (m)
SW	Image width (m)
H	Distance from the center of lens to the image lower end (m)
SD	Image diagonal size (m)

*1: LW: Minimum projection distance
LT: Maximum projection distance

■ Projection distance

● When the screen aspect ratio is 16:9

(All measurements below are approximate and may differ slightly from the actual measurements.)

(unit: m)

Image diagonal size (SD)	Projection distance (L)		Distance from the center of lens to the image lower end (H)
	Minimum projection distance (LW)	Maximum projection distance (LT)	
1.02 (40")	1.11 (3' 8")	2.29 (7' 6")	-0.08 - 0.58
1.27 (50")	1.41 (4' 8")	2.87 (9' 5")	-0.09 - 0.71
1.52 (60")	1.70 (5' 7")	3.46 (11' 4")	-0.11 - 0.86
1.78 (70")	1.99 (6' 6")	4.04 (13' 3")	-0.13 - 1.00
2.03 (80")	2.28 (7' 6")	4.62 (15' 2")	-0.15 - 1.15
2.29 (90")	2.57 (8' 5")	5.21 (17' 1")	-0.17 - 1.29
2.54 (100")	2.87 (9' 5")	5.79 (19' 0")	-0.19 - 1.44
3.05 (120")	3.45 (11' 4")	6.96 (22' 10")	-0.22 - 1.71
3.81 (150")	4.33 (14' 2")	8.70 (28' 7")	-0.28 - 2.15
5.08 (200")	5.79 (19' 0")	11.62 (38' 1")	-0.37 - 2.86
6.35 (250")	7.25 (23' 9")	14.53 (47' 8")	-0.47 - 3.58
7.62 (300")	8.71 (28' 7")	17.45 (57' 3")	-0.56 - 4.30

● When the screen aspect ratio is 4:3

(All measurements below are approximate and may differ slightly from the actual measurements.)

(unit: m)

Image diagonal size (SD)	Projection distance (L)		Distance from the center of lens to the image lower end (H)
	Minimum projection distance (LW)	Maximum projection distance (LT)	
1.02 (40")	1.38 (4' 6")	2.82 (9' 3")	-0.02 - 0.63
1.27 (50")	1.74 (5' 9")	3.53 (11' 7")	-0.02 - 0.78
1.52 (60")	2.10 (6' 11")	4.25 (13' 11")	-0.03 - 0.94
1.78 (70")	2.45 (8' 0")	4.96 (16' 3")	-0.03 - 1.10
2.03 (80")	2.81 (9' 3")	5.67 (18' 7")	-0.04 - 1.26
2.29 (90")	3.17 (10' 5")	6.39 (21' 0")	-0.04 - 1.41
2.54 (100")	3.53 (11' 7")	7.10 (23' 4")	-0.05 - 1.57
3.05 (120")	4.24 (13' 11")	8.53 (28' 0")	-0.05 - 1.88
3.81 (150")	5.32 (17' 5")	10.67 (35' 0")	-0.07 - 2.36
5.08 (200")	7.11 (23' 4")	14.24 (46' 9")	-0.09 - 3.14
6.35 (250")	8.90 (29' 2")	17.81 (58' 5")	-0.12 - 3.93
7.62 (300")	10.69 (35' 1")	21.38 (70' 2")	-0.15 - 4.72

■ Projection distance calculation formula

You can calculate projection dimensions from the projection screen size SD (m) using the formula below. The unit of the formula is "m". (All values obtained using the formula below are approximate and may differ slightly from the actual values.)

	Screen aspect ratio 16:9	Screen aspect ratio 4:3
Projection screen height (SH)	= SD (m) x 0.490	= SD (m) x 0.6
Projection screen width (SW)	= SD (m) x 0.872	= SD (m) x 0.8
Minimum projection distance (LW)	= SD (m) x 1.1503 - 0.056	= SD (m) x 1.4098 - 0.053
Maximum projection distance (LT)	= SD (m) x 2.2951 - 0.041	= SD (m) x 2.8106 - 0.037

Setting up

Adjusting adjustable feet

In order to make the projection screen rectangle, place the projector on a flat surface with its front surface parallel to the screen. If the screen is tilted lower, extend the adjustable feet and adjust the angle to make a rectangle screen. If the projector is tilted horizontally, also use the adjustable feet and adjust the angle to keep the projector flat. The adjustable feet can be extended by turning it as shown in the figure, and it is retracted by turning it in the reverse direction.

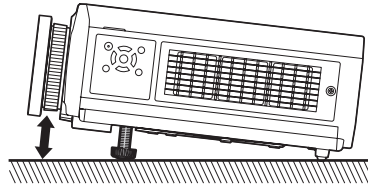
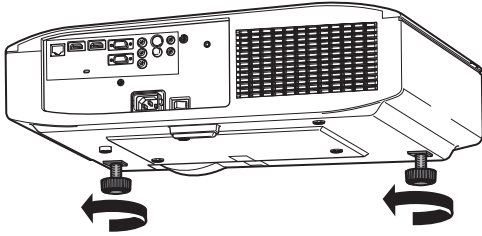

Adjustable range

Adjustable feet: 16 mm (5/8")

Attention

- Heated air is expelled from the air exhaust port. Do not touch the air exhaust port directly when adjusting the adjustable feet. (➔ page 20)

Note

- Tighten the adjustable feet until you hear them click into place.

Lens shift and positioning

If the projector is not positioned right in front of the center of the screen, you can adjust the projected image position using the lens shift function.

■ Adjusting the lens shift

1) Remove the lens shift cover.

- Refer to "Removing the lens shift cover" (➔ page 20) for how to remove the lens shift cover.

2) Rotate the lens shift lever counterclockwise to release the lock.

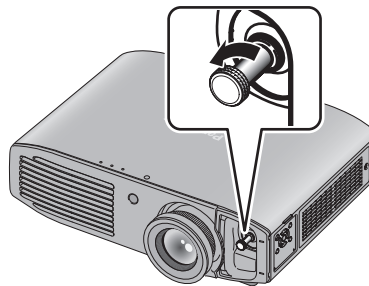

3) Adjust projection using the lens shift lever.

- When adjusting the horizontal position, move the lens shift lever horizontally.

Up to approx. 26% of the projection screen Up to approx. 26% of the projection screen

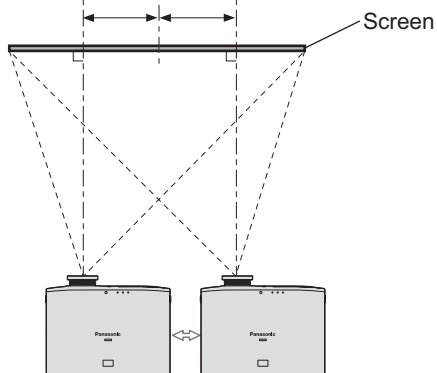

Move the lens shift lever in direction A

Move the lens shift lever in direction B

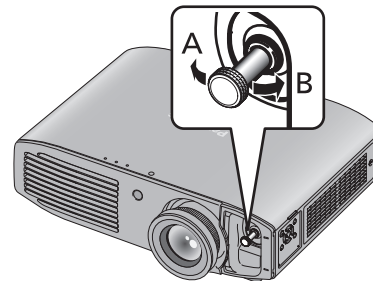

- When adjusting the vertical position, move the lens shift lever vertically.

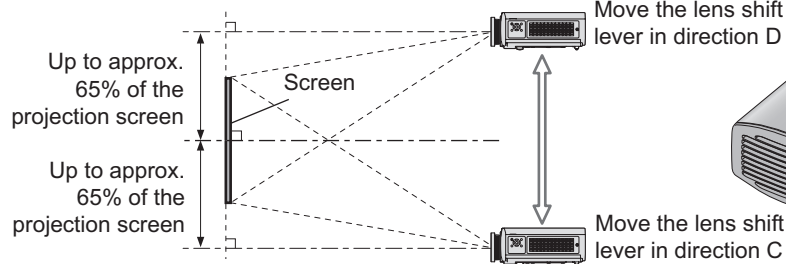

Move the lens shift lever in direction D

Move the lens shift lever in direction C

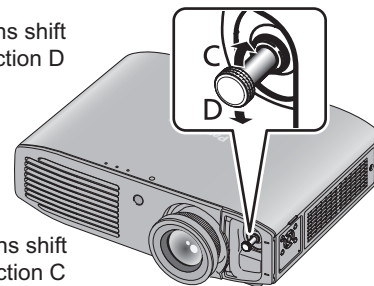

Attention

- Do not force the lens shift lever. If excessive force is placed on the lever, it may break.

4) Rotate the lens shift lever clockwise to fix.

5) Attach the lens shift cover.

Setting up

■ Projector location range

The setting position can be adjusted within the following range.

Refer to "Screen size and throw distance" (➔ page 24) for the projection screen height (SH) and width (SW).

● Projector setting range when the screen position is fixed

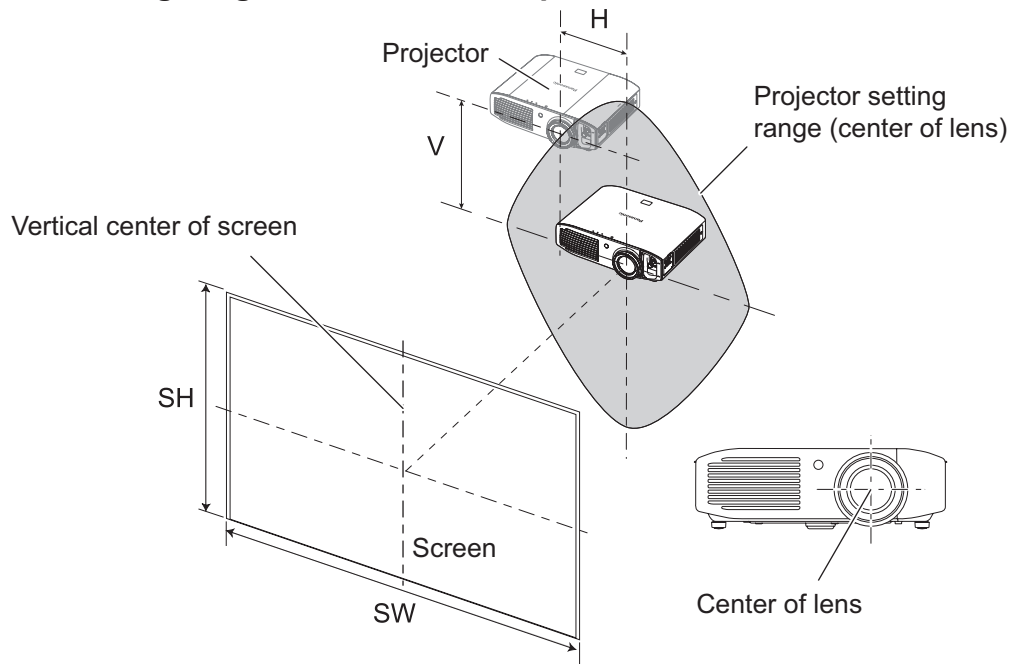

● Shift range of the projection screen when the projector position is fixed

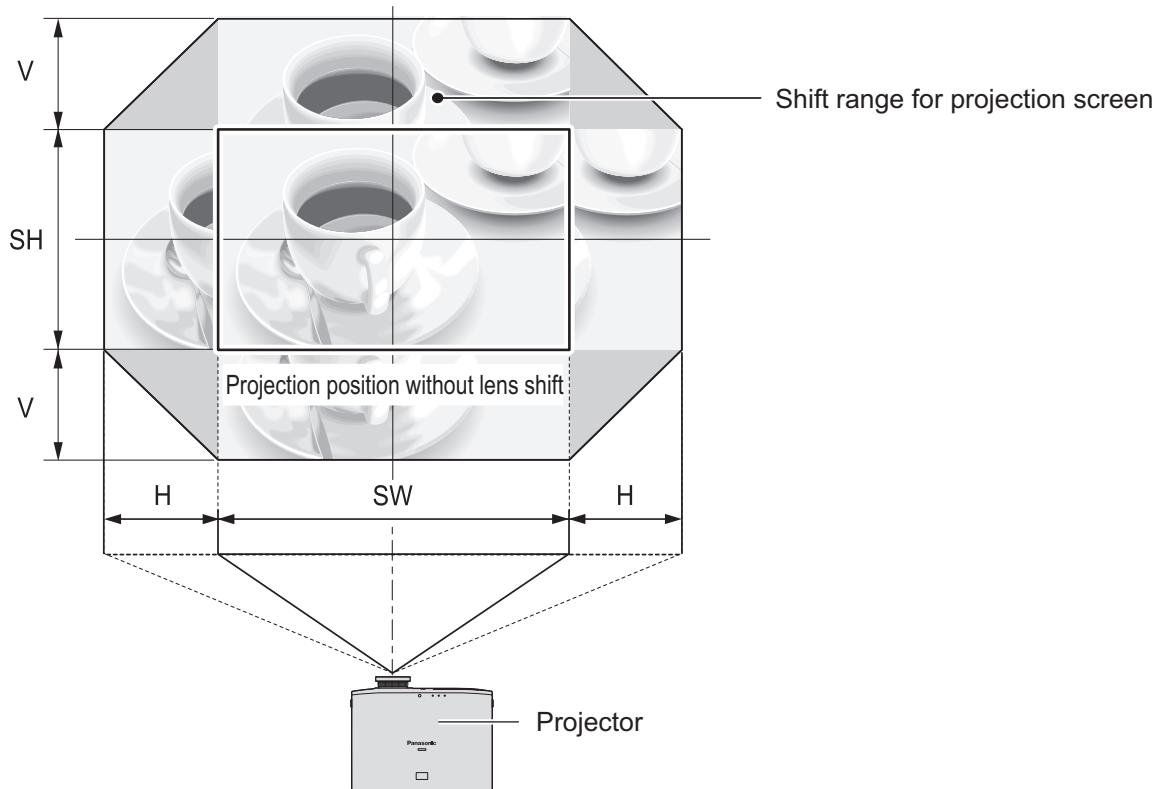

Shift direction	Maximum range of adjustment
Horizontal (H)	Approximately 26% of the projection screen width (SW)
Vertical (V)	Approximately 65% of the projection screen height (SH)

Note

- Position the projector directly in front of the screen and move the lens shift lever to the center to obtain the optimum projection image quality.
- When the lens shift lever is at the horizontal limit of the shift range, you cannot move the lever to the vertical limit. Likewise, when the lens shift lever is at the vertical limit of the shift range, you cannot move the lever to the horizontal limit.
- The focus may change when the lens position is shifted out of the adjustment range. This is because the movement of the lens is restricted to protect the optical parts.
- If the projected image cannot be fit into the screen using the lens shift function alone, adjust the projection angle using the adjustable feet (➡ page 26), and then correct the keystone distortion using the [POSITION] menu → [KEystone] (➡ page 54).

Connections

Before connecting to the projector

- Read carefully the instruction manual for the device to be connected.
- Turn off the power switch of the devices before connecting cables.
- If any connection cable is not supplied with the device, or if no optional cable is available for the connection of the device, prepare a necessary system connection cable.
- Video signals containing too much jitter may cause the images on the screen to randomly wobble or wafture. In this case, a time base corrector (TBC) must be connected.
- The projector accepts video signals, S-video signals, analog RGB signals (with TTL sync. Level), and digital signals.
- Some computer models are not compatible with the projector.
- Refer to “List of compatible signals” (➔ page 114) for the types of video signals that can be used with the projector.

■ <S-VIDEO IN> terminal pin assignments and signal names

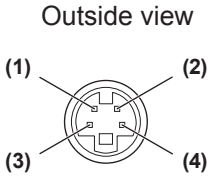
Outside view	Pin No.	Signal name
	(1)	GND (luminance signal)
	(2)	GND (color signal)
	(3)	Luminance signal
	(4)	Color signal

■ <COMPUTER IN> terminal pin assignments and signal names

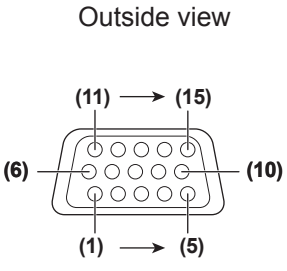
Outside view	Pin No.	Signal name
	(1)	R/P _R
	(2)	G/G, SYNC/Y
	(3)	B/P _B
	(12)	DDC data
	(13)	HD/SYNC
	(14)	VD
	(15)	DDC clock
	(4)	
	(8)	
	(9)	

(4) and (9) are not used.
 (5) - (8), (10), and (11) are GND terminals.

<HDMI IN 1>/<HDMI IN 2> terminals pin assignments and signal names

Outside view	Pin No.	Signal name	Pin No.	Signal name
Even-numbered pins (2) to (18)	(1)	T.M.D.S data 2+	(11)	T.M.D.S clock shield
	(2)	T.M.D.S data 2 shield	(12)	T.M.D.S clock-
	(3)	T.M.D.S data 2-	(13)	CEC
	(4)	T.M.D.S data 1+	(14)	—
	(5)	T.M.D.S data 1 shield	(15)	SCL
	(6)	T.M.D.S data 1-	(16)	SDA
Odd-numbered pins (1) to (19)	(7)	T.M.D.S data 0+	(17)	DDC/CEC GND
	(8)	T.M.D.S data 0 shield	(18)	+5 V
	(9)	T.M.D.S data 0-	(19)	Hot plug detection
	(10)	T.M.D.S clock+		

Connecting example: Input terminals

<S-VIDEO IN>/<VIDEO IN>/<COMPONENT IN> terminals

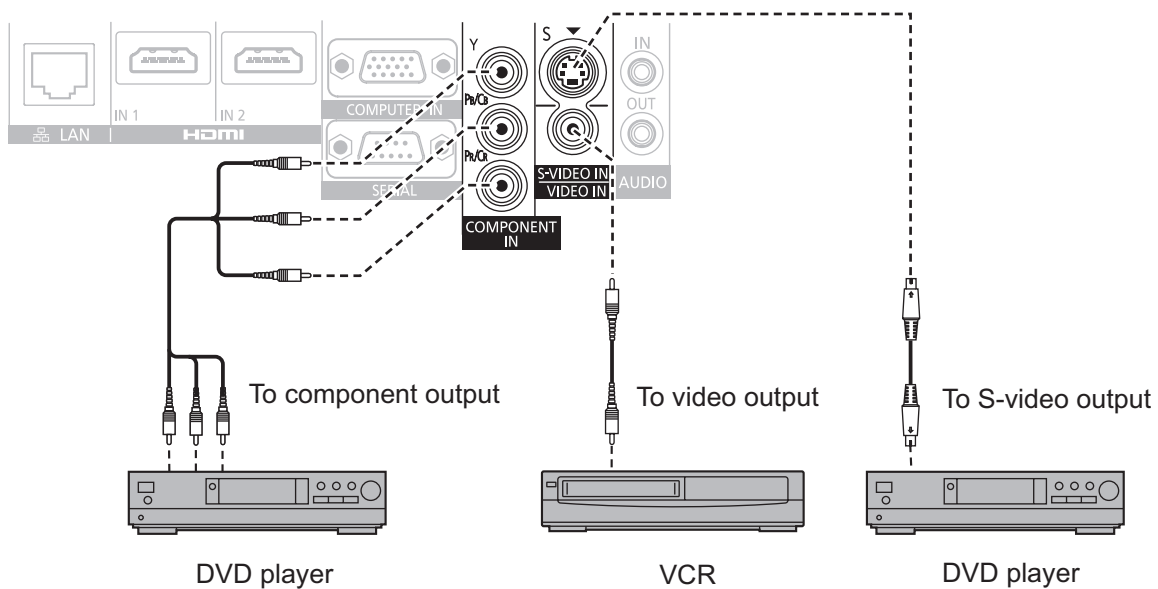

Connections

■ <LAN>/<HDMI IN 1>/<HDMI IN 2>/<COMPUTER IN>/<SERIAL>/<AUDIO IN>/<AUDIO OUT> terminals

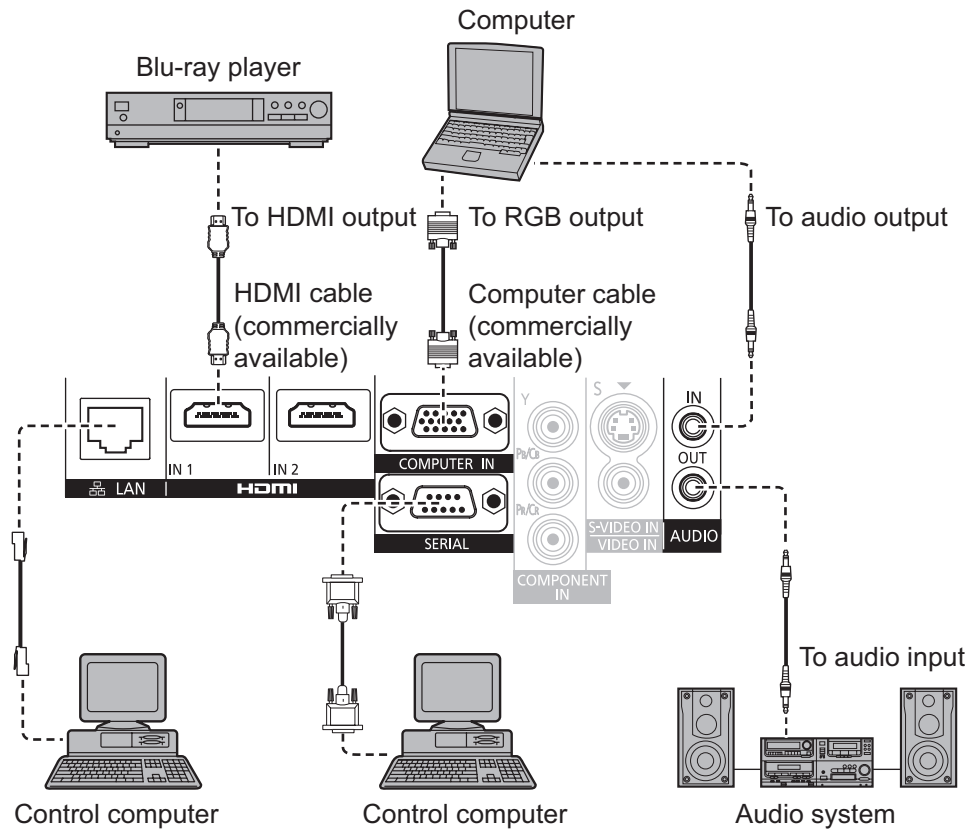

Note

- Use an HDMI High Speed cable that conforms to HDMI standards. If a cable that does not meet HDMI standards is used, video may be interrupted or may not be displayed.
- It is possible to connect with DVI devices via an HDMI/DVI conversion adapter, but some devices may not project the image properly or other such problems could be encountered.
- If [AUDIO IN SELECT] is set wrongly, the projector may not operate properly in audio output or other functions. (➡ page 70)
- This projector is not compatible with VIERA Link (HDMI).
- When connecting to the <SERIAL> terminal, refer to “<SERIAL> terminal” (➡ page 111).
- If you operate the projector using the computer with the resume feature (last memory), you may have to reset the resume feature to operate the projector.

Caution

When connecting the projector to a computer or an external device, use the power cord supplied with each device and commercially available shielded cables.

Switching on/off

Connecting the power cord

Use the supplied power cord to prevent removal of the power cord and make sure that it is fully inserted into the projector.

Confirm that the <MAIN POWER> switch is on the <OFF> side before connecting the power cord.
For detailed power cord handling, refer to "Read this first!" (➡ pages 2 to 8).

■ Attaching

- 1) Check the shapes of the <AC IN> terminal on the back side of the projector and the power cord connector and fully insert until the tabs on the left and right make a click sound.

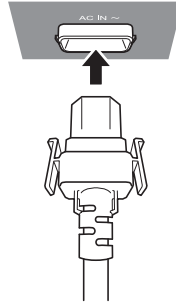

- 2) Connect the power plug to an outlet.

■ Removing

- 1) Confirm that the <MAIN POWER> switch is on the <OFF> side and unplug the power cord from the outlet.
- 2) Remove the plug from the <AC IN> terminal while pushing on the tabs on the sides.

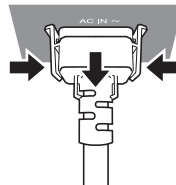

Switching on/off

Power indicator

The power indicator indicates the power status. Check the status of the power indicator <ON (G)/STANDBY (R)> before operating the projector.

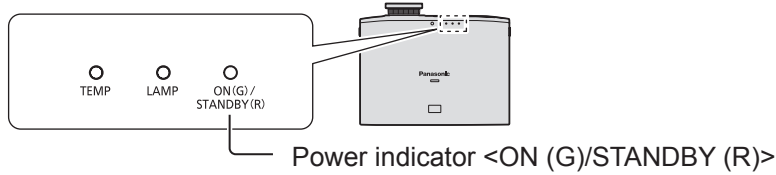

Indicator status		Status
No illumination or flashing		The main power is switched off.
Red	Lit	When [STANDBY MODE] is set to [ECO], the power is switched off. (The projector is in the standby mode.) Press the power <⏻/⏪> button to start projection. ● Does not operate when the lamp indicator <LAMP> or temperature indicator <TEMP> is flashing. (➡ page 95)
	Flashing	When [STANDBY MODE] is set to [NORMAL], the power is switched off. (The projector is in the standby mode.) Press the power <⏻/⏪> button to start projection. ● Does not operate when the lamp indicator <LAMP> or temperature indicator <TEMP> is flashing. (➡ page 95)
Green	Flashing	The projector is preparing to project. Projection starts after a while.
	Lit	Projecting.
Orange	Lit	The projector is preparing to switch off the power. The power is switched off after a while. (Changes to the standby mode.)
	Flashing	The power <⏻/⏪> button is pressed in the power off operation. The projector is preparing to project. Projection starts after a while.

Note

- The power <⏻/⏪> button is pressed in the power off operation, it may take some time to enter projection mode.
- The projector consumes electrical power even when the power is off (when the power indicator <ON (G)/STANDBY (R)> illuminates or flashes red). Refer to "Power consumption" (➡ page 116) for the power consumption.

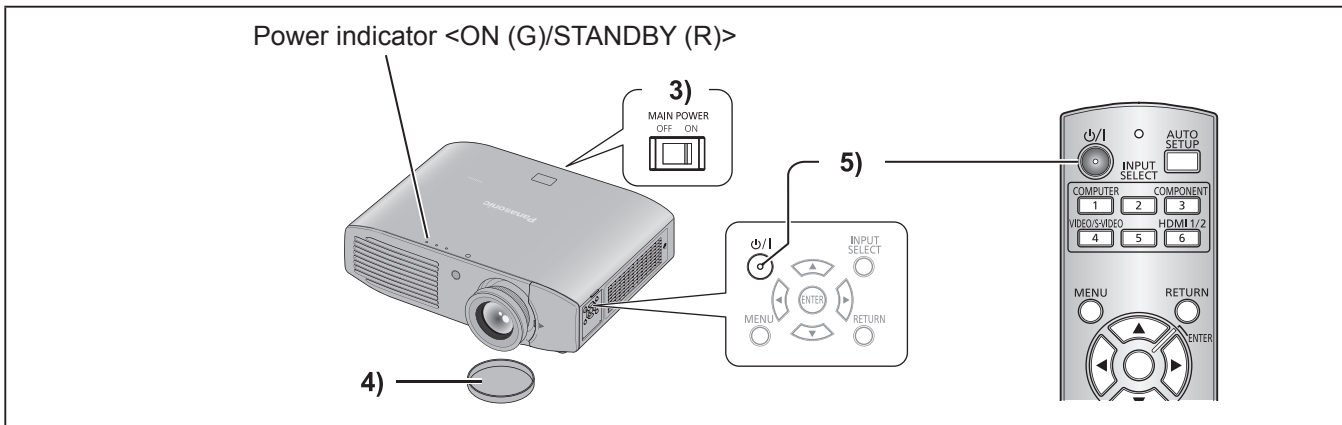

Switching on the projector

Check external device connections before switching on the projector.

- 1) **Connect the power cord to the projector.**
- 2) **Connect the power plug to an outlet.**
- 3) **Press the <ON> side of the <MAIN POWER> switch to turn on the power.**
 - The power indicator <ON (G)/STANDBY (R)> illuminates or flashes red.
- 4) **Remove the lens cover.**
 - Be sure to remove the lens cover before starting projection.
- 5) **Press the power <⏻/⏻> button.**
 - The power indicator <ON (G)/STANDBY (R)> flashes green, and after a while, changes to illuminate, and then projection starts.

Attention

- Using the projector while the lens cover is attached causes the device to heat up and can result in a fire.

Note

- Confirm that [CONTROL PANEL] (when operating on the control panel) or [REMOTE CONTROLLER] (when operating with the remote control) is set to [ENABLE] from the [SECURITY] menu → [CONTROL DEVICE SETUP] (➡ page 75). When you set the [SECURITY] menu, entering a password is required. (➡ page 73)
- When switching on the projector, a small rattling sound may be heard or when the luminous lamp is lit, a tinkling sound may be heard, but this is not a malfunction.
- During video projection, the cooling fan operates and makes a sound. This fan sound may change with ambient temperature and becomes louder when the lamp is turned on.

- Setting the [PROJECTOR SETUP] menu → [LAMP POWER] (➡ page 66) to [ECO] reduces operation sounds.
- When the lamp is turned off and immediately turned back on again, the video may temporarily flicker slightly at the start of projection due to lamp characteristics, but this is not a malfunction.
- When [ECO] is selected in [STANDBY MODE] under the [PROJECTOR SETUP] menu → [ECO MANAGEMENT] (➡ page 67), the initial image may appear about ten seconds later than when set to [NORMAL].
- If the direct power off function was used to set the <MAIN POWER> switch to <OFF> during projection, the next time the <MAIN POWER> switch is set to <ON> with the power plug connected to an outlet, the power indicator <ON (G)/STANDBY (R)> will soon illuminate green and an image will be projected. (When the [PROJECTOR SETUP] menu → [INITIAL START UP] (➡ page 65) is set to [LAST MEMORY] or [ON].)

Switching on/off

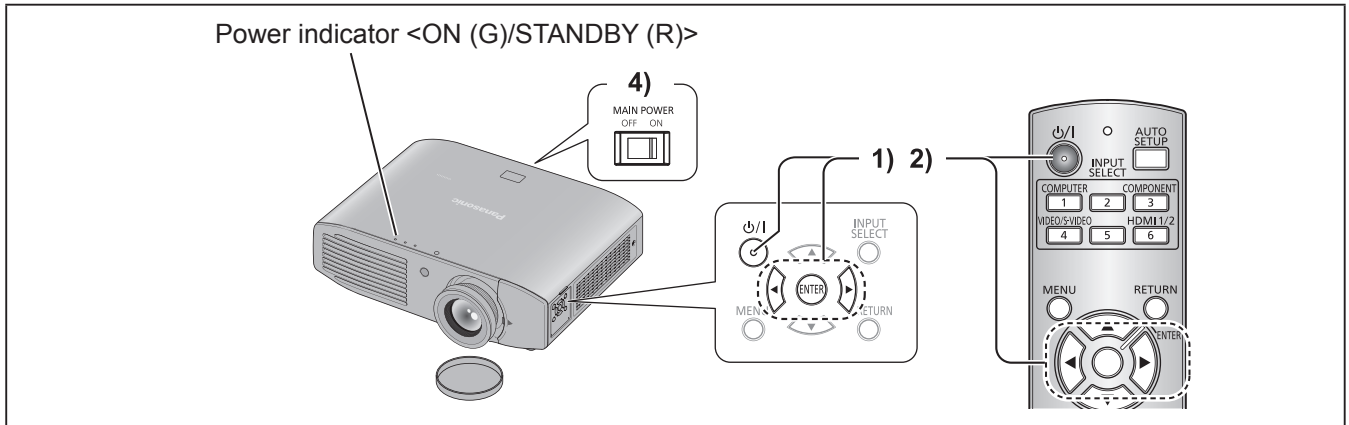

Switching off the projector

- 1) Press the power <⏻/|> button.**
 - The power off confirmation message is displayed.
- 2) Press <◀▶> to select [OK], and press the <ENTER> button. (Or press the power <⏻/|> button again.)**
 - Projection of the image will stop, and the power indicator <ON (G)/STANDBY (R)> on the projector illuminates orange. (The fan continues to operate.)
- 3) Wait until the power indicator <ON (G)/STANDBY (R)> of the projector turns red (until the fan stops).**
- 4) Press the <OFF> side of the <MAIN POWER> switch to turn off the power.**

Note

- Select [CANCEL] or press the <MENU> or <RETURN> button to close the power off confirmation message.
- The power can also be switched off when the power <⏻/|> button is pressed for at least 0.5 seconds.
- **Do not turn on the power immediately after turning it off.**

In the cooling state of the luminous lamp after the power is turned off, the lamp may not illuminate even if the power is turned on. After the power indicator illuminates or flashes red, turn off the main power and then back on again. Turning on the power while the lamp is still hot may shorten the lamp life.
- **Even when the power <⏻/|> button is pressed and the power is turned off, the projector consumes power if the main power is on.** Refer to "Power consumption" (➔ page 116) for the power consumption.

Direct power off function

Even if you turn the <MAIN POWER> switch <OFF> during projection or just after the luminous lamp turns off, the fan will rotate using internally stored power to cool the luminous lamp. In cases where the <MAIN POWER> switch is not easily turned <OFF>, such as during ceiling mount, you can safely turn off the power by using the power breaker switch. This function also works if a power outage occurs or if the power cable is accidentally disconnected from the outlet right after turning off the power.

Note

- If projection was stopped by turning off the power breaker switch and you turn on the power breaker again, the power indicator <ON (G)/STANDBY (R)> illuminates green and projection starts again. (When the [PROJECTOR SETUP] menu → [INITIAL START UP] (➔ page 65) is set to [LAST MEMORY] or [ON].)
- When the lamp has been cooled by the direct power off function, it may take longer than usual for the projector to start projection again.
- Confirm that the fan has stopped before packing the projector to transport or store.

Projecting

Check the connections of the external devices (➔ page 30), the connection of the power cord (➔ page 33), and turn on the power (➔ page 35) to start projection. Select the video for projection, and adjust appearance of the projected image.

Selecting the input signal

Select an input signal.

1) Switch on the external devices.

- Press the play button on an external device, such as a Blu-ray player. When the [DISPLAY OPTION] menu → [SIGNAL SEARCH] (➔ page 62) is set to [ON], the projector automatically searches for an input signal and starts projection.

2) Press the input selection (<COMPUTER>, <COMPONENT>, <VIDEO/S-VIDEO>, and <HDMI 1/2>) buttons on the remote control or press the <INPUT SELECT> button on the control panel.

- Image for a signal input to the selected terminal is projected.

Attention

- Images may not be projected properly depending on the external device or Blu-ray disc, DVD, etc. to be played back. Set [TV-SYSTEM] (➔ page 53), [RGB/YC_BC_R]/[RGB/YP_BP_R] (➔ page 53) from [PICTURE].
- Confirm the aspect ratio of the projection screen and the image, and switch to an optimum aspect ratio from the [POSITION] menu → [ASPECT] (➔ page 56).

Adjusting the image

1) Adjust the angle of the projector.

- Place the projector parallel to the screen, and then install it on a flat surface so that the screen becomes rectangle.
- If the screen is tilted lower than the screen, extend the adjustable feet to make a rectangle screen.
- Refer to “Adjusting adjustable feet” (➔ page 26) for details.

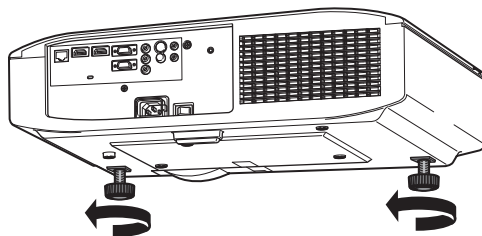

2) Remove the lens shift cover.

- Refer to “Removing the lens shift cover” (➔ page 20) for details.

Projecting

3) Rotate the lens shift lever counterclockwise to release the lock.

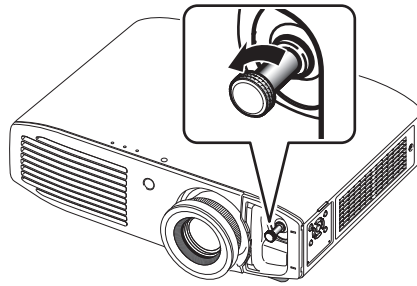

4) Adjusts lens shift.

- Adjust the projection position with the lens shift lever.
- Refer to “Lens shift and positioning” (➔ page 26) for details.

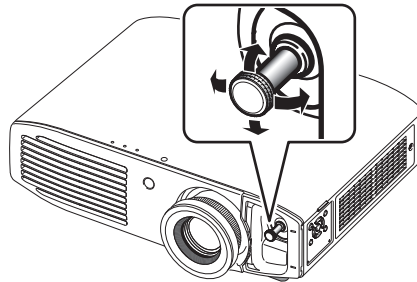

5) Rotate the lens shift lever clockwise to fix.

6) Attach the lens shift cover.

7) Adjust the zoom and focus.

- Turn zoom ring and focus ring to adjust.

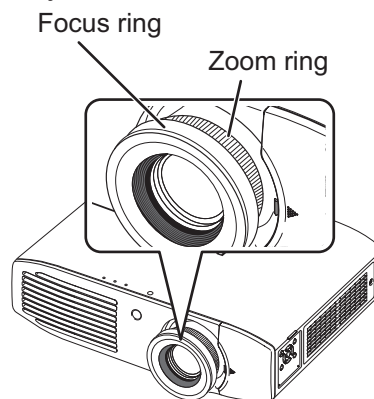

Note

- It is recommended that the images are projected continuously for at least 30 minutes before the focus is adjusted.
- As the projection screen size changes if the focus ring is turned, turn the zoom ring to fine-tune the projection screen size again.

Remote control operation

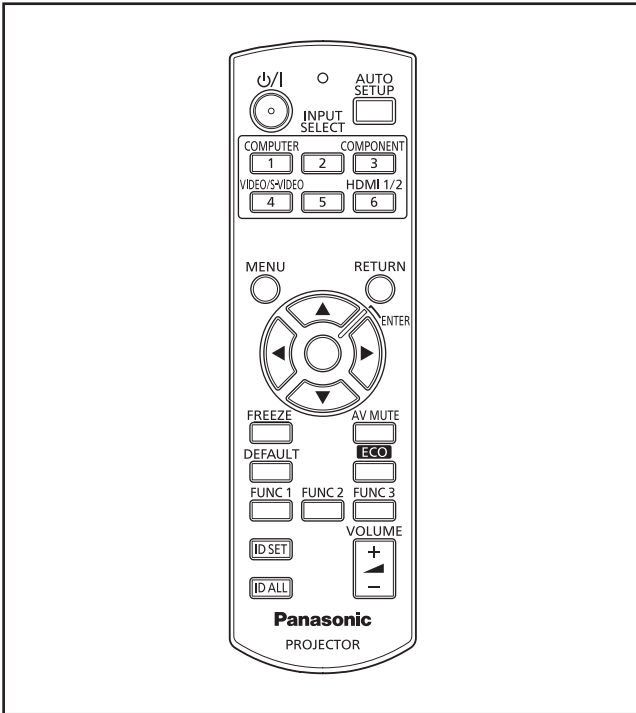

Using the Freeze function

You can freeze the projected image and stop the sound temporarily, regardless of the playing condition of the external device.

FREEZE
 button

- 1) **Press the <FREEZE> button on the remote control.**
 - The image disappears and the sound is muted.
- 2) **Press the <FREEZE> button again.**
 - The image and sound resume.

Note

- [FREEZE] is displayed on the screen while the freeze function is enabled.

Using the AV mute function

If the projector is not used for a certain period of time during the meeting intermission, for example, this function enables you to mute the sound and hide images temporarily.

AV MUTE
 button

- 1) **Press the <AV MUTE> button on the remote control.**
 - The image disappears and the sound is muted.
- 2) **Press the <AV MUTE> button again.**
 - The image and sound resume.

Note

- The projector is not equipped with an internal speaker. The audio is output from the external audio system connected to the <AUDIO OUT> terminal.

Remote control operation

Switching the input

The input for projection can be switched.

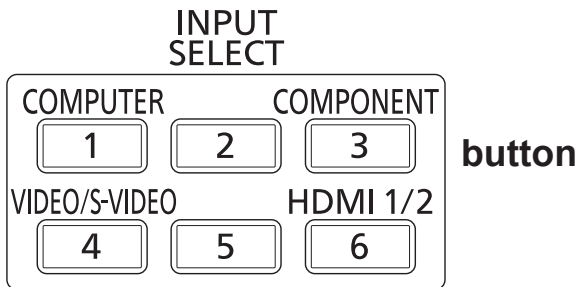

Press the input selection (<COMPUTER>, <COMPONENT>, <VIDEO/S-VIDEO>, and <HDMI 1/2>) buttons on the remote control.

<COMPUTER>	Switches to computer signal input mode.
<COMPONENT>	Switches to component (Y _C B _C R/ Y _P B _P R) signal input mode.
<VIDEO/ S-VIDEO>	Switches to S-video/video signal input mode. If either of the input modes has already been selected, switches to another input mode.
<HDMI 1/2>	Switches to HDMI signal input mode. If either of the input modes has already been selected, switches to another input mode.

Note

- Each time you press the <INPUT SELECT> button, the settings change as follows. (➡ page 21)

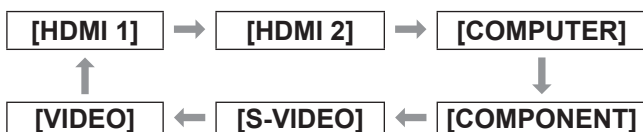

Using the Automatic setup function

During signal input from a computer, [SHIFT], [DOT CLOCK], and [CLOCK PHASE] can be adjusted automatically.



Press the <AUTO SETUP> button on the remote control.

Note

- During HDMI signal input, only [SHIFT] is adjusted automatically.
- The input search is activated when there is no signal. (When [SIGNAL SEARCH] (➡ page 62) is set to [ON])
- When signals exceeding the dot clock 162 MHz are input, [DOT CLOCK] (➡ page 55) and [CLOCK PHASE] (➡ page 55) cannot be set automatically.
- When you activate the auto setup function on images with blurred edges or dark images, operation may automatically stop. In this case, switch to a different image and press the <AUTO SETUP> button again.
- [AUTO SETUP] is displayed on the screen while the image is adjusted automatically.

Using the Function button

The <FUNC1> to <FUNC3> buttons on the remote control can be assigned to any frequent operations to be used as shortcut buttons.



Press the <FUNC1> to <FUNC3> button on the remote control.

■ To assign functions to the <FUNC1> to <FUNC3> buttons

- 1) Press the <MENU> button on the remote control or the projector to select a menu option (main menu, sub-menu, or advanced menu).
 - Refer to “Navigating through the menu” (➔ page 42) for on-screen menu operations.
- 2) Hold down any of the <FUNC1> to <FUNC3> buttons on the remote control for at least three seconds.

Note

- When the setting is complete, the assigned menu item appears on the right of the remote control operation guidance area on the lower part of the menu screen.

Using the ECO management function

Displays the setting screen for the ECO management.



Press the <ECO> button on the remote control.

Note

- For details, refer to the [PROJECTOR SETUP] menu → [ECO MANAGEMENT] (➔ page 67).

Resetting to the factory default

Returns the settings for sub-menu or adjustment values to the factory default.



Press the <DEFAULT> button on the remote control.

Note

- Refer to “To reset to the factory default” (➔ page 43) for details.

Adjusting the volume

Adjusts the volume of the audio output.

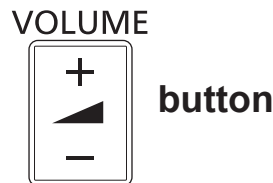

Press the <VOLUME +> or <VOLUME -> button on the remote control.

<VOLUME +>	Increases the volume.
<VOLUME ->	Decreases the volume.

Menu navigation

The on-screen menu (Menu) is used to perform various settings and adjustments of the projector.

Navigating through the menu

Operating procedure

MENU



button

1) Press the <MENU> button on the remote control or the control panel.

- The main menu screen is displayed.

PICTURE	PICTURE MODE	STANDARD
	CONTRAST	
POSITION	BRIGHTNESS	
	COLOR	
LANGUAGE	TINT	
	SHARPNESS	
DISPLAY OPTION	COLOR TEMPERATURE	
	DYNAMIC IRIS	ON
PROJECTOR SETUP	WAVEFORM MONITOR	
	ADVANCED MENU	
SECURITY	DAYLIGHT VIEW	AUTO
	DIGITAL CINEMA REALITY	
NETWORK	NOISE REDUCTION	
	RGB/Y _c /C _b	AUTO

2) Press ▲▼ to select the main menu item.

- The selected item is highlighted in yellow.
- The sub-menu of the selected main menu item is displayed on the right.

PICTURE	KEYSTONE	
	SHIFT	H: 0 V: 0
POSITION	OVER SCAN	
	ASPECT	NORMAL
LANGUAGE	FRAME LOCK	OFF
DISPLAY OPTION		
PROJECTOR SETUP		
SECURITY		
NETWORK		

3) Press the <ENTER> button.

- Sub-menu items become selectable.

4) Press ▲▼ to select the sub-menu item, then press ◀▶ to change the settings or adjust the parameter values.

- For some items, press ◀▶ to display an individual adjustment screen with a bar scale as shown in the following diagram.



- For items that are only names, pressing the <ENTER> button displays the next screen and advanced settings can be performed.

Note

- Pressing the <RETURN> or <MENU> button when the menu screen is displayed returns to the previous screen.
- Some items may not be adjusted or used for certain signal formats being input to the projector.
- Some items can be adjusted even if signals are not input.
- Individual adjustment screen is cleared automatically if no operation is performed for approximately five seconds.
- Refer to "Main menu" (➡ page 44) or "Sub menu" (➡ pages 44 to 45) regarding the menu items.

■ To reset to the factory default

If the <DEFAULT> button on the remote control is pressed, the values set or adjusted in the sub-menu items will be restored to the factory default settings.

DEFAULT button

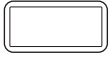

Press the <DEFAULT> button on the remote control.

This function differs depending on the screen displayed.

- When the sub-menu screen is displayed:
The sub-menu items displayed are returned to their default settings.
- When the individual adjustment screen is displayed:
Restores only the settings of the current item to the factory default settings.



Note



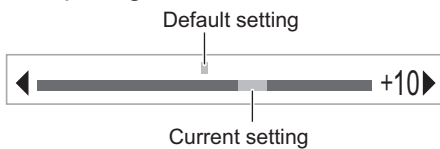



- To restore all the settings to the factory default, refer to the [PROJECTOR SETUP] menu → [INITIALIZE ALL] (➔ page 72).
- Some menu items cannot be reset by pressing the <DEFAULT> button. Adjust each item manually.
- The mark above the bar scale in the individual adjustment screen indicates the factory default setting. The position of the mark varies by the selected input signals.



Menu navigation

Main menu

There are following seven items in the main menu. When a main menu item is selected, the screen changes to a sub-menu selection screen.

Main menu item	Page
 [PICTURE]	44
 [POSITION]	44
 [LANGUAGE]	45
 [DISPLAY OPTION]	45
 [PROJECTOR SETUP]	45
 [SECURITY]	45
 [NETWORK]	45

Sub menu

The sub-menu screen of the selected main menu item is displayed, and you can set and adjust the various items in the sub-menu.

■ [PICTURE]

Sub-menu item	Factory default	Page
[PICTURE MODE]	[STANDARD]* ¹	46
[CONTRAST]	0	46
[BRIGHTNESS]	0	47
[COLOR]	0	47
[TINT]	0	47
[SHARPNESS]	0	47
[COLOR TEMPERATURE]	0	47
[DYNAMIC IRIS]	[ON]	48
[WAVEFORM MONITOR]	—	48
[ADVANCED MENU]	—	51
[DAYLIGHT VIEW]	[AUTO]	52
[DIGITAL CINEMA REALITY]	[ON]	52
[NOISE REDUCTION]	0* ¹	52
[TV-SYSTEM]* ¹	[AUTO]	53
[RGB/YC _B CR] ^{*1} , [RGB/YP _B PR] ^{*1}	[AUTO]	53

*1: Depends on the signal input.

Note

- The factory default settings may vary depending on the picture mode.
- Sub-menu items and factory default settings differ depending on the selected input terminal.

■ [POSITION]

Sub-menu item	Factory default	Page
[KEystone]	0	54
[SHIFT]	0	54
[DOT CLOCK]	0	55
[CLOCK PHASE]	0	55
[OVER SCAN]	0* ¹	56
[ASPECT]	[NORMAL]* ¹	56
[FRAME LOCK]	[OFF]	58

*1: Depends on the signal input.

Note

- Sub-menu items and factory default settings differ depending on the selected input terminal.

■ [LANGUAGE]

Details (➔ page 59)

■ [DISPLAY OPTION]

Sub-menu item	Factory default	Page
[ON-SCREEN DISPLAY]	—	60
[HDMI SIGNAL LEVEL]	—	61
[CLOSED CAPTION SETTING]	[OFF]	61
[STARTUP LOGO]	[DEFAULT LOGO]	62
[AUTO SETUP SETTING]	[AUTO]	62
[SIGNAL SEARCH]	[ON]	62
[BACK COLOR]	[BLUE]	63
[SXGA MODE]	[SXGA]	63
[OTHER FUNCTIONS]		63

■ [PROJECTOR SETUP]

Sub-menu item	Factory default	Page
[STATUS]	—	64
[PROJECTOR ID]	[ALL]	64
[INITIAL START UP]	[LAST MEMORY]	65
[PROJECTION METHOD]	[FRONT/DESK]	65
[HIGH ALTITUDE MODE]	[OFF]	65
[LAMP POWER]	[NORMAL]	66
[LAMP RUNTIME]	—	66
[SCHEDULE]	[OFF]	66
[ECO MANAGEMENT]	—	67
[EMULATE]	[DEFAULT]	69
[FUNCTION BUTTON]	—	69
[AUDIO SETTING]	—	70
[DATE AND TIME]	—	71
[TEST PATTERN]	—	72
[INITIALIZE ALL]	—	72

■ [SECURITY]

Sub-menu item	Factory default	Page
[PASSWORD]	[OFF]	73
[PASSWORD CHANGE]	—	73
[DISPLAY SETTING]	[OFF]	74
[TEXT CHANGE]	—	74
[MENU LOCK]	[OFF]	74
[MENU LOCK PASSWORD]	—	75
[CONTROL DEVICE SETUP]	—	75

■ [NETWORK]

Sub-menu item	Factory default	Page
[WIRED LAN]	—	76
[NAME CHANGE]	—	76
[NETWORK CONTROL]	[ON]	77
[STATUS]	—	77
[INITIALIZE]	—	77

[PICTURE] menu

Select [PICTURE] from the main menu, and select the item from the sub-menu. Refer to “Navigating through the menu” (➔ page 42) for the operation of the menu screen.

- After selecting the item, press ▲▼◀▶ to set.

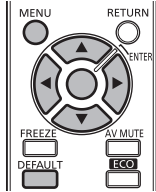

[PICTURE MODE]

You can switch to the desired picture mode suitable for the image source and the environment in which the projector is used.

- 1) Press ▲▼ to select [PICTURE MODE].
- 2) Press ◀▶ or press the <ENTER> button.
 - The [PICTURE MODE] individual adjustment screen is displayed.
- 3) Press ◀▶ to switch [PICTURE MODE].
 - The setting will change as follows each time you press the button.

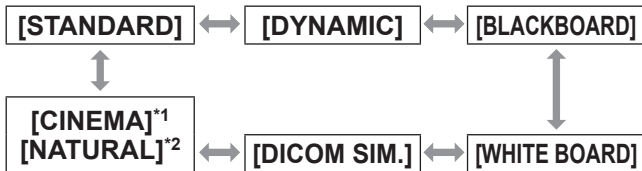

- *1: When movie-based signals are input
*2: When still image signals are input

[STANDARD]	The picture becomes suitable for moving images in general.
[DYNAMIC]	The light output is maximized for use in bright areas.
[BLACKBOARD]	The picture becomes suitable for projecting on a black board.
[WHITE BOARD]	The picture becomes suitable for projecting on a white board.
[DICOM SIM.]*1	The picture becomes similar to that of DICOM Part 14 Grayscale Standard.
[CINEMA]	The picture becomes suitable for movie sources.
[NATURAL]	The picture complies with sRGB.

- *1: Set the items other than [PICTURE MODE] to the factory default.

Note

- The factory default picture modes are [DYNAMIC] for still image input signals and [STANDARD] for movie-based input signals.
- DICOM, the abbreviation of “Digital Imaging and Communication in Medicine”, is a standard for medical imaging technology. Although the name DICOM is used in the setting item, this projector is not for a medical use. Do not use the projected images for diagnostic purposes.

[CONTRAST]

You can adjust the contrast of the colors.

- 1) Press ▲▼ to select [CONTRAST].
- 2) Press ◀▶ or press the <ENTER> button.
 - The [CONTRAST] individual adjustment screen is displayed.
- 3) Press ◀▶ to adjust the level.

Operation	Adjustment	Range
Press ▶ .	Brightens the screen and makes the color of image deeper.	Maximum value +64
Press ◀ .	Darkens the screen and makes the color of image lighter.	Minimum value -64

Attention

- Adjust [BRIGHTNESS] first when you need to adjust [BRIGHTNESS] and [CONTRAST].

[BRIGHTNESS]

You can adjust the dark (black) part of the projected image.

- 1) Press ▲▼ to select [BRIGHTNESS].
- 2) Press ◀▶ or press the <ENTER> button.
 - The [BRIGHTNESS] individual adjustment screen is displayed.
- 3) Press ◀▶ to adjust the level.

Operation	Adjustment	Range
Press ▶ .	Increases the brightness of the dark (black) parts of the screen.	Maximum value +32
Press ◀ .	Reduces the brightness of the dark (black) parts of the screen.	Minimum value -32

[COLOR]

You can adjust the color saturation of the projected image.

- 1) Press ▲▼ to select [COLOR].
- 2) Press ◀▶ or press the <ENTER> button.
 - The [COLOR] individual adjustment screen is displayed.
- 3) Press ◀▶ to adjust the level.

Operation	Adjustment	Range
Press ▶ .	Deepens colors.	Maximum value +32
Press ◀ .	Weakens colors.	Minimum value -32

[TINT]

You can adjust the skin tone in the projected image.

- 1) Press ▲▼ to select [TINT].
- 2) Press ◀▶ or press the <ENTER> button.
 - The [TINT] individual adjustment screen is displayed.
- 3) Press ◀▶ to adjust the level.

Operation	Adjustment	Range
Press ▶ .	Adjusts skin tone toward greenish color.	Maximum value +32
Press ◀ .	Adjusts skin tone toward reddish purple.	Minimum value -32

[SHARPNESS]

You can adjust the sharpness of the projected image.

- 1) Press ▲▼ to select [SHARPNESS].
- 2) Press ◀▶ or press the <ENTER> button.
 - The [SHARPNESS] individual adjustment screen is displayed.
- 3) Press ◀▶ to adjust the level.

Operation	Adjustment	Range
Press ▶ .	Contours become sharper.	Depends on the signal input.
Press ◀ .	Contours become softer.	

[COLOR TEMPERATURE]

You can switch the color temperature if the white areas of the projected image are bluish or reddish.

- 1) Press ▲▼ to select [COLOR TEMPERATURE].
- 2) Press ◀▶ or press the <ENTER> button.
 - The [COLOR TEMPERATURE] individual adjustment screen is displayed.
- 3) Press ◀▶ to adjust the level.

Operation	Adjustment	Range
Press ▶ .	Reduces red color of the projected image.	Maximum value +6
Press ◀ .	Reduces blue color of the projected image.	Minimum value -6

[PICTURE] menu

[DYNAMIC IRIS]

You can switch automatic adjustment of the lamp and the lens iris on/off. This augments the video to create a video expression with sharp contrast between light and shade.

- 1) Press ▲▼ to select [DYNAMIC IRIS].
- 2) Press ◀▶ or press the <ENTER> button.
 - The [DYNAMIC IRIS] individual adjustment screen is displayed.
- 3) Press ◀▶ to switch [DYNAMIC IRIS].
 - The setting will change as follows each time you press the button.

[ON]	↔	[OFF]
[ON]	Enables [DYNAMIC IRIS].	
[OFF]	Disables [DYNAMIC IRIS].	

[WAVEFORM MONITOR]

By using a commercial test disk etc. and setting the luminance level of the output (luminance) signal from a connected external device to a value within this projector's recommended range, you can adjust so the display performance of the projector can be fully leveraged.

- 1) Press ▲▼ to select [WAVEFORM MONITOR].
- 2) Press the <ENTER> button.
 - The [WAVEFORM MONITOR] screen is displayed.

WAVEFORM MONITOR	
● OFF	
FULL SCAN(Y)	
FULL SCAN(R)	
FULL SCAN(G)	
FULL SCAN(B)	
SINGLE LINE SCAN(Y)	
SINGLE LINE SCAN(R)	
SINGLE LINE SCAN(G)	
SINGLE LINE SCAN(B)	
MONITOR POSITION	UPPER RIGHT
AUTO ADJUST	

- 3) Press ▲▼ to select an adjustment item, and press the <ENTER> button.
 - The waveform monitor is displayed.

[OFF]	Closes the waveform monitor.
[FULL SCAN(Y)] [FULL SCAN(R)] [FULL SCAN(G)] [FULL SCAN(B)]	Checks whether each waveform of (Y - luminance), (R - red), (G - green), and (B - blue) for the whole image falls within a recommended range.
[SINGLE LINE SCAN(Y)] [SINGLE LINE SCAN(R)] [SINGLE LINE SCAN(G)] [SINGLE LINE SCAN(B)]	Checks whether each waveform of (Y - luminance), (R - red), (G - green), and (B - blue) falls within a recommended range at any horizontal lines from the upper to the bottom of the screen. <ul style="list-style-type: none"> ● Press ▲▼ to move the line position. ● The waveform monitor position changes depending on a line position.
[MONITOR POSITION]	Sets the display position for the input waveform at the full scan.
[AUTO ADJUST]	Set the automatic waveform adjustment items to automatically adjust the luminance level of the output signal from a connected external device.

Note

- Signals lower than 0% in the waveform monitor will be displayed as same as 0% on the projected image.
- [SINGLE LINE SCAN(Y)], [SINGLE LINE SCAN(R)], [SINGLE LINE SCAN(G)], and [SINGLE LINE SCAN(B)] can display horizontal lines in Y - (luminance), R - (red), G - (green), and B - (blue) from the top of the screen to the bottom more finely than [FULL SCAN(Y)], [FULL SCAN(R)], [FULL SCAN(G)], and [FULL SCAN(B)] and each item can be adjusted in the same way as [FULL SCAN(Y)], [FULL SCAN(R)], [FULL SCAN(G)], and [FULL SCAN(B)].
- When selecting [SINGLE LINE SCAN(Y)], [SINGLE LINE SCAN(R)], [SINGLE LINE SCAN(G)], or [SINGLE LINE SCAN(B)], the display position of the waveform can be set using ▲▼◀▶.
- So that the display of individual adjustment screen in [PICTURE] does not interfere with the waveform monitor, the positioning of this screen differs depending on the circumstances at the time.
- [AUTO ADJUST] is executed by pressing the <DEFAULT> button while the waveform is displayed. (➡ page 50)

To adjust the waveform

Project the brightness adjustment signal of a commercial test disk (0% (0 IRE or 7.5 IRE) - 100% (100 IRE)) and perform adjustment.

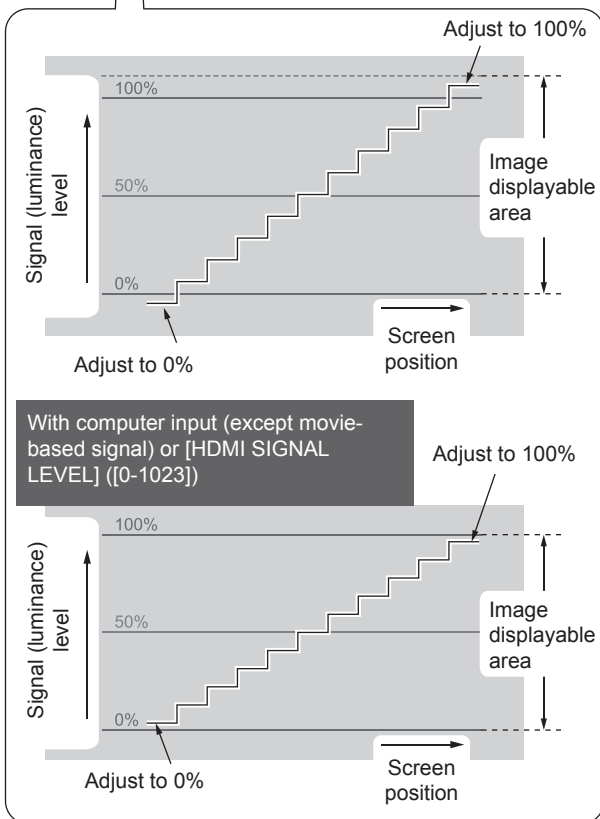
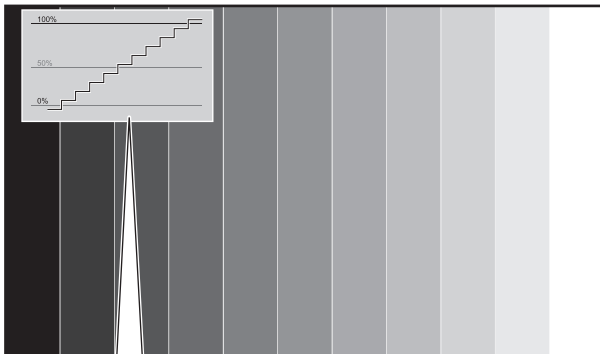

While the waveform monitor is displayed, press the <MENU> button to adjust the waveform using [PICTURE] of the main menu item and [ADVANCED MENU] of the sub-menu item.

1) Adjust [FULL SCAN(Y)]/[SINGLE LINE SCAN(Y)].

- Select the [PICTURE] menu and press ◀▶ to adjust [BRIGHTNESS] and then [CONTRAST].

[BRIGHTNESS]	Adjusts the black level of the display signal to 0% (0 IRE or 7.5 IRE). ● Setting range -32 to +32
[CONTRAST]	Adjusts the white level of the display signal to 100% (100 IRE). ● Setting range -64 to +64

2) Adjust [FULL SCAN(R)]/[SINGLE LINE SCAN(R)].

- Select the [PICTURE] menu → [ADVANCED MENU] and press ◀▶ to adjust [BRIGHTNESS R] and then [CONTRAST R].

[BRIGHTNESS R]	Adjusts the black level of the display signal to 0% (0 IRE or 7.5 IRE). ● Setting range -16 to +16
[CONTRAST R]	Adjusts the white level of the display signal to 100% (100 IRE). ● Setting range -32 to +32

3) Adjust [FULL SCAN(G)]/[SINGLE LINE SCAN(G)].

- Select the [PICTURE] menu → [ADVANCED MENU] and press ◀▶ to adjust [BRIGHTNESS G] and then [CONTRAST G].

[BRIGHTNESS G]	Adjusts the black level of the display signal to 0% (0 IRE or 7.5 IRE). ● Setting range -16 to +16
[CONTRAST G]	Adjusts the white level of the display signal to 100% (100 IRE). ● Setting range -32 to +32

[PICTURE] menu

4) Adjust [FULL SCAN(B)]/[SINGLE LINE SCAN(B)].

- Select the [PICTURE] menu → [ADVANCED MENU] and press ◀▶ to adjust [BRIGHTNESS B] and then [CONTRAST B].

[BRIGHTNESS B]	Adjusts the black level of the display signal to 0% (0 IRE or 7.5 IRE). ● Setting range -16 to +16
[CONTRAST B]	Adjusts the white level of the display signal to 100% (100 IRE). ● Setting range -32 to +32

■ To set [MONITOR POSITION]

You can set the display position of the input waveform during the full scan display.

Press ◀▶ to switch [MONITOR POSITION].

- The setting will change as follows each time you press the button.

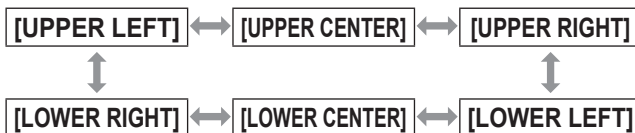

[UPPER LEFT]	Displays the input waveform on the upper left.
[UPPER CENTER]	Displays the input waveform on the upper center.
[UPPER RIGHT]	Displays the input waveform on the upper right.
[LOWER LEFT]	Displays the input waveform on the lower left.
[LOWER CENTER]	Displays the input waveform on the lower center.
[LOWER RIGHT]	Displays the input waveform on the lower right.

■ To set [AUTO ADJUST]

The luminance level of the output signal from a connected external device is automatically adjusted by setting the automatic waveform adjustment items.

1) Press ▲▼ to select an adjustment item.

Automatic waveform adjustment items	Factory default
[START AUTO ADJUST]	—
[BLACK LEVEL ADJUST]	[ON]
[WHITE LEVEL ADJUST]	[ON]
[RGB ADJUST (BLACK)]	[OFF]
[RGB ADJUST (WHITE)]	[OFF]

2) Press ◀▶ to switch the adjustment.

3) Press ▲▼ to select [START AUTO ADJUST], and press the <ENTER> button.

- The [PROCESSING] message is displayed. When adjustment is complete, a confirmation message for applying results is displayed.

4) Press ◀▶ to select [OK].

5) Press the <ENTER> button.

Note

- When [BLACK LEVEL ADJUST] is [ON], the display signal Y (brightness) value's black level is automatically adjusted to the 0% position.
- When [WHITE LEVEL ADJUST] is [ON], the display signal Y (brightness) value's white level is automatically adjusted to the 100% position.
- When [RGB ADJUST (BLACK)] is [ON], the display signal R (Red), G (Green), and B (Blue) value's black level are all automatically adjusted to the 0% position.
- When [RGB ADJUST (WHITE)] is [ON], the display signal R (Red), G (Green), and B (Blue) value's white level are all automatically adjusted to the 100% position.
- If [WAVEFORM MONITOR] is [OFF], [AUTO ADJUST] cannot be executed.
- Project the luminance adjustment signal of a commercial test disk etc., and perform automatic adjustment. However, even with an adjustment disk, correct adjustment may not be possible if noise is included on the disk itself or the playback device generates noise.

- [AUTO ADJUST] adjusts based on the 0% and 100% standard signal within the screen. Correct adjustment cannot be performed if standard signals are not displayed on the screen because of overscan etc., or if a signal that is less than 0% or greater than 100% is displayed on the screen.

[ADVANCED MENU]

You can perform more detailed adjustment in video images.

- 1) Press ▲▼ to select [ADVANCED MENU].
- 2) Press the <ENTER> button.
 - The [ADVANCED MENU] screen is displayed.
- 3) Press ▲▼ to select [CONTRAST R] to [BRIGHTNESS B].
- 4) Press ◀▶ or press the <ENTER> button.
 - The individual adjustment screen for each item is displayed.
- 5) Press ◀▶ to adjust the level.

[CONTRAST R]

Operation	Adjustment	Range
Press ▶ .	Emphasizes red in highlight areas.	Maximum value +32
Press ◀ .	Deemphasizes red in highlight areas.	Minimum value -32

[CONTRAST G]

Operation	Adjustment	Range
Press ▶ .	Emphasizes green in highlight areas.	Maximum value +32
Press ◀ .	Deemphasizes green in highlight areas.	Minimum value -32

[CONTRAST B]

Operation	Adjustment	Range
Press ▶ .	Emphasizes blue in highlight areas.	Maximum value +32
Press ◀ .	Deemphasizes blue in highlight areas.	Minimum value -32

[BRIGHTNESS R]

Operation	Adjustment	Range
Press ▶ .	Emphasizes red in shadow areas.	Maximum value +16
Press ◀ .	Deemphasizes red in shadow areas.	Minimum value -16

[BRIGHTNESS G]

Operation	Adjustment	Range
Press ▶ .	Emphasizes green in shadow areas.	Maximum value +16
Press ◀ .	Deemphasizes green in shadow areas.	Minimum value -16

[BRIGHTNESS B]

Operation	Adjustment	Range
Press ▶ .	Emphasizes blue in shadow areas.	Maximum value +16
Press ◀ .	Deemphasizes blue in shadow areas.	Minimum value -16

[PICTURE] menu

[DAYLIGHT VIEW]

You can correct the image to the optimal vividness even if it is projected under a bright light.

- 1) Press ▲▼ to select [DAYLIGHT VIEW].
- 2) Press ◀▶ or press the <ENTER> button.
 - The [DAYLIGHT VIEW] individual adjustment screen is displayed.
- 3) Press ◀▶ to switch [DAYLIGHT VIEW].
 - The setting will change as follows each time you press the button.



[AUTO]	Enables auto correction of [DAYLIGHT VIEW]. The color sensor detects the brightness and color of the surroundings and automatically corrects the video display.
[ON]	Enables [DAYLIGHT VIEW].
[OFF]	Disables [DAYLIGHT VIEW].

Note

- You cannot set [AUTO] if [REAR/DESK] or [REAR/CEILING] is selected for [PROJECTION METHOD] of [PROJECTOR SETUP].
- The [AUTO] mode may not function properly if an object is placed on the top of the projector.

[DIGITAL CINEMA REALITY]

You can improve the vertical resolution of 2-2 and 2-3 pull-down video.

This function is available only with the following signal inputs.

525i (480i), 625i (576i), 1125 (1080)/60i, 1125 (1080)/50i, S-video signal, video signal

- 1) Press ▲▼ to select [DIGITAL CINEMA REALITY].
- 2) Press ◀▶ or press the <ENTER> button.
 - The [DIGITAL CINEMA REALITY] individual adjustment screen is displayed.
- 3) Press ◀▶ to switch [DIGITAL CINEMA REALITY].
 - The setting will change as follows each time you press the button.



[ON]	Enables [DIGITAL CINEMA REALITY].
[OFF]	Disables [DIGITAL CINEMA REALITY].

[NOISE REDUCTION]

You can reduce noises when the input image is degraded and noise is occurring in the image signal.

- 1) Press ▲▼ to select [NOISE REDUCTION].
- 2) Press ◀▶ or press the <ENTER> button.
 - The [NOISE REDUCTION] individual adjustment screen is displayed.
- 3) Press ◀▶ to adjust the level.

Operation	Adjustment	Range
Press ▶ .	Strengthen the noise reduction.	Maximum value +3
Press ◀ .	Weakens the noise reduction.	Minimum value 0

Attention

- When this is set for an input signal with less noise, the image may look different from what it originally was. In such case, set the value to 0.

[TV-SYSTEM]

● Only when the <S-VIDEO IN>/<VIDEO IN> terminal is selected

The projector will automatically detect the input signal, but if you input an unstable signal, you can set the color system manually. Set the color system that matches the input mode.

- 1) Press ▲▼ to select [TV-SYSTEM].
- 2) Press ◀▶ or press the <ENTER> button.
 - The [TV-SYSTEM] screen is displayed.
- 3) Press ◀▶ to select the color system.
 - The setting will change as follows each time you press the button.

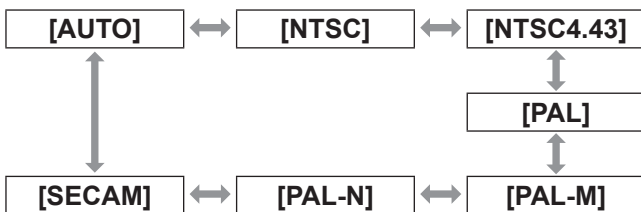

Attention

- Set it to [AUTO] normally.
- Switch the setting to the color system for the TV used.

Note

- Setting [AUTO] will automatically select [NTSC], [NTSC4.43], [PAL], [PAL-M], [PAL-N], [SECAM], or [PAL60].

[RGB/YC_BC_R]/[RGB/YP_BP_R]

Set it to [AUTO] normally. If images are not displayed correctly when this is set to [AUTO], set either [RGB] or [YC_BC_R], [YP_BP_R] in accordance with the input signal.

- 1) Press ▲▼ and select [RGB/YC_BC_R] or [RGB/YP_BP_R].
- 2) Press ◀▶ or press the <ENTER> button.
 - The individual adjustment screen of [RGB/YC_BC_R] or [RGB/YP_BP_R] is displayed.
- 3) Press ◀▶ to switch the setting.
 - The setting will change as follows each time you press the button.



[AUTO]	The sync signal automatically selects the signal [RGB]/[YC _B C _R]/[YP _B P _R].
[RGB]	Select it for RGB signal input.
[YP _B P _R]	Select it for YP _B P _R signal input.
[YC _B C _R]	Select it for YC _B C _R signal input.

■ When the <COMPUTER IN> terminal is selected

- For 525i (480i), 625i (576i), 525p (480p), 625p (576p), and VGA60 input
Select [AUTO], [RGB], or [YC_BC_R].
- For other movie-based signal input
Select [AUTO], [RGB], or [YP_BP_R].

■ When the <HDMI IN 1>/<HDMI IN 2> terminal is selected

- For 525p (480p) and 625p (576p) input
Select [AUTO], [RGB], or [YC_BC_R].
- For other movie-based signal input
Select [AUTO], [RGB], or [YP_BP_R].

Note

- Refer to “List of compatible signals” (➡ page 114) for the signal details.
- The signal selection may not function properly depending on connected devices.
- If the <COMPONENT IN> terminal is selected, the setting cannot be configured.

[POSITION] menu

Select [POSITION] from the main menu, and select the item from the sub-menu. Refer to “Navigating through the menu” (➔ page 42) for the operation of the menu screen.

- After selecting the item, press ▲▼◀▶ to set.

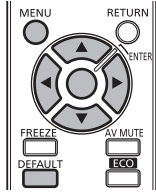

[KEYSTONE]

You can correct the trapezoidal distortion that occurs when the projector is installed tilted or when the screen is tilted.

- 1) Press ▲▼ to select [KEYSTONE].
- 2) Press ◀▶ or press the <ENTER> button.
 - The [KEYSTONE] individual adjustment screen is displayed.
- 3) Press ▲▼◀▶ to correct the distortion.

Operation	Adjustment
Press ▲ or ▶ .	
Press ▼ or ◀ .	

- Setting range: -32 to +32

Note

- You can correct the distortion $\pm 30^\circ$ from the vertical plane. However, the picture quality will degrade and it will get harder to focus with more correction. Install the projector so the correction will be as small as possible.
- Image size will also change when [KEYSTONE] is performed.
- Trapezoidal distortion may occur depending on the lens shift position.
- Aspect ratio of the image size may shift depending on the correction or lens zoom value.

[SHIFT]

You can move the image position vertically or horizontally if the image position projected on the screen is shifted even when the relative position of the projector and the screen is installed correctly.

- 1) Press ▲▼ to select [SHIFT].
- 2) Press the <ENTER> button.
 - The [SHIFT] individual adjustment screen is displayed.
- 3) Press ▲▼◀▶ to adjust the position.

Note

- You can also press ▲▼◀▶ directly to operate this function.

■ For vertical (up and down) adjustment

Operation	Adjustment
Press ▲ .	The picture position moves up.
Press ▼ .	The picture position moves down.

■ For horizontal (right and left) adjustment

Operation	Adjustment
Press ▶ .	The picture position moves to the right.
Press ◀ .	The picture position moves to the left.

[DOT CLOCK]**● Only for computer (RGB) signal input**

Use this function to adjust and minimize the effect of interference caused by projection of patterns consisting of vertical stripes.

The projection of the following striped pattern may cause cyclic patterns (noise). Adjust so that the amount of interference is at a minimum.

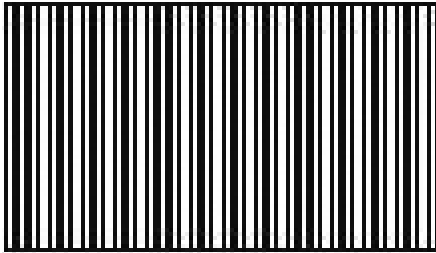

- 1) Press ▲▼ to select [DOT CLOCK].
- 2) Press ◀▶ or press the <ENTER> button.
 - The [DOT CLOCK] individual adjustment screen is displayed.
- 3) Press ◀▶ to adjust the level.
 - The adjustment values are -32 to +32.

Note

- Dot clock adjustment is feasible for computer (RGB) signal input other than 525i (480i), 625i (576i), 525p (480p), and 625p (576p).

Attention

- Set it before adjusting [CLOCK PHASE].

[CLOCK PHASE]

You can adjust to achieve an optimal image when there is a flickering image or smeared outlines.

- 1) Press ▲▼ to select [CLOCK PHASE].
- 2) Press ◀▶ or press the <ENTER> button.
 - The [CLOCK PHASE] individual adjustment screen is displayed.
- 3) Press ◀▶ to adjust the level.
 - Adjustment value will change between 0 and +31. Adjust so that the amount of interference is at a minimum.

Note

- Optimal value may not be achieved if the output from the input computer is unstable.
- To project a signal with dot clock frequency with 162 MHz or higher, noise may not disappear even if [CLOCK PHASE] is adjusted.
- Adjustment is not available when a 525i (480i) or 625i (576i) component (Y_CB_CR) signal is input.
- Adjustment is not available when a 525i (480i) or 625i (576i) computer (RGB) signal is input.
- [CLOCK PHASE] cannot be adjusted when a digital signal is input.

[POSITION] menu

[OVER SCAN]

Use the following steps to make adjustments when text and images on the periphery of the projected image are not properly displayed.

- 1) Press ▲▼ to select [OVER SCAN].
- 2) Press ◀▶ or press the <ENTER> button.
 - The [OVER SCAN] individual adjustment screen is displayed.
- 3) Press ◀▶ to adjust the level.
 - The adjustment values are 0 to +10.

Note

- This item is not available for still image computer (RGB) signals.

[ASPECT]

You can switch the aspect ratio of the image.

- 1) Press ▲▼ to select [ASPECT].
- 2) Press ◀▶ or press the <ENTER> button.
 - The [ASPECT] individual adjustment screen is displayed.
- 3) Press ◀▶ to switch the setting.
 - The setting will change as follows each time you press the button.

■ When S-video/video signal is input

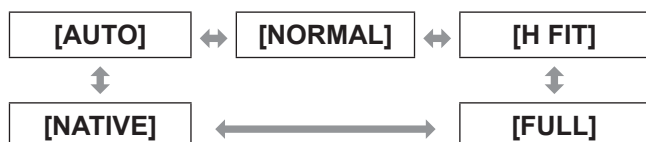

Note

- [AUTO] is enabled only when an NTSC signal is input for both S-video and video signals.

■ When still image computer (RGB) signal is input

● For 1280 x 720 input

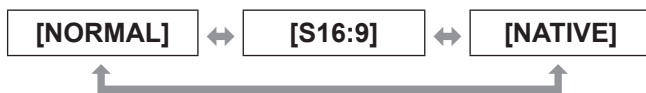

● For VGA70, VGA85, 1280 x 768, 1280 x 800, WXGA+, or WSXGA+ signal input

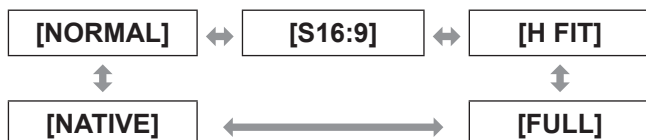

● For WUXGA input



● For other still image computer (RGB) signal input



*1: UXGA cannot be switched to [NATIVE].

■ When HDMI signal is input

● For 1125 (1080)/60i, 1125 (1080)/50i, 1125 (1080)/60p, 1125 (1080)/50p, 1125 (1080)/24p input



● For 750 (720)/60p, 750 (720)/50p input

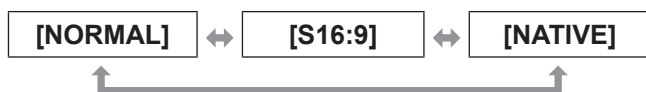

● For 525p (480p), 625p (576p) input



■ For component (YCbCr/YPr) signal/movie-based computer (RGB) signal input

- For 1125 (1080)/60i, 1125 (1080)/50i, 1125 (1080)/60p, 1125 (1080)/50p, 1125 (1080)/24p input



- For 750 (720)/60p, 750 (720)/50p input

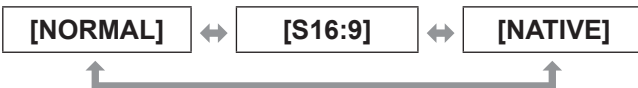

- For 525i (480i) (YCbCr) input

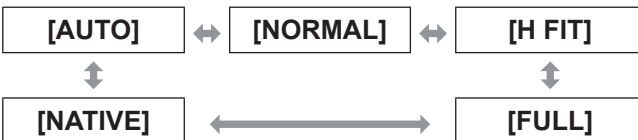

- For 525i (480i) (RGB), 625i (576i), 525p (480p), 625p (576p) input



Attention

- If a 4:3 aspect video is projected at [FULL] aspect ratio, the shape of the image may change or the edges may not be visible. Project videos intended by the author at the original aspect ratio.

Note

- Some aspect ratios may not be available depending on the input signal.
- If an aspect ratio which is different from the aspect ratio for the input signals is selected, the pictures will appear differently from the originals.
- If you project a copyrighted image enlarged or distorted by using this function in commercial use in a public place, such as a restaurant or hotel, you might infringe on the copyright of the creator which is protected by copyright law.
- When set to [AUTO], the aspect ratio is automatically switched to the optimum aspect ratio when an aspect ratio identifier is included in the input signal.
- [AUTO] may not be displayed if input signal is S-video, video, or component (YCbCr/YPr).
- A black area may appear at the top and bottom of the screen when videos that are wider than 16:9 (cinema vision etc.) are projected.

Aspect ratio	Screen
<p>[NORMAL] Projects the whole image while preserving original ratio, using all of either horizontal or vertical panel pixels.</p>	<p>Input signal</p> <p>↓</p> <p>Projection screen</p>
<p>[S16:9] Projects a 16:9 aspect video onto a 4:3 aspect screen.</p>	<p>Input signal</p> <p>↓</p> <p>Projection screen</p>

[POSITION] menu

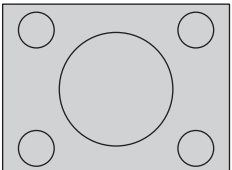
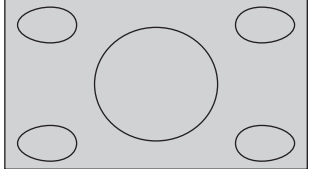
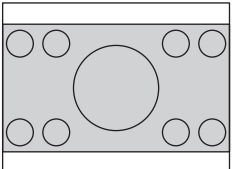
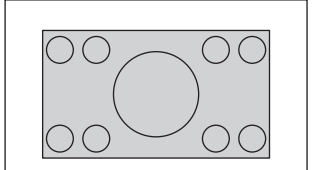
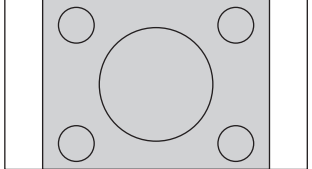
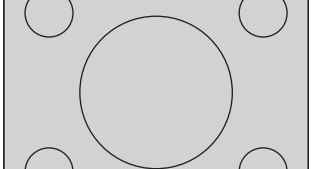
Aspect ratio	Screen
<p>[FULL] The image is projected using all the panel (screen) pixels. The input signals are converted to the aspect ratio of the panel (screen).</p>	<p>Input signal</p>  <p>↓</p> <p>Projection screen</p> 
<p>[NATIVE] The image is projected without size adjustment, keeping the resolution of the input signals.</p>	<p>Input signal</p>  <p>↓</p> <p>Projection screen</p> 
<p>[H FIT] While the aspect ratio is kept fixed, The image is projected using all the panel pixels horizontally, and the vertical edges of the image are cropped.</p>	<p>Input signal</p>  <p>↓</p> <p>Projection screen</p> 

[FRAME LOCK]

● **Only for computer (RGB) or HDMI signal input**

This setting is available for specific computer signals. Set when the movie is distorted.

- 1) Press ▲▼ to select **[FRAME LOCK]**.
- 2) Press ◀▶ or press the <ENTER> button.
 - The **[FRAME LOCK]** individual adjustment screen is displayed.
- 3) Press ◀▶ to switch **[FRAME LOCK]**.
 - The setting will change as follows each time you press the button.



[OFF]	Disables the frame lock.
[ON]	Enables the frame lock.

[LANGUAGE] menu

Select [LANGUAGE] from the main menu, and display the sub-menu.

Refer to “Navigating through the menu” (▶ page 42) for the operation of the menu screen.

- Press ▲▼ to select the language, and press the <ENTER> button to set.

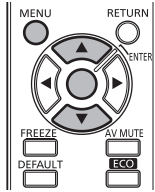

Changing the display language

You can select the language of the on-screen display.

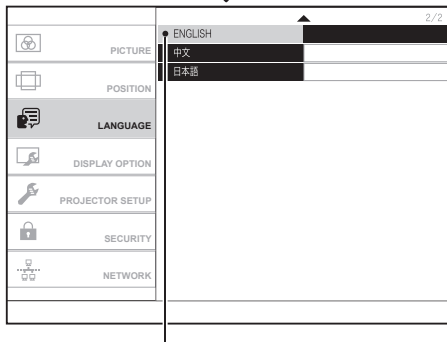
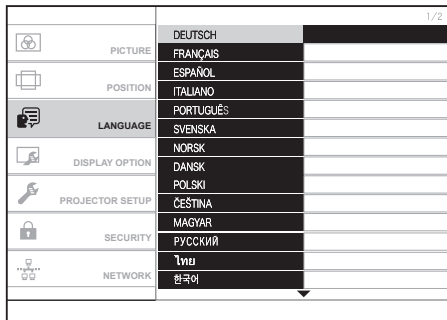

Displayed in a chosen language

- Various menus, settings, adjustment screens, control button names, etc., are displayed in the selected language.
- On-screen display is available in the following languages: German, French, Spanish, Italian, Portuguese, Swedish, Norwegian, Danish, Polish, Czech, Hungarian, Russian, Thai, Korean, English, Chinese, and Japanese.

[DISPLAY OPTION] menu

Select [DISPLAY OPTION] from the main menu, and select the item from the sub-menu. Refer to “Navigating through the menu” (➔ page 42) for the operation of the menu screen.

- After selecting the item, press ▲▼◀▶ to set.

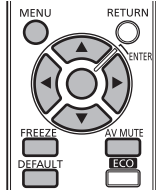

[ON-SCREEN DISPLAY]

You can set the on-screen display.

- 1) Press ▲▼ to select [ON-SCREEN DISPLAY].
- 2) Press the <ENTER> button.
 - The [ON-SCREEN DISPLAY] screen is displayed.
- 3) Press ▲▼ to select an item, and press ◀▶ to change the setting.

■ [INPUT GUIDE]

You can set the display method of the name of the input terminal displayed on the top right of the projection screen.

- The setting will change as follows each time you press the button.



[DETAILED]	Displays the input terminal graphically.
[OFF]	Disables the input guide.
[SIMPLE]	Displays the name of input terminal currently selected.

Note

- While set to [DETAILED], if signals are not input to the <COMPUTER IN> terminal or <HDMI IN 1>/<HDMI IN 2> terminal, a guidance appears to connect with a computer is displayed. To disable the guidance, select [SIMPLE] or [OFF].

● Computer connection guidance

Refer to the following table for key commands on the computer for switching the image output.

Manufacturer	Key command to switch the image
Panasonic	Fn + F3
SAMSUNG	Fn + F4
acer SHARP TOSHIBA	Fn + F5
lenovo LG SONY	Fn + F7
EPSON	Fn + F8
FUJITSU	Fn + F10
NEC	Fn + F3 / F5
HP	Fn + F4 / F5
DELL	Fn + F1 / F8
Apple	F7 / Command + F2

Note

- Since the method varies depending on the computer type, refer to the user manual of your computer.

■ [OSD DESIGN]

You can set the color of the menu screen (OSD).

- The setting will change as follows each time you press the button.



[TYPE1]	Sets the background color to black.
[TYPE2]	Sets the background color to blue.

■ [WARNING MESSAGE]

You can set the display/hide of the warning message.

- The setting will change as follows each time you press the button.



[ON]	Displays the warning message.
[OFF]	Hides the warning message.

[HDMI SIGNAL LEVEL]

You can switch the setting when the projector is connected to an external equipment via HDMI cable and the image is not projected correctly.

1) Press ▲▼ to select [HDMI SIGNAL LEVEL].

2) Press ◀▶ to switch [HDMI SIGNAL LEVEL].

- The setting will change as follows each time you press the button.



[0-1023]	Select when the HDMI terminal and DVI-D output terminal of an external equipment (computer, etc.) is connected to the <HDMI IN 1>/<HDMI IN 2> terminal of the projector using a conversion cable, etc.
[64-940]	Select when the HDMI output terminal of an external equipment (DVD player, etc.) is connected to the <HDMI IN 1>/<HDMI IN 2> terminal of the projector.

Note

- The optimal setting is different depending on the output setting of the connected external equipment. Refer to the instruction manual of the external equipment regarding the output of the external equipment.

[CLOSED CAPTION SETTING]

● Only for NTSC, 525i (480i) input

Set the closed caption display as follows.

1) Press ▲▼ to select [CLOSED CAPTION SETTING].

2) Press the <ENTER> button.

- The [CLOSED CAPTION SETTING] screen is displayed.

3) Press ▲▼ to select an item, and press ◀▶ to change the setting.

■ [CLOSED CAPTION]

Set whether or not to display the closed caption.

- The setting will change as follows each time you press the button.
- When you set the function to [ON], a confirmation message [If the input matches the CC type selected,] [the SECURITY TEXT/LOGO will not be displayed.] appears. Select [OK] or [CANCEL] and press the <ENTER> button. You cannot set [ON] if [CANCEL] is selected.



[OFF]	Hides the closed caption.
[ON]	Displays the closed caption.

■ [MODE]

Selects a closed caption mode.

- The setting will change as follows each time you press the button.

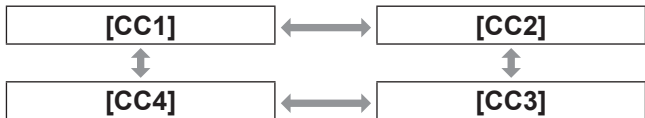

[CC1]	Displays CC1 data.
[CC2]	Displays CC2 data.
[CC3]	Displays CC3 data.
[CC4]	Displays CC4 data.

Note

- The closed caption is a function mainly used in the north America, and it shows the text information contained in the image signal. Closed captions may not be displayed on some devices or contents.
- Security messages set in the [SECURITY] menu → [DISPLAY SETTING] (➡ page 74) are not displayed when the closed caption signal of the selected mode is input.
- Part of characters may not be displayed when high compensation values are set in [KEYSTONE].
- Closed captions are not displayed while the menu screen is displayed.

[DISPLAY OPTION] menu

[STARTUP LOGO]

You can set the logo display when the power is turned on.

- 1) Press ▲▼ to select [STARTUP LOGO].
- 2) Press ◀▶ to switch [STARTUP LOGO].
 - The setting will change as follows each time you press the button.



[DEFAULT LOGO]	Projects the Panasonic logo.
[USER LOGO]	Projects the logo transferred with "Logo Transfer Software"*1.
[OFF]	Disables the startup logo display.

*1: "Logo Transfer Software" is included in the attached CD-ROM.

Note

- To create the image for [USER LOGO], "Logo Transfer Software" included in the supplied CD-ROM is required.
- The startup logo will disappear in approximately 30 seconds.
- The startup logo is not displayed even when [USER LOGO] is selected, if the log has not been transferred with "Logo Transfer Software".

[AUTO SETUP SETTING]

You can set the auto setup function. Set it to [AUTO] normally.

- 1) Press ▲▼ to select [AUTO SETUP SETTING].
- 2) Press ◀▶ to switch [AUTO SETUP SETTING].
 - The setting will change as follows each time you press the button.



[AUTO]	Enables the auto setup function when the projected signals are switched to the computer signals.
[BUTTON]	Enables the auto setup function only when the <AUTO SETUP> button is pressed.(➡ page 40)

Note

- This setting is enabled only when computer or HDMI signal is input.

[SIGNAL SEARCH]

When the power is turned on, this function automatically detects the terminal to which signals are input and sets the function to switch.

- 1) Press ▲▼ to select [SIGNAL SEARCH].
- 2) Press ◀▶ to switch [SIGNAL SEARCH].
 - The setting will change as follows each time you press the button.



[ON]	Enables input detection.
[OFF]	Disables input detection.

Note

- If [ON] is set and you press the <AUTO SETUP> button on the remote control when the selected input is no signal, the terminal to which a signal is input is automatically detected and switched.

[BACK COLOR]

You can set the color of the projected image when there is no signal input.

- 1) Press ▲▼ to select [BACK COLOR].
- 2) Press ◀▶ to switch [BACK COLOR].
 - The setting will change as follows each time you press the button.

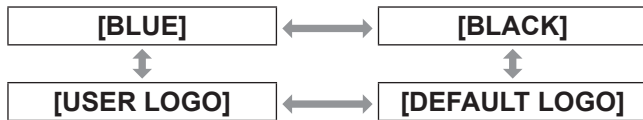

[BLUE]	The entire projection area appears blue.
[BLACK]	The entire projection area appears black.
[DEFAULT LOGO]	Projects the Panasonic logo.
[USER LOGO]	Projects the logo transferred with "Logo Transfer Software" ^{*1} .

*1: "Logo Transfer Software" is included in the attached CD-ROM.

[SXGA MODE]

This function is used if the whole projected image is not displayed when SXGA signal is input. Set it to [SXGA] normally.

- 1) Press ▲▼ to select [SXGA MODE].
- 2) Press ◀▶ to switch [SXGA MODE].
 - The setting will change as follows each time you press the button.



[SXGA]	When [SXGA] is set and the whole projected image is displayed
[SXGA+]	When [SXGA] is set and the whole projected image is not displayed

[OTHER FUNCTIONS]

■ [AUTO SETUP]

Refer to "Using the Automatic setup function" (➔ page 40) for details.

■ [FREEZE]

You can freeze the projected image and stop the sound temporarily, regardless of the playing condition of the external device. To release the setting, press the <RETURN> button or the <FREEZE> button on the remote control.

■ [AV MUTE]

You can stop the projection and the sound when you will not be using the projector for a while. To release the setting, press the <RETURN> button or the <AV MUTE> button on the remote control.

[PROJECTOR SETUP] menu

Select [PROJECTOR SETUP] from the main menu, and select the item from the sub-menu. Refer to “Navigating through the menu” (➡ page 42) for the operation of the menu screen.

- After selecting the item, press ▲▼◀▶ to set.

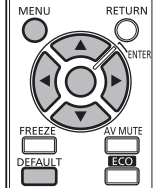

[STATUS]

You can display the projector status.

- 1) Press ▲▼ to select [STATUS].
- 2) Press the <ENTER> button.
 - The [STATUS] screen is displayed.

[SIGNAL]

[NAME]	Displays the input signal name.
[FREQUENCY]	Displays the frequency of the input signal.

[RUNTIME]

[PROJECTOR]	Displays the operation times of the projector.
[LAMP]	Displays the status and the lamp actual usage time for each mode.

[SERIAL NUMBER]

[PROJECTOR]	Displays the serial number of the projector.
-------------	--

Note

- To estimate the lamp replacement timing, check the lamp usage time (converted value) displayed in [LAMP RUNTIME] (➡ page 66) of [PROJECTOR SETUP].
- The actual total usage time of [ECO] and [NORMAL] may be shorter than the lamp usage time (converted value).

[PROJECTOR ID]

The projector has an ID number setting function, and simultaneous control or individual control is possible with one remote control when multiple projectors are used side by side.

- 1) Press ▲▼ to select [PROJECTOR ID].
- 2) Press the <ENTER> button.
 - The [PROJECTOR ID] screen is displayed.
- 3) Press ▲▼ to select [PROJECTOR ID].
 - Select one from [ALL], and [1] to [6].
- 4) Press the <ENTER> button to set it.
 - [PROJECTOR ID] is set.

Note

- The ID number of the remote control needs to be matched with the ID number of the projector when the ID number is specified and individually controlled.
- When the ID number is set to [ALL], the projector will operate regardless of what ID number is specified from the remote control or the computer. If multiple projectors are used and some of them have their IDs set to [ALL], they cannot be controlled separately from the projectors with other ID numbers.
- Refer to “Setting Remote control ID numbers” (➡ page 22) regarding the method to set the ID number on the remote control.

[PROJECTOR SETUP] menu

[INITIAL START UP]

Set the mode for start-up when the <MAIN POWER> switch is turned <ON>.

- 1) Press ▲▼ to select [INITIAL START UP].
- 2) Press ◀▶ to switch [INITIAL START UP].
 - The setting will change as follows each time you press the button.



[LAST MEMORY]	Starts up the projector in the mode it was in before the <MAIN POWER> switch is turned to <OFF>.
[STANDBY]	Starts up in the standby mode.
[ON]	Starts projection immediately.

[PROJECTION METHOD]

You can set the projection method in accordance with the installation status of the projector. Change the projection method if the screen display is upside down or inverted.

- 1) Press ▲▼ to select [PROJECTION METHOD].
- 2) Press ◀▶ to switch [PROJECTION METHOD].
 - The setting will change as follows each time you press the button.

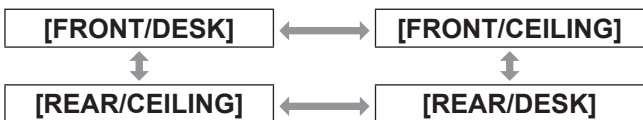

[FRONT/DESK]	When installing on the desk, etc., in front of the screen
[FRONT/CEILING]	When installing using the ceiling mount bracket (optional) in front of the screen
[REAR/DESK]	When installing on the desk, etc., behind the screen (using a translucent screen)
[REAR/CEILING]	When installing using the ceiling mount bracket (optional) behind the screen (using a translucent screen)

[HIGH ALTITUDE MODE]

If you use the projector at high elevations (1 400 m (4 593 ft) or higher and lower than 2 700 m (8 858 ft)), [ON] must be set.

- 1) Press ▲▼ to select [HIGH ALTITUDE MODE].
- 2) Press ◀▶ to switch [HIGH ALTITUDE MODE].
 - The setting will change as follows each time you press the button.



[OFF]	When using at a place lower than 1 400 m (4 593 ft) above sea level
[ON]	When using at elevations (1 400 m (4 593 ft) or higher and lower than 2 700 m (8 858 ft) above sea level)

Note

- Make sure to set this to [OFF] when you use the projector at elevations lower than 1 400 m (4 593 ft) above sea level, and set this to [ON] when you use the projector at elevations of 1 400 m (4 593 ft) or higher and lower than 2 700 m (8 858 ft). Failure to do so may shorten the life of the internal parts and result in malfunctions.
- Do not install the projector at elevations of 2 700 m (8 858 ft) or higher above sea level. Failure to do so may shorten the life of the internal parts and result in malfunctions.
- The speed of the fan is raised and the operation sound will become louder when this is set to [ON].

[PROJECTOR SETUP] menu

[LAMP POWER]

You can switch the electric power of projector lamp. Set the lamp power to meet the environment and purpose of projection.

- 1) Press ▲▼ to select [LAMP POWER].
- 2) Press ◀▶ to switch [LAMP POWER].
 - The setting will change as follows each time you press the button.



[NORMAL]	When high brightness is needed
[ECO]	When high brightness is not needed

Note

- The [ECO] mode can reduce power consumption and operation noise.
- The selection made here is reflected to the indication of the “ECO setting level” in the “Multi Projector Monitoring & Control Software” installed from the supplied CD-ROM.

[LAMP RUNTIME]

You can display the lamp usage time (converted value).

Attention

- When replacing the lamp, follow the “Replacing the lamp unit” (➔ page 102) and reset the lamp usage time (converted value) to 0.

Note

- When the lamp unit has reached the end of its life, the lamp usage time (converted value) is indicated in red and gray. Refer to “When to replace the lamp unit” (➔ page 101) for details about the lifespan.

[SCHEDULE]

You can set the command execution schedule for each day of the week.

- 1) Press ▲▼ to select [SCHEDULE].
- 2) Press ◀▶ to switch [SCHEDULE].
 - The setting will change as follows each time you press the button.



[OFF]	Disables the set schedule.
[ON]	Enables the set schedule.

Note

- If [SCHEDULE] is set to [ON], the setting for [STANDBY MODE] (➔ page 68) in [ECO MANAGEMENT] is automatically set to [NORMAL] and cannot be changed. Even if [SCHEDULE] is then set to [OFF] when in this state, the setting of [STANDBY MODE] remains at [NORMAL].

■ How to assign a program

- 3) Select [ON] in Step 2), and press the <ENTER> button.
 - The [SCHEDULE] screen is displayed.
- 4) Select and assign program to each day of week.
 - Press ▲▼ to select the day of week, and press ◀▶ to select a program number.
 - You can set the program from No.1 to No.7. “- -” indicates that the program number has not been set yet.

■ How to set a program

You can set up to 16 commands to each program.

- 3) Select [ON] in Step 2), and press the <ENTER> button.
- 4) Press ▲▼ to select [PROGRAM EDIT].
- 5) Press ◀▶ to select a program number to be set ([PROGRAM 1] to [PROGRAM 7]) and press the <ENTER> button.
- 6) Press ▲▼ to select a command number (01 to 16), and press the <ENTER> button.
 - You can change the page using ▲▼.

7) Press ▲▼ to select [TIME] or [COMMAND], and change the settings according to the operation instructions of the menu.

[TIME]	Sets the time at which the command will be executed using ▲▼ .	
[COMMAND]	Selects a command to execute at the set time from the following.	
	[POWER ON]	
	[STANDBY]	
	[AV MUTE]	[ON] [OFF]
	[INPUT]	[COMPUTER] [VIDEO] [S-VIDEO] [COMPONENT] [HDMI 1] [HDMI 2]
	[LAMP POWER]	[NORMAL] [ECO]
	[IN STANDBY MODE]	[ON] [OFF]
[VOLUME]		

8) Press ▲▼ to select [STORE], and press the <ENTER> button.

Note

- If you try to register a setting that would cause the lamp to flash for a short time, an error message will be displayed on the screen and the setting will not be registered. Set the time and command again.
- If multiple commands have been set for the same time, they are executed in chronological order starting from the smallest command number.
- The operating time will be the local time. (➡ page 71)
- If an operation is executed with the remote control or control panel of the projector or with a control command before the command set in [SCHEDULE] is executed, the command set with this function may not be executed.

[ECO MANAGEMENT]

You can optimize lamp power and reduce the power consumption according to the application.

- 1) Press ▲▼ to select [ECO MANAGEMENT].
- 2) Press the <ENTER> button.
 - The [ECO MANAGEMENT] screen is displayed.
- 3) Press ▲▼ to select an item.

■ When [AUTO POWER SAVE] was set in Step 3)

You can enable [AMBIENT LIGHT DETECTION], [SIGNAL DETECTION], and [AV MUTE DETECTION] functions.

Note

- This setting is not available if [LAMP POWER] (➡ page 66) is set to [ECO].
- 4) Press ◀▶ to switch [AUTO POWER SAVE].
 - The setting will change as follows each time you press the button.



[ON]	Enables the auto power save function.
[OFF]	Disables the auto power save function.

- 5) Press ▲▼ to select [AMBIENT LIGHT DETECTION], [SIGNAL DETECTION], or [AV MUTE DETECTION].

[AMBIENT LIGHT DETECTION]	Adjusts the lamp power according to the ambient brightness.
[SIGNAL DETECTION]	Drops the lamp power when no signal is input.
[AV MUTE DETECTION]	Drops the lamp power in the AV Mute mode.

- 6) Press ◀▶ to switch the setting.
 - The setting will change as follows each time you press the button.



[ON]	Enables the setting.
[OFF]	Disables the setting.

[PROJECTOR SETUP] menu

Note

- In the following cases, lamp power may not drop automatically.
 - When [LAMP POWER] is set to [ECO]
 - Immediately after the lamp is turned on or immediately after setting [LAMP POWER]
- If [AUTO POWER SAVE] is [OFF], [AMBIENT LIGHT DETECTION], [SIGNAL DETECTION], and [AV MUTE DETECTION] cannot be set.
- The selection made here is reflected to the indication of the “ECO setting level” in the “Multi Projector Monitoring & Control Software” installed from the supplied CD-ROM.

■ When [NO SIGNAL SHUT-OFF] was set in Step 3)

The projector enters the standby mode automatically if no signal input status maintains. You can set the latency until the projector enters the standby mode.

4) Press ◀ ▶ to switch [NO SIGNAL SHUT-OFF].

- The setting will change as follows each time you press the button.



[DISABLE]	Disables the no signal shut-off function.
[15MIN.] to [60MIN.]	Enables the no signal shut-off function. Allows you to set a time in five minute increments.

Note

- The selection made here is reflected to the indication of the “ECO setting level” in the “Multi Projector Monitoring & Control Software” installed from the supplied CD-ROM.
- The duration is set to [30MIN.] by default and after you perform initialization.

■ When [STANDBY MODE] was set in Step 3)

You can set the power consumption during the standby.

4) Press ◀ ▶ to switch [STANDBY MODE].

- The setting will change as follows each time you press the button.



[ECO]	Restricts some functions in the standby mode to reduce power consumption.
[NORMAL]	Does not restrict functionality even in the standby mode.

Note

- If [SCHEDULE] is set to [ON], the setting for [STANDBY MODE] in [ECO MANAGEMENT] is automatically set to [NORMAL] and cannot be changed. Even if [SCHEDULE] is then set to [OFF] when in this state, the setting of [STANDBY MODE] remains at [NORMAL].
- If set to [ECO], you cannot use network functions when the projector is standing by. Also, you cannot use some protocol commands from <SERIAL> terminals. When you turn on the power, projection of the initial image may be delayed when compared with [NORMAL] mode operation.
- If set to [NORMAL], you can use network functions when the projector is standing by.

[EMULATE]

When using the control commands for one of our projectors that you have previously purchased to control this projector using a computer via its <SERIAL> input terminal, set up the function as follows. This will allow you to use the control software etc. designed for our existing projectors.

- 1) Press ▲▼ to select [EMULATE].
- 2) Press the <ENTER> button.
 - The [EMULATE] individual adjustment screen is displayed.
- 3) Press ▲▼ to select an item.

[DEFAULT]	LZ370 series
[D3500]	D3500 series
[D4000]	D4000 series
[D/W5k series]	DX800 series, DW730 series, D5700 series, DW5100 series, D5600 series, DW5000 series, D5500 series
[D/W/Z6k series]	DZ6710 series, DZ6700 series, DW6300 series, D6000 series, D5000 series, DZ570 series, DW530 series, DX500 series
[L730]	L730 series, L720 series, L520 series
[L780]	L780 series, L750 series
[L735]	L735 series
[L785]	L785 series
[LB/W series]	LB3 series, LB2 series, LB1 series, ST10 series, LB90 series, LW80NT series, LB80 series, LB75 series
[F/W series]	FW430 series, FX400 series, FW300 series, F300 series, F200 series, FW100 series, F100 series

- 4) Press the <ENTER> button.

Note

- Refer to “<SERIAL> terminal” (➡ page 111).

[FUNCTION BUTTON]

The functions assigned to the <FUNC1> to <FUNC3> buttons are displayed. You can also release the assignment settings.

■ To cancel assigned functions to the <FUNC1> to <FUNC3> buttons

- 1) Press ▲▼ to select [FUNCTION BUTTON].
- 2) Press the <ENTER> button.
- 3) Press ▲▼ to select [DISABLE] for a function button (F1 to F3) you want to release the assignment.
- 4) Press the <ENTER> button.
- 5) When the confirmation message is displayed, select [OK] and press the <ENTER> button.

[PROJECTOR SETUP] menu

[AUDIO SETTING]

Displays the details of the audio functions.

- 1) Press ▲▼ to select [AUDIO SETTING].
- 2) Press the <ENTER> button.
 - The [AUDIO SETTING] screen is displayed.
- 3) Press ▲▼ to select an item, and press ◀▶ to adjust levels or change settings.

■ [VOLUME]

Adjusts the volume of the speaker.

Operation	Adjustment	Range
Press ▶ .	Increases the volume.	Maximum value 63
Press ◀ .	Decreases the volume.	Minimum value 0

■ [BALANCE]

You can adjust the balance of left/right audio output.

Operation	Adjustment	Range
Press ▶ .	Increases the volume from the right.	L16 to R16
Press ◀ .	Increases the volume from the left.	

■ [IN STANDBY MODE]

You can set the audio output during the standby.

- The setting will change as follows each time you press the button.

[OFF]	Disables audio output during the standby.
[ON]	Enables audio output during the standby.

Note

- You cannot enable sound output during standby if [STANDBY MODE] (➔ page 68) of [ECO MANAGEMENT] is set [ECO].

■ [AUDIO IN SELECT]

You can select the audio input from connected external equipment.

- The setting will change as follows each time you press the button.

● To set [HDMI 1]



[HDMI 1 AUDIO IN]	Outputs HDMI 1 audio when the HDMI 1 input is selected.
[AUDIO IN]	Outputs audio from the device connected to the <AUDIO IN> terminal when the HDMI 1 input is selected.

● To set [HDMI 2]



[HDMI 2 AUDIO IN]	Outputs HDMI 2 audio when the HDMI 2 input is selected.
[AUDIO IN]	Outputs audio from the device connected to the <AUDIO IN> terminal when the HDMI 2 input is selected.

Note

- Sound is output from the device connected to the <AUDIO IN> terminal when you have set an input selection item other than [HDMI 1] or [HDMI 2].

[DATE AND TIME]

You can set the time zone, date, and time of the built-in clock of the projector.

By default, the time is set to +09:00.

■ To set the time zone

- 1) Press ▲▼ to select [DATE AND TIME].
- 2) Press the <ENTER> button.
 - The [DATE AND TIME] screen is displayed.
- 3) Press ▲▼ to select [TIME ZONE].
- 4) Press ◀▶ to switch [TIME ZONE].

■ To adjust the date and time automatically

- 1) Press ▲▼ to select [DATE AND TIME].
- 2) Press the <ENTER> button.
 - The [DATE AND TIME] screen is displayed.
- 3) Press ▲▼ to select [ADJUST CLOCK].
- 4) Press the <ENTER> button.
 - The [ADJUST CLOCK] screen is displayed.
- 5) Press ▲▼ to select [NTP SYNCHRONIZATION], and press ◀▶ to change the setting to [ON].
 - The setting will change as follows each time you press the button.



[OFF]	Does not synchronize NTP server.
[ON]	Synchronizes NTP server.

- 6) Press ▲▼ to select [OK], and press the <ENTER> button.
 - The setting of the date and time will be completed.

■ To adjust the date and time manually

- 1) Press ▲▼ to select [DATE AND TIME].
- 2) Press the <ENTER> button.
 - The [DATE AND TIME] screen is displayed.
- 3) Select [ADJUST CLOCK].
- 4) Press the <ENTER> button.
 - The [ADJUST CLOCK] screen is displayed.
- 5) Press ▲▼ to select [NTP SYNCHRONIZATION], and press ◀▶ to change the setting to [OFF].
- 6) Press ▲▼ to select the item to be set, and press ◀▶ to set the local date and time.
- 7) Press ▲▼ to select [OK], and press the <ENTER> button.
 - The setting of the date and time will be completed.

Note

- To set the date and time automatically, the projector must be connected to the network.
- If synchronization with the NTP server fails just after [NTP SYNCHRONIZATION] is turned [ON], or if [NTP SYNCHRONIZATION] is turned [ON] while the NTP server is not set, [NTP SYNCHRONIZATION] will return to [OFF].
- Access the projector via a web browser to set the NTP server. Refer to "[Adjust clock] page" (➔ page 85) for details.

[PROJECTOR SETUP] menu

[TEST PATTERN]

Displays the test pattern built-in to the projector. Settings of position, size, and other factors will not be reflected in test patterns. Make sure to display the input signal before performing various adjustments.

- 1) Press **▲▼** to select **[TEST PATTERN]**.
- 2) Press the **<ENTER>** button.
 - The test pattern is displayed.
- 3) Press **◀▶** to switch the various test patterns.
 - Press the **<MENU>** button or the **<RETURN>** button to return to the sub-menu of **[PROJECTOR SETUP]**.

■ To display sequence of internal test patterns

The setting will change as follows each time you press **◀▶**.

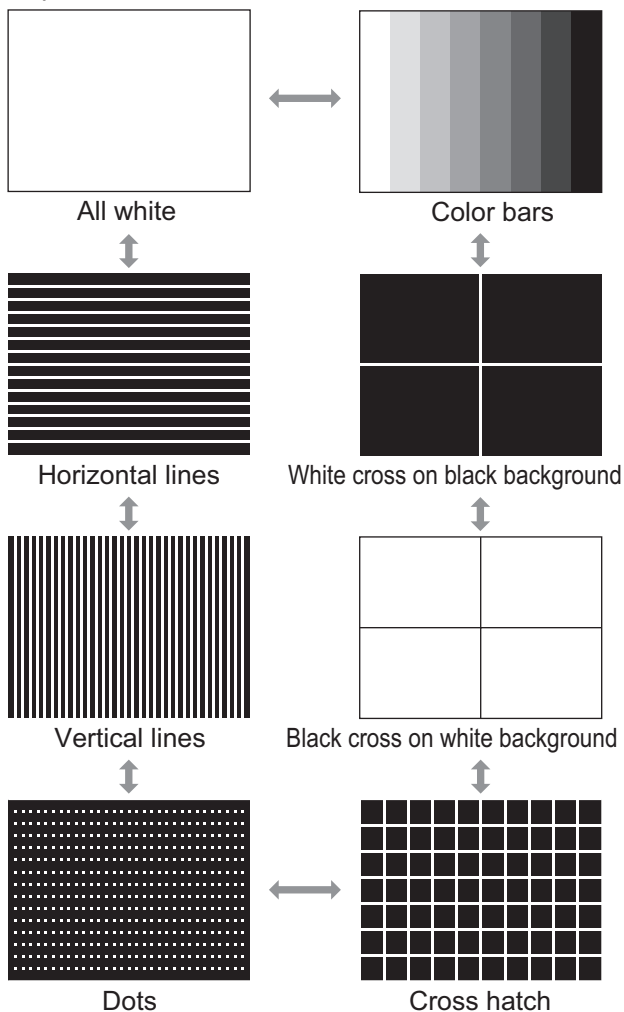

Note

- The default screen is all white. If you assign this to the **<FUNC1>** to **<FUNC3>** buttons, Cross hatch becomes the default.

[INITIALIZE ALL]

You can return various setting values to the factory default settings.

When you perform this function, the projector enters standby mode to initialize.

- 1) Press **▲▼** to select **[INITIALIZE ALL]**.
- 2) Press the **<ENTER>** button.
 - **[INITIALIZE ALL]** is displayed.
 - Password entry is required if you have set **[ON]** in the **[SECURITY]** menu → **[PASSWORD]** (➔ page 73).
- 3) Press **◀▶** to select **[OK]**.
- 4) Press the **<ENTER>** button.
 - The **[NOW INITIALIZING...]** screen appears, and is followed by **[POWER OFF.]**.
- 5) Press the **<ENTER>** button.
 - Key operations other than the **<ENTER>** button and the power **<⏻/|>** button are unavailable at this time.
- 6) Wait until the power indicator **<ON (G)/STANDBY (R)>** of the projector illuminates or flashes red (the fan stops).
- 7) Press the **<OFF>** side of the **<MAIN POWER>** switch to turn off the power.
 - The initial setting screen appears the next time the projector is started. (➔ page 18)

Note

- The projector usage time, lamp usage time, and **[NETWORK]** settings are not initialized.
- After performing initialization, the password is returned to its factory default and **[PASSWORD]** is set to **[OFF]**.

[SECURITY] menu

Select [SECURITY] from the main menu, and select the item from the sub-menu. Refer to “Navigating through the menu” (➔ page 42) for the operation of the menu screen.

- When the projector is used for the first time
Initial password: Press ▲▶▼◀▲▶▼◀ in order, and press the <ENTER> button.
- After selecting the item, press ▲▼◀▶ to set.

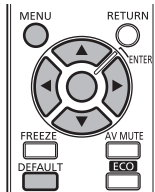

Attention

- Make the settings after displaying the [SECURITY] screen.
- When the [SECURITY] screen is displayed, entering a password is required. Enter the set password and then continue operations.
- When the password has been changed previously, enter the changed password, and press the <ENTER> button.

Note

- The entered password is displayed with * mark on the screen.

[PASSWORD]

You can set to display the security password entry screen when the projection starts. If the correct password is not entered, any operation other than the power <⏻/|> button operations becomes unavailable.

- 1) Press ▲▼ to select [PASSWORD].
- 2) Press ◀▶ to switch [PASSWORD].
 - The setting will change as follows each time you press the button.



[OFF]	Disables the security password entry.
[ON]	Enables the security password entry.

Note

- The [PASSWORD] is set to [OFF] by default and after you perform initialization.
- Change the password periodically that is hard to guess.
- The security password will be enabled after setting [PASSWORD] to [ON] and turning off the power (standby mode).

[PASSWORD CHANGE]

You can change the security password.

- 1) Press ▲▼ to select [PASSWORD CHANGE].
- 2) Press the <ENTER> button.
 - The [PASSWORD CHANGE] screen is displayed.
- 3) Press ▲▼◀▶ and number (<1> - <6>) buttons to set the password.
 - Up to eight button operations can be set.
- 4) Press the <ENTER> button.
- 5) Re-enter the password for the confirmation.
- 6) Press the <ENTER> button.

Note

- The entered password is displayed with * mark on the screen.
- An error message is displayed on the screen when the entered password is incorrect. Re-enter the correct password.
- When numerals are used in the security password, initialization of the security password will be necessary if the remote control is lost. For the method of initialization, consult your dealer.

[SECURITY] menu

[DISPLAY SETTING]

You can overlap the security message (text or image) over the projecting image.

- 1) Press ▲▼ to select [DISPLAY SETTING].
- 2) Press ◀▶ to switch [DISPLAY SETTING].
 - The setting will change as follows each time you press the button.



[OFF]	Disables the text/user logo display.
[TEXT]	Enables the text display.
[USER LOGO]	Projects the logo transferred with "Logo Transfer Software"*1.

*1: "Logo Transfer Software" is included in the attached CD-ROM.

Note

- To create the image for [USER LOGO], "Logo Transfer Software" included in the supplied CD-ROM is required.
- You cannot display both security message and closed caption at the same time.

[TEXT CHANGE]

You can change the text displayed when the text display is enabled by selecting [TEXT] in [DISPLAY SETTING].

- 1) Press ▲▼ to select [TEXT CHANGE].
- 2) Press the <ENTER> button.
 - The [TEXT CHANGE] screen is displayed.
- 3) Press ▲▼◀▶ to select the text, and press the <ENTER> button to enter the text.
 - Up to 22 characters can be entered.
- 4) Press ▲▼◀▶ to select [OK], and press the <ENTER> button.
 - The text is changed.

[MENU LOCK]

You can set whether to display the menu and perform the menu operation when you press the <MENU> button.

- 1) Press ▲▼ to select [MENU LOCK].
- 2) Press ◀▶ to switch [MENU LOCK].
 - The setting will change as follows each time you press the button.

[OFF]	↔	[ON]
[OFF]	Disables the lock of the menu operation.	
[ON]	Locks the menu operation.	

Note

- If an incorrect menu lock password is entered after [MENU LOCK] is set to [ON], the menu operation is disabled.
- The [MENU LOCK] is set to [OFF] by default and after you perform initialization.
- The unlock status is maintained until the projector is set to the standby mode.

[MENU LOCK PASSWORD]

You can change the MENU LOCK PASSWORD.

- 1) Press ▲▼ to select [MENU LOCK PASSWORD].
- 2) Press the <ENTER> button.
 - The [MENU LOCK PASSWORD] screen is displayed.
- 3) Press ▲▼◀▶ to select the text, and press the <ENTER> button to enter the text.
 - Up to 16 characters can be entered.
- 4) Press ▲▼◀▶ to select [OK], and press the <ENTER> button.
 - Select [CANCEL] to stop.

Attention

- The initial password when used for the first time or after initializing is “AAAA”.
- Change the password periodically that is hard to guess.

[CONTROL DEVICE SETUP]

You can enable/disable the button operations on the control panel and the remote control.

- 1) Press ▲▼ to select [CONTROL DEVICE SETUP].
- 2) Press the <ENTER> button.
 - The [CONTROL DEVICE SETUP] screen is displayed.
- 3) Press ▲▼ to select an item, and press ◀▶ to change the setting.
 - When the confirmation message is displayed after setting [DISABLE], select [OK] and press the <ENTER> button.

■ [CONTROL PANEL]

- You can set the limitation on the control from the control panel.

[ENABLE]	Enables the button operation from the main unit.
[DISABLE]	Disables the button operation from the main unit.

■ [REMOTE CONTROLLER]

- You can set the limitation on the control from the remote control.

[ENABLE]	Enables the button operation from the remote control.
[DISABLE]	Disables the button operation from the remote control.

Note

- It will not be possible to turn off the power (standby status) if the operations of both of [CONTROL PANEL] and [REMOTE CONTROLLER] are set to [DISABLE].

Canceling [DISABLE] setting:

Press the <ENTER> button while holding down the <MENU> button for at least two seconds on the main unit controls to reset the [DISABLE] setting on [CONTROL PANEL] to [ENABLE]. Use the control panel of the projector to change the setting of [REMOTE CONTROLLER].

[NETWORK] menu

Select [NETWORK] from the main menu, and select the item from the sub-menu. Refer to “Navigating through the menu” (➔ page 42) for the operation of the menu screen.

- After selecting the item, press ▲▼◀▶ to set.

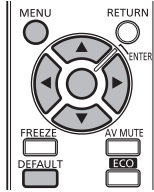

[WIRED LAN]

Perform the initial setting of the network before using the network function.

- 1) Press ▲▼ to select [WIRED LAN].
- 2) Press the <ENTER> button.
 - The [WIRED DETAILED SETUP] screen is displayed.
- 3) Press ▲▼ to select an item, and change the settings according to the operation instructions of the menu.

[DHCP]	Set the item to [ON] when using a DHCP server to automatically acquire the IP address. Set to [OFF] when not using a DHCP server.
[IP ADDRESS]	Enter the IP address when not using a DHCP server.
[SUBNET MASK]	Enter the subnet mask when not using a DHCP server.
[DEFAULT GATEWAY]	Enter the default gateway address when not using a DHCP server.

- 4) Press ▲▼◀▶ to select [OK], and press the <ENTER> button.
 - Save the current network settings.

Note

- When using a DHCP server, confirm that the DHCP server is running.
- Consult your network administrator regarding the IP address, subnet mask, and default gateway.
- The following settings are applied by default.

[DHCP]	[OFF]
[IP ADDRESS]	192.168.10.100
[SUBNET MASK]	255.255.255.0
[DEFAULT GATEWAY]	192.168.10.1

[NAME CHANGE]

You can change the name of the projector displayed on the network.

- 1) Press ▲▼ to select [NAME CHANGE].
- 2) Press the <ENTER> button.
 - The [NAME CHANGE] screen is displayed.
- 3) Press ▲▼◀▶ to select the text, and press the <ENTER> button to enter the text.
 - Select [ALL DELETE] to delete all the entered characters, or press the <DEFAULT> button on the remote control to delete a character on the cursor in the entry field.
- 4) After entering the name, press ▲▼◀▶ to select [OK], and press the <ENTER> button.
 - To cancel the change of the name, select [CANCEL] and press the <ENTER> button.

Note

- The projector name is set to Name0000 by default.

[NETWORK CONTROL]

You can set this function to control the projector from a computer connected via the network.

- 1) Press ▲▼ to select [NETWORK CONTROL].
- 2) Press ◀▶ to switch [NETWORK CONTROL].
 - Each time you press the button, the settings change as follows.



[ON]	Enables the control function from a computer connected via the network.
[OFF]	Disables the control function from a computer connected via the network.

[STATUS]

You can display the network status of the projector.

- 1) Press ▲▼ to select [STATUS].
- 2) Press the <ENTER> button.
 - The [STATUS] screen is displayed.

[INITIALIZE]

You can restore the network settings to the factory default settings.

- 1) Press ▲▼ to select [INITIALIZE].
- 2) Press the <ENTER> button.
 - [INITIALIZE] is displayed.

Note

- The security password entry is required if you have set [ON] in the [SECURITY] menu → [PASSWORD] (➔ page 73).
- 3) Press ◀▶ to select [OK], and press the <ENTER> button.

[NETWORK] menu

Network connections

The projector has a network function, and the following operations are available from the computer using the Web browser control.

- Setting and adjustment of the projector
- Display of the projector status
- Setting of E-mail notification

“Crestron RoomView” is a system developed by Crestron Electronics, Inc. which collectively manage and control multiple system devices connected via the network, from a computer. This projector supports “Crestron RoomView”.

- For details of “Crestron RoomView”, refer to the Crestron Electronics, Inc. website. (Provided only in English.)
URL <http://www.crestron.com>
For the download of “Crestron RoomView Express”, refer to the Crestron Electronics, Inc. website. (Provided only in English.)
URL <http://www.crestron.com/getroomview>

Note

- A LAN cable is required to use the network function.
- The information and the URL of the website may be changed or deleted without notice.

- A Web browser is required to use this function. Confirm that the Web browser can be used beforehand.
Compatible OS: Windows XP/Windows Vista/Windows 7, Mac OS X v10.4/v10.5/v10.6/v10.7
Compatible browser: Internet Explorer 7.0/8.0/9.0, Safari 4.0/5.0 or later (Mac OS)
- Communication with an E-mail server is required to use the E-mail function. Confirm that the E-mail can be used beforehand.
- Use a LAN cable that is straight-through or crossover*¹ and compatible with category 5 or higher.
*1: Depending on the system configuration, the type of the LAN cable that can be used may be either straight-through, crossover, or both. Consult your network administrator for the details.
- Use a LAN cable with the length of 100 m (328'1") or shorter.

Required environment for computer connection

- Check if your computer is equipped with wired LAN beforehand.
- Before connecting the projector to your computer, be sure to check the following settings.

■ Check 1: LAN cable

- Is the cable connected correctly?
- Use a LAN cable compatible with category 5 or higher.

■ Check 2: Wired LAN settings

A computer equipped with wired LAN function

- Is the wired LAN function activated?

A computer not equipped with wired LAN function

- Is the wired LAN adapter recognized correctly?
- Is the wired LAN adapter activated?
- Install the wired LAN adapter driver before you use the network function.
Refer to the instruction manual of the wired LAN adapter for the installation of the driver.

Network settings of computer

Configure the network settings (wired LAN) of the computer.

- 1) Turn on the power of your computer.
- 2) Follow the network administrator's instructions to configure the network settings.
 - If the projector is in the default settings (➔ page 76), make the following network settings on your computer.

IP address	192.168.10.100
Subnet mask	255.255.255.0
Default gateway	192.168.10.1

Accessing from the Web browser

- 1) Start up the Web browser on the computer.
- 2) Enter the IP address set on the projector into the URL entry field of the Web browser.
- 3) Enter the user name and the password.
 - The factory default setting of the user name is user1 (user rights)/admin1 (administrator rights) and the password is panasonic (lower case).

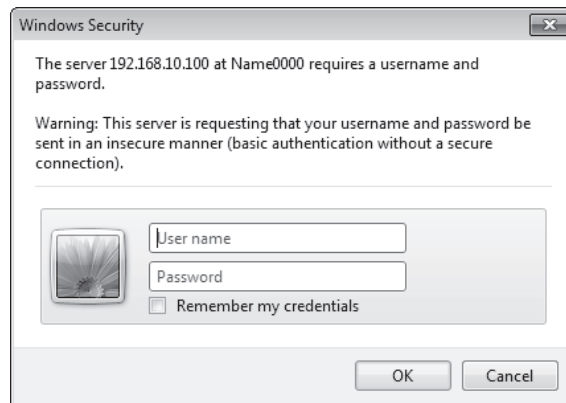

- 4) Click OK.
 - The [Projector status] page is displayed.

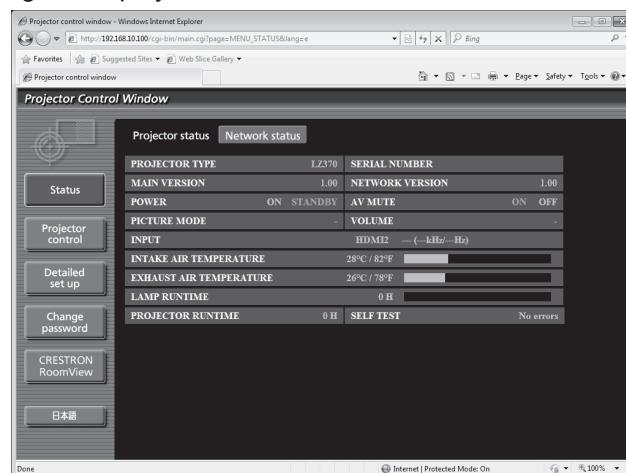

[NETWORK] menu

Note

- If you control the projector using a Web browser, set [NETWORK CONTROL] (➡ page 77) to [ON].
- Do not perform setting or control simultaneously by starting up multiple Web browsers. Do not set or control the projector from multiple computers.
- Change the password first. (➡ page 91)
- The administrator rights allows to use all functions. The user rights allows to display only the following buttons on the screen and use those functions: [Projector status] (➡ page 81), [Network status] (➡ page 83), [Basic control] (➡ page 83), [Advanced control] (➡ page 84), and [Change password] (➡ page 91).
- Access will be locked for few minutes when an incorrect password is entered three times consecutively.

Descriptions of items

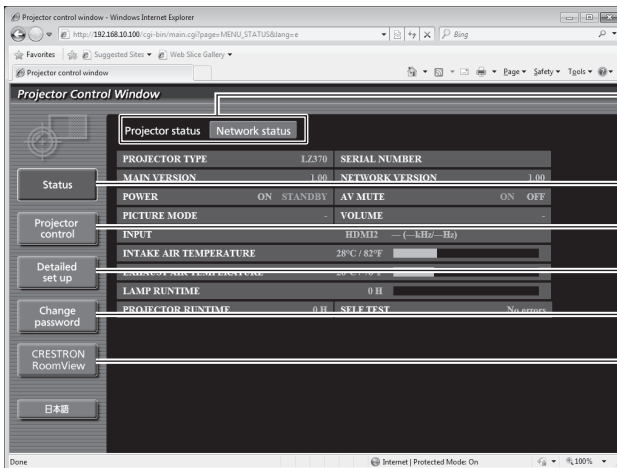

- (1) **Page tab**
Switches pages by clicking it.
- (2) **[Status]**
The status of the projector is displayed by clicking this item.
- (3) **[Projector control]**
The [Projector control] page is displayed by clicking this item.
- (4) **[Detailed set up]**
The [Detailed set up] page is displayed by clicking this item.
- (5) **[Change password]**
The [Change password] page is displayed by clicking this item.
- (6) **[CRESTRON RoomView]**
The RoomView operation page is displayed by clicking this item.

■ [Projector status] page

Click [Status] → [Projector status].

Displays the status of the projector for the following items.

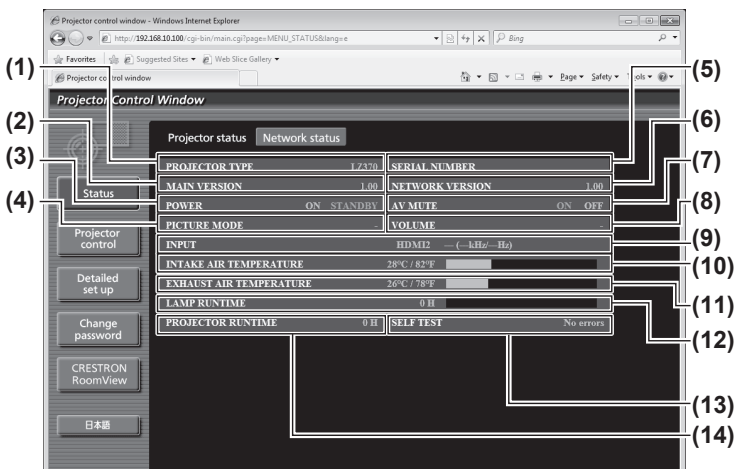

- (1) **[PROJECTOR TYPE]**
Displays the type of the projector.
- (2) **[MAIN VERSION]**
Displays the firmware version of the projector.
- (3) **[POWER]**
Displays the power status.
- (4) **[PICTURE MODE]**
Displays the status of the picture mode.
- (5) **[SERIAL NUMBER]**
Displays the serial number of the projector.
- (6) **[NETWORK VERSION]**
Displays the firmware version of the network.
- (7) **[AV MUTE]**
Displays the status of the AV mute.
- (8) **[VOLUME]**
Displays the status of the volume.
- (9) **[INPUT]**
Displays the selected video input.
- (10) **[INTAKE AIR TEMPERATURE]**
Displays the status of the intake air temperature of the projector.
- (11) **[EXHAUST AIR TEMPERATURE]**
Displays the status of the exhaust air temperature of the projector.
- (12) **[LAMP RUNTIME]**
Displays the lamp usage time (converted value).
- (13) **[SELF TEST]**
Displays the self-diagnosis information.
- (14) **[PROJECTOR RUNTIME]**
Displays the operation times of the projector.

[NETWORK] menu

■ Error information page

When [Error (Detail)] is displayed on the [Projector status] screen, click it to display the error details.

- The projector may go into the standby status to protect the projector depending on the contents of the error.

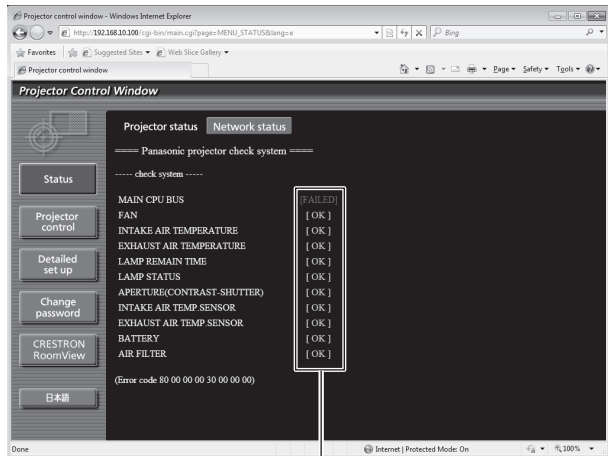
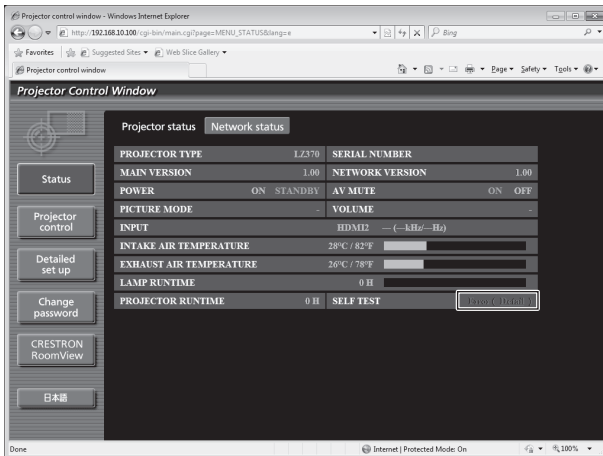

[OK]: Normal operation
 [FAILED]: Occurrence of trouble
 [WARNING]: Warning

● Description of problem occurrence [FAILED]:

Item	Description
[MAIN CPU BUS]	There is a problem with the microcomputer circuitry. Consult your dealer.
[FAN]	There is a problem with the fan or the fan drive circuit. Consult your dealer.
[INTAKE AIR TEMPERATURE]	The intake air temperature is too high. It may be used in an operating environment where the temperature is high, such as near a heating appliance, the intake port may be blocked, or the air filter may be clogged.
[EXHAUST AIR TEMPERATURE]	The exhaust air temperature is too high. The air exhaust port may be blocked, or the mode setting for using the projector at high elevations may be wrong.
[LAMP REMAIN TIME]	The lamp usage time has exceeded the specified time, and it is time to replace the lamp.
[LAMP STATUS]	The lamp has failed to turn on. Wait a while until the luminous lamp cools off, and then turn on the power.
[APERTURE(CONTRAST-SHUTTER)]	There is a problem with the contrast shutter circuitry. Consult your dealer.
[INTAKE AIR TEMP.SENSOR]	There is a problem with the sensor used to detect intake air temperature. Consult your dealer.
[EXHAUST AIR TEMP.SENSOR]	There is a problem with the sensor used to detect exhaust air temperature. Consult your dealer.
[BATTERY]	The battery replacement is required. Consult your dealer.
[AIR FILTER]	There is too much dust accumulated in the air filter unit. Turn the <MAIN POWER> switch to <OFF> (➡ page 36), and clean the air filter (➡ page 97).

■ [Network status] page

Click [Status] → [Network status].
The current network setting status is displayed.

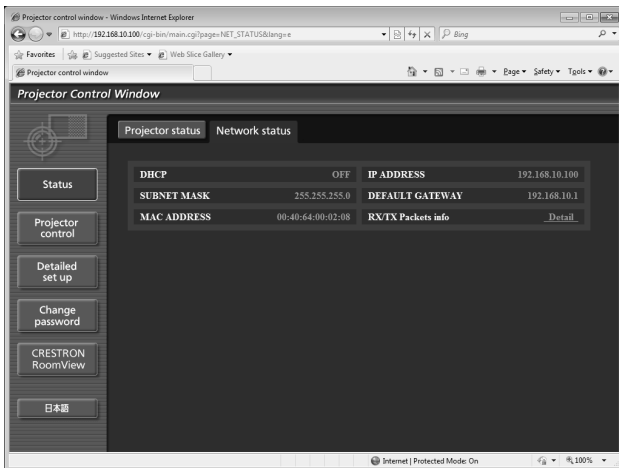

■ [Basic control] page

Click [Projector control] → [Basic control].

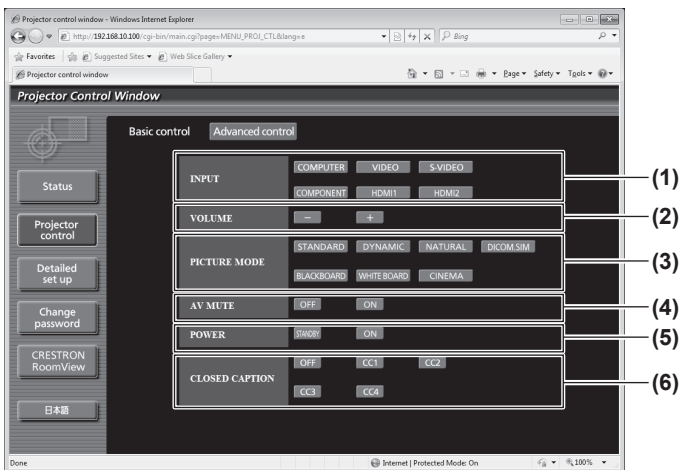

- (1) **[INPUT]**
Switches the input mode.
- (2) **[VOLUME]**
Adjusts the volume
- (3) **[PICTURE MODE]**
Switches the picture mode.
- (4) **[AV MUTE]**
Switches between on and off of the AV mute.
- (5) **[POWER]**
Switches between off and on of the power.
- (6) **[CLOSED CAPTION]**
Switches the setting for the closed caption.

[NETWORK] menu

[Advanced control] page

Click [Projector control] → [Advanced control].

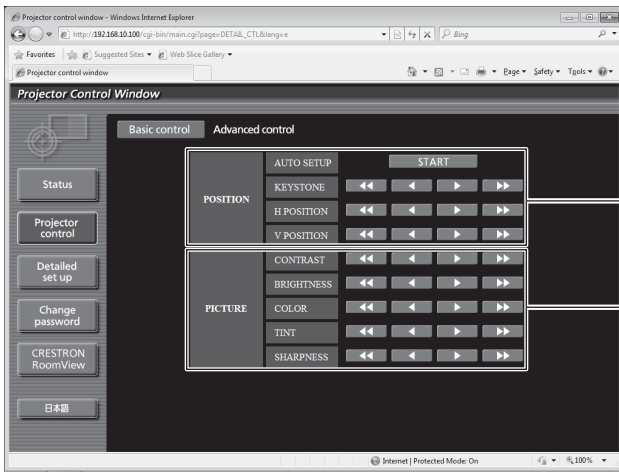

- (1) **[POSITION]**
Operates items regarding angle of view.
- (2) **[PICTURE]**
Operates items regarding picture quality.

[Network config] page

Click [Detailed set up] → [Network config].

- The [CAUTION!] screen is displayed by clicking [Network config].
- The current settings are displayed by clicking the [Next] button.
- The following setting change screen is displayed by clicking the [Change] button.

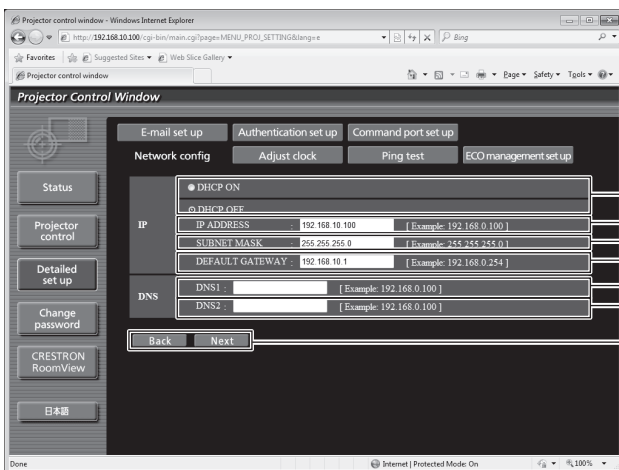

- (1) **[DHCP ON]/[DHCP OFF]**
To enable the DHCP client function, set to [DHCP ON].
- (2) **[IP ADDRESS]**
Enter the IP address when not using a DHCP server.
- (3) **[SUBNET MASK]**
Enter the subnet mask when not using a DHCP server.
- (4) **[DEFAULT GATEWAY]**
Enter the gateway address when not using a DHCP server.
- (5) **[DNS1]**
Allowed characters for the entry of DNS 1 server address (primary):
Numbers (0 to 9), period (.)
(Example: 192.168.0.253)
- (6) **[DNS2]**
Allowed characters for the entry of DNS 2 server address (secondary):
Numbers (0 to 9), period (.)
(Example: 192.168.0.254)
- (7) **[Back]/[Next]**
Click the [Back] button to return to the original screen. The current settings are displayed by pressing the [Next] button. Click the [Submit] button to update the settings.

Note

- When you use the “Back” and “Forward” functions of your browser, a warning message “Page has Expired” may appear. In that case, click [Network config] again since the following operation will not be guaranteed.

■ [Adjust clock] page

Click [Detailed set up] → [Adjust clock].

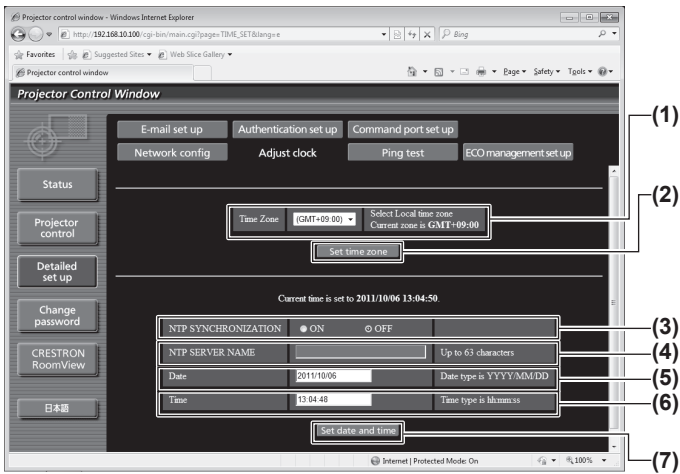

- (1) **[Time Zone]**
Selects the time zone. (Factory default: GMT +09:00)
- (2) **[Set time zone]**
Updates the time zone setting.
- (3) **[NTP SYNCHRONIZATION]**
Set to [ON] to adjust the date and time automatically.
- (4) **[NTP SERVER NAME]**
Enter the IP address or server name of the NTP server when you set to adjust the date and time manually. (To enter the server name, the setup of the DNS server is required.)
- (5) **[Date]**
Enter the date to be changed.
- (6) **[Time]**
Enter the time to be changed.
- (7) **[Set date and time]**
Updates the date and time settings.

Note

- The replacement of the battery inside the projector is required when the time goes out of alignment right after correcting the time. Consult your dealer.

[NETWORK] menu

[Ping test] page

You can check whether the network is connected to the E-mail server, POP server, DNS server, etc. Click [Detailed set up] → [Ping test].

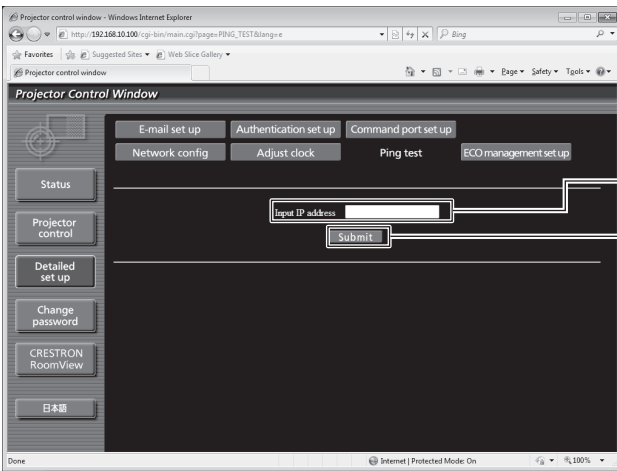

- (1) **[Input IP address]**
Enter the IP address of the server to be tested.
- (2) **[Submit]**
Executes the connection test.

```
PING 192.168.10.185 (192.168.10.185): 56 data bytes
64 bytes from 192.168.10.185: seq=0 ttl=128 time=1.960 ms
64 bytes from 192.168.10.185: seq=1 ttl=128 time=1.134 ms
64 bytes from 192.168.10.185: seq=2 ttl=128 time=1.144 ms
64 bytes from 192.168.10.185: seq=3 ttl=128 time=1.133 ms
--- 192.168.10.185 ping statistics ---
4 packets transmitted, 4 packets received, 0% packet loss
round-trip min/avg/max = 1.133/1.342/1.960 ms
```

- (3) **Example of display when the connection has succeeded**
- (4) **Example of display when the connection has failed**

```
PING 192.168.10.186 (192.168.10.186): 56 data bytes
--- 192.168.10.186 ping statistics ---
4 packets transmitted, 0 packets received, 100% packet loss
```

[ECO management set up] page

You can configure the settings regarding ECO management.

You can also configure the settings with [PROJECTOR SETUP] → [LAMP POWER], [PROJECTOR SETUP] → [ECO MANAGEMENT] → [AUTO POWER SAVE], [PROJECTOR SETUP] → [ECO MANAGEMENT] → [NO SIGNAL SHUT-OFF] of the projector.

Click [Detailed set up] → [ECO management set up].

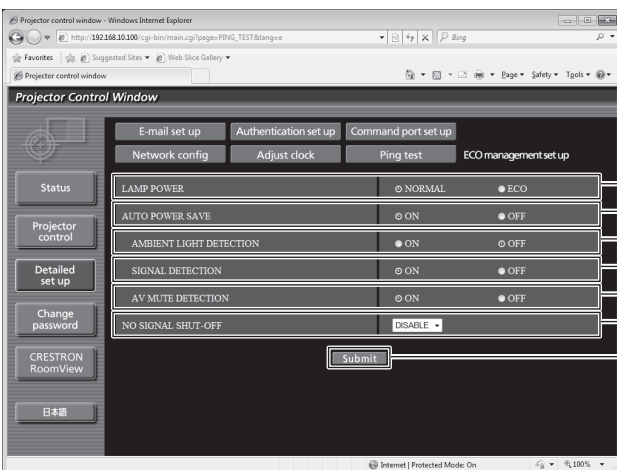

- (1) **[LAMP POWER]**
Displays the setting of the lamp power.
- (2) **[AUTO POWER SAVE]**
Selects the auto power save function.
- (3) **[AMBIENT LIGHT DETECTION]**
Selects the setting of ambient light detection.
- (4) **[SIGNAL DETECTION]**
Selects the setting of signal detection.
- (5) **[AV MUTE DETECTION]**
Selects the setting of AV mute detection.
- (6) **[NO SIGNAL SHUT-OFF]**
Selects the setting of No signal shut-off function.
- (7) **[Submit]**
Update the settings.

[E-mail set up] page

An E-mail message can be sent to the E-mail address setup in advance (up to two addresses) when the problem occurred or the lamp usage time reached the specified value.

Click [Detailed set up] → [E-mail set up].

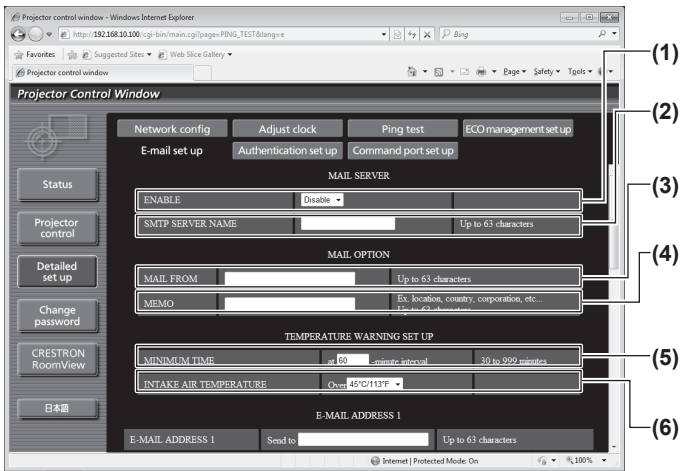

- (1) **[ENABLE]**
Select [ENABLE] when using the E-mail function.
- (2) **[SMTP SERVER NAME]**
Enter the IP address or the server name of the E-mail server (SMTP). To enter the server name, the setup of the DNS server is required.
- (3) **[MAIL FROM]**
Enter the E-mail address of the projector. (Up to 63 characters in single byte)
- (4) **[MEMO]**
You can enter information such as the location of the projector that notifies the sender of the E-mail. (Up to 63 characters in single byte)
- (5) **[MINIMUM TIME]**
Change the minimum intervals for the temperature warning mail. The default value is 60 minutes. In this case, another E-mail will not be sent for 60 minutes after sending the temperature warning mail even if it reaches the warning temperature.
- (6) **[INTAKE AIR TEMPERATURE]**
Change the temperature setting for the temperature warning mail. A temperature warning mail is sent when the temperature exceeds this value.

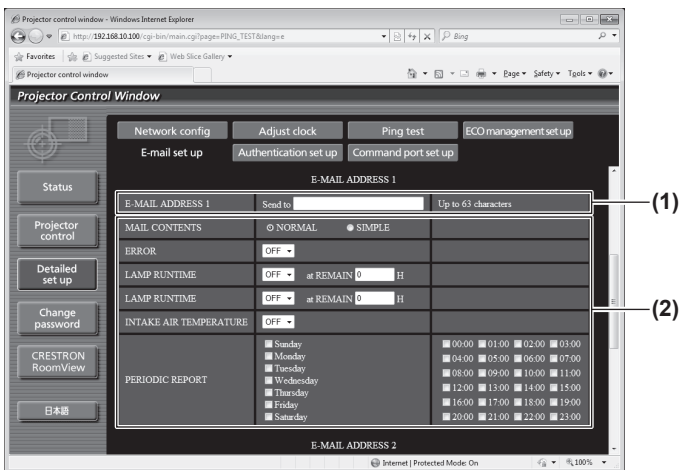

- (1) **[E-MAIL ADDRESS 1]**
Enter the E-mail address to be sent.
- (2) **Settings of the conditions to send E-mail**
Select the conditions to send E-mail.
[MAIL CONTENTS]:
Select either [NORMAL] or [SIMPLE].
[ERROR]:
An E-mail message is sent when an error occurred in the self-diagnosis.
[LAMP RUNTIME]:
An E-mail message is sent when the remaining lamp usage time has reached the value set at the right field.
[INTAKE AIR TEMPERATURE]:
An E-mail message is sent when the intake air temperature has reached the value set at the above field.
[PERIODIC REPORT]:
Place a check mark on this when E-mail is to be sent periodically.
It will be sent on the days and time with the check mark.

[NETWORK] menu

[E-mail set up] page (continued)

Projector Control Window

Network config | Adjust clock | Ping test | ECO management set up

E-mail set up | Authentication set up | Command port set up

E-MAIL ADDRESS 2

Send to: [] Up to 63 characters

MAIL CONTENTS: NORMAL SIMPLE

ERROR: OFF

LAMP RUNTIME: OFF at REMAIN [] H

LAMP RUNTIME: OFF at REMAIN [] H

INTAKE AIR TEMPERATURE: OFF

PERIODIC REPORT:

<input type="checkbox"/> Sunday	<input type="checkbox"/> 00:00	<input type="checkbox"/> 01:00	<input type="checkbox"/> 02:00	<input type="checkbox"/> 03:00
<input type="checkbox"/> Monday	<input type="checkbox"/> 04:00	<input type="checkbox"/> 05:00	<input type="checkbox"/> 06:00	<input type="checkbox"/> 07:00
<input type="checkbox"/> Tuesday	<input type="checkbox"/> 08:00	<input type="checkbox"/> 09:00	<input type="checkbox"/> 10:00	<input type="checkbox"/> 11:00
<input type="checkbox"/> Wednesday	<input type="checkbox"/> 12:00	<input type="checkbox"/> 13:00	<input type="checkbox"/> 14:00	<input type="checkbox"/> 15:00
<input type="checkbox"/> Thursday	<input type="checkbox"/> 16:00	<input type="checkbox"/> 17:00	<input type="checkbox"/> 18:00	<input type="checkbox"/> 19:00
<input type="checkbox"/> Friday	<input type="checkbox"/> 20:00	<input type="checkbox"/> 21:00	<input type="checkbox"/> 22:00	<input type="checkbox"/> 23:00
<input type="checkbox"/> Saturday				

Submit

(1) [E-MAIL ADDRESS 2]

Enter the E-mail address to be sent when two E-mail addresses are to be used.
Leave it blank when two E-mail addresses are not to be used.

(2) Settings of the conditions to send E-mail

Select the conditions to send E-mail to the second E-mail address.

[MAIL CONTENTS]:

Select either [NORMAL] or [SIMPLE].

[ERROR]:

An E-mail message is sent when an error occurred in the self-diagnosis.

[LAMP RUNTIME]:

An E-mail message is sent when the remaining lamp usage time has reached the value set at the right field.

[INTAKE AIR TEMPERATURE]:

An E-mail message is sent when the intake air temperature has reached the value set at the above field.

[PERIODIC REPORT]:

Place a check mark on this when E-mail is to be sent periodically to the second E-mail address. It will be sent on the days and time with the check mark.

(3) [Submit]

Update the settings.

■ [Authentication set up] page

You can set the authentication items when POP authentication or SMTP authentication is necessary to send an E-mail message.

Click [Detailed set up] → [Authentication set up].

- (1) **[Auth]**
Select the authentication method specified by your Internet service provider.
- (2) **[SMTP Auth]**
Set when the SMTP authentication is selected.
- (3) **[POP server name]**
Enter the POP server name. (Up to 63 characters in single byte)
Allowed characters:
Alphanumerics (A to Z, a to z, 0 to 9)
Minus sign (-) and period (.)
- (4) **[User name]**
Enter the user name for the POP server or the SMTP server. (Up to 63 characters in single byte)
- (5) **[Password]**
Enter the password for the POP server or the SMTP server. (Up to 63 characters in single byte)
- (6) **[SMTP server port]**
Enter the port number for the SMTP server. (Normally 25)
- (7) **[POP server port]**
Enter the port number for the POP server. (Normally 110)
- (8) **[Submit]**
Update the settings.

■ Contents of mail sent

● Example of E-mail sent when E-mail is set

The following E-mail is sent when the E-mail settings have been established.

```

=== Panasonic projector report(CONFIGURE) ===
Projector Type      : LZ370
Serial No          : SC1234567

--- E-mail setup data ---
TEMPERATURE WARNING SETUP
MINIMUM TIME       at [ 60] minutes interval
INTAKE AIR TEMPERATURE Over [ 32C / 89F ]

ERROR              [ OFF ]
LAMP RUNTIME       [ OFF ] at REMAIN [ 400] H
LAMP RUNTIME       [ OFF ] at REMAIN [ 200] H
INTAKE AIR TEMPERATURE [ OFF ]
PERIODIC REPORT
Sunday [ OFF ] Monday [ OFF ] Tuesday [ OFF ] Wednesday [ OFF ]
Thursday [ OFF ] Friday [ OFF ] Saturday [ OFF ]

00:00 [ OFF ] 01:00 [ OFF ] 02:00 [ OFF ] 03:00 [ OFF ]
04:00 [ OFF ] 05:00 [ OFF ] 06:00 [ OFF ] 07:00 [ OFF ]
08:00 [ OFF ] 09:00 [ OFF ] 10:00 [ OFF ] 11:00 [ OFF ]
12:00 [ OFF ] 13:00 [ OFF ] 14:00 [ OFF ] 15:00 [ OFF ]
16:00 [ OFF ] 17:00 [ OFF ] 18:00 [ OFF ] 19:00 [ OFF ]
20:00 [ OFF ] 21:00 [ OFF ] 22:00 [ OFF ] 23:00 [ OFF ]

--- check system ---
MAIN CPU BUS           [ OK ]
FAN                    [ OK ]
INTAKE AIR TEMPERATURE [ OK ]
EXHAUST AIR TEMPERATURE [ OK ]
LAMP REMAIN TIME       [ OK ]
LAMP STATUS            [ OK ]
APERTURE(CONTRAST-SHUTTER) [ OK ]
INTAKE AIR TEMP.SENSOR [ OK ]
EXHAUST AIR TEMP.SENSOR [ OK ]
BATTERY                [ OK ]
AIR FILTER             [ OK ]
(Error code 00 00 00 00 00 00 00)
    
```

● Example of E-mail sent for an error

The following E-mail is sent when an error has occurred.

```

=== Panasonic projector report(ERROR) ===
Projector Type      : LZ370
Serial No          : SC1234567

--- check system ---
MAIN CPU BUS           [ FAILED ]
FAN                    [ OK ]
INTAKE AIR TEMPERATURE [ OK ]
EXHAUST AIR TEMPERATURE [ OK ]
LAMP REMAIN TIME       [ OK ]
LAMP STATUS            [ OK ]
APERTURE(CONTRAST-SHUTTER) [ OK ]
INTAKE AIR TEMP.SENSOR [ OK ]
EXHAUST AIR TEMP.SENSOR [ OK ]
BATTERY                [ OK ]
AIR FILTER             [ OK ]
(Error code 80 00 00 00 30 00 00)

Intake air temperature : 27 degC / 80 degF
Exhaust air temperature : 39 degC / 102 degF
PROJECTOR RUNTIME      2 H
LAMP ON                10 times
LAMP ECO                0 H
LAMP NORMAL            2 H
LAMP REMAIN            1998 H
--- Current status ---
MAIN VERSION           1.00
NETWORK VERSION        1.00
SUB VERSION            1.00
LAMP STATUS            LAMP=OFF
INPUT SIGNAL           COMPUTER

--- Wired Network configuration ---
DHCP Client            OFF
IP address              10.69.104.183
MAC address             00:40:64:00:02:08

Fri Sep 30 19:52:37 2011
    
```

■ [Command port set up] page

Set the port number used for command control.
Click [Detailed set up] → [Command port set up].

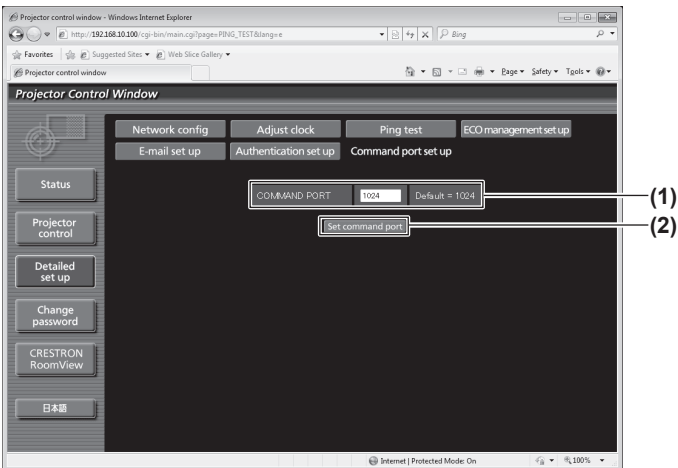

- (1) **[COMMAND PORT]**
Set the port number used for command control.
- (2) **[Set command port]**
Update the settings.

■ [Change password] page

Click [Change password].

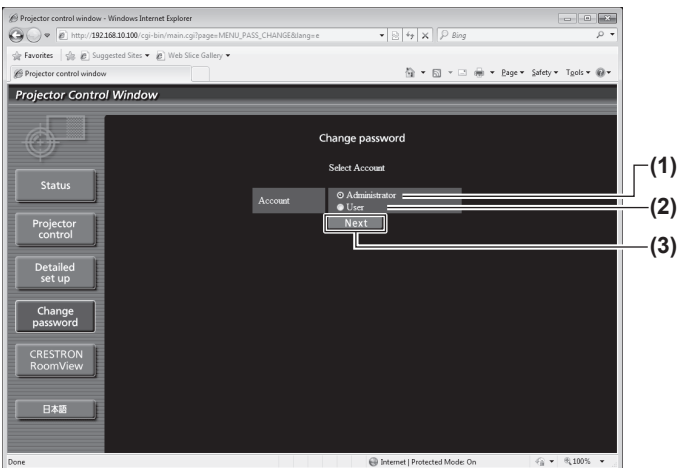

- (1) **[Administrator]**
Used to change the setting of [Administrator].
- (2) **[User]**
Used to change the setting of [User].
- (3) **[Next]**
Used to change the setting of the password.

● [Administrator] account

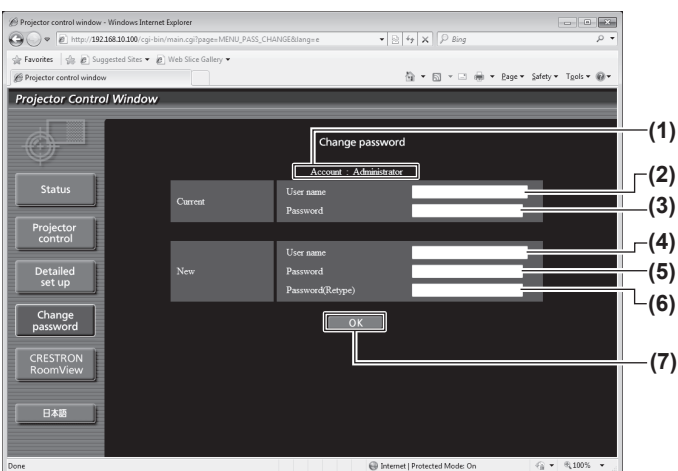

- (1) **[Account]**
Displays the account to change.
- (2) **[Current] [User name]**
Enter the user name before the change.
- (3) **[Current] [Password]**
Enter the current password.
- (4) **[New] [User name]**
Enter the desired new user name. (Up to 16 characters in single byte)
- (5) **[New] [Password]**
Enter the desired new password. (Up to 16 characters in single byte)
- (6) **[New] [Password(Retype)]**
Enter the desired new password again.
- (7) **[OK]**
Determines the change of password.

[NETWORK] menu

● [User] account

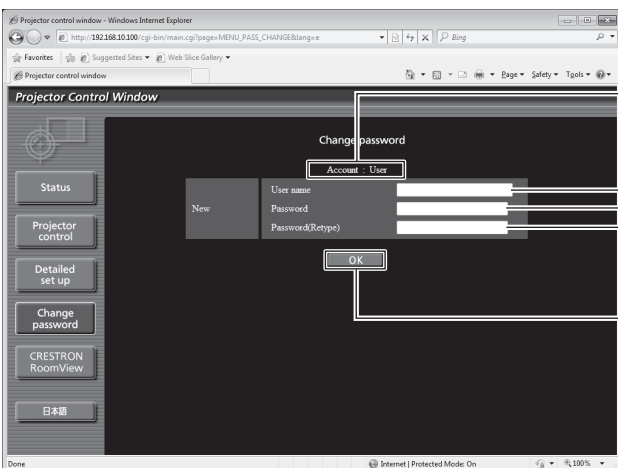

- (1) **[Account]**
Displays the account to change.
- (2) **[New] [User name]**
Enter the desired new user name. (Up to 16 characters in single byte)
- (3) **[New] [Password]**
Enter the desired new password. (Up to 16 characters in single byte)
- (4) **[New] [Password(Retype)]**
Enter the desired new password again.
- (5) **[OK]**
Determines the change of password.

● [Change password] (For user rights)

Only the change of password is enabled under the user rights.

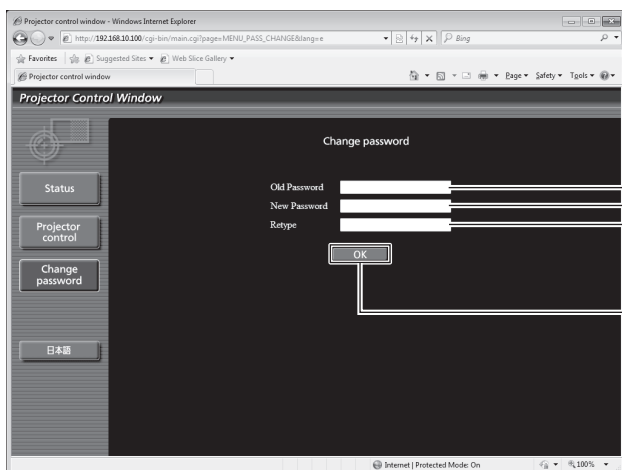

- (1) **[Old Password]**
Enter the current password.
- (2) **[New Password]**
Enter the desired new password. (Up to 16 characters in single byte)
- (3) **[Retype]**
Enter the desired new password again.
- (4) **[OK]**
Determines the change of password.

Note

- To change the account of the administrator, it is required to enter [User name] and [Password] in [Current].

■ [CRESTRON RoomView] page

You can monitor/control the projector using RoomView.

To display the operation page of RoomView from Web Control screen, access with the administrator rights is required. (The [CRESTRON RoomView] button is not displayed on the Web Control screen for user rights.)

When you click [CRESTRON RoomView], the RoomView operation page is displayed.

If Adobe Flash Player is not installed in your computer, or if the browser does not support Flash, this page does not appear. In this case, return to the previous page by clicking [Back] in the operation page.

● Operation page

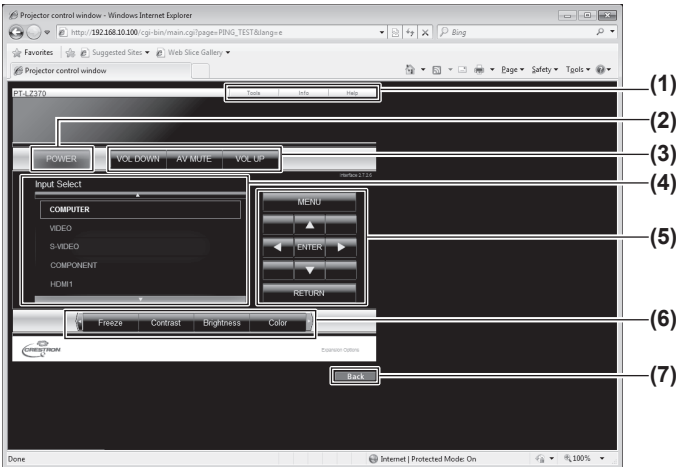

- (1) **[Tools] [Info] [Help]**
Switches the pages for tools/information/help using the tab.
- (2) **[POWER]**
Switches between on and off of the power.
- (3) **[VOL DOWN] [AV MUTE] [VOL UP]**
Sets the volume/AV mute.
When the power of the projector is turned off, [VOL DOWN], [AV MUTE], and [VOL UP] are not available.
- (4) **[Input Select]**
Sets the input selection.
When the power of the projector is turned off, this operation is not available.
- (5) **Operation buttons on the menu screen**
Operates on the menu screen.
- (6) **Freeze/image quality adjustment**
Sets freeze/image quality details.
- (7) **[Back]**
Returns to the previous page.

● [Tools] page

Click [Tools] on the operation page.

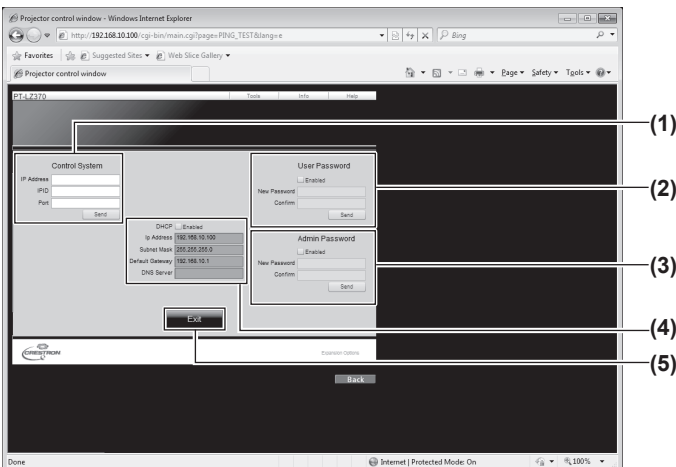

- (1) **[Control System]**
Sets the information required for the communication with the controller that is connected to the projector.
- (2) **[User Password]**
Sets the password for the user rights in the operation page of RoomView.
- (3) **[Admin Password]**
Sets the password for the administrator rights in the operation page of RoomView.
- (4) **Network status**
Displays the setting of wired LAN.
[DHCP]
Displays the value in the current setting.
[Ip Address]
Displays the value in the current setting.
[Subnet Mask]
Displays the value in the current setting.
[Default Gateway]
Displays the value in the current setting.
[DNS Server]
Displays the value in the current setting.
- (5) **[Exit]**
Returns to the operation page.

[NETWORK] menu

● [Info] page

Click [Info] on the operation page.

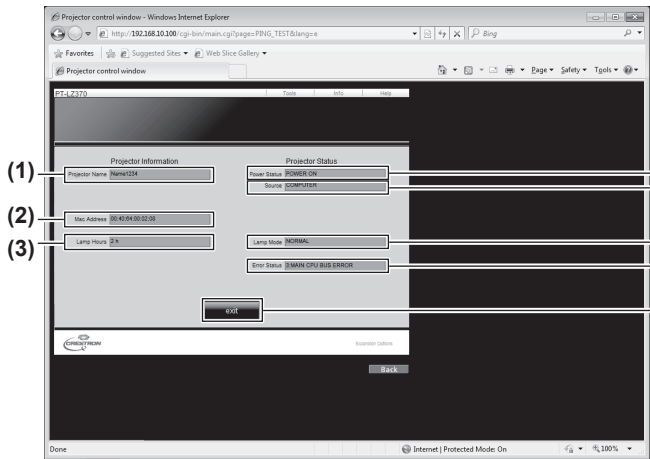

- (1) **[Projector Name]**
Displays the name of the projector.
- (2) **[Mac Address]**
Displays the MAC address.
- (3) **[Lamp Hours]**
Displays the lamp usage time (converted value).
- (4) **[Power Status]**
Displays the status of the power.
- (5) **[Source]**
Displays the selected video input.
- (6) **[Lamp Mode]**
Displays the lamp mode.
- (7) **[Error Status]**
Displays the error status.
- (8) **[exit]**
Returns to the operation page.

● [Help] page

Click [Help] on the operation page.
The [Help Desk] screen is displayed.

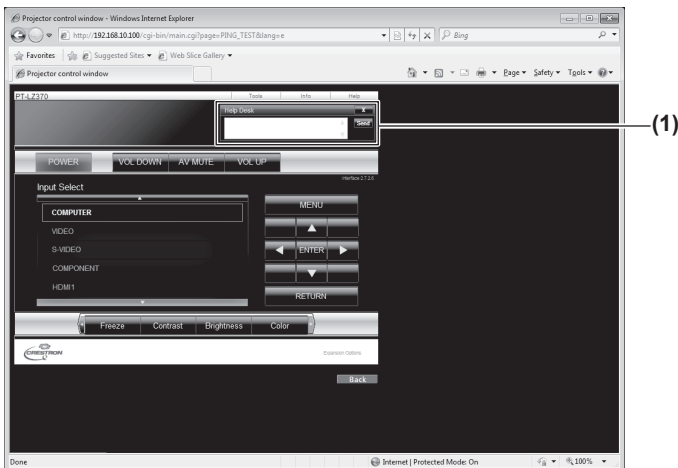

- (1) **[Help Desk]**
Sends or receive messages to the administrator who uses Crestron RoomView.

<LAMP> and <TEMP> indicators

Managing the indicated problems

If a problem should occur inside the projector, the lamp indicator <LAMP> and the temperature indicator <TEMP> will inform you.

Manage the indicated problems as follows.

Attention

- When switching off the power to deal with problems, make sure to follow the procedure in “Switching off the projector” (➡ page 36).

Note

- Check the status of the power supply with the power indicator <ON (G)/STANDBY (R)>. (➡ page 34)

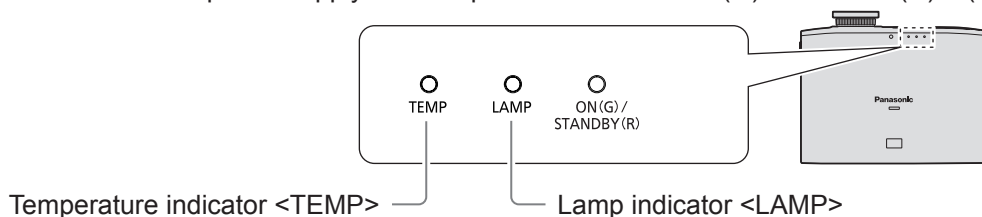

■ Lamp indicator <LAMP>

Indicator status	Illuminating red	Flashing red	
Problem	Time to replace the lamp unit. (➡ page 101)	Lamp circuit failure, abnormal function, or lamp unit is damaged.	
Cause	<ul style="list-style-type: none"> ● Is [REPLACE LAMP] displayed when you turned on the power? ● The indicator illuminates when the lamp usage time (converted value)*1 reaches 2 800 hours. 	<ul style="list-style-type: none"> ● Have you turned on the power again immediately after turning it off? 	<ul style="list-style-type: none"> ● Lamp circuit failure, abnormal function, or lamp unit is damaged.
Solution	<ul style="list-style-type: none"> ● Replace the lamp unit. 	<ul style="list-style-type: none"> ● Wait a while until the luminous lamp cools off and turn off the main power, and then turn on the power again. 	<ul style="list-style-type: none"> ● Turn the <MAIN POWER> switch to <OFF> (➡ page 36), and consult your dealer.

*1: The lamp usage time (converted value) is displayed in the [PROJECTOR SETUP] menu → [LAMP RUNTIME] (➡ page 66).

Note

- If the lamp indicator <LAMP> is still illuminating or flashing after taking the preceding measures, ask your dealer to repair the unit.

<LAMP> and <TEMP> indicators

■ Temperature indicator <TEMP>

Indicator status	<ul style="list-style-type: none"> ● Illuminates red during projection. (The message [REFER TO THE “TEMP indicator” SECTION IN THE OPERATION MANUAL.] is displayed on the projection screen.) ● Flashing red when the power is turned off (projection stops automatically). 			
Problem	The temperature inside and/or outside the projector is abnormally high.			
Cause	<ul style="list-style-type: none"> ● Is the ventilating port (intake/exhaust) blocked? 	<ul style="list-style-type: none"> ● Is the room temperature too high? 	<ul style="list-style-type: none"> ● Is the air filter unit clogged? 	<ul style="list-style-type: none"> ● Is the projector used at high elevations 1 400 m (4 593 ft) or higher sea level?
Solution	<ul style="list-style-type: none"> ● Remove any objects that are blocking the ventilating port (intake/exhaust). 	<ul style="list-style-type: none"> ● Place the projector in an environment with temperature and humidity as designated in the specifications. (➡ page 117) 	<ul style="list-style-type: none"> ● Clean or replace the air filter unit. (➡ page 97) 	<ul style="list-style-type: none"> ● The projector can only be used for two minutes after turning on the power. Set [HIGH ALTITUDE MODE] (➡ page 65) to [ON] within two minutes of turning on the power.

Note

- If the temperature indicator <TEMP> is still illuminating or flashing after taking the preceding measures, ask your dealer to repair the unit.

Maintenance/replacement

Before maintaining/replacing the unit

- Make sure to turn off the power before maintaining or replacing the unit. (➡ pages 33, 36)
- When turning off the power, make sure to follow the procedures in “Switching off the projector” (➡ page 36).

Maintenance

Outer case

Wipe off dirt and dust with a soft, dry cloth.

- If the dirt is persistent, soak the cloth with water and wring it thoroughly before wiping. Dry off the projector with a dry cloth.
- Do not use benzene, thinner, or rubbing alcohol, other solvents, or household cleaners. Using them may cause deterioration of the outer case.
- When using chemical treated dusters, follow the instructions.

Lens

If dirt or dust accumulates on the surface of the lens, it will be enlarged and projected onto the screen.

Wipe off dirt and dust off the front surface of the lens with a soft clean cloth.

- Do not use a cloth that is fluffy, dusty, or soaked with oil/water.
- Do not use excessive force when wiping the lens as it is fragile.

Attention

- The lens is made of glass. Impacts or excessive force when wiping may scratch its surface. Please handle with care.

Air filter unit

If too much dust accumulates in the air filter unit, the internal temperature of the projector cannot be maintained at the normal level. A confirmation message is displayed on the screen, and at the same time the temperature indicator <TEMP> illuminates red. The power is cut off automatically after a while. In such a case, clean the air filter unit.

1) Remove the air filter cover.

- Use a Phillips screwdriver to turn the air filter cover fixing screw until it turns freely, and then remove the air filter cover.

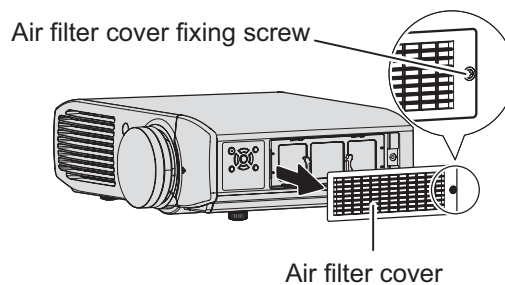

Maintenance/replacement

2) Pull out the air filter unit.

- Hold the grips on the air filter unit and pull out the air filter unit from the projector.

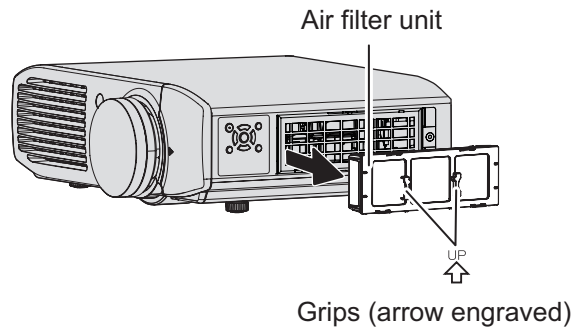

- After removing the air filter unit, remove any large build ups of dirt or dust in the air filter unit bay and the air intake port on the projector.

3) Clean the air filter unit.

- Vacuum dirt and dust from the air filter unit.

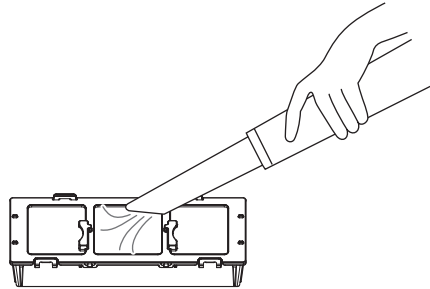

4) Attach the air filter unit to the projector.

- Perform Step 2) in the reverse order.
- Insert the air filter unit into the projector in the direction of the arrow engraved into the air filter frame (↑) until it clicks into place.

5) Attach the air filter cover to the projector and use a Phillips screwdriver to tighten the air filter cover fixing screw (one screw).

- Perform Step 1) in the reverse order.

Attention

- Make sure that the air filter is properly attached before using the projector. If it is not properly attached, the projector will suck in dirt and dust causing a malfunction.
- Do not use water to wash the air filter unit. Doing so decreases its ability to absorb dust.

Replacing the unit

■ Air filter and electrostatic filter

The air filter should be replaced when cleaning is ineffective.

The replacement air filter and electrostatic filter (TXFKN01RYNZP) are sold separately. (Service component)

To purchase the product, consult your dealer.

Replace the air filter and electrostatic filter whenever replacing the lamp unit.

(An air filter and electrostatic filter are included with the replacement lamp unit ET-LAA110.)

■ Replacing the air filter and electrostatic filter

1) Remove the air filter cover.

- Use a Phillips screwdriver to turn the air filter cover fixing screw until it turns freely, and then remove the air filter cover.

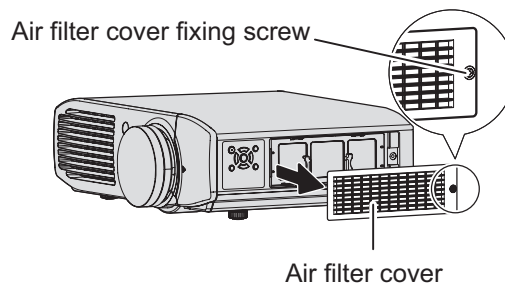

2) Pull out the air filter unit.

- Hold the grips on the air filter unit and pull out the air filter unit from the projector.

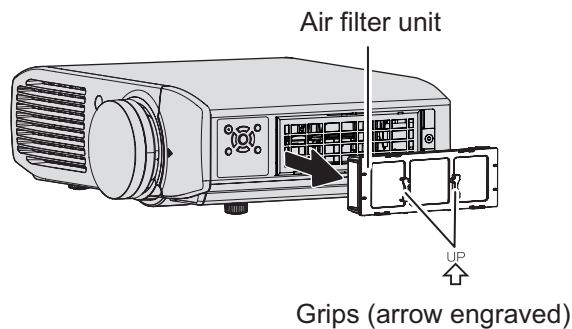

- After removing the air filter unit, remove any large build ups of dirt or dust in the air filter unit bay and the air intake port on the projector.

3) Press the protrusions of air filter unit removed from the projector in the direction of the arrow and remove the air filter frame.

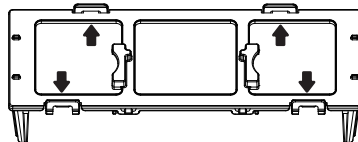

4) Replace the air filter and electrostatic filter.

- Replace the air filter and electrostatic filter in the air filter unit with new ones.
- Ensure that you attach the electrostatic filter and air filter in the correct order.

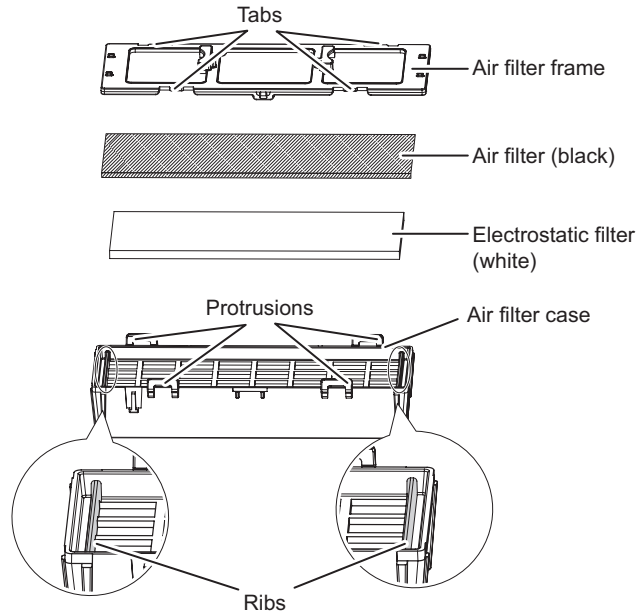

5) Assemble the air filter unit.

- First insert the electrostatic filter (white) into the center of the case ensuring that its edges do not ride on top of the ribs. And then insert the air filter (black) so that its four corners are within the case before attaching the air filter frame.
- Take care so that the air filter does not get caught between the air filter frame and the case.
- Align the catches and protrusions on the air filter case and air filter frame when assembling the air filter unit. When attaching the air filter frame, ensure that the four catches are properly aligned with the protrusions on the air filter case and they have clicked into place.

6) Attach the air filter unit to the projector.

- Attach the air filter unit to the projector using the reverse of Step 2).
- Insert the air filter unit into the projector in the direction of the arrow engraved into the air filter frame (UP) until it clicks into place.

7) Attach the air filter cover to the projector and use a Phillips screwdriver to tighten the air filter cover fixing screw (one screw).

■ Lamp unit

The lamp unit is a consumable component. Refer to “When to replace the lamp unit” (➔ page 101) for details about the lifespan.

Consult your dealer to purchase a replacement lamp unit (ET-LAA110: Service component).

It is recommended that you request a qualified technician to replace the lamp unit. Consult your dealer.

Attention

- Do not replace the lamp unit when it is hot. (Wait at least one hour after use.) The inside of the cover can become very hot, take care to avoid burn injuries.

Notes on the replacement of the lamp unit

- A Phillips screwdriver is necessary when replacing the lamp unit.
- Since the luminous lamp is made of glass, it may burst if dropped or hit with a hard object. Please handle with care.
- Do not disassemble or modify the lamp unit.
- When replacing the lamp unit, be sure to hold it by the handle.

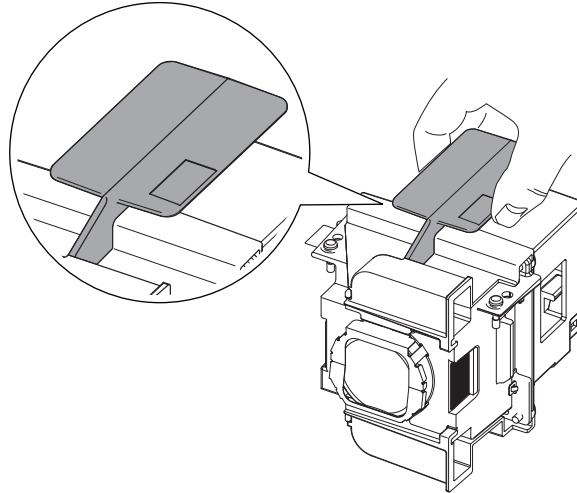

- The lamp may burst. Replace the lamp unit carefully so that the broken pieces of the lamp glass will not scatter. When the projector is mounted on the ceiling, do not make the replacement directly under the lamp unit or put your face near it.
- The lamp contains mercury. When disposing of used lamp units, contact your local authorities or dealer for correct methods of disposal.

Attention

- Use only specified lamp units.

When to replace the lamp unit

The lamp unit is a consumable component. Since its brightness gradually decreases over time, it is necessary to replace it regularly. The estimated duration before replacement is 3 000 hours. However, this may be shortened depending on individual lamp characteristics, usage conditions, and the installation environment. Therefore, it is strongly recommended that a replacement lamp unit be kept.

As the risk of the lamp to cracking increases after 3 000 hours*¹ the lamp automatically turns off after approximately ten minutes.

	On screen	Lamp indicator
Over 2 800*¹ hours	The message is displayed for 30 seconds. Pressing any button on the control panel or remote control within 30 seconds will clear the message.	Illuminates red even during the standby mode.
Over 3 000*¹ hours	The message remains displayed until you press any button.	

*1: The lamp usage time (converted value) is displayed in the [PROJECTOR SETUP] → [LAMP RUNTIME] (➡ page 66).

Note

- To estimate the lamp replacement timing, check the lamp usage time (converted value) displayed in [LAMP RUNTIME] (➡ page 66) of [PROJECTOR SETUP].
- The usage period of 3 000 hours is a rough estimate and is not guaranteed.

■ Replacing the lamp unit

Attention

- Once a lamp unit has exceeded its lifespan of 3 000 hours (the lamp usage time (converted value)) the projector can only be used for ten minutes after turning on the power. (➔ page 101)
Perform Steps 14) to 17) within ten minutes.
- When the projector is mounted on the ceiling, do not put your face near the lamp unit.
- Do not open the top cover except when replacing the lamp unit.
- Do not switch on the power while the top cover is opened.
- Replace the air filter and electrostatic filter whenever replacing the lamp unit.
- Securely attach the lamp unit and lamp unit cover.

1) Follow the procedures described in “Switching off the projector” (➔ page 36), press the <OFF> side of the <MAIN POWER> switch to turn off the power, disconnect the power plug from the power outlet, and wait at least one hour, and then check if the lamp unit has cooled down.

2) Remove the video cable connected to the connecting terminal.

Attention

- If you open the top panel fully, it may come into contact with connectors such as the video cable which may result in breakage of the video cable. Before opening the top panel, be sure to remove the connected video cables, etc.

3) Hold the protrusions at the front corner of the top cover of the projector and push up to open the top cover.

- When the projector is mounted on the ceiling, stand at the lens side of the projector when opening/closing the top cover.

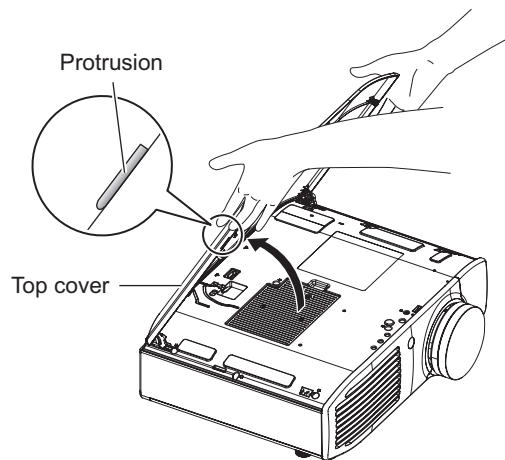

Attention

- Be careful not to open the top panel too far. For what to do if the top panel comes off, see “When to replace the lamp unit” (➔ page 101).

- 4) Use a Phillips screwdriver to turn the lamp cover fixing screw (one screw) until it turns freely, and then remove the lamp cover.
- Slowly remove the lamp cover from the projector.

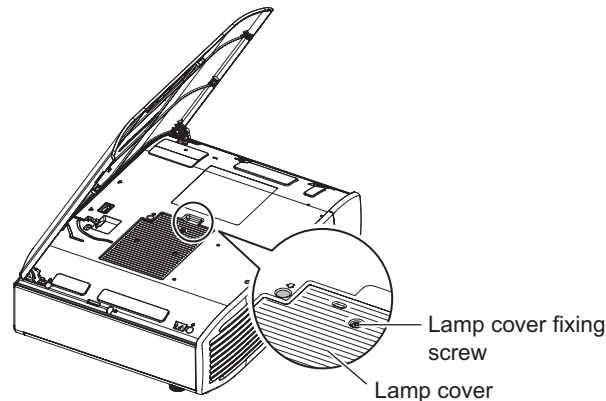

- 5) Use a Phillips screwdriver to turn the lamp unit fixing screws (two screws) until it turns freely.
- 6) Hold the handle of the lamp unit and with the lamp unit lock held in the direction of the arrow, carefully pull it out of the projector unit in a vertical motion.

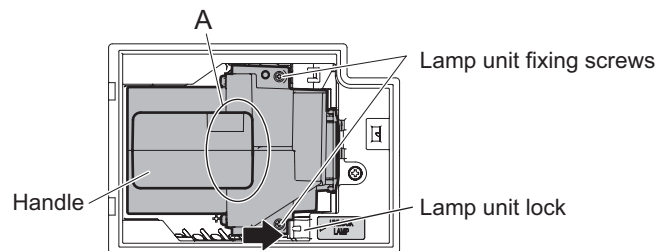

- 7) Insert the new lamp unit while making sure that the direction is correct and use a Phillips screwdriver to tighten the lamp unit screws (two screws).
- Press down on the A part firmly when inserting the lamp unit.
- 8) Attach the lamp cover and use a Phillips screwdriver to tighten the lamp cover fixing screw (one screw).
- 9) Close the top cover of the projector.
- Close the top cover using the reverse of Step 3), and press the center of the top cover.
- 10) Reconnect the video cable disconnected in 2) to the connecting terminal.
- 11) Replace the air filter and electrostatic filter.
- Refer to "Replacing the air filter and electrostatic filter" (➡ page 99) for details about the procedure.
- 12) Insert the power plug into a power outlet, and press the <ON> side of the <MAIN POWER> switch to turn on the power.

Maintenance/replacement

- 13) Press the power <⏻/|> button on the control panel or on the remote control to start video projection.
- 14) Press the <MENU> button to display the menu screen and then press ▲▼ to select [PROJECTOR SETUP].
- 15) Press the <ENTER> button and then press ▲▼ to select [LAMP RUNTIME].
- 16) Hold the <ENTER> button for approximately three seconds.
 - The [LAMP RUNTIME] confirmation message is displayed.

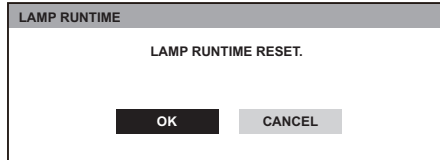

- 17) Press ◀▶ to select [OK], and press the <ENTER> button.
 - The lamp usage time (converted value) is reset to 0 and the power is turned off. After a short while, the projector enters the standby mode.

■ Attaching the top cover

Hold the top cover as shown in the following figure, align the hinge with the support, and while pushing the arm in the direction of the arrow (towards the inner side of the projector), push it into the groove.

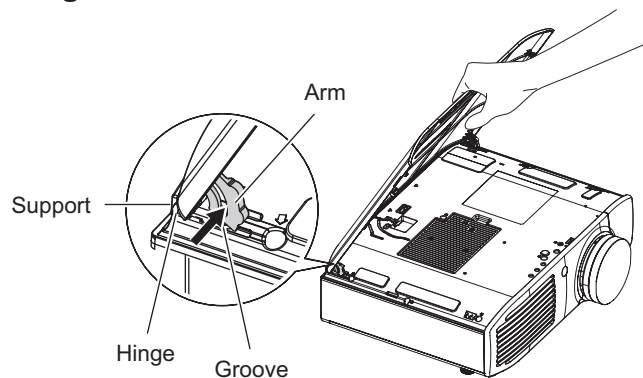

Troubleshooting

Review the following points. For details, see the corresponding pages.

Problem	Points to be checked	Page
Power does not turn on.	● Is the power plug firmly inserted into an outlet?	—
	● Is the <MAIN POWER> switch turned <OFF>?	36
	● Is the wall outlet supplying electricity?	—
	● Have the circuit breakers tripped?	—
	● Is the lamp indicator <LAMP> or the temperature indicator <TEMP> illuminating or flashing?	95, 96
	● Is the lamp unit securely installed?	102
No picture appears.	● Is the connection to the picture (output) device correct?	30
	● Is the input selection setting correct?	40
	● Is the [BRIGHTNESS] adjustment setting at a minimum?	47
	● Is the external device that is connected to the projector working properly?	—
	● Is the AV mute function in use?	39
	● Is the lens cover still attached to the lens?	35
The picture is fuzzy.	● Is the lens focus set correctly?	37
	● Is the projection distance appropriate?	24
	● Is the lens dirty?	15
	● Is the projector installed perpendicular to the screen?	—
The color is pale or grayish.	● Is [COLOR] adjusted correctly?	47
	● Is [TINT] adjusted correctly?	47
	● Is the device connected to the projector adjusted correctly?	30
Audio is not output.	● Is the <AUDIO IN> terminal connected correctly?	21
	● Is the volume adjusted at a minimum?	41
	● Is the AV mute function used?	39
	● Check [AUDIO IN SELECT] in [AUDIO SETTING].	70
The remote control does not operate.	● Are the batteries depleted?	—
	● Is the polarity of the batteries set correctly?	22
	● Are there any obstructions between the remote control and the projector's remote control signal receiver?	19
	● Is the remote control being used beyond its effective operation range?	19
	● Are other forms of light, such as fluorescent lights, affecting the projection?	19
	● Is the [REMOTE CONTROLLER] setting in [CONTROL DEVICE SETUP] set to [DISABLE]?	75
	● Is the ID number setting operation correct?	22

Troubleshooting

Problem	Points to be checked	Page
The buttons on the control panel do not operate.	<ul style="list-style-type: none"> ● Is the [CONTROL PANEL] setting in [CONTROL DEVICE SETUP] set to [DISABLE]? 	75
The picture does not display correctly.	<ul style="list-style-type: none"> ● Is [TV-SYSTEM] set correctly? 	53
	<ul style="list-style-type: none"> ● Is [RGB/YC_BC_R] or [RGB/YP_BP_R] set correctly? 	53
	<ul style="list-style-type: none"> ● Is there a problem with the video tape or other picture sources? 	—
	<ul style="list-style-type: none"> ● Is a signal which is not compatible with the projector input? 	114
Picture from a computer does not appear.	<ul style="list-style-type: none"> ● Is the cable too long? (Use a cable that is 10 m (32'10") or shorter.) 	—
	<ul style="list-style-type: none"> ● Is the external video output of the laptop computer set correctly? – Example: The external output settings may switch by pressing the Fn + F3 keys simultaneously. Since the method varies depending on the computer type, refer to the user manual provided with your computer. 	60
Video from HDMI compatible device does not appear or it appears jumbled.	<ul style="list-style-type: none"> ● Is the HDMI cable connected securely? 	32
	<ul style="list-style-type: none"> ● Turn off and on the power of the projector and the external device. 	33
	<ul style="list-style-type: none"> ● Is a signal which is not compatible with the projector input? 	114
Audio from HDMI compatible device is not output.	<ul style="list-style-type: none"> ● Set the audio of the external device to the linear PCM. 	—
	<ul style="list-style-type: none"> ● Check [AUDIO IN SELECT] in [AUDIO SETTING]. 	70
	<ul style="list-style-type: none"> ● If audio is not output with the HDMI cable connection, use the <AUDIO IN> terminal. 	21
Projection starts while the power button is not pressed.	<ul style="list-style-type: none"> ● Is [ON] set for the [PROJECTOR SETUP] menu → [INITIAL START UP]? 	65
	<ul style="list-style-type: none"> ● Did you turn the <MAIN POWER> switch to <OFF> in the middle of projection when you last used the projector? – When [LAST MEMORY] is set for the [PROJECTOR SETUP] menu → [INITIAL START UP] and the projector was turned off with the direct power off function (➡ page 36) in the last use, projection starts when the <MAIN POWER> switch is turned to <ON>. 	35
	<ul style="list-style-type: none"> ● Did you press the power <⏻/⏻> button immediately after turning the <MAIN POWER> switch to <OFF>? – When [LAST MEMORY] is set for the [PROJECTOR SETUP] menu → [INITIAL START UP] and the power <⏻/⏻> button is pressed immediately after the <MAIN POWER> switch is turned to <OFF>, the projector may start projection when the <MAIN POWER> switch is turned to <ON> on the next start-up. 	—
	<ul style="list-style-type: none"> – After turning the <MAIN POWER> switch to <OFF>, do not press the power <⏻/⏻> button on the remote control or the control panel of the projector body while the power indicator <ON (G)/STANDBY (R)> is illuminating or flashing red. 	

Attention

- If problems persist even after checking the preceding points, consult your dealer.

Technical information

PJLink protocol

The network function of this projector supports the PJLink class 1, and the PJLink protocol can be used to perform projector setting and projector status query operations from a computer.

Control command

The following table lists the PJLink protocol commands that can be used to control the projector.

Command	Control details	Notes
POWR	Power supply control	Parameters 0 = Standby 1 = Power on
POWR?	Power supply status query	Parameters 0 = Standby 2 = Cool-down in progress 1 = Power on 3 = Warm-up in progress
INPT	Input selection	Parameters
INPT?	Input selection query	11 = COMPUTER 22 = S-VIDEO 31 = HDMI 1 21 = VIDEO 23 = COMPONENT 32 = HDMI 2
AVMT	AV mute control	Parameters
AVMT?	AV mute status query	30 = AV mute function off 31 = AV mute function on
ERST?	Error status query	Parameters 1st byte: Indicates fan errors, range 0 - 2 2nd byte: Indicates lamp errors, range 0 - 2 3rd byte: Indicates temperature errors, range 0 - 2 4th byte: Fixed to 0 5th byte: Indicates a warning about a filter, range 0 - 2 6th byte: Indicates other errors, range 0 - 2 Definitions for each value from 0 to 2 are as follows 0 = No error detected 1 = Warning 2 = Error
LAMP?	Lamp status query	Parameters 1st digits (1 - 5 digits): Lamp cumulative operating time 2nd digit: 0 = Lamp Off, 1 = Lamp On
INST?	Input selection list query	Parameters are returned with the following values. "11 21 22 23 31 32"
NAME?	Projector name query	Returns the name set in [NAME CHANGE] of [NETWORK].
INF1?	Manufacturer name query	Returns "Panasonic".
INF2?	Model name query	Returns "LZ370".
INF0?	Other information query	Returns information such as version number.
CLSS?	Class information query	Returns "1".

Technical information

■ PJLink security authentication

The password used for PJLink is the same as that of the password set for the web browser control. When using PJLink without security authentication, do not set a password for the web browser control.

- For specifications regarding PJLink, refer to the Japan Business Machine and Information System Industries Association website.
URL <http://pjlink.jbmia.or.jp/english/>

Control commands via LAN

■ When Web Control administrator rights password is set (Protect mode)

● Connection method

1) Obtain the IP address and port number (Initial set value = 1024) of the projector and request for a connection to the projector.

You can obtain the IP address from the menu screen of the projector, and the port number from the Web Control page.

IP address	Obtain from the main menu → [NETWORK] → [STATUS]
Port No.	Obtain from Web Control [Detailed set up] → [Command port set up] page

2) Check the response from the projector.

Response data

Data section	Blank	Mode	Blank	Random number section	Termination symbol
"NTCONTROL" (ASCII string)	' '	'1'	' '	"ZZZZZZZZ" (ASCII code hexadecimal number)	(CR) 0x0d
9 bytes	1 byte	1 byte	1 byte	8 bytes	1 byte

Mode: 1 = Protect mode

3) Generate a 32-byte hash value from the following data using MD5 algorithm.

"xxxxxx:yyyyy:zzzzzzzz"

xxxxxx	Administrator rights user name for Web Control (default user name is "admin1").
yyyyy	Password of above administrator rights user (default password is "panasonic").
zzzzzzzz	8-byte random number obtained in Step 2)

● Command transmission method

Transmit using the following command formats.

Transmitted data

Header			Data section	Termination symbol
Hash value ("Connection method" (→ page 108)) 32 bytes	'0' 0x30 1 byte	'0' 0x30 1 byte	Control command (ASCII string) Undefined length	(CR) 0x0d 1 byte

Received data

Header		Data section	Termination symbol
'0' 0x30 1 byte	'0' 0x30 1 byte	Control command (ASCII string) Undefined length	(CR) 0x0d 1 byte

Error response

Error message		Termination symbol
"ERR1"	Undefined control command	(CR) 0x0d 1 byte
"ERR2"	Out of parameter range	
"ERR3"	Busy state or no-acceptable period	
"ERR4"	Timeout or no-acceptable period	
"ERR5"	Wrong data length	
"ERRA"	Password mismatch	
4 bytes		

■ When Web Control administrator rights password is not set (Non-protect mode)

● Connection method

1) Obtain the IP address and port number (Initial set value = 1024) of the projector and request for a connection to the projector.

You can obtain the IP address from the menu screen of the projector, and the port number from the Web Control page.

IP address	Obtain from the main menu → [NETWORK] → [STATUS]
Port No.	Obtain from Web Control [Detailed set up] → [Command port set up] page

2) Check the response from the projector.

Response data

Data section	Blank	Mode	Termination symbol
“NTCONTROL” (ASCII string) 9 bytes	‘ ’ 0x20 1 byte	‘0’ 0x30 1 byte	(CR) 0x0d 1 byte

Mode: 0 = Non-protect mode

● Command transmission method

Transmit using the following command formats.

Transmitted data

Header		Data section	Termination symbol
‘0’ 0x30 1 byte	‘0’ 0x30 1 byte	Control command (ASCII string) Undefined length	(CR) 0x0d 1 byte

Received data

Header		Data section	Termination symbol
‘0’ 0x30 1 byte	‘0’ 0x30 1 byte	Control command (ASCII string) Undefined length	(CR) 0x0d 1 byte

Error response

Error message		Termination symbol
“ERR1”	Undefined control command	(CR) 0x0d 1 byte
“ERR2”	Out of parameter range	
“ERR3”	Busy state or no-acceptable period	
“ERR4”	Timeout or no-acceptable period	
“ERR5”	Wrong data length	
“ERRA”	Password mismatch	
4 bytes		

<SERIAL> terminal

The <SERIAL> terminal of the projector conforms with RS-232C so that the projector can be connected to and controlled from a computer.

■ Connection

<Connecting terminals on projector>

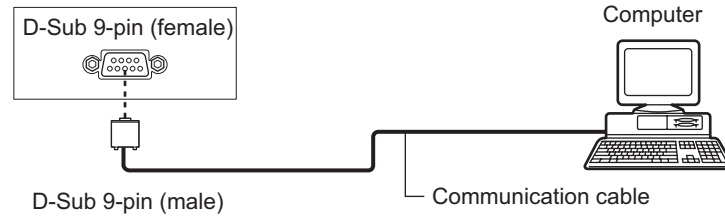

■ Pin assignments and signal names

D-Sub 9-pin (female) Outside view	Pin No.	Signal name	Details
		(1)	—
(2)		TXD	Transmitted data
(3)		RXD	Received data
(4)		—	NC
(5)		GND	Earth
(6)		—	NC
(7)		CTS	Connected internally
(8)		RTS	
(9)		—	NC

■ Communication conditions

Signal level	RS-232C-compliant
Sync. method	Asynchronous
Baud rate	9 600 bps
Parity	None

Character length	8 bits
Stop bit	1 bit
X parameter	None
S parameter	None

Technical information

Basic format

Transmission from the computer starts with STX, then the ID, command, parameter, and ETX are sent in this order. Add parameters according to the details of control.

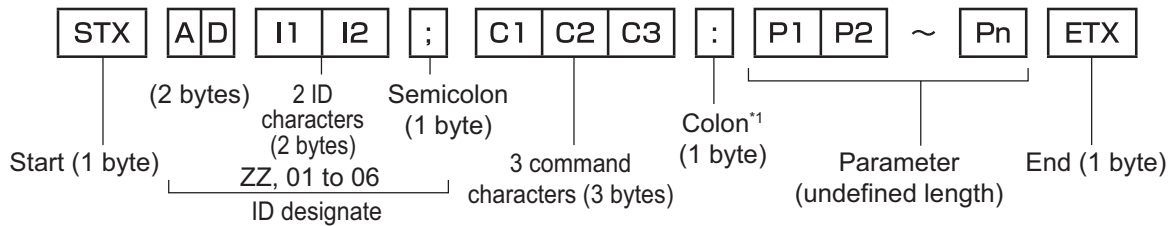

*1: When transmitting a command which does not need a parameter, a colon (:) is not necessary.

Basic format (with subcommands)

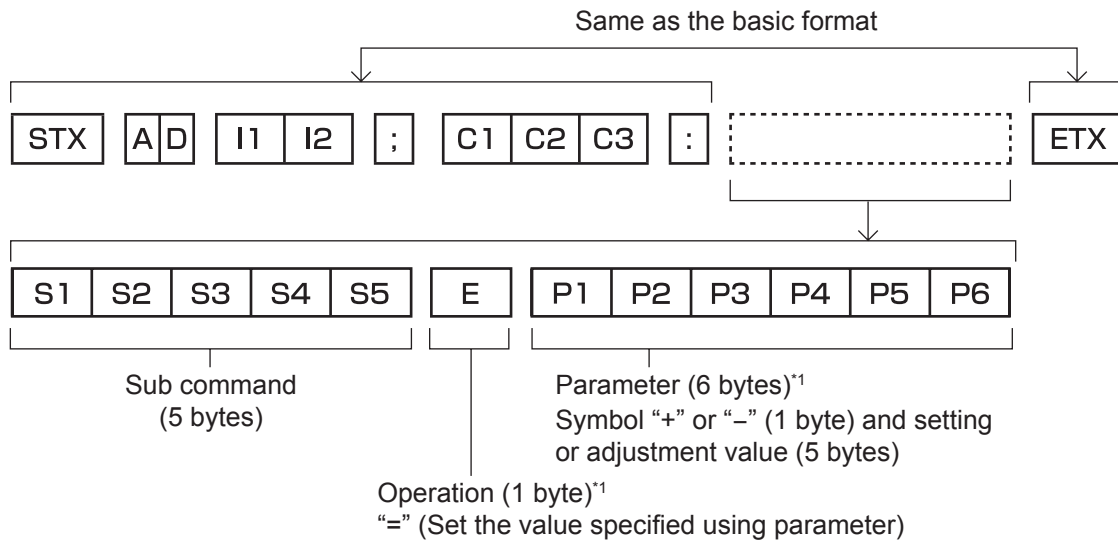

*1: When transmitting a command which does not need a parameter, the operation (E) and parameter are not necessary.

Attention

- If a command is transmitted after the lamp starts illuminating, there may be a delay in response or the command may not be executed. Try sending or receiving any command after 60 seconds.
- When transmitting multiple commands, be sure to wait until at least 0.5 seconds has elapsed after receiving the response from the projector before sending the next command.

Note

- Formats without an ID designation same as PT-F300/PT-FW300, etc. can be used.
- If the command cannot be executed, the "ER401" response is sent from the projector to the computer.
- If the wrong parameter is sent, the "ER402" response is sent from the projector to the computer.
- ID transmission in RS-232C supports ZZ (ALL) and 01 to 06.
- If a command is sent with a specified ID, a response will be sent to the computer only in the following cases.
 - It matches [PROJECTOR ID] (➡ page 64)
 - [PROJECTOR ID] (➡ page 64) of the projector is [ALL]
- STX and ETX are character codes. STX shown in hexadecimal is 02, and ETX shown in hexadecimal is 03.

■ Cable specification

● When connected to a computer

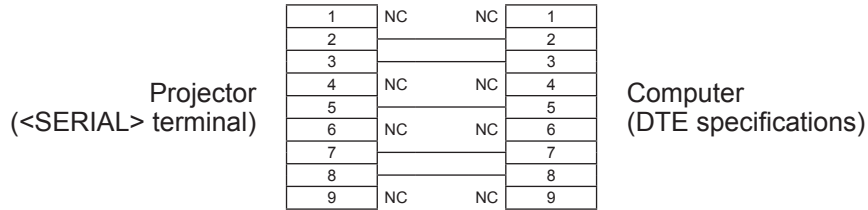

■ Control command

The following table lists the commands that can be used to control the projector using a computer.

● Projector control command

Command	Details	Notes (parameter)
PON	Power on	In the standby mode, all commands other than "PON" are invalid. During lamp On control operation, the "PON" command is not accepted.
POF	Power off	If the "PON" command is sent while the cooling fan is operating after the lamp has turned off, the lamp On control operation will start 85 seconds after the lamp has turned off, in order to protect the lamp.
AVL	Volume	(Parameter) 000 (adjustment value 0) to 063 (adjustment value 63)
IIS	Switch input modes	(Parameter) VID = VIDEO SVD = S-VIDEO RG1 = COMPUTER HD1 = HDMI 1 HD2 = HDMI 2 YUV = COMPONENT
Q\$\$	Lamp condition query	(Call back) 0 = Standby 1 = Lamp On control active 2 = Lamp On 3 = Lamp Off control active
OSH	AV Mute function	The video and sound turn off temporarily. Sending the command switches on/off. (➔ page 39) Do not switch on/off in a short period of time.

Menu lock password

To initialize your password, consult your distributor.

Technical information

List of compatible signals

The following table specifies the types of signals compatible with the projector.

Mode	Signal name	Resolution (Dots)	Scanning frequency		Dot clock Frequency (MHz)	Format ¹⁾	Plug and play	
			Horizontal (kHz)	Vertical (Hz)			Computer	HDMI
NTSC/NTSC4.43/PAL-M/PAL60	—	720 x 480i	15.7	59.9	—	V/S	—	—
PAL/PAL-N/SECAM	—	720 x 576i	15.6	50.0	—	V/S	—	—
525i (480i)	480i	720 x 480i	15.7	59.9	13.5	R/Y	—	—
625i (576i)	576i	720 x 576i	15.6	50.0	13.5	R/Y	—	—
525p (480p)	480p	720 x 483	31.5	59.9	27.0	R/Y/H	—	✓
625p (576p)	576p	720 x 576	31.3	50.0	27.0	R/Y/H	—	✓
750 (720)/60p	720/60p	1 280 x 720	45.0	60.0	74.3	R/Y/H	—	✓
750 (720)/50p	720/50p	1 280 x 720	37.5	50.0	74.3	R/Y/H	—	✓
1125 (1080)/60i	1080/60i	1 920 x 1 080i	33.8	60.0	74.3	R/Y/H	—	✓
1125 (1080)/50i	1080/50i	1 920 x 1 080i	28.1	50.0	74.3	R/Y/H	—	✓
1125 (1080)/24p	1080/24p	1 920 x 1 080	27.0	24.0	74.3	R/Y/H	—	✓
1125 (1080)/60p	1080/60p	1 920 x 1 080	67.5	60.0	148.5	R/Y/H	—	✓
1125 (1080)/50p	1080/50p	1 920 x 1 080	56.3	50.0	148.5	R/Y/H	—	✓
VESA400	VGA85	640 x 400	37.9	85.1	31.5	R	—	—
VGA	VGA70	640 x 400	31.5	70.1	25.2	R	—	—
	VGA60	640 x 480	31.5	59.9	25.2	R/H	✓	✓
	VGA67	640 x 480	35.0	66.7	30.2	R	—	—
	VGA73	640 x 480	37.9	72.8	31.5	R	—	—
	VGA75	640 x 480	37.5	75.0	31.5	R	—	—
	VGA85	640 x 480	43.3	85.0	36.0	R	—	—
SVGA	SVGA56	800 x 600	35.2	56.3	36.0	R	—	—
	SVGA60	800 x 600	37.9	60.3	40.0	R/H	✓	✓
	SVGA72	800 x 600	48.1	72.2	50.0	R	—	—
	SVGA75	800 x 600	46.9	75.0	49.5	R	—	—
	SVGA85	800 x 600	53.7	85.1	56.3	R	—	—
MAC16	MAC16	832 x 624	49.7	74.6	57.3	R	—	—
XGA	XGA50	1 024 x 768	39.6	50.0	51.9	R	—	—
	XGA60	1 024 x 768	48.4	60.0	65.0	R/H	✓	✓
	XGA70	1 024 x 768	56.5	70.1	75.0	R/H	✓	✓
	XGA75	1 024 x 768	60.0	75.0	78.8	R/H	✓	✓
	XGA85	1 024 x 768	68.7	85.0	94.5	R/H	—	—
MXGA	MXGA70	1 152 x 864	64.0	70.0	94.2	R	—	—
	MXGA75	1 152 x 864	67.5	74.9	108.0	R	—	—
	MXGA85	1 152 x 864	77.1	85.0	120.0	R	—	—
MAC21	MAC21	1 152 x 870	68.7	75.1	100.0	R	—	—
1280 x 720	1280 x 720/50	1 280 x 720	37.1	49.8	60.5	R/H	—	—
	1280 x 720/60	1 280 x 720	44.8	59.9	74.5	R/H	✓	—
1280 x 768	1280 x 768/50	1 280 x 768	39.6	49.9	65.3	R/H	—	—
	1280 x 768/60	1 280 x 768	47.8	59.9	79.5	R/H	—	—
1280 x 800	1280 x 800/50	1 280 x 800	41.3	50.0	68.0	R	—	—
	1280 x 800/60	1 280 x 800	49.7	59.8	83.5	R	✓	—

Mode	Signal name	Resolution (Dots)	Scanning frequency		Dot clock Frequency (MHz)	Format*1	Plug and play	
			Horizontal (kHz)	Vertical (Hz)			Computer	HDMI
MSXGA	MSXGA60	1 280 x 960	60.0	60.0	108.0	R	—	—
SXGA	SXGA60	1 280 x 1 024	64.0	60.0	108.0	R/H	✓	✓
	SXGA75	1 280 x 1 024	80.0	75.0	135.0	R	—	—
	SXGA85	1 280 x 1 024	91.1	85.0	157.5	R	—	—
SXGA+	SXGA+60	1 400 x 1 050	64.0	60.0	108.0	R	—	—
	SXGA+60	1 400 x 1 050	65.2	60.0	122.6	R/H	✓	✓
	SXGA+75	1 400 x 1 050	82.2	75.0	155.9	R	—	—
WXGA+	WXGA+60	1 440 x 900	55.9	59.9	106.5	R	✓	—
UXGA	UXGA60	1 600 x 1 200	75.0	60.0	162.0	R/H	✓	✓
WSXGA+	WSXGA+60	1 680 x 1 050	65.3	60.0	146.3	R	—	—
1920 x 1080	1920 x 1080/60	1 920 x 1 080 *2	66.6	59.9	138.5	R/H	✓	—
	1920 x 1080/50	1 920 x 1 080	55.6	49.9	141.5	R/H	—	—
WUXGA	WUXGA60RB	1 920 x 1 200 *2	74.0	60.0	154.0	R	—	—

*1: Abbreviation for the format means the following.

- V: Video
- S: S-video
- R: RGB
- Y: YC_BC_R/YP_BP_R
- H: HDMI

*2: VESA CVT-RB (Reduced Blanking) compatible

Note

- The number of display dots of PT-LZ370EA is 1 920 x 1 080.
A signal with a different resolution will be projected after converting the resolution to match the projector display.
- The “i” at the end of the resolution indicates an interlaced signal.
- When interlaced signals are connected, flicker may occur on the projected image.

Specifications

The following table describes the specifications of the projector.

Model No.		PT-LZ370EA		
Power supply		AC 100 V - 240 V 50 Hz/60 Hz		
Power consumption		100 V - 240 V 350 W (4.2 A - 1.5 A)		
		When [STANDBY MODE] of [ECO MANAGEMENT] is set to [ECO]: 0.08 W When [STANDBY MODE] of [ECO MANAGEMENT] is set to [NORMAL]: 7 W When [IN STANDBY MODE] of [AUDIO SETTING] is set to [ON]: 10 W		
LCD panel	Panel size	18.7 mm (0.74") (aspect ratio 16:9)		
	Display method	3 transparent LCD panels (RGB)		
	Drive method	Active matrix method		
	Pixels	2 073 600 pixels (1 920 x 1 080) x 3 panels		
Lens		Manual zoom (2x)/Manual focus F 2.0 to 3.4, f 21.5 mm to 43.0 mm		
Luminous lamp		280 W UHM lamp		
Light output*1		3 000 lm		
Applicable scanning frequency*2	For RGB signal	Horizontal: 15.6 kHz to 91.1 kHz, Vertical: 24.0 Hz to 85.1 Hz PIAS (Panasonic Intelligent Auto Scanning) system		
		Dot clock frequency 162 MHz or less		
	For YC _B Cr/YP _B P _R signal	[525i (480i)]	Horizontal 15.75 kHz	Vertical 60.0 Hz
		[525p (480p)]	Horizontal 31.5 kHz	Vertical 60.0 Hz
		[750 (720)/60p]	Horizontal 45.0 kHz	Vertical 60.0 Hz
[1125 (1080)/60i]		Horizontal 33.75 kHz	Vertical 60.0 Hz	
[1125 (1080)/60p]		Horizontal 67.5 kHz	Vertical 60.0 Hz	
[625i (576i)]	Horizontal 15.63 kHz	Vertical 50.0 Hz		
[625p (576p)]	Horizontal 31.25 kHz	Vertical 50.0 Hz		
[750 (720)/50p]	Horizontal 37.5 kHz	Vertical 50.0 Hz		
[1125 (1080)/50i]	Horizontal 28.13 kHz	Vertical 50.0 Hz		
[1125 (1080)/50p]	Horizontal 56.25 kHz	Vertical 50.0 Hz		
[1125 (1080)/24p]	Horizontal 27.0 kHz	Vertical 24.0 Hz		
● Not compatible with 3-value composite SYNC				
For video signal (including S-video)	Horizontal: 15.75 kHz/15.63 kHz, Vertical: 50.0 Hz/60.0 Hz			
For HDMI signal	525p (480p), 625p (576p), 750 (720)/60p, 750 (720)/50p, 1125 (1080)/60i, 1125 (1080)/50i, 1125 (1080)/60p, 1125 (1080)/50p, 1125 (1080)/24p ● Displayable resolution: VGA - UXGA (non-interlace) ● Dot clock frequency: 25.2 MHz to 162.0 MHz			
Color system		7 (NTSC, NTSC4.43, PAL, PAL-N, PAL-M, SECAM, PAL60)		
Projection screen size		1.02 m - 7.62 m (40" - 300")		
Screen aspect ratio		16:9		
Projection method		FRONT CEILING/FRONT DESK/REAR CEILING/REAR DESK		
Contrast ratio*1		10 000:1 (all white/all black)		

*1: Measurement, measuring conditions and method of notation all comply with ISO21118 international standards.

*2: Refer to "List of compatible signals" (➡ page 114) for the types of video signals that can be used with the projector.

Model No.		PT-LZ370EA
Terminals	<COMPUTER IN> terminal	1 set, high-density D-Sub 15 pin (female) [RGB signal] 0.7 V [p-p] 75 Ω (SYNC ON GREEN: 1.0 V [p-p] 75 Ω) SYNC/HD, TTL high impedance, automatic positive/negative polarity compatible VD, TTL high impedance, automatic positive/negative polarity compatible [YP _B PR signal] Y: 1.0 V [p-p] including synchronization signal, P _B PR: 0.7 V [p-p] 75 Ω
	<COMPONENT IN> terminal	1 set, RCA pin jack x3 Y: 1.0 V [p-p] including synchronization signal, 75 Ω P _B /C _B , P _R /C _R 0.7 V [p-p] 75 Ω
	<VIDEO IN> terminal	1 set, RCA pin jack 1.0 V [p-p] 75 Ω
	<S-VIDEO IN> terminal	1 set, Mini DIN 4 pin, Y 1.0 V [p-p], C 0.286 V [p-p] 75 Ω, S1 signal compatible
	<HDMI IN 1>/<HDMI IN 2> terminal	2 sets, HDMI 19 pin, (HDCP and Deep color compatible) Audio signal: Linear PCM (sampling frequency: 48 kHz/44.1 kHz/32 kHz)
	<SERIAL> terminal	1 set, D-Sub 9 pin, RS-232C compliant, for computer control use
	<AUDIO IN> terminal	1 set, M3 stereo mini jack, 0.5 V [rms], input impedance 22 kΩ or more
	<AUDIO OUT> terminal	1 set, M3 stereo mini jack, stereo monitor output compatible 0 V [rms] to 2.0 V [rms] variable, output impedance 2.2 kΩ or less
<LAN> terminal	1 set, RJ-45, for network connection, PLink compatible, 10Base-T/100Base-TX	
Power cable length		2.0 m (78-3/4")
Outer case		Molded plastic
Dimensions		Width: 470 mm (18-1/2"), Height: 151 mm (5-15/16") (feet at a minimum), Depth: 380 mm (14-31/32")
Weight		Approx. 8.6 kg (18.96 lbs.) *3
Operating environment		Operating environment temperature*4: 0°C (32°F) to 40°C (104°F) Operating environment humidity: 20% to 80% (no condensation)
Remote control	Power supply	DC 3 V (AA/R6/LR6 battery x 2)
	Operating range	Approx. 15 m (49'2") (when operated directly in front of the signal receiver)
	Weight	117 g (4.1 ozs.) (including batteries)
	Dimensions	Width: 48 mm (1-7/8"), Height: 163 mm (6-13/32"), Depth: 24.5 mm (31/32")

*3: Average value. Weight varies for each product.

*4: When using the projector at high elevations 1 400 m (4 593 ft) to 2 700 m (8 858 ft) sea level, temperature will be 0°C (32°F) to 35°C (95°F).

Dimensions

<Unit: mm>

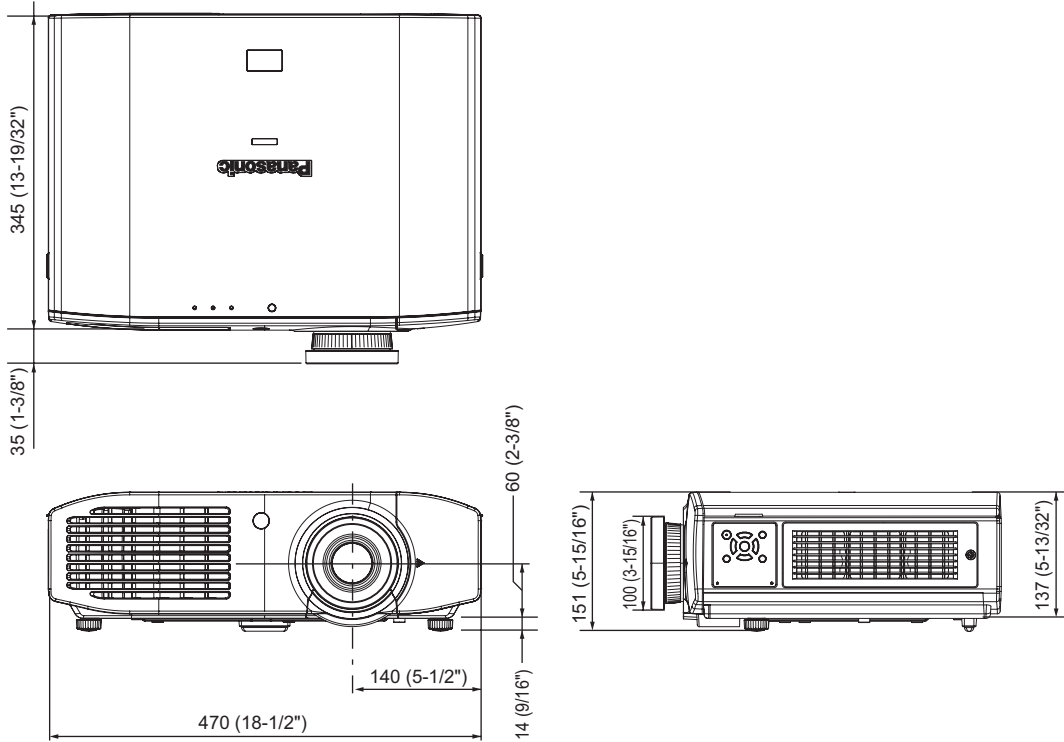

Ceiling mount bracket safeguards

- When installing the projector to a ceiling, be sure to use the specified ceiling mount bracket (ET-PKA110H: for high ceilings, ET-PKA110S: for low ceilings).
- Installation work of the ceiling mount bracket should only be performed by a qualified technician.
- Panasonic takes no responsibility for any damage to the projector resulting from use of a ceiling mount bracket not manufactured by Panasonic or the inappropriate choice of location for installation, even if the warranty period of the projector has not expired.
- An unused ceiling mount bracket must be removed promptly by a qualified technician.
- Use a torque screwdriver or Allen torque wrench to tighten bolts to their specified tightening torques. Do not use tools such as electric screwdrivers or impact screwdrivers.
- For details, read the installation manual that comes with the ceiling mount bracket.
- The part numbers of accessories and separately sold components are subject to change without notice.

Bottom view

Model No. of ceiling mount bracket: ET-PKA110H (for high ceilings)
ET-PKA110S (for low ceilings)

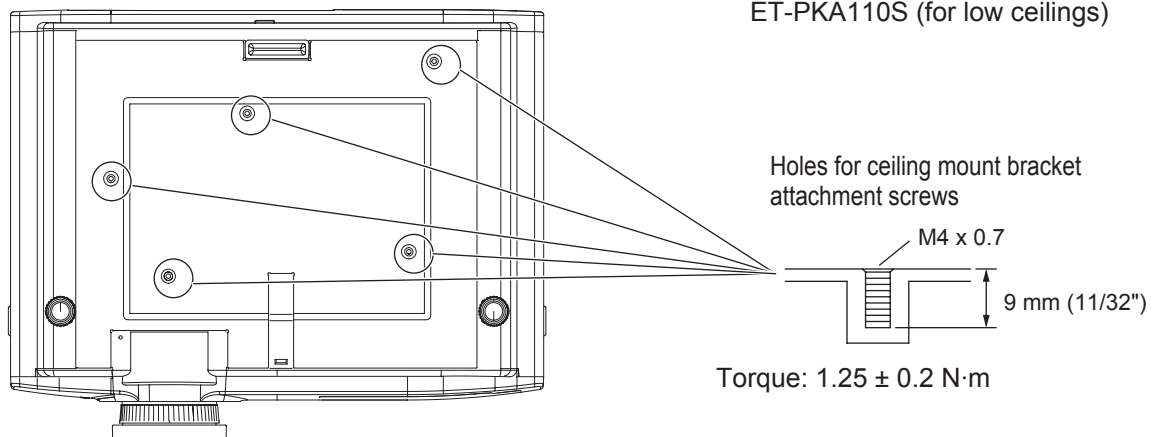

Index

A			
Accessories	16		
<AC IN> terminal	20, 33		
Adjustable feet	26		
[ADVANCED MENU]	51		
Air filter unit	97		
[ASPECT]	56		
[AUDIO SETTING]	70		
Automatic setup function	40		
[AUTO SETUP]	63		
<AUTO SETUP> button			
Remote control	19, 40		
[AUTO SETUP SETTING]	62		
<AV MUTE> button			
Remote control	39		
AV mute function	39, 63		
B			
[BACK COLOR]	63		
Before asking for repair	105		
[BRIGHTNESS]	47		
C			
Cautions on use	15		
Cautions when transporting	12		
CD-ROM	16		
Ceiling mount bracket	118		
Ceiling mount bracket safeguards	118		
[CLOCK PHASE]	55		
[CLOSED CAPTION SETTING]	61		
[COLOR]	47		
[COLOR TEMPERATURE]	47		
<COMPONENT> button			
Remote control	19, 40		
<COMPUTER> button			
Remote control	19, 40		
Connecting the power cord	33		
Connection	30		
[CONTRAST]	46		
[CONTROL DEVICE SETUP]	75		
CRESTRON RoomView	78, 93		
D			
[DATE AND TIME]	71		
[DAYLIGHT VIEW]	52		
<DEFAULT> button			
Remote control	19, 41, 43		
[DIGITAL CINEMA REALITY]	52		
Dimensions	118		
Direct power off function	36		
[DISPLAY OPTION]	45, 60		
[DISPLAY SETTING]	74		
Disposal	14		
[DOT CLOCK]	55		
[DYNAMIC IRIS]	48		
E			
<ECO> button			
Remote control	19, 41		
[ECO MANAGEMENT]	67		
Electrostatic filter	99		
[EMULATE]	69		
<ENTER> button			
Projector body	21		
Remote control	19		
F			
[FRAME LOCK]	58		
[FREEZE]	63		
<FREEZE> button			
Remote control	19, 39		
Freeze function	39		
<FUNC1> to <FUNC3> buttons			
Remote control	19, 41		
Function button	41, 69		
H			
<HDMI 1/2> button			
Remote control	19, 40		
[HDMI SIGNAL LEVEL]	61		
[HIGH ALTITUDE MODE]	65		
I			
<ID ALL> button			
Remote control	19, 22		
<ID SET> button			
Remote control	19, 22		
[INITIALIZE]	77		
[INITIALIZE ALL]	72		
Initial setting	18		
[INITIAL START UP]	65		
<INPUT SELECT> button			
Projector body	21		
Installation precautions	12		
K			
[KEYSTONE]	54		
L			
Lamp indicator	95		
[LAMP POWER]	66		
[LAMP RUNTIME]	66		
[LANGUAGE]	45, 59		
Lens shift	26		
List of compatible signals	114		
M			
Main menu	44		
Main power switch	20, 35		
Maintenance	97		
<MENU> button			
Projector body	21, 42		
Remote control	19, 42		
Menu item	44		
[MENU LOCK]	74		
[MENU LOCK PASSWORD]	75		
N			
[NAME CHANGE]	76		
Navigating through the menu	42		
[NETWORK]	45, 76		
Network connections	78		
[NETWORK CONTROL]	77		
[NOISE REDUCTION]	52		
O			
[ON-SCREEN DISPLAY]	60		
On-screen menu	42		
Optional accessories	17		
[OTHER FUNCTIONS]	63		
[OVER SCAN]	56		
P			
[PASSWORD]	73		
[PASSWORD CHANGE]	73		
[PICTURE]	44, 46		
[PICTURE MODE]	46		
[POSITION]	44, 54		
Power button			
Projector body	21		
Remote control	19		
Power cord	33		
Power indicator	34		
Precautions for use	12		
Projecting	37		
Projection method	23, 65		
Projector body	20		
[PROJECTOR ID]	64		
[PROJECTOR SETUP]	45, 64		
R			
Read this first!	2		
Remote control	19		
Remote control operations	39		
Replacing the lamp unit	100		
Replacing the unit	99		
Resetting the menu	41		
Resetting to the factory default	43		
<RETURN> button			
Projector body	21		
Remote control	19		
[RGB/YCbCr]	53		
[RGB/YpPr]	53		
RoomView	93		
RS-232C	111		
S			
[SCHEDULE]	66		
Security	14		
[SECURITY]	45, 73		
Selecting the input signal	37		
<SERIAL> terminal	111		
Setting Remote control ID numbers	22		
Setting up	23		
[SHARPNESS]	47		
[SHIFT]	54		
[SIGNAL SEARCH]	62		
Specifications	116		
[STARTUP LOGO]	62		
[STATUS]	64, 77		
Switching input signals	40		
Switching off the projector	36		
Switching on the projector	35		
[SXGA MODE]	63		
T			
Temperature indicator	96		
[TEST PATTERN]	72		
[TEXT CHANGE]	74		
[TINT]	47		
[TV-SYSTEM]	53		
V			
<VIDEO/S-VIDEO> button			
Remote control	19, 40		
<VOLUME +>/<VOLUME -> button			
Remote control	19, 41		
W			
[WAVEFORM MONITOR]	48		
[WIRED LAN]	76		

Information for Users on Collection and Disposal of Old Equipment and used Batteries



These symbols on the products, packaging, and/or accompanying documents mean that used electrical and electronic products and batteries should not be mixed with general household waste. For proper treatment, recovery and recycling of old products and used batteries, please take them to applicable collection points, in accordance with your national legislation and the Directives 2002/96/EC and 2006/66/EC.

By disposing of these products and batteries correctly, you will help to save valuable resources and prevent any potential negative effects on human health and the environment which could otherwise arise from inappropriate waste handling.



For more information about collection and recycling of old products and batteries, please contact your local municipality, your waste disposal service or the point of sale where you purchased the items.

Penalties may be applicable for incorrect disposal of this waste, in accordance with national legislation.



For business users in the European Union

If you wish to discard electrical and electronic equipment, please contact your dealer or supplier for further information.

Information on Disposal in other Countries outside the European Union

These symbols are only valid in the European Union. If you wish to discard these items, please contact your local authorities or dealer and ask for the correct method of disposal.

Note for the battery symbol (bottom two symbol examples):

This symbol might be used in combination with a chemical symbol. In this case it complies with the requirement set by the Directive for the chemical involved.