

Panasonic®

Operating Instructions

LCD Projector **Commercial Use**

Model No. **PT-LB51NTE**
PT-LB51E

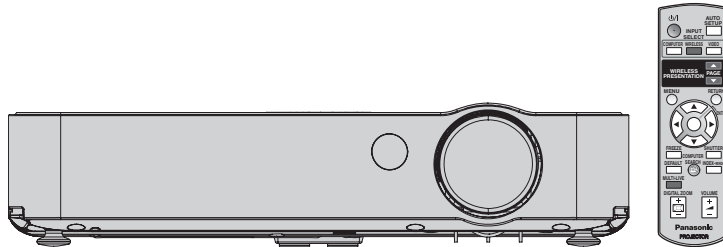

Before operating this product, please read the instructions carefully and save this manual for future use.

TQBJ0229-5

ENGLISH

Important Safety Notice

Dear Panasonic Customer:

This instruction booklet provides all the necessary operating information that you might require. We hope it will help you to get the most out of your new product, and that you will be pleased with your Panasonic LCD projector. The serial number of your product may be found on its bottom. You should note it in the space provided below and retain this booklet in case service is required.

Model number: **PT-LB51NTE/PT-LB51E**

Serial number:

WARNING: THIS APPARATUS MUST BE EARTHED.

WARNING: To prevent damage which may result in fire or shock hazard, do not expose this appliance to rain or moisture.

Machine Noise Information Ordinance 3. GSGV, January 18, 1991: The sound pressure level at the operator position is equal or less than 70 dB (A) according to ISO 7779.

WARNING:

1. Remove the plug from the mains socket when this unit is not in use for a prolonged period of time.
2. To prevent electric shock, do not remove cover. No user serviceable parts inside. Refer servicing to qualified service personnel.
3. Do not remove the earthing pin on the mains plug. This apparatus is equipped with a three prong earthing-type mains plug. This plug will only fit an earthing-type mains socket. This is a safety feature. If you are unable to insert the plug into the mains socket, contact an electrician. Do not defeat the purpose of the earthing plug.

CAUTION: To assure continued compliance, follow the attached installation instructions, which includes using the provided power cord and shielded interface cables when connecting to computer or peripheral device. If you use serial port to connect PC for external control of projector, you must use optional RS-232C serial interface cable with ferrite core. Any unauthorized changes or modifications to this equipment will void the user's authority to operate.

Pursuant to at the directive 2004/108/EC, article 9(2)
Panasonic Testing Centre
Panasonic Service Europe, a division of Panasonic Marketing Europe GmbH
Winsbergring 15, 22525 Hamburg, F.R. Germany

Information for Users on Collection and Disposal of Old Equipment and used Batteries



These symbols on the products, packaging, and/or accompanying documents mean that used electrical and electronic products and batteries should not be mixed with general household waste.

For proper treatment, recovery and recycling of old products and used batteries, please take them to applicable collection points, in accordance with your national legislation and the Directives 2002/96/EC and 2006/66/EC.

By disposing of these products and batteries correctly, you will help to save valuable resources and prevent any potential negative effects on human health and the environment which could otherwise arise from inappropriate waste handling.

For more information about collection and recycling of old products and batteries, please contact your local municipality, your waste disposal service or the point of sale where you purchased the items.

Penalties may be applicable for incorrect disposal of this waste, in accordance with national legislation.



For business users in the European Union

If you wish to discard electrical and electronic equipment, please contact your dealer or supplier for further information.

Information on Disposal in other Countries outside the European Union

These symbols are only valid in the European Union. If you wish to discard these items, please contact your local authorities or dealer and ask for the correct method of disposal.



Cd

Note for the battery symbol (bottom two symbol examples):

This symbol might be used in combination with a chemical symbol. In this case it complies with the requirement set by the Directive for the chemical involved.

Declaration of Conformity



Declaration of Conformity (DoC)

This equipment is in compliance with the essential requirements and other relevant provisions of Directive 1999/5/EC.

Customers can download a copy of the original DoC for this product from our DoC server: <http://www.doc.panasonic.de>

Contact in the EU: Panasonic Services Europe, a Division of Panasonic Marketing Europe GmbH, Panasonic Testing Centre, Winsbergring 15, 22525 Hamburg, F.R.Germany

This product is intended to be used in the following countries.

Austria, Belgium, Bulgaria, Czech, Cyprus, Denmark, Estonia, Finland, France, Germany, Greece, Hungary, Iceland, Ireland, Italy, Latvia, Lithuania, Luxembourg, Malta, Netherlands, Norway, Poland, Portugal, Romania, Slovenia, Slovak, Spain, Sweden, Switzerland & UK



Konformitätserklärung (KE)

Dieses Gerät entspricht den grundlegenden Anforderungen und den weiteren entsprechenden Vorgaben der Richtlinie 1999/5/EU.

Kunden können eine Kopie der Original-KE für dieses Produkt von unserem KE-Server herunterladen: <http://www.doc.panasonic.de>

Kontaktadresse in der EG: Panasonic Services Europe, a Division of Panasonic Marketing Europe GmbH, Panasonic Testing Centre, Winsbergring 15, 22525 Hamburg, F.R.Germany

Dieses Produkt ist für den Einsatz in den folgenden Ländern vorgesehen.

Österreich, Belgien, Bulgarien, Tschechische Republik, Zypern, Dänemark, Estland, Finnland, Frankreich, Deutschland, Griechenland, Ungarn, Island, Irland, Italien, Lettland, Litauen, Luxemburg, Malta, Niederlande, Norwegen, Polen, Portugal, Rumänien, Slowenien, Slowakei, Spanien, Schweden, Schweiz und Großbritannien



Déclaration de Conformité (DC)

Cet appareil est conforme aux exigences essentielles et aux autres dispositions pertinentes de la Directive 1999/5/EC.

Les clients peuvent télécharger une copie de la DC originale pour ce produit à partir de notre serveur DC: <http://www.doc.panasonic.de>

Coordonnées dans l'UE : Panasonic Services Europe, a Division of Panasonic Marketing Europe GmbH, Panasonic Testing Centre, Winsbergring 15, 22525 Hamburg, F.R.Germany

Ce produit est conçu pour l'utilisation dans les pays suivants.

Autriche, Belgique, Bulgarie, République Tchèque, Chypre, Danemark, Estonie, Finlande, France, Allemagne, Grèce, Hongrie, Islande, Irlande, Italie, Lettonie, Lituanie, Luxembourg, Malte, Pays-Bas, Norvège, Pologne, Portugal, Roumanie, Slovaquie, Espagne, Suède, Suisse et Royaume-Uni



Declaración de conformidad (DC)

Este equipo cumple con los requisitos esenciales así como con otras disposiciones de la Directiva 1999/5/CE.

El cliente puede descargar una copia de la DC original de este producto desde nuestro servidor DC: <http://www.doc.panasonic.de>

Contacto en la U.E.: Panasonic Services Europe, a Division of Panasonic Marketing Europe GmbH, Panasonic Testing Centre, Winsbergring 15, 22525 Hamburg, F.R.Germany

Este producto ha sido desarrollado para el uso en los siguientes países.

Austria, Bélgica, Bulgaria, República Checa, Chipre, Dinamarca, Estonia, Finlandia, Francia, Alemania, Grecia, Hungría, Islandia, Irlanda, Italia, Letonia, Lituania, Luxemburgo, Malta, Holanda, Noruega, Polonia, Portugal, Rumania, Eslovenia, Eslovaquia, España, Suecia, Suiza y el Reino Unido



Dichiarazione di conformità (DoC)

Questo apparato è conforme ai requisiti essenziali ed agli altri principi sanciti dalla Direttiva 1999/5/CE.

I clienti possono scaricare la copia del DoC originale per questo prodotto dal nostro server DoC: <http://www.doc.panasonic.de>

Contatto nella EU: Panasonic Services Europe, a Division of Panasonic Marketing Europe GmbH, Panasonic Testing Centre, Winsbergring 15, 22525 Hamburg, F.R.Germany

I prodotti sono stati prodotti per l'uso nei seguenti paesi.

Austria, Belgio, Bulgaria, Repubblica Ceca, Cipro, Danimarca, Estonia, Finlandia, Francia, Germania, Grecia, Irlanda, Islanda, Italia, Lettonia, Lituania, Lussemburgo, Malta, Olanda, Norvegia, Polonia, Portogallo, Romania, Regno Unito, Slovenia, Slovacchia, Spagna, Svezia, Svizzera, Ungheria

България

Това устройство отговаря на съществените изисквания и останалите приложими разпоредби на Директива 1999/5/ЕО.

Česky

Toto zařízení je v souladu se základními požadavky a ostatními odpovídajícími ustanoveními Směrnice 1999/5/EC.

Dansk

Dette udstyr er i overensstemmelse med de væsentlige krav og andre relevante bestemmelser i Direktiv 1999/5/EF.

Eesti

See seade vastab direktiivi 1999/5/EÜ olulistele nõuetele ja teistele asjakohastele sätetele.

Ελληνική

Αυτός ο εξοπλισμός είναι σε συμμόρφωση με τις ουσιώδεις απαιτήσεις και άλλες σχετικές διατάξεις της Οδηγίας 1999/5/ΕC.

Íslenska

Þetta tæki er samkvæmt grunnkröfum og öðrum viðeigandi ákvæðum Tilskipunar 1999/5/EC.

Latviski

Šī iekārta atbilst Direktīvas 1999/5/EK būtiskajām prasībām un citiem ar to saistītajiem noteikumiem.

Lietuvių

Šis įrenginys tenkina 1999/5/EB Direktyvos esminius reikalavimus ir kitas šios direktyvos nuostatas.

Nederlands

Dit apparaat voldoet aan de essentiële eisen en andere van toepassing zijnde bepalingen van de Richtlijn 1999/5/EC.

Malti

Dan I-apparat huwa konformi mal-ħtiġiet essenzjali u I-provedimenti I-oħra rilevanti tad-Direttiva 1999/5/EC.

Magyar

Ez a készülék teljesíti az alapvető követelményeket és más 1999/5/EK irányelvben meghatározott vonatkozó rendelkezéseket.

Norsk

Dette utstyret er i samsvar med de grunnleggende krav og andre relevante bestemmelser i EU-direktiv 1999/5/EF.

Polski

Urządzenie jest zgodne z ogólnymi wymaganiami oraz szczególnymi warunkami określonymi Dyrektywą UE: 1999/5/EC.

Português

Este equipamento está em conformidade com os requisitos essenciais e outras provisões relevantes da Directiva 1999/5/EC.

România

Acest echipament este conform cu cerințele de bază și celelalte prevederi relevante ale Directivei 1999/5/CE.

Slovensko

Ta naprava je skladna z bistvenimi zahtevami in ostalimi relevantnimi pogoji Direktive 1999/5/EC.

Slovensky

Toto zariadenie je v zhode so základnými požiadavkami a inými príslušnými nariadeniami direktív: 1999/5/EC.

Suomi

Tämä laite täyttää direktiivin 1999/5/EY olennaiset vaatimukset ja on siinä asetettujen muiden laitetta koskevien määräysten mukainen.

Svenska

Denna utrustning är i överensstämmelse med de väsentliga kraven och andra relevanta bestämmelser i Direktiv 1999/5/EC.

Contents

Quick steps

1. Set up your projector
See "Setting up" on page 16.



2. Connect with other devices
See "Connections" on page 18.



3. Prepare the Remote control
See "Remote control" on page 12.



4. Start projecting
See "Switching the projector on/off" on page 20.



5. Adjust the image
See "Projecting an image" on page 24.

Important Information

Important Safety Notice	2
Declaration of Conformity	4
Precautions with regard to safety	8
WARNINGS	8
CAUTIONS	9
Cautions when transporting	10
Cautions when installing	10
Cautions on use	11
Accessories	11

Preparation

About Your Projector	12
Remote control	12
Projector body	14

Getting Started

Setting up	16
Screen size and throw distance	16
Projection method	17
Front adjustable legs and throwing angle	17
Connections	18
Before connection to the projector	18
Connecting with computers	18
Connecting with AV equipment	19

Basic Operation

Switching the projector on/off	20
Mains lead	20
POWER indicator	21
Switching on the projector	22
Switching off the projector	23
Projecting an image	24
Selecting the input signal	24
Positioning the image	24
Remote control operation	25
Operating range	25
Setting up the image position automatically	25
Switching the input signal	26
Capturing an image	27
Stopping the projection temporary	27
Resetting to the factory default settings	27
Projecting an image in INDEX-WINDOW mode	27
Enlarging the centred area	28
Controlling the volume of the speaker	28

Settings

Menu Navigation	29
Navigating through the MENU	29
Main menu and Sub-menu	30
PICTURE menu	32
PICTURE MODE	32
CONTRAST	32
BRIGHTNESS	32
COLOR	32
TINT	32
SHARPNESS	32
COLOR TEMPERATURE	32
DAYLIGHT VIEW	33
AI	33
DETAILED SETUP	33
POSITION menu	34
REALTIME KEYSTONE	34
KEYSTONE	34
POSITION	34
DOT CLOCK	34
CLOCK PHASE	34
ASPECT	34
RESIZING	35
FRAME LOCK	35
LANGUAGE menu	35
OPTION menu	36
INPUT GUIDE	36
STARTUP LOGO	36
FUNCTION BUTTON	36
COMPUTER2 SELECT	36
LAMP POWER	36
LAMP RUNTIME	37
POWER OFF TIMER	37
DIRECT POWER ON	37
CONTROL PANEL	37
AUTO SETUP	37
SIGNAL SEARCH	37
INSTALLATION	37
HIGHLAND	38
RGB/YPBPR	38
VOLUME	38
DETAILED SETUP	38
SECURITY menu	39
INPUT PASSWORD	39
PASSWORD CHANGE	39
TEXT DISPLAY	39
TEXT CHANGE	39
WIRELESS menu (PT-LB51NTE only)	40
Items in WIRELESS menu	40

Maintenance

TEMP and LAMP Indicators	41
Managing the indicated problems	41
Care and Replacement	42
Cleaning the projector	42
Replacing the air filter	42
Replacing the Lamp unit	43
Troubleshooting	45

Appendix

Technical Information	46
List of compatible signals	46
Serial terminal	47
Computer connection guidance	49
Specifications	50
Dimensions	53
Trademark acknowledgements	53
Index	54

Precautions with regard to safety

WARNINGS

If you notice smoke, strange smells or noise coming from the projector, disconnect the mains plug from the mains socket.

- Do not continue to use the projector in such cases, otherwise fire or electric shocks could result.
- Check that no more smoke is coming out, and then contact an Authorised Service Centre for repairs.
- Do not attempt to repair the projector yourself, as this can be dangerous.

Do not install this projector in a place which is not strong enough to take the full weight of the projector.

- If the installation location is not strong enough, it may fall down or tip over, and severe injury or damage could result.

Installation work (such as ceiling suspension) should only be carried out by a qualified technician.

- If installation is not carried out correctly, there is the danger that injury or electric shocks may occur.
- Do not use other than an authorised ceiling mount bracket.

If foreign objects or water get inside the projector, or if the projector is dropped or the cabinet is broken, disconnect the mains plug from the mains socket.

- Continued use of the projector in this condition may result in fire or electric shocks.
- Contact an Authorised Service Centre for repairs.

Do not overload the mains socket.

- If the power supply is overloaded (for example, by using too many adapters), overheating may occur and fire may result.

Never attempt to modify or disassemble the projector.

- High voltages can cause fire or electric shocks.
- For any inspection, adjustment and repair work, please contact an Authorised Service Centre.

Clean the mains plug regularly to prevent it from becoming covered in dust.

- If dust builds up on the mains plug, the resulting humidity can damage the insulation, which could result in fire. Pull the mains plug out from the mains socket and wipe it with a dry cloth.
- If not using the projector for an extended period of time, pull the mains plug out from the mains socket.

Do not handle the mains plug with wet hands.

- Failure to observe this may result in electric shocks.

Insert the mains plug securely into the mains socket.

- If the plug is not inserted correctly, electric shocks or overheating could result.
- Do not use plugs which are damaged or mains sockets which are coming loose from the wall.

Do not place the projector on top of surfaces which are unstable.

- If the projector is placed on top of a surface which is sloped or unstable, it may fall down or tip over, and injury or damage could result.

Do not place the projector into water or let it become wet.

- Failure to observe this may result in fire or electric shocks.

Do not do anything that might damage the mains lead or the mains plug.

- Do not damage the mains lead, make any modifications to it, place it near any hot objects, bend it excessively, twist it, pull it, place heavy objects on top of it or wrap it into a bundle.
- If the mains lead is used while damaged, electric shocks, short-circuits or fire may result.
- Ask an Authorised Service Centre to carry out any repairs to the mains lead that might be necessary.

Do not place the projector on soft materials such as carpets or sponge mats.

- Doing so may cause the projector to overheat, which can cause burns, fire or damage to the projector.

Do not place liquid containers on top of the projector.

- If water spills onto the projector or gets inside it, fire or electric shocks could result.
- If any water gets inside the projector, contact an Authorised Service Centre.

Do not insert any foreign objects into the projector.

- Do not insert any metal objects or flammable objects into the projector or drop them onto the projector, as doing so can result in fire or electric shocks.

Do not allow the + and - terminals of the batteries to come into contact with metallic objects such as necklaces or hairpins.

- Failure to observe this may cause the batteries to leak, overheat, explode or catch fire.
- Store the batteries in a plastic bag and keep them away from metallic objects.

Do not touch the leaked liquid from the batteries.

- If you touch the leaked liquid, it may hurt your skin. Immediately wash away the liquid with water and seek medical advice.
- If you get the leaked liquid in your eye, it may cause blindness or damage. Never rub your eye, and immediately wash away the liquid with water and seek medical advice.

During a thunderstorm, do not touch the projector or the cable.

- Electric shocks can result.

Precautions with regard to safety

Do not use the projector in a bath or shower.

- Fire or electric shocks can result.

Do not place your skin into the light beam while the projector is being used.

- Strong light is emitted from the projector's lens. If you place directly into this light, it can hurt or damage your skin.

Do not look into the lens while the projector is being used.

- Strong light is emitted from the projector's lens. If you look directly into this light, it can hurt and damage your eyes.
- Be especially careful not to let young children look into the lens. In addition, turn off the power and disconnect the mains plug when you are away from the projector.

Do not place your hands or other objects close to the air outlet port.

- Heated air comes out of the air outlet port. Do not place your hands or face, or objects which cannot withstand heat close to this port [allow at least 15 cm (6") of space], otherwise burns or damage could result.

Replacement of the lamp is recommended to be carried out by a qualified technician.

- The lamp has high internal pressure. If improperly handled, explosion might result.
- The lamp can easily become damaged if struck against hard objects or dropped, and injury or malfunctions may result.

When replacing the lamp, allow it to cool for at least one hour before handling it.

- The lamp cover gets very hot, and touching it can cause burns.

Before replacing the lamp, be sure to disconnect the mains plug from the mains socket.

- Electric shocks or explosions can result if this is not done.

Do not allow infants or pets to touch the remote control unit.

- Keep the remote control unit out of the reach of infants and pets after using it.

Do not set up the projector outdoor.

- The projector is designed for indoor use only.

Dispose of unneeded power cords, cap and packaging materials appropriately after removing the product.

CAUTIONS

Do not cover the air inlet port or the air outlet port.

- Doing so may cause the projector to overheat, which can cause fire or damage to the projector.
- Do not place the projector in narrow, badly ventilated places such as closets or bookshelves.
- Do not place the projector on cloth or papers, as these materials could be drawn into the air inlet port.

Do not set up the projector in humid or dusty places or in places where the projector may come into contact with oily smoke or steam.

- Using the projector under such conditions may result in fire, electric shocks or plastic deterioration. The plastic deterioration may cause the falling down of the projector which is mounted in the ceiling.

Do not set up the projector in a high temperature environment, such as near a heater or in direct sunlight.

- Failure to observe this may result in fire, malfunction or plastic deterioration.

When disconnecting the mains lead, hold the plug, not the lead.

- If the mains lead itself is pulled, the lead will become damaged, and fire, short-circuits or serious electric shocks may result.

Always disconnect all cables before moving the projector.

- Moving the projector with cables still attached can damage the cables, which could cause fire or electric shocks to occur.

Do not place any heavy objects on top of the projector.

- Failure to observe this may cause the projector to become unbalanced and fall, which could result in damage or injury.

Do not short-circuit, heat or disassemble the batteries or place them into water or fire.

- Failure to observe this may cause the batteries to overheat, leak, explode or catch fire, and burns or other injury may result.

When inserting the batteries, make sure the polarities (+ and -) are correct.

- If the batteries are inserted incorrectly, they may explode or leak, and fire, injury or contamination of the battery compartment and surrounding area may result.

Use only the specified batteries.

- If incorrect or different kind of batteries are used, they may explode or leak, and fire, injury or contamination of the battery compartment and surrounding area may result.

Precautions with regard to safety

Do not mix old and new batteries.

- If the batteries are inserted incorrectly, they may explode or leak, and fire, injury or contamination of the battery compartment and surrounding area may result.

Remove the used batteries from the remote control promptly.

- If you leave used batteries in the remote control for an extended period of time, it may cause liquid leaking, abnormal internal temperature rising or explosion.

If not using the projector for an extended period of time, disconnect the mains plug from the mains socket and remove the batteries from the remote control.

- If dust builds up on the mains plug, the resulting humidity may damage the insulation, which could result in fire.
- Keeping or leaving the remote control with batteries inside may cause insulation deterioration, electrical leakage or explosion which could result in fire.

Do not put your weight on this projector.

- You could fall or the projector could break, and injury may result.
- Be especially careful not to let young children stand or sit on the projector.

We are constantly making efforts to preserve and maintain a clean environment. Please take non repairable units back to your dealer or a recycling company.

Disconnect the mains plug from the mains socket as a safety precaution before carrying out any cleaning.

- Electric shocks can result if this is not done.

If the lamp has broken, ventilate the room immediately. Do not touch or bring your face close to the broken pieces.

- Failure to observe this may cause the user to absorb the gas which was released when the lamp broke and which contains nearly the same amount of mercury as fluorescent lamps, and the broken pieces may cause injury.
- If you believe that you have absorbed the gas or that the gas has got into your eyes or mouth, seek medical advice immediately.
- Ask your dealer about the replacement of the lamp unit and check the inside of the projector.

Ask an Authorised Service Centre to clean inside the projector at least once a year.

- If dust is left to build up inside the projector without being cleaned out, it can result in fire or problems with operation.
- It is a good idea to clean the inside of the projector before the season for humid weather arrives. Ask your nearest Authorised Service Centre to clean the projector when required. Please discuss with the Authorised Service Centre regarding cleaning costs.

Cautions when transporting

Do not subject the projector to excessive vibration or shocks.

- The projector lens need to be handled with care.

Be sure to use the accessory carrying bag when moving the projector.

- When placing the projector inside the carrying bag, position it so that the lens is facing upward. Do not place the projector with its adjustable legs extended and do not put anything else in the bag other than the projector, cables and the remote control unit.

Cautions when installing

Avoid setting up in places which are subject to vibration or shocks.

- The internal parts can be damaged, which may cause malfunctions or accidents.

Avoid setting up in places which are subject to sudden temperature changes, such as near an air conditioner or lighting equipment.

- The life of the lamp may be shortened or the projector may be turned off. See "TEMP indicator" on page 40.

Do not set up the projector near high-voltage power lines or near motors.

- The projector may be subject to electromagnetic interference.

If installing the projector to the ceiling, ask a qualified technician to carry out all installation work.

- You will need to purchase the separate installation kit (Model No. ET-PKB50). Furthermore, all installation work is should only be carried out by a qualified technician.

If using this projector at high elevations (above 1 400 m), set the HIGHLAND to ON. See "HIGHLAND" on page 38.

- Failure to observe this may result in malfunctions or the life of the lamp or the other components may be shortened.

Cautions on use

In order to get the best picture quality

- Draw curtains or blinds over any windows and turn off any lights near the screen to prevent outside light or light from indoor lamps from shining onto the screen.

Do not touch the surfaces of the lens with your bare hands.

- If the surface of the lens becomes dirty from fingerprints or anything else, this will be magnified and projected onto the screen.

Liquid crystal panel

- Do not project the same image for long periods of time, as this may remain as an afterimage on the liquid crystal panel.
- The liquid crystal panel of the projector is built with very high precision technology to provide fine picture details. Occasionally, a few stuck pixels may appear on the screen as fixed points of blue, green or red. It is recommended to switch off the projector once and try after 1hour later again. Please note that this does not affect the performance of your LCD.

Screen

- Do not apply any volatile substances which may cause discolouration to the screen, and do not let it become dirty or damaged.

The projector has a high pressure mercury lamp and that is characterised as follows.



- The brightness of the lamp depends on the duration of use.
- The lamp may explode or shorten the lamp life by shocks or chipping damage.
- The lamp may explode only occasionally after using the projector.
- The lamp may explode if using the projector after the instructed lamp replacement timing.
- The lamp life is depends on individual lamp characteristics, usage condition and the installation environment. Especially the consecutive use of the projector for more than 10 hours, or the frequent switching on or off may greatly affect on the lamp life.

Optical components

- If you use the projector consecutively 6 hours every day, the optical components may need to be replaced in less than 1 year.

Accessories

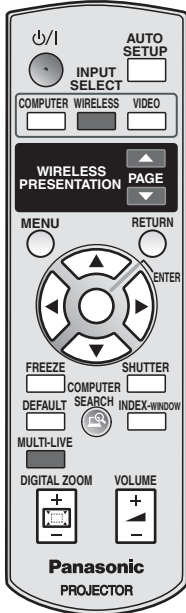
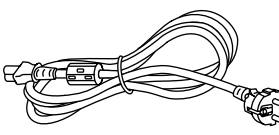
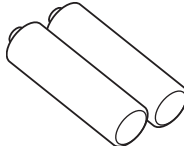
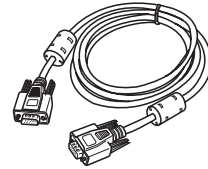
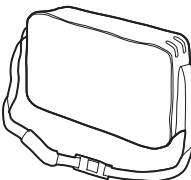
Make sure the following accessories are provided with your projector.

<p>Remote control* PT-LB51NTE : N2QAYB000169 (X1) PT-LB51E: N2QAYB000172 (X1)</p> 	<p>Mains lead (x1) TXFSX02QHUZ</p> 	<p>AA batteries for Remote control (x2)</p> 	<p>RGB signal cable (x1) [1.8 m (5' 10"), K1HA15DA0002 x1]</p> 
<p>*The illustration above is the remote control unit for the PT-LB51NTE.</p>	<p>Carrying bag (x1) (TPEP018)</p> 	<p>CD-ROM* (x1) TQBH9009</p> 	<p>*PT-LB51NTE only</p>

About Your Projector

Remote control

POWER button
Switch between stand-by mode and projection mode. (page 21)

Display the **MAIN MENU**. (page 29)

Navigate through the menus with **▲▼◀▶**, and activate the menu item with **ENTER**. (page 29)

Capture the projected image as a frozen picture. (page 26)

Reset some of the settings to the factory default settings. (page 27)

MULTI-LIVE button is only for PT-LB51NTE. ● See **CD-ROM** contents.

Control to change the scale by means of digital zoom. (page 28)

AUTO SETUP Automatically adjust the setting of **DOT CLOCK**, **CLOCK PHASE** for the projected image of **COMPUTER** signal. (page 25)

COMPUTER **INPUT SELECT** buttons
Switch the required input signal button to select.
● **WIRELESS** button is only for PT-LB51NTE.
● See **CD-ROM** contents.

PAGE buttons is only for PT-LB51NTE. ● See **CD-ROM** contents.

RETURN Return to the previous menu. (page 29)

SHUTTER Turn off the projection temporarily. (page 26)

INDEX-WINDOW Display the frozen image while the display of subsequent images continues. (page 27)

COMPUTER SEARCH button is only for PT-LB51NTE. ● See **CD-ROM** contents.

VOLUME Control to adjust the volume of the speakers. (page 28)

Battery compartment

1. Press the tab and lift up the cover.
2. Insert the batteries according to the polarity diagram indicated inside.



Top view

Remote control signal emitter. (page 25)

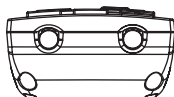

Attaching a hand strap

You can attach a favourite strap on to the **Remote control**.

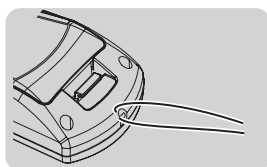

NOTE:

- Do not drop the **Remote control**.
- Avoid contact with liquids or moisture.
- Use manganese batteries or alkaline batteries with the **Remote control**.
- Do not attempt to modify or disassemble the **Remote control**. Contact an Authorised Service Centre for repairs.
- Do not keep pressing the **Remote control** buttons as this may shorten battery life.
- See "Remote control operation" on page 25.

About Your Projector

Projector body

Top and front view

Preparation

LAMP indicator (page 41)

Luminance Sensor

(page 33)

This sensor detects the luminance when the "DAYLIGHT VIEW" function is operating. Do not cover the projector and do not place any object on the projector when using it.

COMPUTER INPUT indicator

This indicator illuminates when a signal is being input to the connector (COMPUTER1 IN or COMPUTER 2 IN) selected using the **INPUT SELECT** buttons.

TEMP indicator (page 41)

Control panel

Font leg adjuster

(L) button (page 17)

These buttons are used to unlock the front adjustable legs. Press to adjust the angle of tilt of the projector.

Remote control signal receptor (page 25)

Projection lens

Zoom ring (page 24)

Focus ring (page 24)

Font leg adjuster (R) button (page 17)

Security lock

This can be used to connect a commercially-available theft-prevention cable (manufactured by Kensington). This security lock is compatible with the Microsaver Security System from Kensington.

Control panel

INPUT SELECT button (page 24)

Switch to cycle through the input method.

POWER button (page 20)

POWER indicator (page 21)

Switch between stand-by mode and projection mode.

Navigation buttons (page 29)

Navigate through the menus with **▲▼◀▶**, and activate the menu item with **ENTER**.

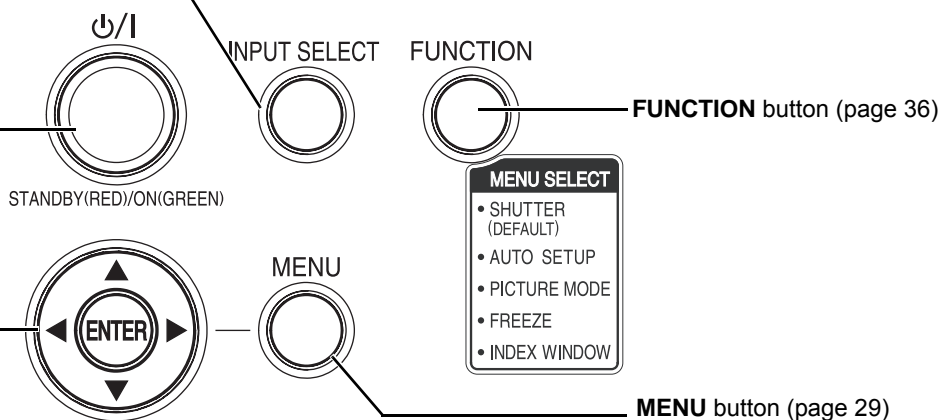

MENU button (page 29)
Display the **MAIN MENU**.

NOTE:

- Do not cover the ventilation openings or place anything within 15 cm (6") of them as this may cause damage or injury.

Back and bottom view

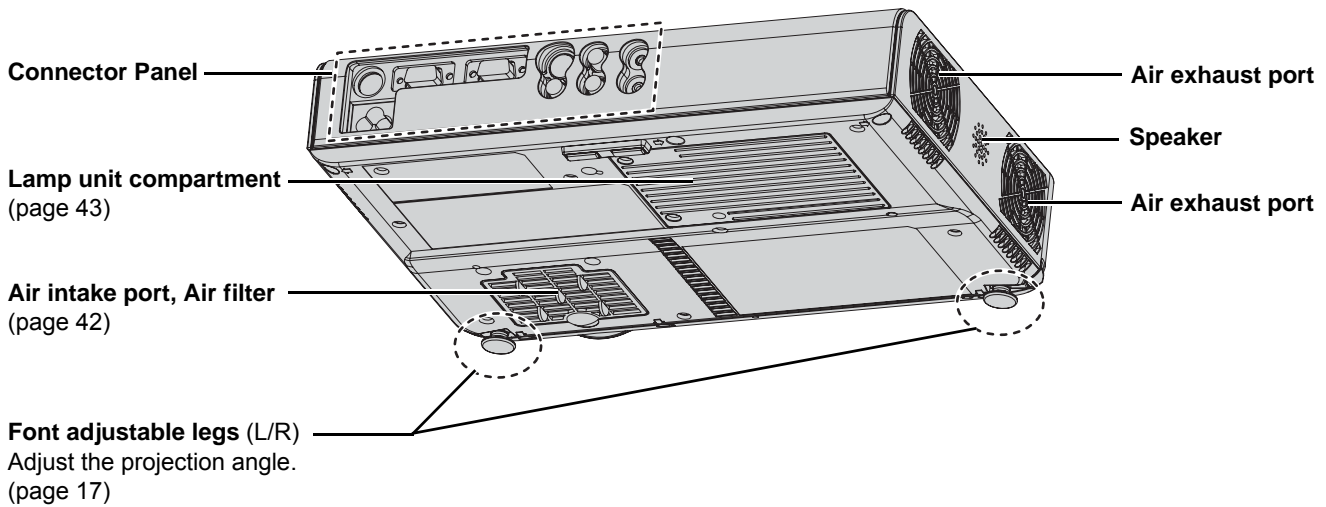

Connector Panel

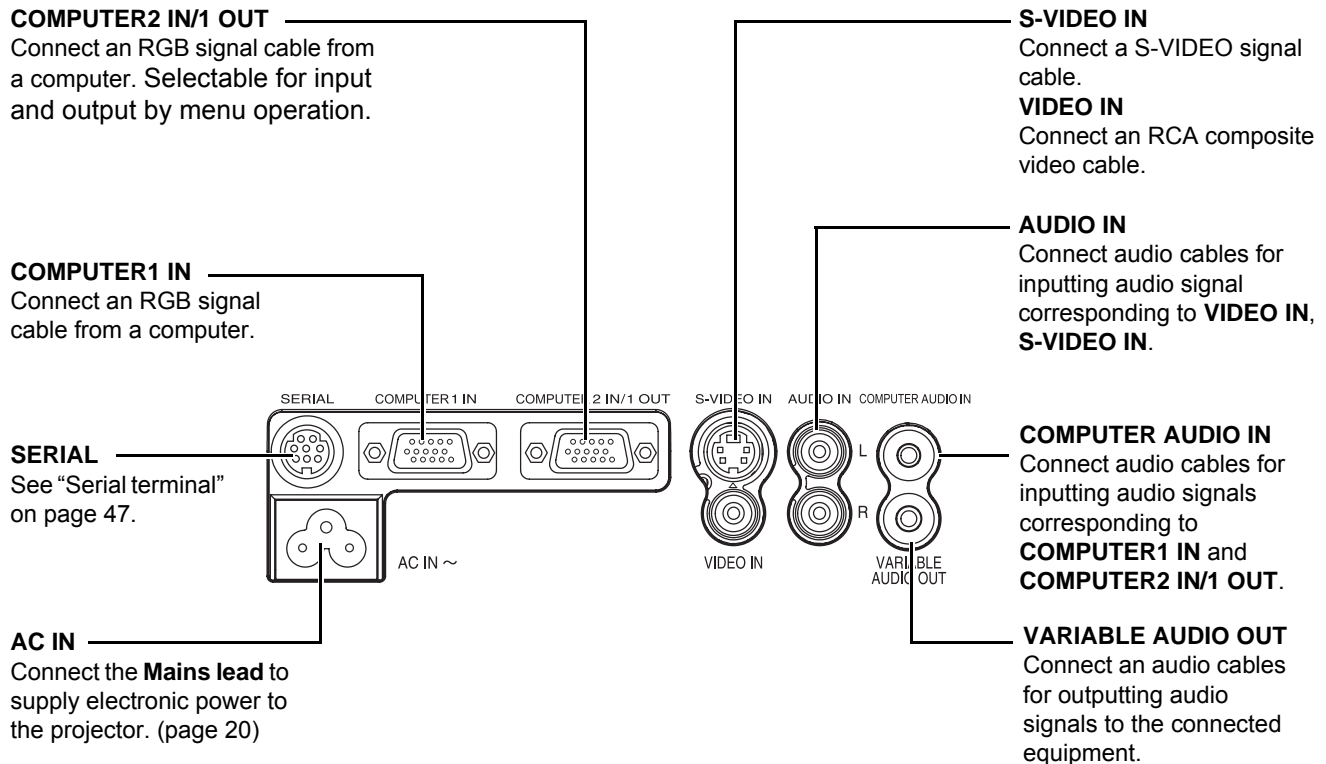

NOTE:

- Do not cover the ventilation openings or place anything within 15 cm (6") of them as this may cause damage or injury.
- When a cable is connected to the **VARIABLE AUDIO OUT**, the built-in speaker will be disabled.

Setting up

Screen size and throw distance

You can adjust the projection size with 1.2x zoom lens. Calculate and define the throw distance as follows.

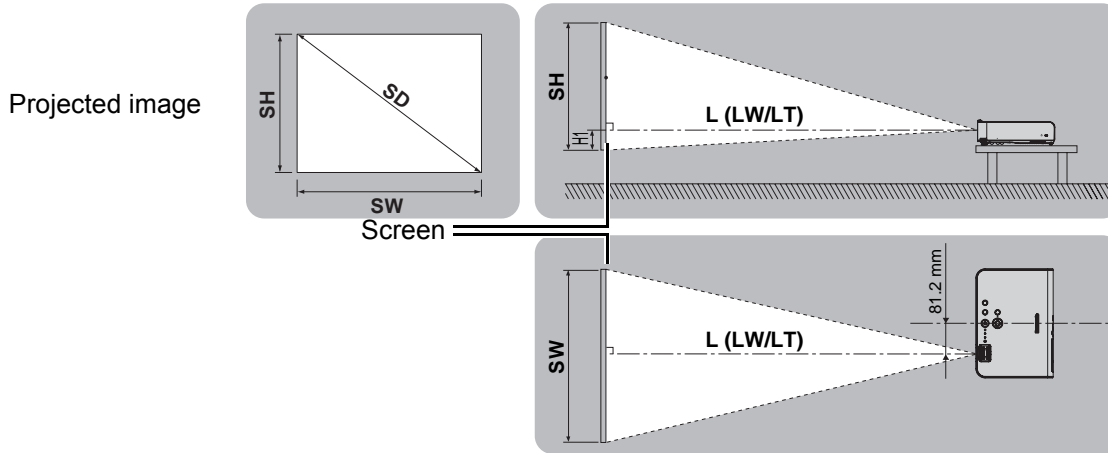

Getting Started

Projection size (4 : 3)			Throw distance (L)		Height position (H1)
Screen diagonal (SD)	Screen height (SH)	Screen width (SW)	Minimum distance (LW)	Maximum distance (LT)	
33" (0.84 m)	0.50 m (1'7")	0.67 m (2'2")		1.1 m (3'7")	0.07 m (2-3/4")
40" (1.02 m)	0.61 m (2')	0.81 m (2'7")	1.2 m (3'11")	1.4 m (4'7")	0.08 m (3-1/8")
50" (1.27 m)	0.76 m (2'5")	1.02 m (3'4")	1.6 m (5'2")	1.8 m (5'10")	0.11 m (4-5/16")
60" (1.52 m)	0.91 m (2'11")	1.22 m (4')	1.9 m (6'2")	2.1 m (6'10")	0.13 m (5-3/32")
70" (1.78 m)	1.07 m (3'06")	1.42 m (4'7")	2.2 m (7'2")	2.5 m (8'2")	0.15 m (5-7/8")
80" (2.03 m)	1.22 m (4')	1.63 m (5'4")	2.5 m (8'2")	2.9 m (9'6")	0.17 m (6-11/16")
90" (2.29 m)	1.37 m (4'5")	1.83 m (6')	2.8 m (9'2")	3.3 m (10'9")	0.19 m (7-15/32")
100" (2.54 m)	1.52 m (4'11")	2.03 m (6'7")	3.1 m (10'2")	3.6 m (11'9")	0.21 m (8-1/4")
120" (3.05 m)	1.83 m (6')	2.44 m (8')	3.7 m (12'1")	4.4 m (14'5")	0.25 m (9-13/16")
150" (3.81 m)	2.29 m (7'6")	3.05 m (10')	4.6 m (15'1")	5.5 m (18)	0.32 m (12-19/32")
200" (5.08 m)	3.05 m (10')	4.06 m (13'3")	6.2 m (20'4")	7.3 m (23'11")	0.42 m (16-17/32")
250" (6.35 m)	3.81 m (12'6")	5.08 m (16'8")	7.7 m (25'3")	9.2 m (30'2")	0.53 m (20-27/32")
300" (7.62 m)	4.57 m (14'11")	6.10 m (20')	9.2 m (30'2")	11.1 m (36'5")	0.64 m (25-3/16")

* All measurements above are approximate and may differ slightly from the actual measurements.

Calculation methods for screen dimensions

You can calculate more detailed screen dimension from the screen diagonal. (Unit: m)

● Projection size(4:3)	
SH	= SD X 0.0152
SW	= SD X 0.0203
LW	= 0.0307 X SD - 0.031
LT	= 0.0371 X SD - 0.029

● Projection size(16:9)	
SH	= SD X 0.0125
SW	= SD X 0.0221
LW	= 0.0335 X SD - 0.0315
LT	= 0.0405 X SD - 0.0365

* The results above are approximate and may differ slightly from the actual measurements.

NOTE:

- Do not use the projector at a raised or a horizontally tilted position as it may cause malfunction of the projector.
- Make sure the projector lens surface is parallel with the screen. You can tilt the projector body approximately $\pm 30^\circ$ vertically. Overtilting may result in shortening the component's life.
- For the best quality of the projection image, install a screen where sun light or room light does not shine directly onto the screen. Close window shades or curtains to block the lights.

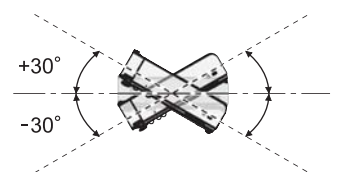

Projection method

You can use the projector with any of the following 4 projection methods. To set the desired method in the projector, See "INSTALLATION" on page 37..

■ Setting on a desk/floor and projecting from front

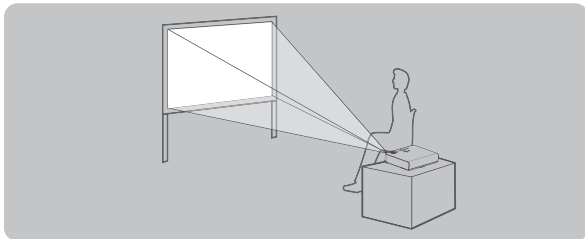

INSTALLATION: FRONT/DESK

■ Setting on a desk/floor and projecting from rear

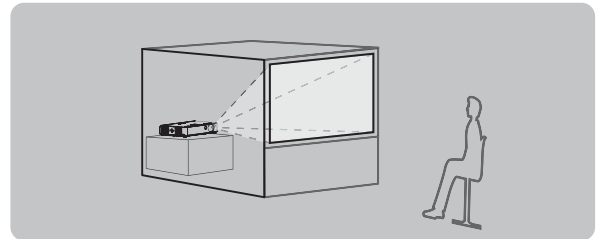

INSTALLATION: REAR/DESK

■ Mounting in the ceiling and projecting from front

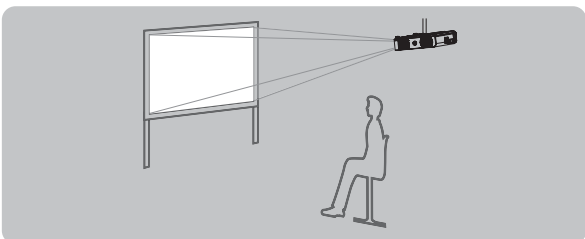

INSTALLATION: FRONT/CEILING

■ Mounting in the ceiling and projecting from rear

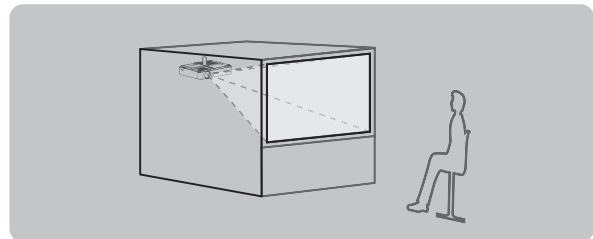

INSTALLATION: REAR/CEILING

NOTE:

- A translucent screen is required for rear projection.
- When mounting the projector in the ceiling, the optional ceiling mount bracket (ET-PKB50) is required.

Front adjustable legs and throwing angle

You can adjust the projection angle in the vertical direction by pressing the **Font leg adjuster** buttons. See "Positioning the image" on page 24.

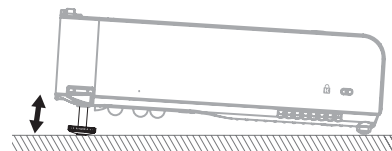
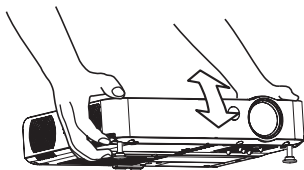

NOTE:

- Heated air comes out of the **Air exhaust port**. Be careful of this when adjusting the **Font adjustable legs**.
- If keystone distortion occurs, see "KEYSTONE" on page 34.

Connections

Before connection to the projector

- Read and follow the operating and connecting instructions of each peripheral device.
- The peripheral devices must be turned off.
- Use cables that match each peripheral device to be connected.
- If the input signal is affected by signal jitter, the projected image may have poor image quality and timebase correction is effective.
- Confirm the type of video signals. See “List of compatible signals” on page 46.
- Only one audio system circuit is available for each of the **COMPUTER AUDIO IN** and **AUDIO IN L-R** connectors, so if you change the audio input source, you will need to remove and insert the appropriate plugs.
- If the signal cables are disconnected or if the power supply for the computer or video deck is turned off while “**DIGITAL ZOOM**” or “**INDEX-WINDOW**” is being used, these functions will be cancelled.
See “Enlarging the centred area” on page 28.
See “Projecting an image in INDEX-WINDOW mode” on page 27.

Connecting with computers

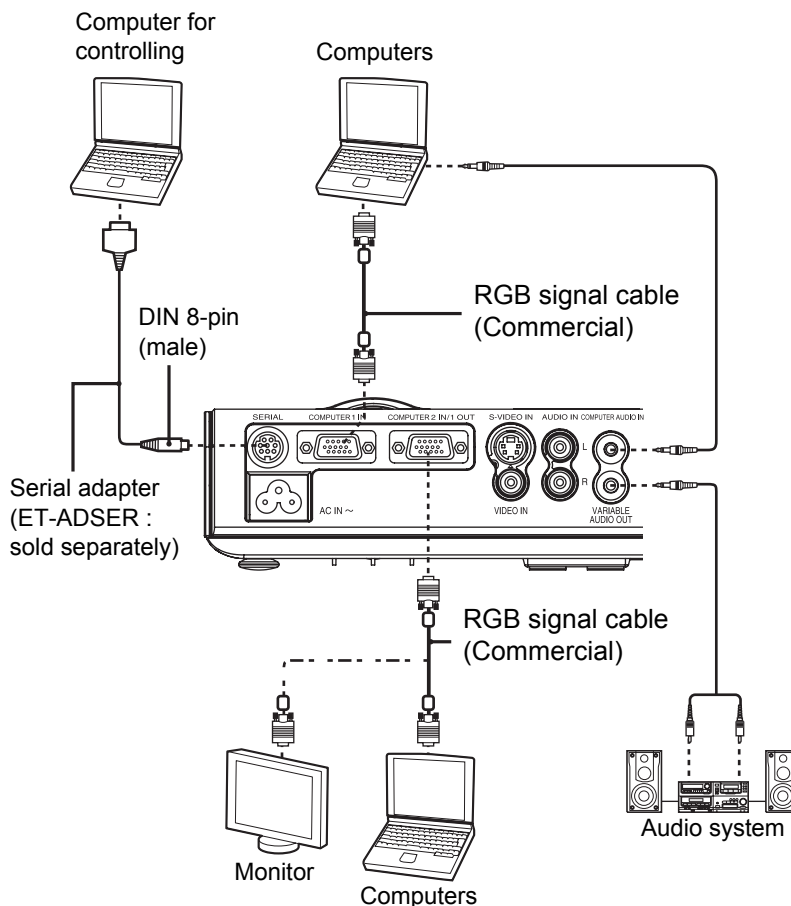

NOTE:

- When **COMPUTER2 SELECT** in the **OPTION** menu is set to **OUTPUT**, do not connect any input signals.
- Refer to the accessory CD-ROM for details on the wireless network that can be used for controlling the projector with a personal computer. (PT-LB51NTE only)

Connecting with AV equipment

Connecting with VIDEO IN/S-VIDEO IN

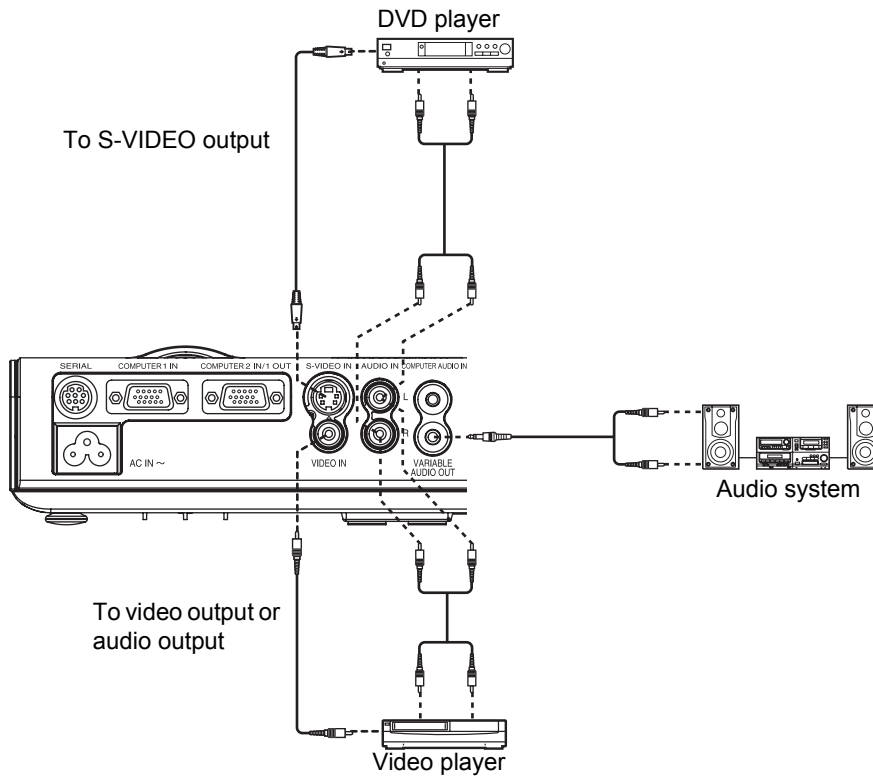

Getting Started

Connecting with COMPONENT IN

D-sub15-pin (male) - BNCx5 (male) adapter cable
 Red (connect to PR signal connector)
 Blue (connect to PB signal connector)
 Green (connect to Y signal connector)

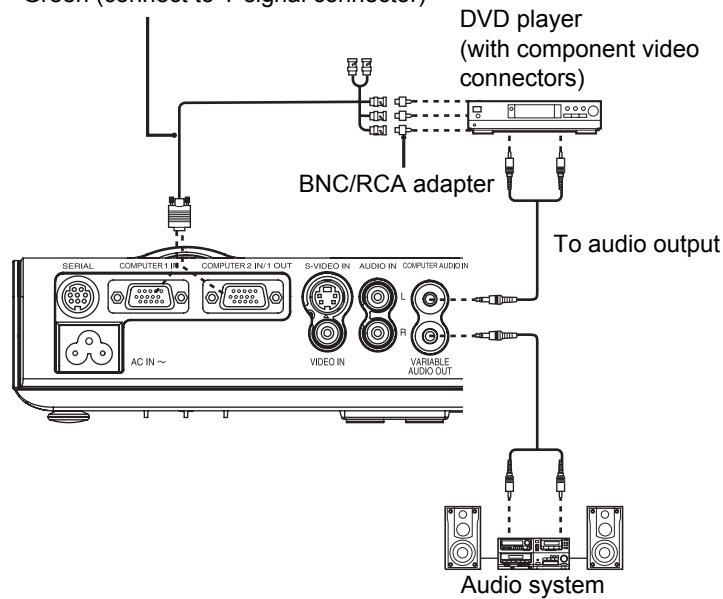

NOTE:

- If you connect the BNC cables, use with a commercial BNC-RCA adaptor.

Switching the projector on/off

Mains lead

Connecting

1. Make sure the shape of the mains plug and the **AC IN** connector on the back of the projector match, then push the plug all the way in.
2. Connect the **Mains lead** to a mains socket.

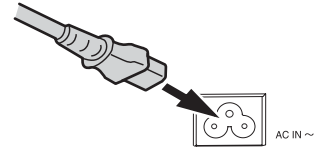

Disconnecting

1. Check that the **POWER** indicator of the **POWER** button is lit red, and then unplug the **Mains lead** from the mains socket.
2. Hold the plug and unplug the **Mains lead** from the **AC IN** connector on the back of the projector.

Direct power off function

You can disconnect the **Mains lead** during projection or immediately after use and move the projector. The cooling fan will operate by the internal power supply to cool down the lamp.

- When this function is used, it may take more time for the lamp to turn back on again compared to when the lamp cools down with the **Mains lead** connected.
- Do not put the projector in a bag while the **POWER** button on the projector is illuminated.

Direct power on function

If you activate the **DIRECT POWER ON**, you can start the projection only with connecting the **Mains lead**. See "DIRECT POWER ON" on page 37.

NOTE:

- Do not use other than a provided **Mains lead**.
- Ensure all the input devices are connected and turned off before connecting the **Mains lead**.
- Do not force the connector as this may damage the projector and/or the **Mains lead**.
- Dirt or dust build-up around plugs may cause fire or electrical hazards.
- Switch off the power to the projector when not in use.

POWER indicator

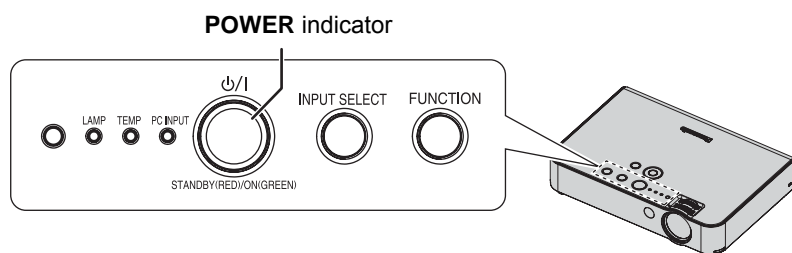

Indicator status		Status
RED	Lit	The projector is in standby. When the LAMP or TEMP indicator is flashing, the POWER indicator will not be lit.
	Flashing	The POWER is switched on and the projector is getting ready to project.
GREEN	Lit	The projector is ready to project.
	Flashing	The POWER is switched off and the projector is cooling the lamp.
ORANGE	Lit	The POWER is switched on again when cooling the lamp and recovering to projection mode. Recovery may take a while.
	Flashing	The POWER is switched on again when cooling the lamp and recovering to projection mode. Recovery may take a while.

NOTE:

- If the projector is switched on again while the internal cooling fan is still operating by the internal power supply, it may take a while to start the projection.
- The electric consumption in standby mode is 4 W.

Switching the projector on/off

Switching on the projector

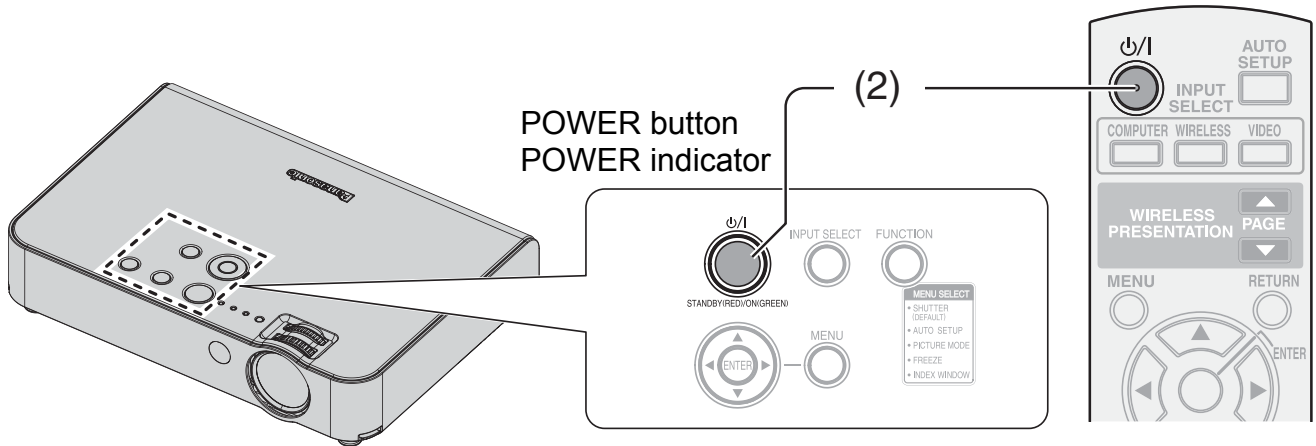

1. Plug the **Mains lead** into the projector.
 - The **POWER** indicator lights up in **RED**.
2. Press the **POWER** button.
 - The **POWER** indicator lights up in **GREEN** after flashing for a while.
 - The **STARTUP LOGO** is displayed on the screen. See "STARTUP LOGO" on page 36.

NOTE:

- Some small rattling or tinkling sound may be heard when starting up, but this is normal and does not affect the performance of the projector.
- If you disconnected the **Mains lead** while on projecting mode, the projection will start with connecting the **Mains lead**. See "DIRECT POWER ON" on page 37.

Switching off the projector

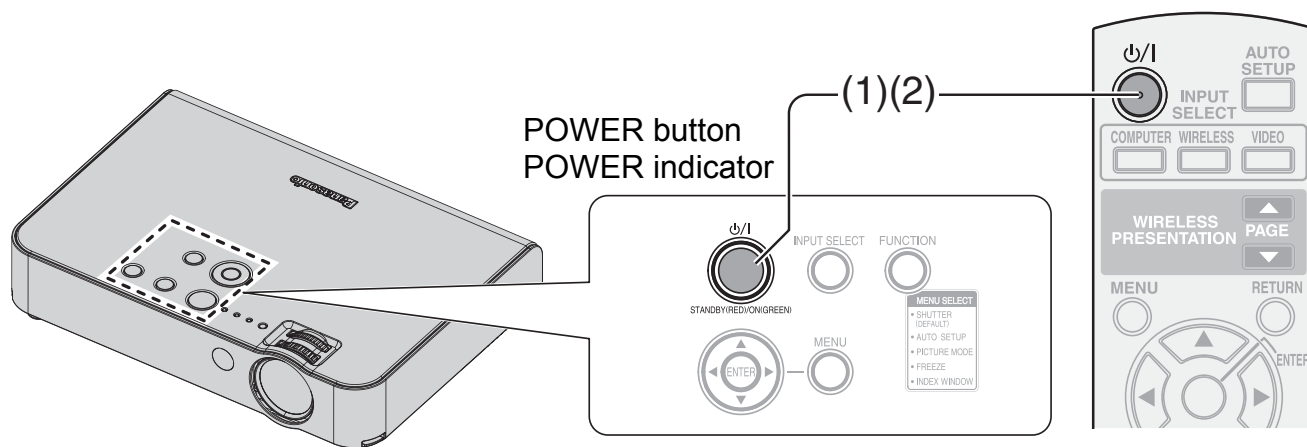

1. Press the **POWER** button.
 - The confirmation screen is displayed. It will disappear and return to the projection after 10 seconds without any operation.
 - To return to the projection, press any button except the **POWER** button.
2. Press the **POWER** button.
 - The **POWER** indicator lights up in **ORANGE** while cooling the lamp, then illuminates **RED**.
3. Once the **POWER** indicator is lit red, unplug the **Mains lead** from the projector.
 - If you are in a hurry, you can also use the direct power off function while unplugging the **Mains lead** from the projector. (page 20)

NOTE:

- Press the **POWER** twice or for a long duration to switch the power off.
- You can disconnect the **Mains lead** instead of following this procedure. See "DIRECT POWER ON" on page 37.
- You can turn off the projector by pressing the **POWER** button longer than 0.5 seconds.

Projecting an image

Selecting the input signal

1. Switch on the connected devices.
 - Press the play button of the required device.
2. Press the **INPUT SELECT** buttons to select the required input method if needed. See “Switching the input signal” on page 26.
 - The image will be projected on the screen.

NOTE:

- **SIGNAL SEARCH** is **ON** as default and the signal from the connected devices is detected automatically. See “SIGNAL SEARCH” on page 37.
- If no signal is detected, the guide screen for computer connection will be displayed (when “INPUT GUIDE” in the “OPTION” menu is set to “DETAILED”. See “INPUT GUIDE” on page 36.)
- Press the **INPUT SELECT** button to finish the input signal search.

Positioning the image

Follow the procedure below when you set the projector up first, and when you change the placement after original setup.

1. Adjusting the angle.
 - Place the projector so that it is vertical to the screen.

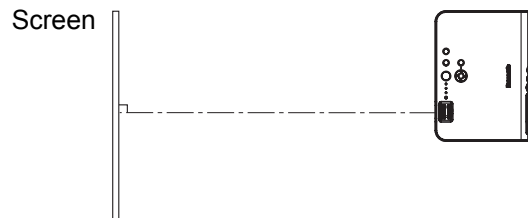

- While pressing the **Front leg adjuster** button, adjust the forward/back angle of tilt of the projector. Adjust so that the projected image is placed at the centre of the screen.
- See “Front adjustable legs and throwing angle” on page 17.

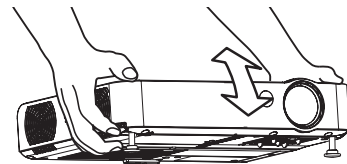

2. Press the **AUTO SETUP** button (when RGB signals are being input).
 - Settings such as the position of the image will be corrected automatically. See “Setting up the image position automatically” on page 25.

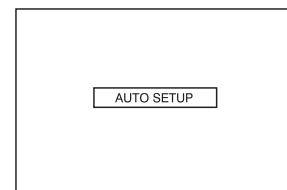

3. Adjusting the size.
 - Turn the **Zoom ring** to adjust the size of the projected image.
4. Adjusting the focus.
 - Turn the **Focus ring** to adjust the focus of the projected image.

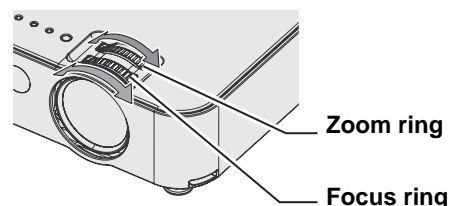

NOTE:

- Heated air comes out of the **Air exhaust port**. Be careful of this when adjusting the **Font adjustable legs**.
- If keystone distortion occurs, see “KEYSTONE” on page 34.
- If you adjust the focus, you may need to adjust the size of the image by moving the **Zoom ring** again.

Remote control operation

Operating range

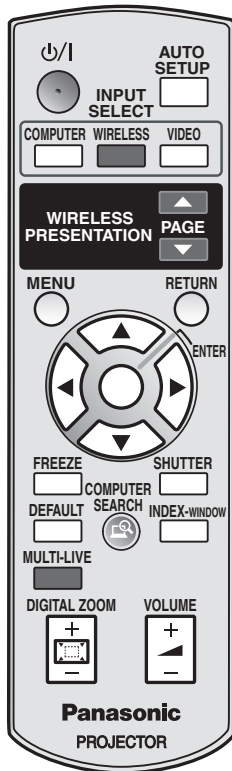

You can operate the projector with the **Remote control** within the remote range 15 m (49'2").

● Facing to the projector

Ensure the **Remote control emitter** is facing to the **Remote control signal receptor** on front of the projector and press the required buttons to operate.

● Facing to the screen

Ensure the **Remote control emitter** is facing to the screen and press the required buttons to operate the projector. The signal will be reflected off the screen. The operating range may differ due to the screen material. This function may not be effective with a translucent screen.

NOTE:

- Do not let strong light shine onto the signal receptor. The **Remote control** may malfunction under strong light such as fluorescent.
- If there are any obstacles between the **Remote control** and the **Remote control signal receptor**, the **Remote control** may not operate correctly.

Setting up the image position automatically



You can adjust the setting of the image position, **DOT CLOCK** and **CLOCK PHASE** automatically for the projected **COMPUTER** signal image.

NOTE:

- **SIGNAL SEARCH** will be adjusted only when the **SIGNAL SEARCH** is set to **ON**.
- If the dot clock frequency is 100 MHz or higher, **AUTO SETUP** is not effective.
- If the projected image is dark or blurred around the edge, **AUTO SETUP** may stop the processing before complete. Project a much clearer or lighter image and press the **AUTO SETUP** button again.
- When **FUNCTION BUTTON** is set to "AUTO SETUP" (see "FUNCTION BUTTON" on page 36), the **AUTO SETUP** operation can also be carried out by pressing the **FUNCTION** button at the front of the projector.

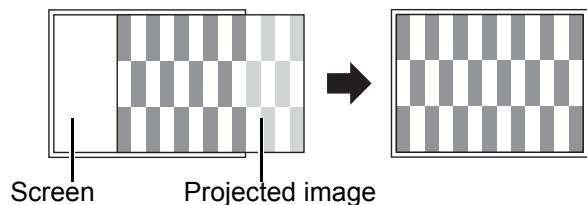

Remote control operation

Switching the input signal

COMPUTER



WIRELESS



VIDEO



You can switch the input method manually by pressing the **COMPUTER**, **WIRELESS** (PT-LB51NTE only) and **VIDEO** buttons. Press the required button several times or ◀ ▶ to cycle through the input methods as follows. The actual projected image will be changed in a while.

Pressing the COMPUTER button



NOTE:

- Only when the **COMPUTER2 SELECT** is set to **INPUT**, you can switch between **COMPUTER1** and **COMPUTER2**.

Pressing the WIRELESS button

- The **WIRELESS** button is only for PT-LB51NTE.
- See **CD-ROM** contents for more detailed information.

NOTE:

- See "List of compatible signals" on page 46.
- See "Connections" on page 18.

Capturing an image

FREEZE



When projecting an image, press **FREEZE** to capture the projected image and display it on the screen as a still picture. Press again to escape. While the image is frozen, the sound will be stopped.

Pressing the VIDEO button



Pressing the INPUT SELECT button on the projector

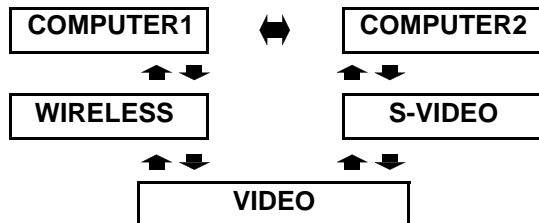

- **WIRELESS** is only for PT-LB51NTE.

Stopping the projection temporary

SHUTTER



The "SHUTTER" function can be used to momentarily turn off the picture and sound from the projector when the projector is not being used for short periods of time, such as during breaks in meetings or when carrying out preparation. The projector uses less power in "SHUTTER" mode than it does in normal projection mode.

NOTE:

- Escaping from the shutter mode is available by pressing any button.
- This operation can also be carried out using the **SHUTTER** command in the **MAIN MENU**. See "SHUTTER" on page 38.
- When **FUNCTION BUTTON** is set to "SHUTTER" (see "FUNCTION BUTTON" on page 36), the **SHUTTER** operation can also be carried out by pressing the **FUNCTION** button at the front of the projector.

Resetting to the factory default settings

DEFAULT

You can reset most of the customised settings to the factory defaults by pressing **DEFAULT** button of the **Remote control**. Display the required sub menu or the menu items and press the **DEFAULT** button again.

- See "Main menu and Sub-menu" on page 30.

NOTE:

- Some menu items are not available to reset by pressing the **DEFAULT** button. Adjust each menu items manually.

Projecting an image in INDEX-WINDOW mode

INDEX-WINDOW

You can project an image in split 2 windows as an **INDEX-WINDOW**, one is frozen, stored in memory and displayed on the screen's left side, while the display of subsequent images continues on the right.

To escape from the **INDEX-WINDOW**, press the **RETURN** button.

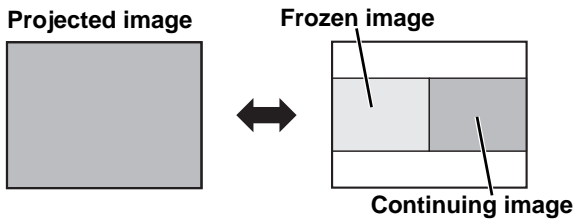

● **Switching the position**

In default, the frozen image is displayed on the left and the subsequent image is displayed on the right. Press ◀ ▶ to switch the position.

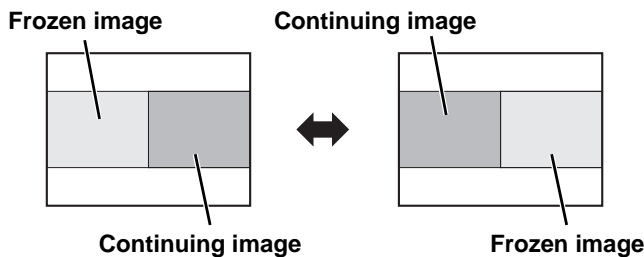

● **Changing the image size**

Press ▲ ▼ to switch and cycle through in 3 size.

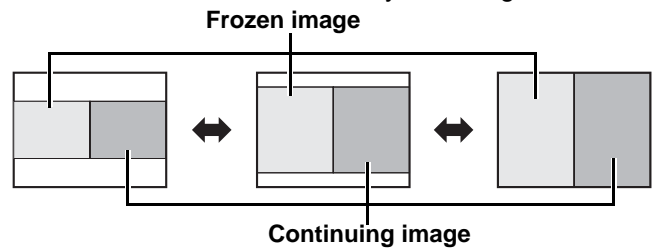

● **Capturing a new image**

While in **INDEX-WINDOW** mode, press **ENTER** to capture a new image and the frozen image window will be updated in a while.

NOTE:

- If you change the window size, the aspect ratio of the image is changed and becomes vertically elongated.
- This operation can also be carried out using the **INDEX-WINDOW** command in the **MAIN MENU**. See "INDEX-WINDOW" on page 38.
- When **FUNCTION BUTTON** is set to "INDEX WINDOW" (see "FUNCTION BUTTON" on page 36), the **INDEX-WINDOW** operation can also be carried out by pressing the **FUNCTION** button at the front of the projector.

Remote control operation

Enlarging the centred area

DIGITAL ZOOM



You can enlarge the projected image down to a centred area for emphasizing within the range of 1x to 2x.

● Enlarging the image

1. Press **DIGITAL ZOOM +/-** button once.
 - The centred area of the image will then be enlarged to 1.5x.

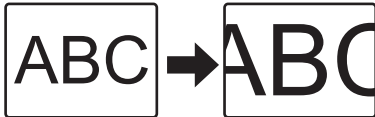

2. Adjust the image size by pressing **DIGITAL ZOOM +/-** button.
 - The image size will be changed in steps of 0.1.



● Shifting the centre point

Press **▲ ▼ ◀ ▶** to shift the centre point.

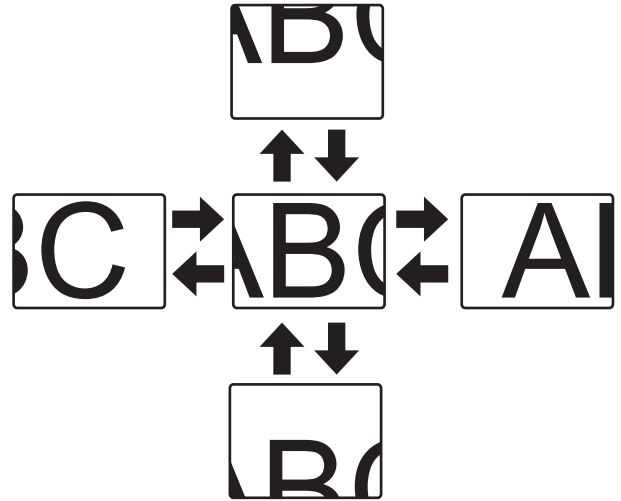

NOTE:

- When the **COMPUTER** signal is projected, the enlargement range will be changed to 1x to 3x. When the **FRAME LOCK** in **POSITION** menu is set to **ON**, the enlargement range is 1x to 2x. See "FRAME LOCK" on page 35.
- When the input signal is changed while the **DIGITAL ZOOM** is activated, the **DIGITAL ZOOM** will be cancelled.

Controlling the volume of the speaker

VOLUME



You can control the volume of the built-in speakers and output sound. Press +/- to control the volume.

NOTE:

- Power consumption can be reduced if the volume level is lowered.
- This operation can also be carried out using the **VOLUME** command in the **MAIN MENU**. See "VOLUME" on page 38.

Menu Navigation

The menu system allows you to access functions which do not have their own dedicated buttons on the **Remote control**. The menu options are structured and categorised. You can navigate through the menu with ▲ ▼ ► ◀ buttons.

Navigating through the MENU

Displaying the Main menu

MENU Press the **MENU** button to display the **Main menu** and the operating guidance.



- The illustrations of the on-screen menus in this operating instructions are for the PT-LB51NTE.

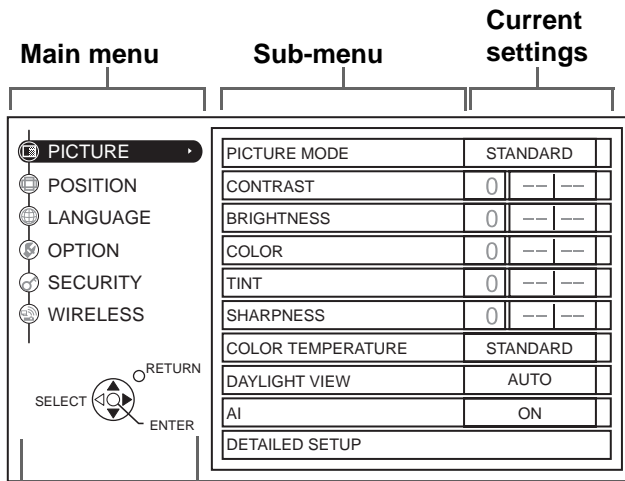

Operating guidance

Contains the required buttons to adjust the settings.

Adjusting with the bar scale items

The triangle mark under the bar indicates factory default setting and the square indicates the current setting.

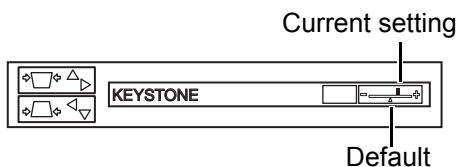

Returning to the previous menu

RETURN Press the **MENU** or **RETURN** button to return to the previous menu. Press repeatedly to escape from the menu mode and return to the projection.



Operating procedure

- Press ▲ ▼ to scroll to the required **Main menu** item and press **ENTER** to select.
 - The selected item is highlighted in orange and the **Sub-menu** is displayed on the right.
 - See “Main menu and Sub-menu” on page 30.

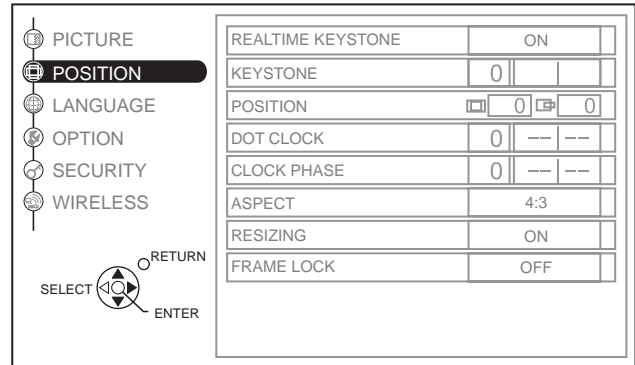

- Press ▲ ▼ to scroll to the required **Sub-menu** item and press ◀ ► or **ENTER** to adjust.
 - The selected item is called up and the other menu items disappear from the screen. Called up item will be disappear after 5 seconds and return to the menu mode.
 - If there is a lower level, the next level will be displayed.

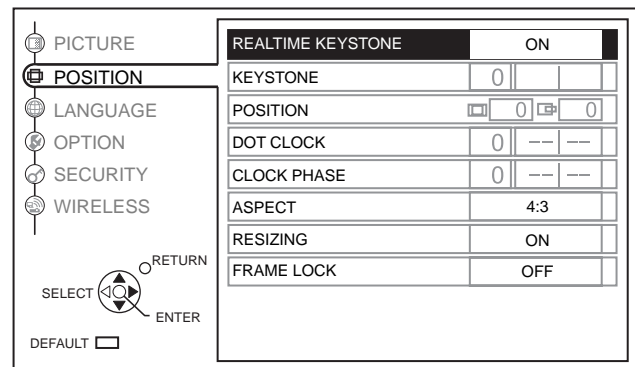

- Press ◀ ► to adjust or set the selected item.
 - For items using a bar scale, the current settings are displayed on the left of the bar scale.
 - You can cycle through the options of an item by pressing ◀ ►.



- Press **MENU** or **RETURN** to return to the previous menu.

NOTE:

- See “Resetting to the factory default settings” on page 27 to reset each menu items.





Menu Navigation

Main menu and Sub-menu

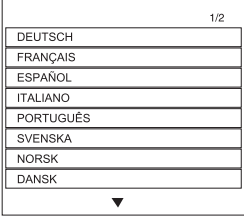

The **Main menu** has 6 options. Select the required menu item and press **ENTER** to display the **Sub-menu**.

NOTE:

- Some default settings vary by the selected input signal.
- **Sub-menu** items vary according to the selected input signal.
- Some settings are adjustable without any signals.

Main menu	Sub-menu	Options (Under line is default setting)		Page	
PICTURE 	PICTURE MODE	<u>NATURAL</u> <u>STANDARD</u>	<u>DYNAMIC</u> <u>BLACKBOARD</u>	page 32	
	CONTRAST	• Default: 0		page 32	
	BRIGHTNESS	• Default: 0		page 32	
	COLOR^{*1}	• Default: 0		page 32	
	TINT^{*1}	• Default: 0		page 32	
	SHARPNESS	• Default: 0		page 32	
	COLOR TEMPERATURE	<u>LOW</u> <u>HIGH</u>	<u>STANDARD</u>	page 32	
	DAYLIGHT VIEW	<u>AUTO</u>	<u>OFF</u>	page 33	
	AI	<u>ON</u>	<u>OFF</u>	page 33	
	DETAILED SETUP^{*2}	WHITE BALANCE (RGB signals only) • Default: 0	<u>WHITE BALANCE RED</u> <u>WHITE BALANCE GREEN</u> <u>WHITE BALANCE BLUE</u>	page 33	
TV-SYSTEM (S-VIDEO/VIDEO signals only)		<u>AUTO</u> <u>NTSC</u> <u>NTSC 4.43</u> <u>PAL</u> <u>PAL-M</u> <u>PAL-N</u> <u>SECAM</u>			
STILL MODE (S-VIDEO/VIDEO)		<u>OFF</u> <u>ON</u>			
NOISE REDUCTION (S-VIDEO/VIDEO)		<u>ON</u> <u>OFF</u>			
POSITION 	REALTIME KEYSTONE	<u>OFF</u>	<u>ON</u>	page 34	
	KEYSTONE	• Default: 0		page 34	
	POSITION^{*3}	<u>H</u>	• Default: 0		page 34
		<u>V</u>	• Default: 0		
	DOT CLOCK^{*4}	• Default: 0		page 34	
	CLOCK PHASE^{*4}	• Default: 0		page 34	
	ASPECT^{*3}	<u>4:3</u>	<u>S4:3</u>	page 34	
		<u>16:9</u>	<u>AUTO</u>		
RESIZING	<u>OFF</u>	<u>ON</u>	page 35		
FRAME LOCK^{*4}	<u>OFF</u>	<u>ON</u>	page 35		
LANGUAGE 			page 35		

*1. S-VIDEO/VIDEO/COMPONENT signals only
 *2. S-VIDEO/VIDEO/COMPUTER signals only
 *3. S-VIDEO/VIDEO/COMPUTER/COMPONENT signals only
 *4. COMPUTER/COMPONENT signals only

Main menu	Sub-menu	Options (Under line is default setting)		Page
	OPTION			
	INPUT GUIDE	<u>DETAILED</u> OFF	SIMPLE	page 36
	STARTUP LOGO	<u>ON</u>	OFF	page 36
	FUNCTION BUTTON	<u>SHUTTER</u> PICTURE MODE INDEX WINDOW	AUTO SETUP FREEZE	page 36
	COMPUTER2 SELECT	<u>INPUT</u>	OUTPUT	page 36
	LAMP POWER	<u>STANDARD</u>	ECO-MODE	page 36
	LAMP RUNTIME			page 37
	POWER OFF TIMER	<u>DISABLE</u> 15 MIN. 20 MIN. 25 MIN. 30 MIN.	35 MIN. 40 MIN. 45 MIN. 50 MIN. 55 MIN.	60 MIN. page 37
	DIRECT POWER ON	<u>OFF</u>	ON	page 37
	CONTROL PANEL	<u>VALID</u>	INVALID	page 37
	AUTO SETUP	<u>AUTO</u>	BUTTON	page 37
	SIGNAL SEARCH	<u>ON</u>	OFF	page 37
	INSTALLATION	<u>FRONT/DESK</u> FRONT/CEILING	REAR/DESK REAR/CEILING	page 37
	HIGHLAND	<u>OFF</u>	ON	page 38
	RGB/YPbPr	<u>AUTO</u> YPbPr	RGB	page 38
	VOLUME	• Default: 20		page 38
	DETAILED SETUP	<u>INDEX-WINDOW</u>		page 38
		<u>SHUTTER</u>		
		OSD DESIGN	TYPE1 TYPE3	TYPE2
		SXGA MODE	SXGA	SXGA+
	XGA MODE	XGA	WXGA	
	BLACKBOARD	<u>ON</u>	OFF	
	BACK COLOR	<u>BLUE</u>	BLACK	
	SECURITY			
	INPUT PASSWORD	<u>OFF</u>	ON	page 39
	PASSWORD CHANGE			page 39
	TEXT DISPLAY	<u>OFF</u>	ON	page 39
TEXT CHANGE			page 39	
 (PT-LB51NTE only)	WIRELESS			
	NETWORK			page 40
	NAME CHANGE			
	INPUT PASSWORD			
	PASSWORD CHANGE			
	WEB CONTROL			
	LIVE MODE CUT IN			
	STATUS			
INITIALIZE	(See CD-ROM contents for detailed information)			

PICTURE menu

Remote control

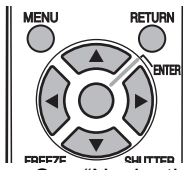

- See "Navigating through the MENU" on page 29.
- See "Main menu and Sub-menu" on page 30.

Control panel

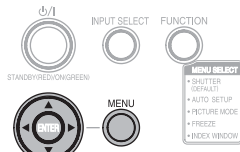

PICTURE MODE

Depending on the projection environment, you can use these preset parameter settings to optimise image projection. Press ◀ ▶ to cycle through the options.

STANDARD	Setting for a general image
DYNAMIC	Bright and sharp setting
BLACKBOARD	Setting for when projecting on a blackboard See "BLACKBOARD" on page 38.
NATURAL	Reproduces the original colour of the image

NOTE:

- It may take for a while until the selected mode is stabilised.
- When FUNCTION BUTTON is set to "PICTURE MODE" (see "FUNCTION BUTTON" on page 36), the PICTURE MODE operation can also be carried out by pressing the **FUNCTION** button at the front of the projector.

CONTRAST

You can adjust the contrast of the projected image. Adjust the **BRIGHTNESS** in advance if necessary.



BRIGHTNESS

You can adjust the brightness of the projected image.



COLOR

(S-VIDEO/VIDEO/COMPONENT signals only)
You can adjust the colour saturation of the projected image.



TINT

(NTSC/NTSC 4.43/COMPONENT signals only)
You can adjust the skin tone in the projected image.



SHARPNESS

You can adjust the sharpness of the projected image.



COLOR TEMPERATURE

You can adjust the white balance of the projected image.

- **LOW** More bluish
- **STANDARD** Balanced white
- **HIGH** More reddish

Projecting sRGBcompatible pictures

sRGB is an international colour reproduction standard (IEC61966-2-1) established by the International Electrotechnical Commission (IEC).

If you would like the colours in sRGB-compatible pictures to be reproduced more faithfully, make the following settings.

1. Press the ▲ or ▼ button to select "**PICTURE MODE**", and then press the ◀ or ▶ button to select "**NATURAL**".
2. Press the **DEFAULT** button on the remote control unit.
3. Press the ▲ or ▼ button to select "**COLOR TEMPERATURE**", and then press the ◀ or ▶ button to select "**STANDARD**".

NOTE:

- sRGB is only enabled when RGB signals are being input (when "**LAMP POWER**" is set to "**STANDARD**", "**AI**" is set to "**OFF**", and "**DAYLIGHT VIEW**" is set to "**OFF**").

DAYLIGHT VIEW

You can keep the projected image bright and vivid even in well-lit rooms where the ambient light sources cannot be controlled, such as when a door opens or when window coverings fail to block out sunlight.

- **AUTO:** Automatic adjustment
- **OFF:** Deactive

NOTE:

- Do not cover the Luminance Sensor of the projector. See "Luminance Sensor" on page 14.
- **AUTO** is not available when **INSTALLATION** setting in **OPTION** menu is set to **REAR/DESK** or **REAR/CEILING**.

AI

The lamp is controlled according to the input signals to project images with the best quality.

- **ON:** Active
- **OFF:** Deactive

NOTE:

- "AI" is disabled when "LAMP POWER" is set to "ECO-MODE". See "LAMP POWER" on page 36.

DETAILED SETUP

You can perform more detailed image adjustment manually.

For RGB signals

WHITE BALANCE

You can adjust the white balance more properly in 3 colours temperature by pressing ◀ ▶.

- **WHITE BALANCE RED**
- **WHITE BALANCE GREEN**
- **WHITE BALANCE BLUE**

For S-VIDEO/VIDEO signals

TV-SYSTEM

When the video signal is changed, the setting switches automatically. You can switch the setting manually to match the video data. Press ◀ ▶ to cycle through the options.

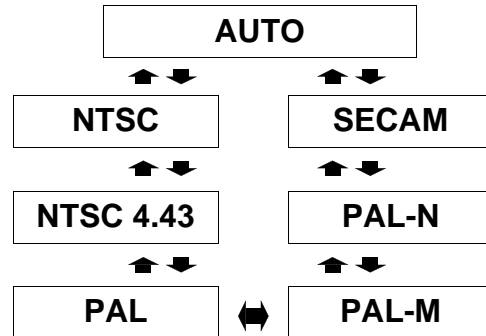

NOTE:

- **AUTO** setting will select from **NTSC/NTSC 4.43/PAL/PAL60/PAL-M/PAL-N/SECAM**.

STILL MODE

You can reduce the vertical flicker when projecting a still image.

- **OFF:** Deactive
- **ON:** Active

NOTE:

- Set to **OFF** when projecting a moving image.

NOISE REDUCTION

You can switch the automatic noise reduction system on/off. Press ◀ ▶ to select the required setting.

- **ON:** Automatic noise reduction
- **OFF:** No noise reduction

NOTE:

- Applying noise reduction may affect image quality.

POSITION menu

Remote control

- See "Navigating through the MENU" on page 29.
- See "Main menu and Sub-menu" on page 30.

Control panel

POSITION

(S-VIDEO/VIDEO/COMPUTER/COMPONENT signals only)
 You can move the projected image for fine adjustment. Press ◀ ▶ to move horizontally and ▲ ▼ vertically.

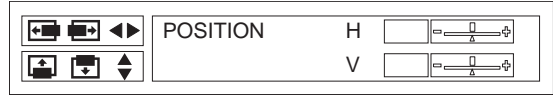

REALTIME KEYSTONE

This projector detects its own degree of tilt and corrects the keystone distortion automatically.

- **OFF:** Deactive
- **ON:** Active

KEYSTONE

This projector detects its own degree of tilt and corrects the keystone distortion automatically ("REALTIME KEYSTONE"). However, keystone distortion may still affect the images in some cases (e.g. when the projector is tilted slightly and the tilt is corrected slowly by hand or when the screen itself is tilted). In such cases, set "REALTIME KEYSTONE" to "OFF" and correct the vertical keystone distortion manually.

Image	Operation

NOTE:

- You can correct the distortion ± 30 degrees from the plane. For a better quality image, installing the projector with a minimum of distortion is recommended.
- The distortion of the **Main menu** screen is not correctable.
- The result of the keystone correction will affect the aspect ratio and the size of the image.
- You can correct the keystone distortion manually when "REALTIME KEYSTONE" is set to "ON". However, when you turn on the power, the amount of correction will be reset and "REALTIME KEYSTONE" will function again if the tilt is different from the last time you used the projector. If you correct the keystone distortion manually when "REALTIME KEYSTONE" is set to "OFF", the amount of correction will be stored by the projector even after the power is turned off.

DOT CLOCK

(COMPUTER signals only)
 If you have interference patterns of the projected image, which is sometimes referred to as moire or noise, you can minimize it by pressing ◀ ▶ to adjust the clock frequency.

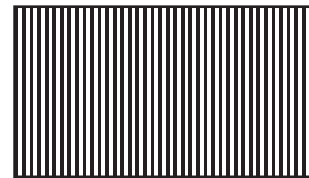

NOTE:

- If the projecting signal's dot clock frequency is higher than 100 MHz, the adjustment may not make a difference.
- **DOT CLOCK** needs to be adjusted before adjusting the **CLOCK PHASE**.

CLOCK PHASE

(COMPUTER/COMPONENT signals only)
 If you require further adjustment for the same reason as the **DOT CLOCK** adjustment, you can fine adjust the timing of the clock. Press ◀ ▶ to adjust.

NOTE:

- If the projecting signal's dot clock frequency is higher than 100 MHz, the adjustment may not make a difference.
- **CLOCK PHASE** is available with **PC** signals and the following **COMPONENT** connection.

ASPECT

(S-VIDEO/VIDEO/480i, 576i, 480p and 576p COMPONENT signals only)
 You can switch the aspect ratio manually when needed. Press ◀ ▶ to cycle through the options.

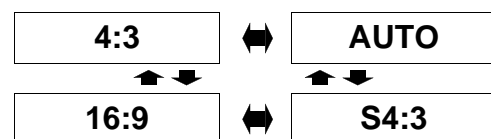

- **4:3**
The input signal will be projected without any change.

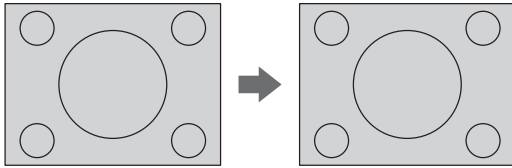

- **16:9**
The squeezed signal will be projected in 16:9 ratio.

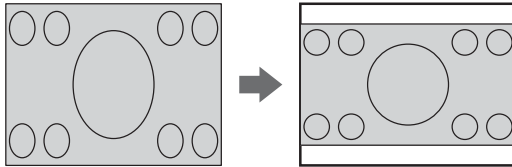

- **S4:3**
The input signal will be sized down 75 % and projected. **S4:3** mode is effective when projecting 4:3 image on to a 16:9 screen.

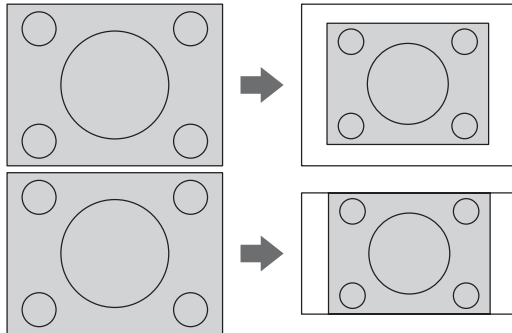

- **AUTO**
The S1 signal which contains an identifying signal will be detected and automatically project the image in proper ratio.

NOTE:

- If you project an image with an unmatched aspect ratio, the image may distort or some portions may be cropped. Select an aspect ratio which preserves the intention of the image creator.
- The order of **ASPECT** types is defined not only by the input method but also by the input signals. "List of compatible signals" on page 46
- If you project a copyrighted image enlarged or distorted by using **ASPECT** function in commercial use in a public place, such as a restaurant or hotel, you might infringe on the copyright of the creator which is protected by copyright law.

S1 video signals

- S1 video signals are a type of video signal with an aspect ratio of 16:9 which include a detector signal. This detector signal is output by some sources such as wide-vision video decks.
- When "**ASPECT**" is set to "**AUTO**", the projector recognizes the detector signal and automatically switches the aspect ratio to 16:9.

RESIZING

(**S-VIDEO/VIDEO/COMPUTER/COMPONENT** signals only)

When the input signal resolution is lower than the projector resolution, it will be projected at the projector resolution. You can deactivate the **RESIZING** and project the lower resolution input signal at its original resolution. Press ◀ ▶ to select the required setting.

- **ON** Active
- **OFF** Deactive

NOTE:

- Usually the recommended setting is **ON**.
- When the **RESIZING** is set to **ON**, the lower resolution input signal may be projected in less quality.

When the RESIZING is set to OFF;

- The size of the image will be projected smaller and you may need to adjust **ZOOM** and **FOCUS**, or the projector position backwards and forwards.
- **DIGITAL ZOOM, REALTIME KEYSTONE, KEYSTONE** and **INDEX-WINDOW** are not available.

FRAME LOCK

(**COMPUTER** signals only)

If the projected image is degraded, you can activate **FRAME LOCK** for synchronisation. Press ◀ ▶ to select the required option.

- **OFF** Deactive
- **ON** Active

LANGUAGE menu

1. Press the **MENU** button to display the menu screen.
 - Indicates the language which is currently set
2. Select the "LANGUAGE" menu from the main menu, and then press the **ENTER** button.
3. Press the ▲ or ▼ button to select a language, and then press the **ENTER** button.

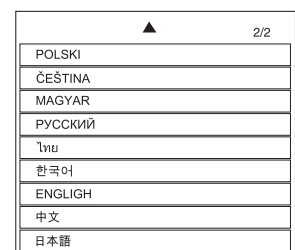
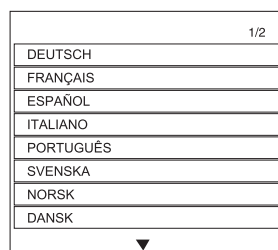

OPTION menu

Remote control

Control panel

- See “Navigating through the MENU” on page 29.
- See “Main menu and Sub-menu” on page 30.

INPUT GUIDE

When the input signal is changed, the input signal information will be displayed in the upper right corner of the projected images. You can select the level of the input signal information.

Options	Function
OFF	The input signal information will not be displayed.
SIMPLE	Only the name of the input signal will be displayed.
DETAILED	The input signal information will be displayed in detail.

NOTE:

- If “**INPUT GUIDE**” is set to “**DETAILED**”, the guide screen for computer connection will be displayed when **COMPUTER1** or **COMPUTER2** is selected and no signal is being input to the **COMPUTER1 IN** or **COMPUTER2 IN** connector. If you would like the guide screen not to be displayed, set “**INPUT GUIDE**” to “**SIMPLE**” or “**OFF**”.

STARTUP LOGO

You can switch the logo on/off that is displayed when starting up the projector. Press ◀ ▶ to select the required option.

- **ON** Active
- **OFF** Deactive

FUNCTION BUTTON

You can assign frequently-used operations to the **FUNCTION** button on the projector and use it as a convenient shortcut button. The functions which can be set are “**SHUTTER**”, “**AUTO SETUP**”, “**PICTURE MODE**”, “**FREEZE**” and “**INDEX WINDOW**”.

Use ◀ ▶ to select the function to assign to the **FUNCTION** button.

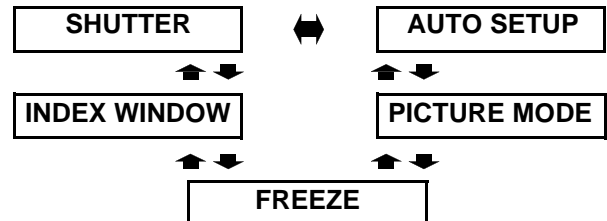

SHUTTER	Operates the shutter function See “SHUTTER” on page 38
AUTO SETUP	Starts the automatic position correction function See “AUTO SETUP” on page 37
PICTURE MODE	Switches the picture mode See “PICTURE MODE” on page 32
FREEZE	Operates the freeze function See “Capturing an image” on page 26
INDEX WINDOW	Operates the INDEX-WINDOW function See “INDEX-WINDOW” on page 38

COMPUTER2 SELECT

You can switch the function of the **COMPUTER2 IN/1 OUT** terminal.

- **INPUT** **COMPUTER2 IN**
- **OUTPUT** **COMPUTER1 OUT**

LAMP POWER

This setting changes the lamp brightness. When set to “**ECO-MODE**”, the luminance of the lamp is reduced, but the projector uses less power, and the operating noise is also reduced. This can help to extend the lamp’s operating life. If using the projector in small rooms where high luminance is not required, it is recommended that you set the “**LAMP POWER**” to “**ECO-MODE**”.

- **STANDARD** Normal mode
- **ECO-MODE** ECO mode

NOTE:

- “**LAMP POWER**” cannot be set when no signal is being input.

LAMP RUNTIME

You can check how long the lamp has been used.

NOTE:

- **LAMP RUNTIME** is a relevant matter for lamp replacement timing. See “Replacing the Lamp unit” on page 43.

POWER OFF TIMER

You can set the off timer to switch off the **POWER** of the projector after a certain period of time automatically when no signal is detected. Press ◀ ▶ to select the required period from 15 to 60 minutes at intervals of 5 minutes.

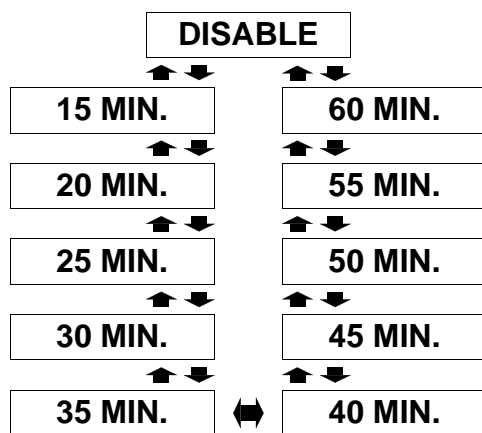

DIRECT POWER ON

You can switch the projector start up status for when the **Mains lead** is connected. Press ◀ ▶ to select the required option.

- **OFF** The projector will start from the standby mode or the projecting mode.
(The projector will start from the same status as when the mains lead was disconnected.)
- **ON** The projector will start from the projecting mode.

NOTE:

- When the projector is started from the projecting mode, pressing the **POWER** button procedure is skippable.

CONTROL PANEL

You can turn off the function of the control panel buttons on the projector body. Press ◀ ▶ to select the required option.

- **INVALID** Invalidate the control panel buttons
Confirmation screen will be displayed.
- **VALID** Validate the control panel buttons

AUTO SETUP

You can turn off the **AUTO SETUP** function for when the **COMPUTER** signal is detected.

- **AUTO** When the projector detect a **COMPUTER** signal, adjust the projected image position automatically for **SIGNAL SEARCH**, **DOT CLOCK** and **CLOCK PHASE**.
- **BUTTON** Only when the **AUTO SETUP** button is pressed, the projected image position will be adjusted for **DOT CLOCK** and **CLOCK PHASE**. See “Remote control” on page 12.

NOTE:

- Usually the recommended setting is **AUTO**.

SIGNAL SEARCH

You can turn off the auto signal detecting system.

- **ON** Detect the input signal from the terminals and project the image.
- **OFF** Deactive

NOTE:

- **SIGNAL SEARCH** is not available when any input signal is projecting.
- Usually the recommended setting is **ON**.

INSTALLATION

When installing the projector, select the projection method according to the projector position. Press ◀ ▶ to cycle through the options. See “Projection method” on page 17.

FRONT/DESK	Setting on a desk/floor and projecting from front
FRONT/CEILING	Mounting in the ceiling and projecting from front
REAR/DESK	Setting on a desk/floor and projecting from rear
REAR/CEILING	Mounting in the ceiling and projecting from rear

OPTION menu

HIGHLAND

If you use the projector at high elevation, the **HIGHLAND** setting need to be **ON** to set the fan speed high. Press ◀ ▶ to select the required option.

- **OFF** The fan speed is low.
- **ON** The fan speed is high.

NOTE:

- At 1 400 m (4 593 ft) above sea level, the setting must be **ON**.
- The loudness of fan noise depends on the **HIGHLAND** setting.

RGB/YPbPr

(480i, 576i, 480p, 576p, 1 080/60i, 1 080/50i, 720/60p and **VGA480** signals only)

This sets the signal that is input to the **COMPUTER1 IN** and **COMPUTER2 IN/1 OUT** connector.

Normally “**AUTO**” should be selected. **RGB** or **YPbPr** is selected automatically depending on the synchronising signal status.

If an image is not projected correctly, select “**RGB**” or “**YPbPr**” in accordance with the input signal.

- **AUTO** automatically
- **RGB** RGB
- **YPbPr** YPbPr

VOLUME

You can adjust the volume of the sound that is output from the projector’s built-in speaker and **VARIABLE AUDIO OUT** connector.

DETAILED SETUP

You can perform more detailed setting in various items.

INDEX-WINDOW

This functions in the same way as the **INDEX-WINDOW** button on the remote control unit. Refer to “Projecting an image in INDEX-WINDOW mode” on page 27 for details.

SHUTTER

This functions in the same way as the **SHUTTER** button on the remote control unit.

Refer to “Stopping the projection temporary” on page 26 for details.

OSD DESIGN

You can change the background colour of the menu. Press ◀ ▶ to select the required option.

TYPE1	Semi transparent black
TYPE2	Solid blue
TYPE3	Semi transparent dark blue

SXGA MODE

(**COMPUTER SXGA** signals only)

You can switch the setting between **SXGA** and the larger setting, **SXGA+**. Press ◀ ▶ to select the required option.

XGA MODE

(**COMPUTER XGA** signals only)

You can switch the setting between **XGA** and the wider setting, **WXGA**. Press ◀ ▶ to select the required option.

BLACKBOARD

You can exclude the **BLACKBOARD** in menu items of **PICTURE MODE** in **PICTURE** menu.

Press ◀ ▶ to select the required option.

- **ON** Include the **BLACKBOARD** in menu items.
- **OFF** Exclude the **BLACKBOARD** in menu items.

BACK COLOR

You can choose a **BLUE** or **BLACK** screen for when the projector is idle. Press ◀ ▶ to select the required option.

SECURITY menu

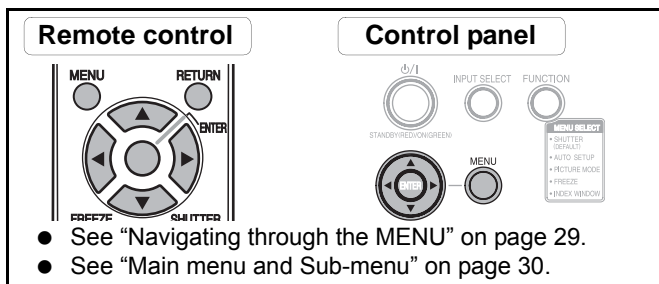

- See "Navigating through the MENU" on page 29.
- See "Main menu and Sub-menu" on page 30.

Entering the SECURITY

Every time when you apply to the **SECURITY** menu, you will be asked to perform the password operation.

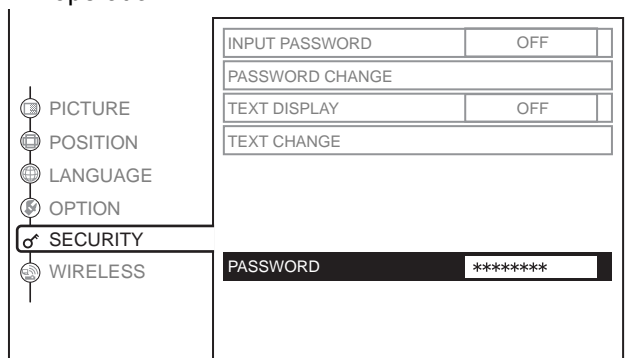

When you apply to the **SECURITY** menu before you change the password to your original, perform to input the following factory default password operation.

- Press ▲▶▼◀▲▶▼◀ and **ENTER**.

After you change the password

When you apply to the **SECURITY** menu after you change the password to your original in the **PASSWORD CHANGE** menu, input the original password operation.

NOTE:

- The factory default password is valid until you change the password in **PASSWORD CHANGE** menu.
- The entered password operations will appear as asterisks in the box.

INPUT PASSWORD

You can activate the security system and the password operation will be asked to perform when the projecting mode started. Unless you perform the correct password operation, all of the button controls will be disabled except the **POWER** button.

- **OFF** Deactive
- **ON** Active

NOTE:

- When you activated the security system, make sure to change the password to your original for safety.
- The factory default password is valid until you change the password in **PASSWORD CHANGE** menu.

PASSWORD CHANGE

You can change the password operation to your original.

1. Press a series of button operation up to 8 as a password by using ▲ ▼ ◀ ▶ buttons.
2. Press **ENTER**.
3. Press the exact same series of button operation you entered in the **NEW** password box for confirmation.
 - If a series of button operation is incorrect, you will be asked to perform again.
4. Press **ENTER**.

NOTE:

- The entered password operations will appear as asterisks in the box.

TEXT DISPLAY

You can set your original text, such as company name or URL information, to display regularly at the bottom of the projected image while projecting.

- **OFF** Deactive
- **ON** Active

TEXT CHANGE

You can enter your original text up to 22 characters for **TEXT DISPLAY**.

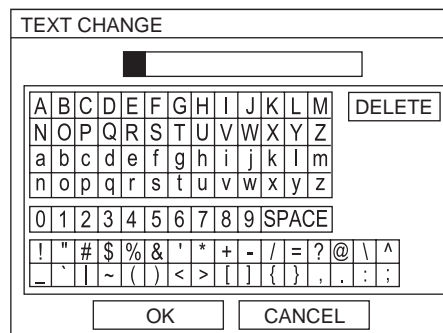

1. Use ▲ ▼ ◀ ▶ to specify the location of the required character.
2. Press **ENTER**.
 - The selected character will be displayed in the **TEXT CHANGE** box.
3. Repeat until finish your original text.
 - If you select **DELETE**, you can delete a character is selected with cursor. Then press **ENTER**.
4. Select **OK** and press **ENTER** to set the entered text.
 - Select **CANCEL** or press **MENU/RETURN** buttons to return to the previous menu.

WIRELESS menu (PT-LB51NTE only)

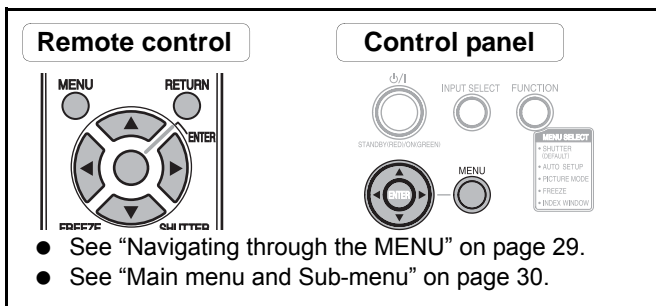

NOTE:

- See more detailed instructions in the contents of the **CD-ROM** which is provided with the projector.

Items in WIRELESS menu

In **WIRELESS** menu, the following items are available.

- **NETWORK**
Select the network setting you want to use.
- **NAME CHANGE**
The name for this projector can be set.
- **INPUT PASSWORD**
Set to “ON” if you want password confirmation to be used when controlling the projector with a personal computer by means of the wireless network.
- **PASSWORD CHANGE**
Passwords can be changed.
- **WEB CONTROL**
To control the projector with a personal computer by means of the wireless network, set the “WEBCONTROL” to “ON”.
- **LIVE MODE CUT IN**
Set to “ON” to allow users to connect to the network in LIVE mode while another user is already connected in LIVE mode.
- **STATUS**
The wireless settings will be displayed.
- **INITIALIZE**
Wireless settings can be returned to the factory default settings.

TEMP, LAMP Indicators

Managing the indicated problems

If a problem should occur with the projector, the **TEMP**, **LAMP** indicators will inform you. Manage the indicated problems as follow.

1. Confirm the status of all indicators and projector, and switch off the projector in proper way.
2. Find out the cause of the problem by status of the **TEMP**, **LAMP** indicators.
3. Follow the instruction for each indication below and solve the problem.
4. Turn on the projector in the correct way and confirm the indicator is not indicating a problem any longer.

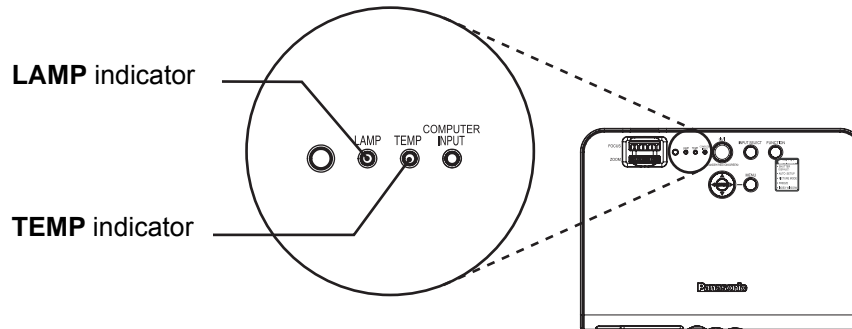

NOTE:

- If no problem is found or the problem remains, do not turn on the projector. Instead contact an Authorised Service Centre.

LAMP indicator

Indicator	● Illuminating RED	● Flashing RED
Problem	LAMP RUNTIME has reached 1 800 hours.	LAMP circuit failure, abnormal function or Lamp unit is damaged.
Cause	Lamp unit will run out soon and needs to be replaced.	The POWER is switched on again before the Lamp unit is cooled enough.
Remedy	See "Replacing the Lamp unit" on page 43.	Let the Lamp unit cool down and turn on the POWER .

TEMP indicator

Indicator	● Illuminating RED and still projecting	● Flashing RED and POWER is turned off
Problem	The temperature inside and/or outside the projector is abnormally high.	
Cause	The ventilation openings are covered.	The room temperature is too high.
Remedy	Remove the object(s) from the ventilation openings or clear around the projector.	Reinstall the t a temperature controlled place. See "Specifications" on page 50.

*1. The projector will perform only 2 minutes with **OFF** setting at high elevation.

Care and Replacement

Cleaning the projector

Before cleaning the projector

- Disconnect the mains plug from the mains socket.
- Unplug all the cables from the projector.

Cleaning the outer surface of the projector

Wipe off dirt and dust gently with a soft cloth.

- If it is difficult to remove the dirt, soak a cloth in a neutral detergent diluted with water, wring the cloth well and then wipe the projector. Dry off the projector with dry cloth.
- If you use a chemical treated wipe, follow the instructions supplied with it.

Cleaning the lens

Wipe off dirt and dust gently with a lint-free cloth.

- Make sure no dirt or dust remains on the surface of the lens. It will be enlarged and projected onto a screen.

Cleaning the air filter

If the air filter becomes clogged with dust, the internal temperature of the projector will rise, the **TEMP** indicator will illuminate and the projector's power will turn off (the **TEMP** indicator will flash after the power is turned off). **The air filter should be cleaned every 100 hours of use.**

Use a vacuum cleaner to clean off any accumulated dust.

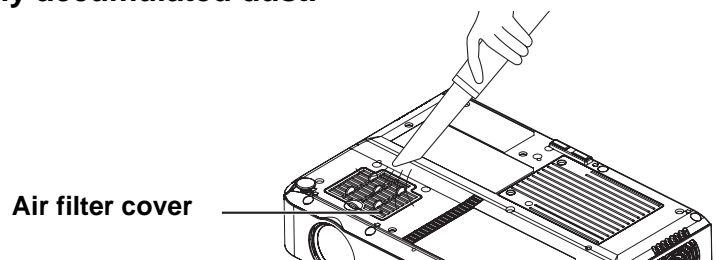

NOTE:

- If the dust cannot be cleaned by a vacuum cleaner, remove the air filter and soak it in water, and then wash out the dust by hand. Be sure to install the air filter after it has dried.
- Do not use detergent when washing the air filter.
- If the dust cannot be removed by cleaning, it is time to replace the air filter. Please consult your dealer. Furthermore, if the lamp unit is being replaced, replace the air filter at this time also.

Replacing the air filter

Before replacing the Air filter

- Disconnect the mains plug from the mains socket.

Replacement procedure

1. Gently turn the projector upside down.
2. Remove the **Air filter cover**.
3. Replace the **Air filter**, and then install the **Air filter cover**.

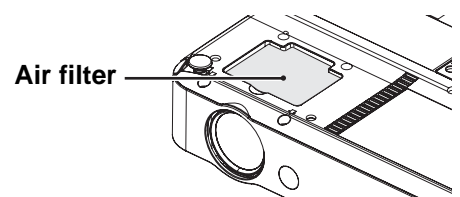
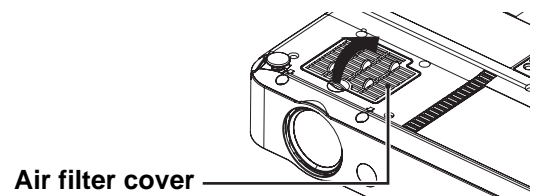

NOTE:

- Be sure to install the air filter before using the projector. If the projector is used without the air filter installed, dust and other foreign particles will be drawn into the projector, and malfunctions will result.

Replacing the Lamp unit

Before replacing the Lamp unit

- Disconnect the mains plug from the mains socket.
- Make sure the **Lamp unit** and the surroundings are cooled enough.
- Prepare a Phillips-head screwdriver.
- Contact an Authorised Service Centre to purchase a replacement **Lamp unit** (ET-LAB50).
- When the projector is mounted in the ceiling, do not work directly under the projector or put your face closer to the projector.

NOTE:



- Prior to replacing the lamp unit, allow it to cool down to prevent the risk of burns, damage and other hazards.
- Do not attempt replacement with an unauthorised lamp unit.

When to replace the Lamp unit

The **Lamp unit** is a consumable product. Even when the full life of the bulb has not been exhausted, the brightness of the light will gradually decline. Therefore periodic replacement of the lamp is necessary. The intended lamp replacement interval is 2 000 hours, but it is possible that the lamp may need to be replaced earlier due to variables such as a particular lamp's characteristics, usage conditions and the installation environment.

Early preparation for lamp replacement is encouraged.

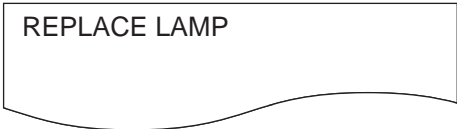
The lamp will automatically shut off after approximately 10 minutes when 2 000 hours of use have been reached because of a much greater chance of it exploding after this time.

Indication	On screen	LAMP indicator
Over 1 800 hours		
Over 2 000 hours	<p>“REPLACEMENT LAMP” is displayed on the upper left of the screen, and it will stay until you respond. To clear the screen, press any button.</p>	Illuminates RED .

NOTE:

- The usage hours explained above are for when “**LAMP POWER**” in the “**OPTION**” menu has been set to “**STANDARD**” and when “**AI**” in the “**PICTURE**” menu has been set to “**OFF**”. If “**LAMP POWER**” is set to “**ECO-MODE**”, or “**AI**” is set to “**ON**”, the life of the lamp can be extended.
- While 2 000 hours is the intended replacement interval, it is not a period of time covered by warranty.

Replacement procedure

NOTE:

- If the lamp usage time has passed 2 000 hours (when “**LAMP POWER**” has been set to “**STANDARD**” and when “**AI**” has been set to “**OFF**”), the projector will switch to standby mode after approximately 10 minutes of operation. The steps 7 to 12 should thus be completed within 10 minutes.

1. Disconnect the **Mains lead** from the projector (See “Mains lead” on page 20), and check that the area around the **Lamp unit** has cooled down.

Care and Replacement

- Use a Phillips screwdriver to turn the **lamp unit cover fixing screws** at the bottom of the projector, and then remove the **Lamp unit cover**.

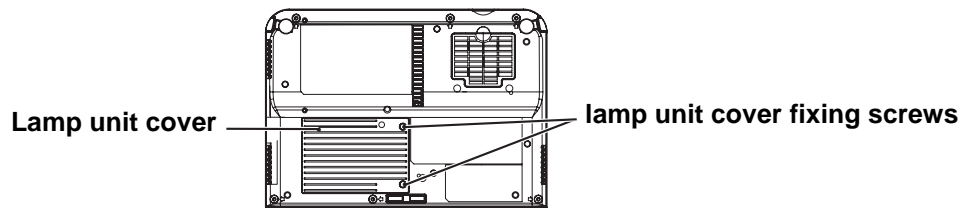

- Use a Phillips screwdriver to loosen the two **lamp unit cover fixing screws** until the screws turn freely. Then hold the handles of the **Lamp unit** and gently pull the **Lamp unit** out from the projector.

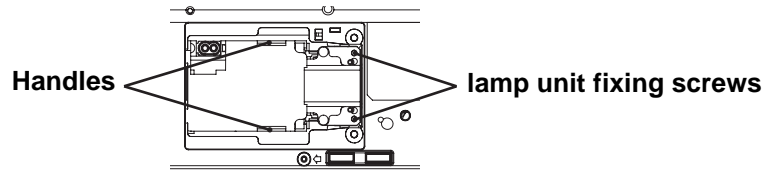

- Insert the new **Lamp unit** while making sure that the direction of insertion is correct, and then use a Phillips screwdriver to securely tighten the **lamp unit fixing screws**.

- When inserting the new **Lamp unit**, be sure to push it in at the point (A) and (B).

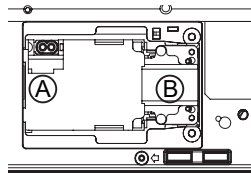

- Install the **Lamp unit cover**, and then use a Phillips screwdriver to securely tighten the **lamp unit cover fixing screws**.

NOTE:

- Be sure to install the **Lamp unit** and the **Lamp unit cover** securely. If they are not securely installed, it may cause the protection circuit to operate so that the power cannot be turned on.

- Connect the **Mains lead**.
- Press the **POWER** button so that a picture is projected onto the screen.

NOTE:

- If "**DIRECT POWER ON**" in the "**OPTION**" menu has been set to "**ON**", projection will start after the **Mains lead** is connected. See "**DIRECT POWER ON**" on page 37.

- Press the **MENU** button to display the menu screen, and then press the **▲** or **▼** button to select the "**OPTION**" menu.
- Press the **ENTER** button, and then press the **▲** or **▼** button to select "**LAMP RUNTIME**".
- Press and hold the **ENTER** button for approximately 3 seconds.
 - The "**LAMP RUNTIME**" screen will be displayed.

NOTE:

- Press any button other than the **POWER** button to cancel the "**LAMP RUNTIME**" screen.

- Press the **POWER** button to turn off the power.
- Disconnect the **Mains lead** after the **POWER** button on the projector illuminates red.
 - This will reset the cumulative usage time for the lamp unit to "0".

Troubleshooting

Should any problem persist, contact your dealer.

Problem	Cause	Reference page
Power does not turn on.	● The Mains lead may not be connected.	20
	● No electric supply is at the mains socket.	20
	● TEMP indicator is lit or flashes.	41
	● LAMP indicator is lit or flashes.	41
	● The lamp unit cover has not been securely installed.	43
	● The circuit breakers have tripped.	-
No picture appears.	● The video signal input source may not be connected to a terminal properly.	19
	● The input selection setting may not be correct.	26
	● The BRIGHTNESS adjustment setting may be at the minimum setting.	32
	● The signal input source may not be operating properly.	-
	● The SHUTTER function may be in use.	26
The picture is fuzzy.	● The lens focus may not have been set correctly.	24
	● The projector may not be at the correct distance from the screen.	16
	● The lens may be dirty.	42
	● The projector may be tilted too much.	24
The colour is pale or greyish.	● COLOR or TINT adjustment may be incorrect.	32
	● The input source which is connected to the projector may not be adjusted correctly.	30
No sound can be heard from the internal speaker.	● The audio signal source may not be connected properly.	18
	● A cable may be connected to the VARIABLE AUDIO OUT terminal.	15
	● The volume adjustment may be at the lowest possible setting.	28
The control buttons of the projector do not operate.	● CONTROL PANEL in OPTION menu is invalidated. If you have a loss of the Remote control while the CONTROL PANEL is invalidated, press and hold the MENU button for 2 seconds with pressing the ENTER button.	37
The Remote control does not operate.	● The batteries may be weak.	-
	● The batteries may not have been inserted correctly.	12
	● The Remote control signal receptor on the projector may be obstructed.	25
	● The Remote control unit may be out of the operation range.	25
	● The Remote control is under the strong light such as fluorescent.	25
The picture does not display correctly.	● The signal format (TV-SYSTEM) may not have been set correctly.	33
	● There may be a problem with the VCR or other signal source.	-
	● A signal which is not compatible with the projector is being input.	46
Picture from a computer does not appear.	● The cable may be longer than the optional cable.	-
	● The external video output from a laptop computer may not be correct. (You may be able to change the external output settings by pressing the [Fn] + [F3] or [Fn] + [F10] keys simultaneously. The actual method varies depending on the type of computer; refer to the documentation provided with your computer for further details.)	49
	● If an COMPUTER INPUT indicator is turned off, the video signals may not be output from the computer.	14
	● COMPUTER2 SELECT setting in OPTION menu is not correct.	36

Technical Information

List of compatible signals

Mode	Display resolution (dots) ^{*1}	Scanning frequency		Dot clock frequency (MHz)	Picture quality ^{*2}	Resizing ^{*3}	Terminals <signals>
		H (kHz)	V (kHz)				
NTSC/NTSC 4.43/ PAL-M/PAL60	720 x 480i	15.7	59.9		A	OK	VIDEO IN/ S-VIDEO IN <VIDEO/S-VIDEO signals>
PAL/PAL-N/SECAM	720 x 576i	15.6	50.0		A	OK	
480i	720 x 480i	15.7	59.9	13.5	A	OK	COMPUTER1 IN/ COMPUTER2 IN <COMPUTER/ COMPONENT signals>
576i	720 x 576i	15.6	50.0	13.5	A	OK	
480p	720 x 483	31.5	59.9	27.0	A	OK	
576p	720 x 576	31.3	50.0	27.0	A	OK	
1 080/60i	1 920 x 1 080i	33.8	60.0	74.3	A		
1 080/50i	1 920 x 1 080i	28.1	50.0	74.3	A		
720/60p	1 280 x 720	45.0	60.0	74.3	A		
VGA400	640 x 400	31.5	70.1	25.2	A	OK	COMPUTER1 IN/ COMPUTER2 IN <COMPUTER signals>
	640 x 400	37.9	85.1	31.5	A	OK	
VGA480 *4	640 x 480	31.5	59.9	25.2	A	OK	
	640 x 480	35.0	66.7	30.2	A	OK	
	640 x 480	37.9	72.8	31.5	A	OK	
	640 x 480	37.5	75.0	31.5	A	OK	
	640 x 480	43.3	85.0	36.0	A	OK	
SVGA	800 x 600	35.2	56.3	36.0	A	OK	
*4	800 x 600	37.9	60.3	40.0	A	OK	
	800 x 600	48.1	72.2	50.0	A	OK	
	800 x 600	46.9	75.0	49.5	A	OK	
	800 x 600	53.7	85.1	56.3	A	OK	
MAC16	832 x 624	49.7	74.6	57.3	A	OK	
XGA *4	1 024 x 768	48.4	60.0	65.0	AA		
	1 024 x 768	56.5	70.1	75.0	AA		
	1 024 x 768	60.0	75.0	78.8	AA		
	1 024 x 768	68.7	85.0	94.5	AA		
	1 024 x 768i	35.5	87.0	44.9	AA		
MXGA	1 152 x 864	64.0	71.2	94.2	A		
	1 152 x 864	67.5	74.9	108.0	B		
	1 152 x 864	76.7	85.0	121.5	B		
MAC21	1 152 x 870	68.7	75.1	100	B		
MSXGA *4	1 280 x 960	60.0	60.0	108.0	B		
SXGA *4	1 280 x 1 024	64.0	60.0	108.0	B		
	1 280 x 1 024	80.0	75.0	135.0	B		
	1 280 x 1 024	91.1	85.0	157.5	B		
SXGA+ *4	1 400 x 1 050	64.0	60.0	108.0	B		
*4	1 400 x 1 050	65.1	59.9	122.4	B		
UXGA60 *4	1 600 x 1 200	75.0	60.0	162.0	B		
WXGA ^{*5} *4	1 280 x 768	47.8	59.9	79.5	A		
*4	1 280 x 800	49.7	59.8	83.5	A		
*4	1 440 x 900	55.9	59.9	106.5	A		

*1. The "i" appearing after the resolution indicates an interlaced signal.

*2. The following symbols are used to indicate picture quality.

AA Maximum picture quality can be obtained.

A Signals are converted by the image processing circuit before picture is projected.

B Some loss of data occurs to make projection easier.

*3. Signals with "OK" are compatible with the "RESIZING" function. See "RESIZING" on page 35.

*4. Signals that are compatible with the "FRAME LOCK" function. See "FRAME LOCK" on page 35.

*5. Signals that are compatible with the CVT standard.

Serial terminal

The serial connector which is on the connector panel of the projector conforms to the RS-232C interface specification, so that the projector can be controlled by a personal computer which is connected to this connector.

Connection

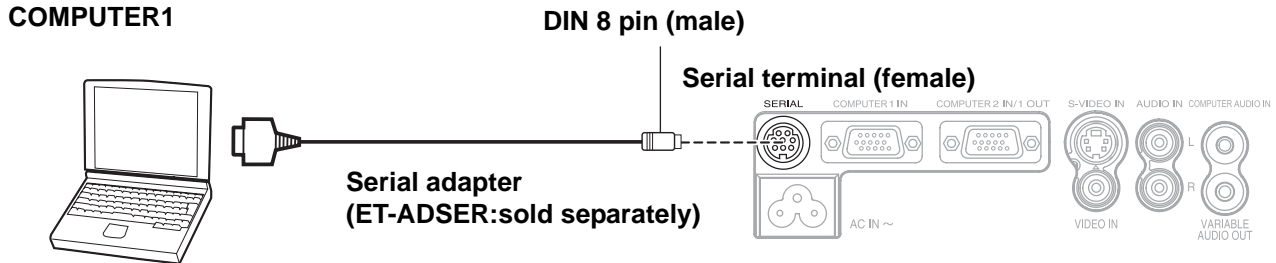

Pin assignments and signal names

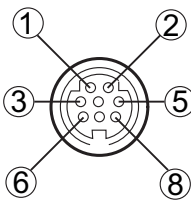
	Pin No.	Signal name	Contents
		① ② ⑥	
	③	RXD	Received data
	④	GND	Earth
	⑤	TXD	Transmitted data
	⑦ ⑧		NC

Communication settings

Signal level	RS-232C	Character length	8 bits
Sync. method	Asynchronous	Stop bit	1 bit
Baud rate	9 600 bps	X parameter	None
Parity	None	S parameter	None

Basic format

STX	Command	:	Parameter	ETX
Start byte (02h)	3 bytes	1 byte	1 byte - 4 bytes	End (03h)

The data streaming from the computer will start with STX, and proceed to Command, Parameter and end with ETX. You can add the required parameter.

- The projector can not receive any command for approximately 10 seconds after the lamp is switched on and for approximately 1 second after the cooling fan stops operating and the projector has returned to standby mode (approximately 90 seconds after the indicator switches off).
Be sure to wait until the lengths of time mentioned above have passed before sending the command.
- If sending multiple commands, check that a response has been received from the projector for one command before sending the next command.
- When a command which does not require parameters to be sent, the colon (:) is not required.
- If an incorrect command is sent from the personal computer, the ER401 command will be sent from the projector to the personal computer.

Technical Information

■ Cable specifications

(When connected to a personal computer)

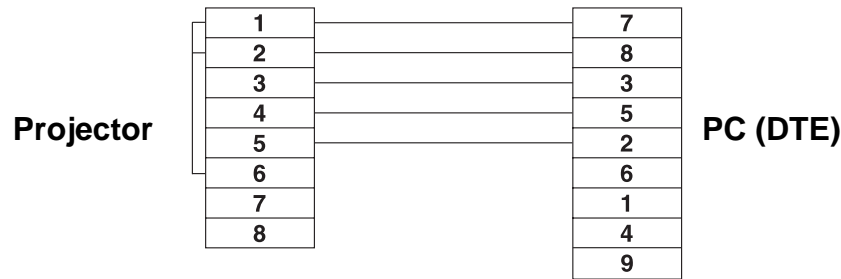

■ Control commands

Command	Control contents	Remarks
PON	Power ON	In standby mode, all commands other than the PON command are ignored. ● The PON command is ignored during lamp ON control.
POF	Power OFF	If a PON command is received while the cooling fan is operating after the lamp has switched off, the lamp is not turned back on again straight away in order to protect the lamp.
AVL	Volume	Parameter 000 - 063 (Adjustment value 0 - 63)
IIS	INPUT	Parameter: VID = VIDEO SVD = S-VIDEO RG1 = COMPUTER1 RG2 = COMPUTER2 NWP = WIRELESS (PT-LB51NTE only)
Q\$\$	Lamp condition query	Call back 0 = Standby 2 = Lamp ON 1 = Lamp ON control active 3 = Lamp OFF control active
OSH	SHUTTER	Turning off the projection temporarily. Send the command to switch between ON and OFF. Do not send the command consecutively. If a command other than "OSH" is sent to the projector when the shutter function is used, the "ER401" command will be sent from the projector to the computer and the shutter function will be turned off.

Computer connection guidance

You can switch the signals which to output from the **COMPUTER1 OUT** terminal by pressing the computer key command. The key commands are depend on the manufactures. If you select the computer terminals which has no signals while the **INPUT GUIDE** is set to **DETAILED**, the computer connection guidance will be displayed.

Manufacturer	Key command	Manufacturer	Key command	Manufacturer	Key command
Panasonic NEC	Fn + F3	TOSHIBA SHARP HP	Fn + F5	IBM SONY	Fn + F7
				Apple	F7
FUJITSU	Fn + F10	EPSON DELL	Fn + F8	Other	Fn + 

NOTE:

- The computer connection guidance will disappear after 5 minutes.
- Please refer the instructions which provided with the computers for more detailed information.

Technical Information

Specifications

Power supply		AC 100 - 240 V 50 Hz/60 Hz
Power consumption		240 W During standby (when fan is stopped): 4 W
Amps		2.8 A - 1.3 A
LCD panel	Panel size (diagonal)	0.6 type (15.24 mm)
	Aspect ratio	4 : 3
	Display method	3 transparent LCD panels (RGB)
	Drive method	Active matrix method
	Pixels	786 432 (1 024 x 768) x 3 panels
Lens		Manual zoom (1 - 1.2 x)/Manual focus F 1.6 - 1.9, f 18.8 mm - 22.6 mm
Lamp		UHM lamp (165 W)
Optical output*1		2 000 lm
Light output uniformity		90 %
Contrast ratio		400 : 1
Operating environment		Temperature 0 °C - 40 °C (32 °F - 104 °F) When the HIGHLAND (page 38) is set to ON: 0 °C - 35 °C (32 °F - 95 °F)
		Humidity 20% - 80% (no condensation)
Scanning frequency*2 (for RGB signal)	Horizontal scanning frequency	15 kHz - 91 kHz
	Vertical scanning frequency	50 Hz - 85 Hz
	Dot clock frequency	Less than 100 MHz
COMPONENT (YPBPR) signals		480i, 480p, 576i, 576p, 720/60p, 1 080/50i, 1 080/60i,
Colour system		7 (NTSC/NTSC 4.43/PAL/PAL-M/PAL-N/PAL60/SECAM)
Projection size		33" - 300" (838.2 mm - 7 620 mm)
Throw distance		1.1 m - 11.1 m (3'7" - 36'5")
Optical axis shift		6:1 (fixed)
Screen aspect ratio		4 : 3
Installation		FRONT/DESK, FRONT/CEILING, REAR/DESK, REAR/CEILING (Menu selection method)
Speaker		1 piece 4 cm X 2cm oval
Max. useable volume output		1.0 W (mono)

*1. Measurement, measuring conditions and method of notation all comply with ISO 21118 international standards.

*2. See "List of compatible signals" on page 46 for available signals.

Terminals	S-VIDEO IN	Single - line, Mini DIN 4p Y: 1.0 V [p-p], C: 0.286 V [p-p], 75 Ω	
	VIDEO IN	Single - line, RCA pin jack 1.0 V [p-p], 75Ω	
	COMPUTER1 IN	Single - line, D - sub HD 15-pin (female) During RGB signals input R.G.B. 0.7 V [p-p], 75 Ω G.SYNC 1.0 V [p-p], 75 Ω HD, VD TTL high impedance, automatic positive/negative polarity compatible	
		During YPBPR signals input Y 1.0 V [p-p] (Including sync), 75 Ω PB,PR 0.7 V [p-p], 75 Ω	
		Single - line, D - sub HD 15-pin (female) Selectable for input and output by menu operation. During RGB signals input/output R.G.B. 0.7 V [p-p], 75 Ω G.SYNC 1.0 V [p-p], 75 Ω HD, VD TTL high impedance, automatic positive/negative polarity compatible	
	COMPUTER2 IN/ 1 OUT	During YPBPR signals input Y 1.0 V [p-p] (Including sync), 75 Ω PB,PR 0.7 V [p-p], 75 Ω	
		AUDIO IN	Single - line, 0.5V [rms], RCA pin jack x 2 (L - R)
		COMPUTER AUDIO IN	Single - line, 0.5V [rms], M3 jack (Stereo MINI)
		VARIABLE AUDIO OUT	Single - line, 0.5V [rms], M3 jack (Stereo MINI) Monitor output/stereo compatible 0 V [rms] - 2.0 V [rms] (variable)
	SERIAL	DIN 8-pin RS-232C compatible	
Wireless LAN (PT-LB51NTE only)	Compatible	IEEE802.11b/IEEE802.11g (Wireless LAN standard protocol)	
	Wireless channel	IEEE802.11b/IEEE802.11g: 1 - 13 channels	
	Distance	30 m (98'5") Depends on the usage environment	
Cabinet		Moulded plastic (PC+ABS)	
Dimensions	Width	297 mm (11 - 11/16") 57 mm (2 - 7/32")	
	Height	(Not including the projection parts)	
	Length	210 mm (8 - 1/4")	
Weight		PT-LB51NTE: 1.9 kg (4.2 lbs.) PT-LB51E: 1.8 kg (4.0 lbs.)	
Certifications		EN60950, EN55022, EN61000-3-2, EN61000-3-3, EN55024	
Remote control	Power supply	3 V DC (AA batteries x 2)	
	Operating range	Approx. 15 m (49'2") (when operated directly in front of signal receptor)	
	Weight	117 g (4.2 ozs.) (including batteries)	
	Dimensions	Width	48 mm (1 - 7/8")
Length		163 mm (6 - 13/32")	
Height		24.5 mm (15/16") (not including surface projection parts)	
Options	Ceiling bracket	ET-PKB50	
	Wireless remote control unit	ET-RM300	
	Serial adapter	ET-ADSER (DIN 8-pin/D-sub 9-pin)	

Dimensions

<Units: mm (inch)>

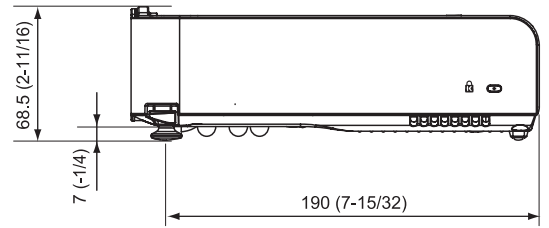
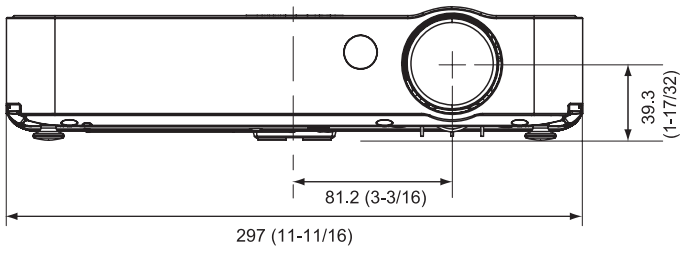
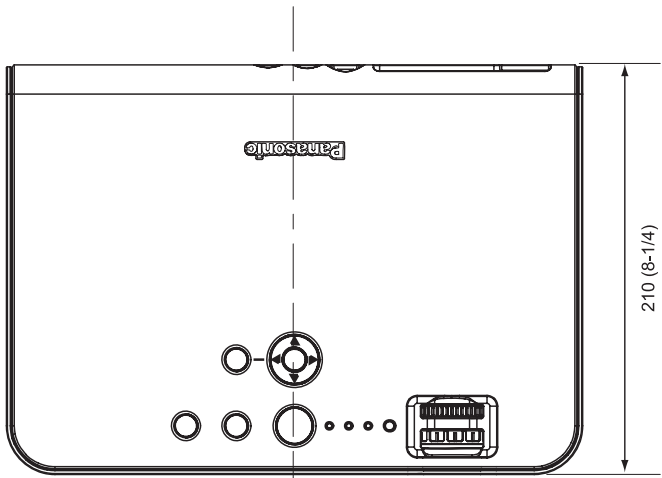

Trademark acknowledgements

- VGA and XGA are trademarks of International Business Machines Corporation.
- S-VGA is a registered trademark of the Video Electronics Standards Association.
- The font used in the on-screen displays is a Ricoh bitmap font, which is manufactured and sold by Ricoh Company, Ltd.

All other trademarks are the property of the various trademark owners.

Index

A		E	
AC IN	15	ENTER	
Accessories	11	Control panel button	14
AI	33	Remote control button	12
Air exhaust port	15	F	
Air filter	15	Focus ring	14, 24
Air intake port	15	FRAME LOCK	35
ASPECT	35	FREEZE	
AUDIO IN	15	Remote control	26
AUTO SETUP		Remote control button	12
Menu	37	Front adjustable legs	15, 17, 24
Remote control	25	Front leg adjusters	14, 17, 24
Remote control button	12	FUNCTION BUTTON	36
B		H	
BACK COLOR	38	Hand strap	13
Battery compartment	12	HIGHLAND	38
BLACKBOARD	38	I	
BRIGHTNESS	32	INDEX-WINDOW	
C		Remote control	27
Calculation methods		Remote control button	12
16:9	16	INPUT GUIDE	36
4:3	16	INPUT PASSWORD	39
CD-ROM		INPUT SELECT	
Accessories	11	Control panel button	14
Cleaning	42	Remote control button	12
CLOCK PHASE	34	Selecting	24, 26
COLOR	32	INSTALLATION	
COLOR TEMPERATURE	32	Menu	37
COMPUTER		Projection method	17
Connection guidance	49	K	
Remote control	26	KEYSTONE	34
Remote control button	12	L	
COMPUTER AUDIO IN	15	LAMP	
COMPUTER SEARCH (PT-LB51NTE only)	12	Indicator	14
COMPUTER1 IN	15	Indicator status	41
COMPUTER2 IN/1 OUT	15	LAMP RUNTIME	37
COMPUTER2 SELECT	36	Lamp unit compartment	15
Connections	18	Replacing	43
Connector Panel	15	LAMP POWER	36
CONTRAST	32	LANGUAGE	30, 35
CONTROL PANEL	14, 37	Luminance Sensor	14
D		M	
DAYLIGHT VIEW	33	Mains lead	
DEFAULT		Accessories	11
Remote control	27	Connecting	20
Remote control button	12	MENU	
DETAILED SETUP		Control panel button	14
OPTION menu	38	Main menu	30
PICTURE menu	33	Navigation	29
DIGITAL ZOOM		Remote control button	12
Remote control	28	MULTI-LIVE (PT-LB51NTE only)	12
Remote control button	12	N	
Dimensions	52	Navigation buttons	
Direct power off	20	Control panel button	14
DIRECT POWER ON		Remote control button	12
Function	20	NOISE REDUCTION	33
Menu	37		
DOT CLOCK	34		

O		TEXT CHANGE	39
	OPTION menu	TEXT DISPLAY	39
	OSD DESIGN	Throw distance	
P		16:9	16
	PAGE (PT-LB51NTE only)	4:3	16
	PASSWORD CHANGE	Throwing angle	17
	PICTURE menu	TINT	32
	PICTURE MODE	Troubleshooting	45
	POSITION	TV-SYSTEM	33
	POSITION menu	V	
	POWER	VARIABLE AUDIO OUT	15
	Control panel	VIDEO	
	Indicator status	Remote control	26
	Remote control button	Remote control button	12
	POWER OFF TIMER	VIDEO IN	15
	Projection lens	VOLUME	38
R		Remote control	28
	REALTIME KEYSTONE	Remote control button	12
	Remote control	W	
	Accessories	WHITE BALANCE	33
	Signal emitter	WIRELESS (PT-LB51NTE only)	
	Signal receptor	Remote control	26
	RESIZING	Remote control button	12
	RETURN	X	
	Remote control button	XGA MODE	38
	RGB/YPbPr	Z	
	Ring	Zoom ring	14, 24
	Focus ring		
	Zoom ring		
S			
	Screen size		
	16:9		
	4:3		
	Security lock		
	SECURITY menu		
	SERIAL		
	Basic format		
	Cable specifications		
	Communication settings		
	Connection		
	Control commands		
	Pin assignments		
	SHARPNESS		
	SHUTTER		
	Remote control		
	Remote control button		
	SIGNAL SEARCH		
	Speaker		
	Specifications		
	STARTUP LOGO		
	STILL MODE		
	Sub-menu		
	S-VIDEO IN		
	SXGA MODE		
T			
	Technical Information		
	TEMP		
	Indicator		
	Indicator status		

Panasonic Corporation

Web Site : <http://panasonic.net/avc/projector/>
© Panasonic Corporation 2009

Printed in Japan
S0607-6059G