

Panasonic
ideas for life

PT-F300 Series
LCD Projectors

PT-FW300NTE
PT-FW300E
PT-F300NTE
PT-F300E



**Designed for Durability
and
Installation Flexibility**

Performance You Can Count On



In addition to being bright and easy to use, the PT-F300 Series LCD projectors give you enhanced performance with minimal maintenance over time. Highly reliable optical block and a long operating life are ensured by the use of inorganic materials for the LCD panels and polarisers. The new Auto Cleaning Filter (ACF) extends the filter replacement cycle to over 10,000 hours;¹ and together with the dust-resistant design boost reliability.

High Durability for Long-Lasting Brightness

New Inorganic Materials Add Durability to the Optical Block

The F300 Series projectors' optical block maintains a high level of performance over time, due to the use of inorganic materials in the LCD panels and polarisers. It also makes them the logical choice for a truly dependable LCD projector system.

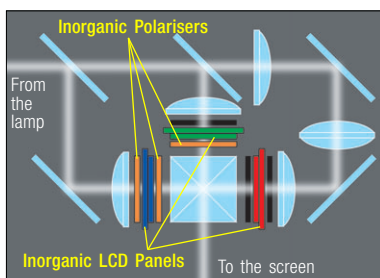

dust-resistant design, minimises brightness loss due to dust accumulation. As a result, the filter does not need to be replaced for over 10,000 hours;¹ greatly reducing the hassle of maintenance.



ACF brush

Dust-Resistant Design

In developing the dust-resistant design, Panasonic totally re-engineered the airflow path, from intake to exhaust, to create a cabinet that hermetically seals off the projector interior. This design and the ACF team up to keep the air inside the projector clean for long periods of time and minimise any brightness degradation.



The front panel covers the lens to protect from dust, and conceals the controls to prevent accidental misoperation. It can be opened for easy access to controls even after the projector is mounted to the ceiling.

Auto Cleaning Filter to Minimise Maintenance



Panasonic's proprietary Auto Cleaning Filter (ACF) uses a highly efficient electrostatic filter called the Micro Cut Filter. The ACF brushes away dust that adheres to the filter, which helps prevent clogging that can impair operation or cause malfunction. This helps maintain the Micro Cut Filter's superior dust-collecting performance and, coupled with a

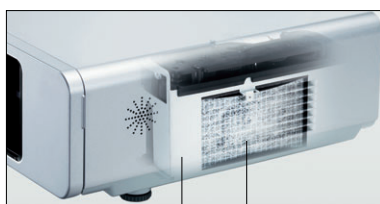

ACF unit

Micro Cut Filter

A highly efficient electrostatic filter in the air intake section traps dust particles that are 1 micron or larger. By capturing approximately seven times as more dust than conventional filters, it guards the optical block and reduces the penetration of dust into the interior to provide stable operation and halt drops in brightness.

5,000-Hour Lamp Life

Lamps used in a projector require much higher precision than ordinary household lamps. Panasonic employs a number of advanced technologies—including a proprietary lamp drive system—that help maintain optimal lamp performance for longer-lasting brightness. This has resulted in a 5,000-hour^{*2} lamp replacement cycle.

^{*1} The replacement cycle given here is a guideline. It may be shorter depending on the usage environment.

^{*2} This is a maximum value calculated by continuously turning the lamp on for 3.5 hours and off for 0.5 hour. The lamp replacement cycle will decrease if the lamp is turned on/off more frequently, or if it is left on for longer intervals.

Panasonic PT-F300 Series projectors boast superior installation flexibility and easy maintenance, making them the ideal choice for business or educational use.



Choose the One that Meets Your Needs



PT-FW300NTE

WXGA 3,500 lm Side by Side



PT-FW300E

WXGA 3,500 lm Side by Side



PT-F300NTE

XGA 4,000 lm



PT-F300E

XGA 4,000 lm



Looking to Replace Your Projectors?

Full of Features for Smooth Replacements

PT-F300 Series projectors make ideal replacements in existing systems. The 2x zoom lens and horizontal/vertical lens shift expand the applicable installation area, so you can place them in the same exact locations as your previous projectors. Abundant interfaces minimise additional cabling when replacing projectors. Using serial input and the Emulate function, you can continue to use the control commands of previous Panasonic models. The LAN terminals support PJLink™ class 1 connection for easy control when used in a multi-projector system. All of this means that the PT-F300 Series is your best choice both as a first-time projector and as a replacement.



Excellent Standard Features

Brightness of 4,000/3,500 lumens

A high-performance optical system combines with a high-efficiency 250 W UHM lamp to deliver a high brightness of 4,000 lumens (PT-F300NTE and PT-F300E) or 3,500 lumens (PT-FW300NTE and PT-FW300E). All models deliver crisp, bright images that are easy for the audience to see.

Daylight View 5 Gives Better Colour Perception for Easy Viewing in Various Lighting Conditions



The PT-F300 Series features Panasonic's Daylight View 5 technology. Remarkable detail is provided and perceived brightness and contrast are enhanced,*³ so images appear crisp, vivid, 3-dimensional and easy to see even in brightly lit rooms. Sharp edges are achieved with the "Edge Enhancer Control" and "Gamma Curve Control," while the perceived contrast is improved by extending the white level. Daylight View 5 operates in combination with a built-in ambient light sensor that automatically detects room brightness and adjusts operation accordingly.

Simulated image with Daylight View 5 turned off. Overall contrast appears lower, and images in dark areas cannot be seen.

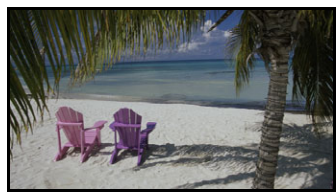

Simulated image with Daylight View 5 turned on. Detail, depth, brightness and contrast over the entire image are enhanced.



Wide Images (PT-FW300NTE/FW300E)

Wide Images (PT-FW300NTE/FW300E)

The PT-FW300NTE and PT-FW300E feature wide-aspect LCD panels, which allow native reproduction of WXGA (1,280 x 800) images from a PC. This provides a visually powerful display of wide-screen images from DVD sources, as well as wide-screen images from wide-aspect PCs, which are now the mainstream.



When projecting images from a source with a wide aspect ratio onto a 4:3 screen, the projector reduces the image to use only 75% of the screen area. Also, wide-screen projection makes it possible to display larger images where room for the screen height is limited.



Side-by-Side Function (PT-FW300NTE/FW300E)

The PT-FW300NTE and PT-FW300E can simultaneously display images from two sources*⁴ onto a single screen. For example, you can display a PC image on the right and a video image on the left. Taking advantage of the wide-screen projection, this function gives you a host of new application possibilities to explore.



With the wide-aspect-ratio capability, you can project two large 4:3 images side by side.

Easy Installation and Maintenance

Wide 2x Zoom and Horizontal/Vertical Lens Shift Give You More Installation Flexibility

Every model can project a 120-inch image from any distance between 3.6 m (11.8 feet) and 7.2 m (23.6 feet).^{*5} In new installations, this lets you accommodate a wide range of room sizes and shapes. And when replacing existing projectors, the 2x zoom greatly enhances your ease of installation and can reduce costs by permitting the use of existing mounting positions and cabling.

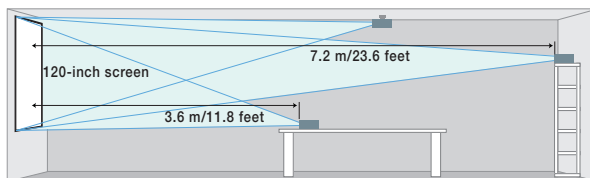

NOTE: This illustration shows the projection distances of the PT-F300NTE/F300E.

Wired LAN: Web Browser Control/Monitoring, E-Mail Message Alert

Anyone can operate a PT-F300 Series projector by remote control or monitor its status over a LAN network, because it is all done using the computer's familiar web browser. Furthermore, the projector sends an e-mail message to notify the operator when an error has occurred, or a lamp needs to be replaced.

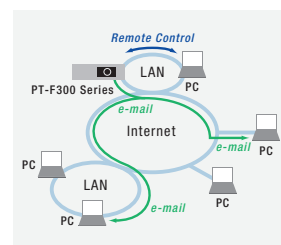

Controlling and Monitoring Multiple Projectors

Panasonic's original Multi Projector Monitoring & Control freeware*⁶ allows the user to control and monitor up to 1,024 projectors via LAN from a remote location. If a problem occurs, an alarm message is sent to the controlling/monitoring PC.

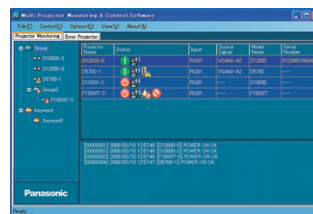

Abundant Connection Terminals

Designed for versatility, each projector comes equipped with a host of connection terminals, including a DVI-D input*⁷ and LAN terminal. Using the serial input, you can continue to use the control commands of previous Panasonic models with the Emulate function. This makes replacement quick and easy. Upon preference, audio out terminal can still be used during standby mode, so you can output audio without turning the projector on.

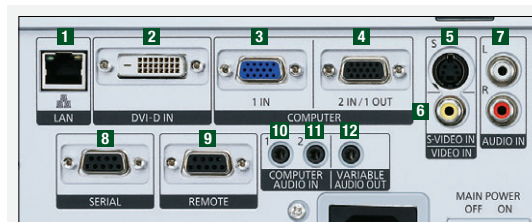

- | | |
|--------------------------------------|---|
| 1 LAN | 7 Audio input for S-Video and video |
| 2 DVI-D input (HDCP-compliant) | 8 Serial input |
| 3 Computer 1 input | 9 Remote input |
| 4 Computer 2 input/computer 1 output | 10 Audio input for computer 1 |
| 5 S-Video input | 11 Audio input for DVI-D and computer 2 |
| 6 Video input | 12 Variable audio output |

*³ There is no actual change in the rated brightness or contrast ratio.

*⁴ This function is not effective for some source combinations.

*⁵ For the PT-F300NTE and PT-F300E. For the PT-FW300NTE and FW300E with 16:10 projection, 3.4 m (11.2 feet) and 6.9 m (22.6 feet).

*⁶ Please consult a sales representative if necessary.

*⁷ HDCP-compliant. HDMI output connection is also possible by using a commercially available HDMI to DVI-D cable.

Direct Power Off

You can turn off the room's main power without waiting for the projector to cool down, because the fan keeps operating until the lamp returns to room temperature.

Easy Lamp Replacement

For easier maintenance, you can replace the lamp from the rear. The lamp is easily replaced even after the projector is installed on the ceiling. Furthermore, Panasonic PT-F300 Series projectors use the same lamp as the Panasonic PT-F100/F200 Series projectors, for efficient lamp purchase planning.

Easy Wireless Projection from Multiple PCs

(PT-FW300NTE/F300NTE)

With wireless capability, you don't need cables to connect a PC. That means it's easy to bring in a laptop (with a wireless LAN function) and deliver a smooth, hassle-free presentation. You can make the settings for wireless connection quickly and easily using Wireless Manager ME 5.5 software. When the presentation is finished, Wireless Manager restores the PC to its previous LAN settings, so the PC is ready to reconnect to your LAN. Functions include Live mode and Multi-Live mode. In Live mode, the image projected is identical to the image seen on the PC screen. In Multi-Live mode, you can wirelessly connect with multiple PCs.*⁸

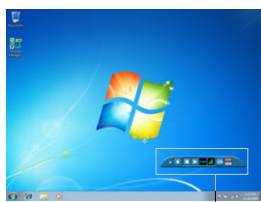

Launcher for Windows®



Launcher for Macintosh

Control Panel (Launcher)

To begin wireless projection, simply use the control panel (launcher).



Projector Signal Map

The signal map (S-MAP) graphically shows the strength of wireless connection signals. This is convenient for the users to determine which projector to use when multiple wireless projectors are used in adjacent rooms.

Four-window style

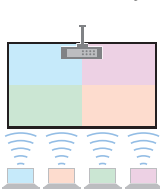

Index style (Four thumbnails)



Extended index style (16 thumbnails)

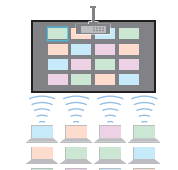

A Wide Variety of Wireless Functions

The PT-F300 Series projectors have a host of convenient wireless functions, including Wireless Prompter (Secondary Display Transmission), Selective Area Transmission and a 16-window index style that lets you project images from up to 16 PCs at the same time. Wireless transmission is possible from one PC to a maximum of eight projectors at a time.

Easy-to-Use Remote Control with Laser Pointer*⁹

The supplied remote control features a number of wireless projection controls, including Microsoft® PowerPoint® page up/down capability. A frequently used function can also be assigned to the Function button.*¹⁰ In addition, remote control operation from as far away as approximately 15 meters (49.2 feet) is possible.*¹¹



Convenient Function button



Photo shows the remote for the PT-FW300NTE.

Other Valuable Features

- Anti-theft features: Security anchor, user password, control panel lock and text superimposing
- HDTV compatibility
- Picture mode selection (standard/dynamic/natural/cinema/blackboard)
- AV mute for image/sound muting
- Selectable 17-language onscreen menu
- Menu lock function

Made in Japan

All PT-F300 Series projectors are carefully manufactured at the Panasonic factory in Japan under strict quality control.



Options



Replacement lamp unit ET-LAF100



Replacement filter unit ET-ACF100



Ceiling mount bracket for high ceilings ET-PKF100H



Ceiling mount bracket for low ceilings ET-PKF100S

To use wireless or wired LAN functions, a PC is required to meet the following conditions:

| | | |
|-----------------------------------|--|--|
| OS: | Microsoft® | Windows® 2000: Professional SP4 Windows® XP: Professional, Home Edition, Tablet PC Edition 2005 Windows Vista®: Ultimate 32/64 bit, Business 32/64 bit, Home Premium 32/64 bit, Home Basic 32/64 bit Windows® 7: Ultimate 32/64 bit, Professional 32/64 bit, Home Premium 32/64 bit |
| | Apple | Mac OS: Mac OS X 10.4/10.5/10.6 |
| | NOTE: With Mac OS X, operation is guaranteed only with preinstalled or clean-installed operating systems. Some functions are not available with Windows Vista®, Windows 7 and Mac OS X. | |
| CPU: | Windows®: | Intel® Pentium® III or higher, or other compatible processor (1 GHz or higher is recommended.) |
| | Macintosh: | 1 GHz or higher PowerPC G4, or 1.8 GHz or higher Intel® Core™ processor |
| RAM: | Windows®: | 256 MB or more is recommended. |
| | Macintosh: | 512 MB or more is recommended. |
| Free hard disk space: | | 60 MB or more |
| Hardware conditions: | | CD-ROM drive or DVD drive |
| Wireless LAN (PT-FW300NT/F300NT): | | IEEE 802.11b/g compatible (built-in wireless LAN system or external IEEE 802.11b/g LAN card must be installed.) |
| Web browser: | Windows®: | Internet Explorer® 6.0/7.0/8.0 |
| | Mac OS: | Safari 2.0/3.0/4.0 |
| Wired LAN connector: | | RJ-45 |
| | NOTE: Some IEEE 802.11g/b wireless LAN may not allow connection to the projector. | |

ECOLOGY-CONSCIOUS DESIGN

Panasonic works from every angle to minimise environmental impact in the product design, production and delivery processes, and in the performance of the product itself over its life cycle. The PT-F300 Series reflects the following ecological considerations.

- RoHS compliance.
- Lead-free solder is used to mount components to the printed circuit boards.
- No halogenated flame retardants are used in the cabinet.
- Lenses contain a minimal amount of lead.

*⁸ Live mode and Multi-Live mode can also be used with a wired LAN system.

*⁹ The laser pointer can be disabled.

*¹⁰ The following functions can be assigned: aspect menu, picture mode, and Daylight View menu.

*¹¹ When operated from directly in front of the signal receptor. The operating range depends on the environment.

Specifications (The specifications and design are subject to change without notice as product development proceeds.)

| Models | PT-FW300NTE | PT-FW300E | PT-F300NTE | PT-F300E |
|-------------------------------|--|---|---|---|
| Power supply | 100–240 V AC, 50/60 Hz | | | |
| Power consumption | 350 W (Approx. 4 W in standby mode with fan stopped. Approx. 25 W when in network standby mode, and approx. 35 W when audio is set to output during standby mode.) | | | |
| LCD panel | Panel size | 0.75" (19.05 mm) diagonal, 16:10 aspect ratio | | 0.8" (20.32 mm) diagonal, 4:3 aspect ratio |
| | Pixels | 1,024,000 (1,280 x 800) x 3, total of 3,072,000 pixels | | 786,432 (1,024 x 768) x 3, total of 2,359,296 pixels |
| Lamp | 250 W UHM lamp | | | |
| Brightness*1 | 3,500 lumens | | 4,000 lumens | |
| Centre-to-corner uniformity*1 | 80 % | | | |
| Contrast ratio*1 | 600:1 | | | |
| Lens | Manual zoom (1:1–1:1.2), manual focus, F 1.7–2.6, f 21.6–43.0 mm | | Manual zoom (1:1–1:1.2), manual focus, F 1.7–2.6, f 24.0–47.2 mm | |
| | Projection size (diagonally) | 838–7,620 mm (33–300 inches) diagonally, 16:10 aspect ratio | | 838–7,620 mm (33–300 inches) diagonally, 4:3 aspect ratio |
| | Optical axis shift*2 | Vertical: ±51%, horizontal: ±24% | | Vertical: ±50%, horizontal: ±27% |
| Keystone correction range | Vertical: ±30° | | | |
| Scanning frequency | RGB | Horizontal: 15–91 kHz, Vertical: 50–85 Hz | | |
| | YPbPr | 480i (525i), 480p (525p), 576i (625i), 576p (625p), 720 (750)/60p, 720 (750)/50p, 1080 (1125)/60i, 1080 (1125)/50i, 1080 (1125)/60p, 1080 (1125)/50p | | |
| | S-Video/Video | NTSC, NTSC4.43, PAL-M, PAL60: f _H 15.75 kHz; f _V 60 Hz PAL, SECAM, PAL-N: f _H 15.63 kHz; f _V 50 Hz | | |
| Built-in speakers | 5.0 W (monaural) output power | | | |
| Terminals | DVI-D IN | DVI-D 24-pin | | |
| | COMPUTER 1 IN | D-sub HD 15-pin x 1 | | |
| | COMPUTER 2 IN/1 OUT | D-sub HD 15-pin x 1 (input/output selectable using on-screen menu) | | |
| | VIDEO IN | RCA pin x 1 | | |
| | S-VIDEO IN | Mini DIN 4-pin x 1 | | |
| | COMPUTER 1 AUDIO IN | M3 (stereo) x 1 (for COMPUTER 1) | | |
| | COMPUTER 2 AUDIO IN | M3 (stereo) x 1 (for DVI-D and COMPUTER 2) | | |
| | AUDIO IN | RCA (L-R) x 1 (for VIDEO/S-VIDEO) | | |
| | VARIABLE AUDIO OUT | M3 (stereo) x 1 | | |
| | SERIAL | D-sub 9-pin x 1 (RS-232C) | | |
| | REMOTE | D-sub 9-pin x 1 | | |
| | LAN | RJ45 | | |
| | Wireless LAN | IEEE802.11b/g | — | IEEE802.11b/g |
| Dimensions*3 (W x H x D) | 432 x 128.5 x 323 mm (17" x 5-1/16" x 12-23/32") | | | |
| Weight*4 | Approx. 6.2 kg (13.7 lbs.) | | | |
| Supplied accessories | Power cord, power cord secure lock, wireless remote control, batteries for remote control (R6/LR6 type x 2), Wireless Manager ME 5.5 (CD-ROM), safety wire rope | | | |
| Optional accessories | ET-LAF100 replacement lamp unit, ET-ACF100 replacement filter unit, ET-PKF100H ceiling mount bracket for high ceilings, ET-PKF100S ceiling mount bracket for low ceilings | | | |

*1 Measurement, measuring conditions, and method of notation all comply with ISO 21118 international standards. *2 Shift range is limited during simultaneous horizontal and vertical shifting. *3 Including protruding parts. *4 Average value. May differ depending on models.

PT-FW300NTE/FW300E Projection Distance (16:10)

| Projection size (diagonal) | Projection distance (L) | | Height from the edge of screen to centre of lens (H) |
|----------------------------|-------------------------|-----------------|--|
| | Min (wide) | Max (telephoto) | |
| 0.84 m / 33" | — / — | 1.8 m / 6.2' | 0 – 0.23 m / 0 – 0.8' |
| 1.02 m / 40" | 1.1 m / 3.6' | 2.3 m / 7.6' | 0 – 0.28 m / 0 – 0.9' |
| 1.52 m / 60" | 1.7 m / 5.5' | 3.4 m / 11.5' | 0 – 0.42 m / 0 – 1.4' |
| 2.03 m / 80" | 2.3 m / 7.4' | 4.6 m / 15.3' | 0 – 0.55 m / 0 – 1.8' |
| 2.54 m / 100" | 2.9 m / 9.3' | 5.7 m / 19.2' | 0 – 0.69 m / 0 – 2.3' |
| 3.81 m / 150" | 4.3 m / 14.1' | 8.6 m / 28.9' | 0 – 1.04 m / 0 – 3.4' |
| 5.08 m / 200" | 5.7 m / 18.8' | 11.5 m / 38.6' | 0 – 1.39 m / 0 – 4.5' |
| 7.62 m / 300" | 8.6 m / 28.3' | 17.2 m / 58.1' | 0 – 2.08 m / 0 – 6.8' |

PT-FW300NTE/FW300E Projection Distance (16:9)

| Projection size (diagonal) | Projection distance (L) | | Height from the edge of screen to centre of lens (H) |
|----------------------------|-------------------------|-----------------|--|
| | Min (wide) | Max (telephoto) | |
| 0.84 m / 33" | — / — | 1.9 m / 6.2' | 0 – 0.24 m / 0 – 0.8' |
| 1.02 m / 40" | 1.2 m / 3.8' | 2.3 m / 7.6' | 0 – 0.29 m / 0 – 0.9' |
| 1.52 m / 60" | 1.8 m / 5.7' | 3.5 m / 11.5' | 0 – 0.43 m / 0 – 1.4' |
| 2.03 m / 80" | 2.4 m / 7.6' | 4.7 m / 15.3' | 0 – 0.57 m / 0 – 1.9' |
| 2.54 m / 100" | 3.0 m / 9.6' | 5.9 m / 19.2' | 0 – 0.71 m / 0 – 2.3' |
| 3.81 m / 150" | 4.5 m / 14.5' | 8.8 m / 28.9' | 0 – 1.07 m / 0 – 3.5' |
| 5.08 m / 200" | 5.9 m / 19.3' | 11.8 m / 38.6' | 0 – 1.43 m / 0 – 4.7' |
| 7.62 m / 300" | 8.9 m / 29.1' | 17.7 m / 58.1' | 0 – 2.14 m / 0 – 7.0' |

PT-F300NTE/F300E Projection Distance (4:3)

| Projection size (diagonal) | Projection distance (L) | | Height from the edge of screen to centre of lens (H) |
|----------------------------|-------------------------|-----------------|--|
| | Min (wide) | Max (telephoto) | |
| 0.84 m / 33" | — / — | 1.9 m / 6.4' | 0 – 0.25 m / 0 – 0.8' |
| 1.02 m / 40" | 1.2 m / 3.8' | 2.4 m / 7.8' | 0 – 0.30 m / 0 – 1.0' |
| 1.52 m / 60" | 1.8 m / 5.8' | 3.6 m / 11.7' | 0 – 0.46 m / 0 – 1.5' |
| 2.03 m / 80" | 2.4 m / 7.8' | 4.8 m / 15.7' | 0 – 0.61 m / 0 – 2.0' |
| 2.54 m / 100" | 3.0 m / 9.9' | 6.0 m / 19.7' | 0 – 0.76 m / 0 – 2.5' |
| 3.81 m / 150" | 4.5 m / 14.9' | 9.0 m / 29.6' | 0 – 1.14 m / 0 – 3.8' |
| 5.08 m / 200" | 6.1 m / 19.9' | 12.0 m / 39.5' | 0 – 1.52 m / 0 – 5.0' |
| 7.62 m / 300" | 9.1 m / 29.9' | 18.1 m / 59.3' | 0 – 2.29 m / 0 – 7.5' |

NOTES ON USE

- The projector uses a high-voltage mercury lamp that contains high internal pressure. This lamp may break, emitting a large sound, or fail to illuminate, due to impact or extended use. The length of time that it takes for the lamp to break or fail to illuminate varies greatly depending on individual lamp characteristics and usage conditions.
- The brightness of the lamp will gradually decrease with use.
- The projector includes consumable parts. The frequency of replacement for the lamp and other consumable parts will increase if the projector is subjected to extended, continuous use. For details, please consult a service representative.

Dimensions

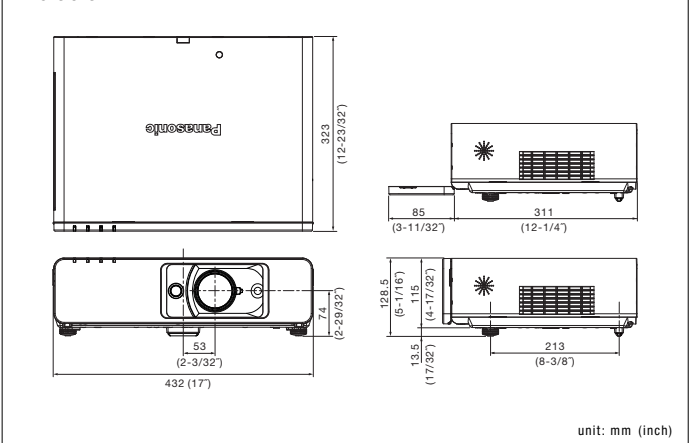

For more information about Panasonic projectors
<http://panasonic.net/avc/projector>



Weights and dimensions shown are approximate. Specifications are subject to change without notice. Product availability differs depending on region and country. This product may be subject to export control regulations. Intel, Pentium, and Intel Core are trademarks or registered trademarks of Intel Corporation or its subsidiaries in the United States and other countries. Microsoft, Windows Vista and Windows are either registered trademarks or trademarks of Microsoft Corp. in the United States and/or other countries. Apple, Mac, Mac OS, and Macintosh are trademarks of Apple Inc., registered in the U.S. and other countries. PowerPC is a trademark of International Business Machines Corporation, registered in the U.S. P.JLink is a registered trademark or trademark in Japan, the United States, and other countries and regions. All other trademarks are the property of their respective trademark owners. Projection images simulated.

All information included here is valid as of February 2010.

PT-F300NTE2 Printed in Japan.