

Panasonic®

Operating Instructions Projector Operations

DLP™ Based Projector Commercial Use

Model No. PT-CW230EA
PT-CX200EA

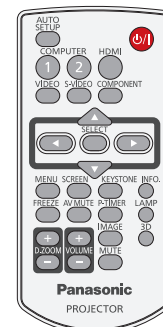
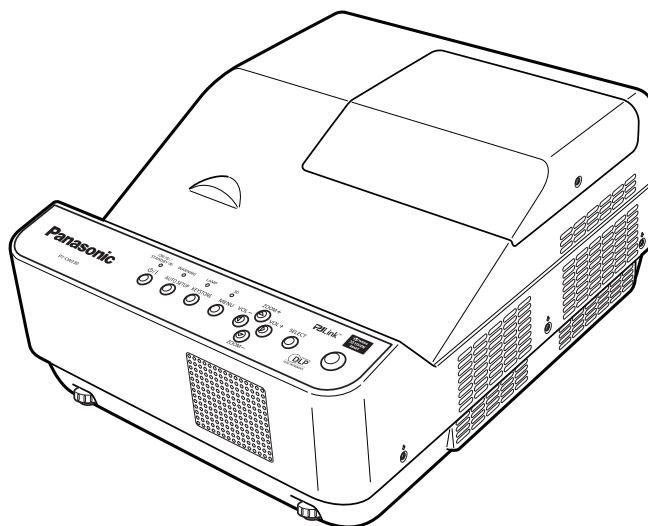

Thank you for purchasing this Panasonic Product.

■ Before operating this product, please read the instructions carefully, and save this manual for future use.

For information on using the product via a network, refer to “Operating Instructions – Network Operations”.

ENGLISH

PB2SC

Read this first!

WARNING: THIS APPARATUS MUST BE EARTHED.

WARNING: To prevent damage which may result in fire or shock hazard, do not expose this appliance to rain or moisture.

Machine Noise Information Ordinance 3. GSGV, January 18, 1991: The sound pressure level at the operator position is equal or less than 70 dB (A) according to ISO 7779.

WARNING:

1. Remove the plug from the mains socket when this unit is not in use for a prolonged period of time.
2. To prevent electric shock, do not remove cover. No user serviceable parts inside. Refer servicing to qualified service personnel.
3. Do not remove the earthing pin on the mains plug. This apparatus is equipped with a three prong earthing type mains plug. This plug will only fit an earthing-type mains socket. This is a safety feature. If you are unable to insert the plug into the mains socket, contact an electrician. Do not defeat the purpose of the earthing plug.

CAUTION: To assure continued compliance, follow the attached installation instructions, which includes using the provided power cord and shielded interface cables when connecting to computer or peripheral device. If you use serial port to connect PC for external control of projector, you must use optional RS-232C serial interface cable with ferrite core. Any unauthorized changes or modifications to this equipment will void the user's authority to operate.



WARNING:

TURN OFF THE UV LAMP BEFORE OPENING THE LAMP COVER.

WARNING: TO REDUCE THE RISK OF FIRE OR ELECTRIC SHOCK, DO NOT EXPOSE THIS PRODUCT TO RAIN OR MOISTURE.

WARNING: RISK OF ELECTRIC SHOCK, DO NOT OPEN.



The lightning flash with arrowhead symbol, within an equilateral triangle, is intended to alert the user to the presence of uninsulated "dangerous voltage" within the product's enclosure that may be of sufficient magnitude to constitute a risk of electric shock to persons.



The exclamation point within an equilateral triangle is intended to alert the user to the presence of important operating and maintenance (servicing) instructions in the literature accompanying the product.

IMPORTANT: THE MOULDED PLUG (U.K. only)FOR YOUR SAFETY, PLEASE READ THE FOLLOWING TEXT CAREFULLY.

This appliance is supplied with a moulded three pin mains plug for your safety and convenience. A 13 amp fuse is fitted in this plug. Should the fuse need to be replaced, please ensure that the replacement fuse has a rating of 13 amps and that it is approved by ASTA or BSI to BS1362.

Check for the ASTA mark  or the BSI mark  on the body of the fuse.

If the plug contains a removable fuse cover, you must ensure that it is refitted when the fuse is replaced. If you lose the fuse cover, the plug must not be used until a replacement cover is obtained. A replacement fuse cover can be purchased from an Authorised Service Center.

If the fitted moulded plug is unsuitable for the mains socket in your home, then the fuse should be removed and the plug cut off and disposed of safely. There is a danger of severe electrical shock if the cut off plug is inserted into any 13 amp socket.

If a new plug is to be fitted, please observe the wiring code as shown below.
If in any doubt, please consult a qualified electrician.

WARNING: THIS APPLIANCE MUST BE EARTHED.

IMPORTANT: The wires in this mains lead are coloured in accordance with the following code:

Green - and - Yellow:	Earth
Blue:	Neutral
Brown:	Live

As the colours of the wire in the mains lead of this appliance may not correspond with the coloured markings identifying the terminals in your plug, proceed as follows.

The wire which is coloured GREEN - AND - YELLOW must be connected to the terminal in the plug which is marked with the letter E or by the Earth symbol  or coloured GREEN or GREEN - AND - YELLOW.

The wire which is coloured BLUE must be connected to the terminal in the plug which is marked with the letter N or coloured BLACK.

The wire which is coloured BROWN must be connected to the terminal in the plug which is marked with the letter L or coloured RED.

How to replace the fuse: Open the fuse compartment with a screwdriver and replace the fuse.

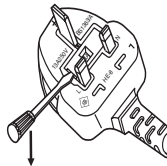

Read this first!

WARNING:

■ POWER

The wall outlet or the circuit breaker shall be installed near the equipment and shall be easily accessible when problems occur. If the following problems occur, cut off the power supply immediately.

Continued use of the projector in these conditions will result in fire or electric shock.

- If foreign objects or water get inside the projector, cut off the power supply.
- If the projector is dropped or the cabinet is broken, cut off the power supply.
- If you notice smoke, strange smells or noise coming from the projector, cut off the power supply.

Please contact an Authorized Service Center for repairs, and do not attempt to repair the projector yourself.

During a thunderstorm, do not touch the projector or the cable.

Electric shocks can result.

Do not do anything that might damage the power cord or the power plug.

If the power cord is used while damaged, electric shocks, short-circuits or fire will result.

- Do not damage the power cord, make any modifications to it, place it near any hot objects, bend it excessively, twist it, pull it, place heavy objects on top of it or wrap it into a bundle.

Ask an Authorized Service Center to carry out any repairs to the power cord that might be necessary.

Insert the power plug securely into the wall outlet.

If the plug is not inserted correctly, electric shocks or overheating will result.

- Do not use anything other than the provided power cord.
- Do not use the provided power cord for other electrical equipment.
- Do not use plugs which are damaged or wall outlets which are coming loose from the wall.

Clean the power plug regularly to prevent it from becoming covered in dust.

Failure to observe this will cause a fire.

- If dust builds up on the power plug, the resulting humidity can damage the insulation.
- If not using the projector for an extended period of time, pull the power plug out from the wall outlet.

Pull the power plug out from the wall outlet and wipe it with a dry cloth regularly.

Do not handle the power plug with wet hands.

Failure to observe this will result in electric shocks.

Do not overload the wall outlet.

If the power supply is overloaded (ex., by using too many adapters), overheating may occur and fire will result.

■ ON USE/INSTALLATION

Do not place liquid containers on top of the projector.

If water spills onto the projector or gets inside it, fire or electric shocks will result.

If any water gets inside the projector, contact an Authorized Service Center.

Do not place the projector on soft materials such as carpets or sponge mats.

Doing so will cause the projector to overheat, which can cause burns, fire or damage to the projector.

Do not set up the projector in humid or dusty places or in places where the projector may come into contact with oily smoke or steam, ex. a bathroom.

Using the projector under such conditions will result in fire, electric shocks or components deterioration.

Components deterioration (such as ceiling mount brackets) may cause the projector which is mounted on the ceiling to fall down.

Do not install this projector in a place which is not strong enough to take the full weight of the projector or on top of a surface which is sloped or unstable.

Failure to observe this will cause projector to fall down or tip over the projector, and severe injury or damage could result.

Do not place another projector or other heavy objects on top of the projector.

Failure to observe this will cause the projector to become unbalanced and fall, which could result in damage or injury. The projector will be damaged or deformed.

WARNING:**Installation work (such as ceiling mount bracket) should only be carried out by a qualified technician.**

If installation is not carried out and secured correctly it can cause injury or accidents, such as electric shocks.

- Do not use anything other than an authorized ceiling mount bracket.
- Be sure to use the wire provided with the projector mount base for ceiling mount as an extra safety measure to prevent the projector from falling down. (Install in a different location to the ceiling mount bracket).

Do not cover the air inlet port or the air outlet port.

Doing so will cause the projector to overheat, which can cause fire or damage to the projector.

- Do not place the projector in narrow, badly ventilated places.
- Do not place the projector on cloth or papers, as these materials could be drawn into the air inlet port.

Do not place your hands or other objects close to the air outlet port.

Doing so will cause burns or damage your hands or other objects.

- Heated air comes out of the air outlet port. Do not place your hands or face, or objects which cannot withstand heat close to this port.

Do not look and place your skin into the lights emitted from the projection window while the projector is being used.

Doing so can cause burns or loss of sight.

- Strong light is emitted from the projector's projection window. Do not look or place your hands directly into this light.
- Be especially careful not to let young children look into the projection window. In addition, turn off the power and disconnect the power plug when you are away from the projector.

Do not insert any foreign objects into the projector.

Doing so will cause fire or electric shocks.

- Do not insert any metal objects or flammable objects into the projector or drop them onto the projector.

Never attempt to remodel or disassemble the projector.

High voltages can cause fire or electric shocks.

- For any inspection, adjustment and repair work, please contact an Authorized Service Center.

Do not allow metal objects, flammable objects, or liquids to enter inside of the projector. Do not allow the projector to get wet.

Doing so may cause short circuits or overheating, and result in fire, electric shock, or malfunction of the projector.

- Do not place containers of liquid or metal objects near the projector.
- If liquid enters inside of the projector, consult your dealer.
- Particular attention must be paid to children.

Use the ceiling mount bracket specified by Panasonic.

Defects in the ceiling mount bracket will result in falling accidents.

- Attach the supplied safety cable to the ceiling mount bracket to prevent the projector from falling down.

Read this first!

WARNING:

■ ACCESSORIES

Do not use or handle the batteries improperly, and refer to the following.

Failure to observe this will cause burns, batteries to leak, overheat, explode or catch fire.

- Do not use unspecified batteries.
- Do not disassemble dry cell batteries.
- Do not heat the batteries or place them into water or fire.
- Do not allow the + and – terminals of the batteries to come into contact with metallic objects such as necklaces or hairpins.
- Do not store batteries together with metallic objects.
- Store the batteries in a plastic bag and keep them away from metallic objects.
- Make sure the polarities (+ and –) are correct when inserting the batteries.
- Do not use a new battery together with an old battery or mix different types of batteries.
- Do not use batteries with the outer cover peeling away or removed.
- Remove the empty batteries from the remote control at once.
- Insulate the battery using tape or something similar before disposal.

Do not allow children to reach the batteries (AAA/R03 or AAA/LR03 type).

- The battery can cause personal injury if swallowed.
- If swallowed, seek medical advice immediately.

If the battery fluid leaks, do not touch it with bare hands, and take the following measures if necessary.

- Battery fluid on your skin or clothing could result in skin inflammation or injury.
Rinse with clean water and seek medical advice immediately.
- Battery fluid coming in contact with your eyes could result in loss of sight.
In this case, do not rub your eyes. Rinse with clean water and seek medical advice immediately.

Do not disassemble the lamp unit.

If the lamp breaks, it could cause injury.

Lamp replacement

The lamp has high internal pressure. If improperly handled, an explosion and severe injury or accidents will result.

- The lamp can easily explode if struck against hard objects or dropped.
- Before replacing the lamp, be sure to disconnect the power plug from the wall outlet.
Electric shocks or explosions can result if this is not done.
- When replacing the lamp, turn the power off and allow the lamp to cool for at least 1 hour before handling it otherwise it can cause burns.

Do not allow infants or pets to touch the remote control unit.

- Keep the remote control unit out of the reach of infants and pets after using it.

Do not use the supplied power cord with devices other than this projector.

- Using the supplied power cord with devices other than this projector may cause short circuits or overheating, and result in electric shock or fire.

Remove the depleted batteries from the remote control promptly.

- Leaving them in the unit may result in fluid leakage, overheating, or explosion of the batteries.

CAUTION:

■ **POWER**

When disconnecting the power cord, be sure to hold the power plug and power connector.

If the power cord itself is pulled, the lead will become damaged, and fire, short-circuits or serious electric shocks will result.

When not using the projector for an extended period of time, disconnect the power plug from the wall outlet and remove the batteries from the remote control.

Disconnect the power plug from the wall outlet before carrying out any cleaning and replacing the unit. Electric shocks can result if this is not done.

■ **ON USE/INSTALLATION**

Do not put your weight on this projector.

You could fall or the projector could break, and injury will result.

- Be especially careful not to let young children stand or sit on the projector.

Do not place the projector in extremely hot locations.

Doing so will cause the outer casing or internal components to deteriorate, or result in fire.

- Take particular care in locations exposed to direct sunlight or near stoves.

Always disconnect all cables before moving the projector.

Moving the projector with cables still attached can damage the cables, which will cause fire or electric shocks to occur.

Never plug headphones and earphones into AUDIO OUT jack.

Excessive sound pressure from earphones and headphones can cause hearing loss.

■ **ACCESSORIES**

Do not use the old lamp unit.

If used it could cause lamp explosion.

If the lamp has broken, ventilate the room immediately. Do not touch or bring your face close to the broken pieces.

Failure to observe this will cause the user to absorb the gas which was released when the lamp broke and which contains nearly the same amount of mercury as fluorescent lamps, and the broken pieces will cause injury.

- If you believe that you have absorbed the gas or that the gas has got into your eyes or mouth, seek medical advice immediately.
- Ask your dealer about replacing the lamp unit and check the inside of the projector.



To remove the battery

Remote Control Battery

1. Press the guide and lift the cover.

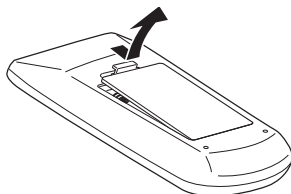

2. Remove the batteries.

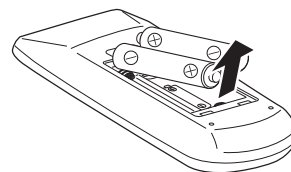

Read this first!

Trademarks

- HDMI, the HDMI logo and High-Definition Multimedia Interface is a trademark or registered trademark of HDMI Licensing LLC.



- NVIDIA®, the NVIDIA® logo, and 3D VISION™ are registered trademarks and/or trademarks of NVIDIA Corporation in the United States and other countries.
- Other names, company names or product names used in these operating instructions are the trademarks or registered trademarks of their respective holders.

Please note that the operating instructions do not include the ® and ™ symbols.

Illustrations in these operating instructions

- Note that illustrations of the projector and screens may differ from the ones you actually see.

Page references

- In these instructions, references to pages are indicated as: (➡ page 00).

Term

- In these instructions, the “Wireless remote control unit” accessory is referred to as the “Remote control”.

■ Features of the Projector

Auto Setup Function

- ▶ This function enables Input search and Auto PC adjustment by pressing the <AUTO SETUP> button.

Direct Power Off Function

- ▶ With the Direct Power Off function, you can disconnect the power cord from the wall outlet or turn off the breaker even during projection.

Large Screen in Limited Space

- ▶ Short focus lens allows you to project large images from short distance.

LAN Network Function

- ▶ This function allows you to operate and manage the projector via network.

3D Display Function

- ▶ This projector is capable of displaying 3D video with the Frame Sequential Format, and you can view the dynamic 3D contents by wearing 3D glasses.

■ Quick steps

For details, see the corresponding pages.

1. **Set up your projector.**
(⇒ page 21)



2. **Connect with other devices.**
(⇒ page 25)



3. **Connect the power cord.**
(⇒ page 26)



4. **Power on.**
(⇒ page 28)



5. **Select the input signal.**
(⇒ page 31)



6. **Adjust the image.**
(⇒ page 31)

Contents

Be sure to read "Read this first!". (➔ pages 2 to 8)

Important Information

Read this first!	2
Contents	10
Precautions for Use	12
Cautions when transporting.....	12
Cautions when installing.....	12
Security	13
Disposal.....	13
Cautions on use	14
Accessories.....	16
Optional accessories.....	16

Preparation

About Your Projector	17
Remote control.....	17
Projector body	18
Control panel	19
Side terminals.....	19
Using Remote control	20
Installing and Removing batteries	20
Setting Remote control ID numbers	20

Getting Started

Setting up	21
Projection method	21
Parts for ceiling or wall mount (Optional)	21
Screen size and throw distance	22
Adjusting front adjustable feet.....	24
Connections	25
Before connecting to the projector	25
Connecting example.....	25

Basic Operation

Powering ON/OFF	26
Connecting the power cord	26
ON(G)/STANDBY(R) indicator.....	27
Turning On the Projector	28
Enter a PIN code	29
Turning Off the Projector	30
Projecting	31
Selecting the image.....	31
How to adjust the state of the image.....	31
For Viewing 3D Contents	32

Basic operations by using the remote control..... 33

Using the AUTO SETUP function.....	33
Switching the input signal.....	33
Using the SCREEN button	33
Using the KEYSTONE button.....	34
Using the INFO. button.....	34
Using the FREEZE function	34
Using the AV MUTE function	35
Using the P-TIMER button	35
Using the LAMP button	35
Using the D.ZOOM buttons.....	35
Controlling the volume of the speaker.....	35
Using the IMAGE button.....	35
Using the 3D button.....	36
Using the MUTE button	36

Settings

Menu Navigation	37
Navigating through the menu	37
Main menu.....	38
Sub menu	38
Input menu	40
Computer 1: RGB/Component /RGB (Scart)	40
Computer 2: RGB.....	40
HDMI	41
Video	41
S-video	41
AUTO PC adjust	42
AUTO PC adj.....	42
Manual PC adjust	43
Fine sync	43
Total dots	43
Horizontal	43
Vertical.....	43
Current mode	44
Clamp	44
Reset	44
Mode free	44
Store.....	44
Image select	45
Dynamic	45
Standard.....	45
Real.....	45
Cinema	45
Image 1-4	45
Image adjust	46
Contrast.....	46
Brightness	46

Color.....	46	Lamp runtime	58
Tint	46	Filter counter	59
Color temp.....	46	Factory default.....	59
Red	47	Information.....	60
Green	47	Input Source Information Display	60
Blue	47		
Sharpness	47		
Gamma.....	47		
Noise reduction	47		
Progressive	48		
Reset.....	48		
Store.....	48		
Screen	49		
Normal.....	49		
Full	49		
Wide(16:9).....	49		
Zoom	49		
True	49		
Natural wide (PT-CW230EA Only).....	49		
Custom	49		
Custom adj.	50		
Digital zoom +.....	50		
Digital zoom -	50		
Keystone	50		
Ceiling	51		
Rear.....	51		
Screen aspect (PT-CW230EA Only)	51		
Colorboard.....	51		
Reset	51		
Sound	52		
Volume	52		
Mute	52		
Setting	53		
Language	53		
Menu position.....	53		
Auto setup	53		
3D setting	54		
Zoom	54		
Background	54		
Display.....	54		
Logo	55		
HDMI setup	55		
Terminal.....	55		
Standby mode	56		
Power management	56		
Direct on	56		
Closed caption.....	56		
Lamp power.....	57		
Remote control	57		
Security	57		
Fan	58		
Fan control	58		

Precautions for Use

Cautions when transporting

- When transporting the projector, hold it securely by its bottom and avoid excessive vibration and impacts. Doing so may damage the internal parts and result in malfunctions.
- Do not transport the projector with the adjustable feet extended. Doing so may damage the adjustable feet.

Cautions when installing

■ Do not set up the projector outdoors.

- The projector is designed for indoor use only.

■ Do not use under the following conditions.

- Places where vibration and impacts occur such as in a car or vehicle: Doing so may damage the internal parts and result in malfunctions.
- Near the exhaust of an air conditioner or near lights (studio lamps, etc.) where temperature changes greatly (Operating environment ►page 78): Doing so may shorten the life of the lamp or result in deformation of the outer case and malfunctions.
- Near high-voltage power lines or near motors: Doing so may interfere with the operation of the projector.

■ Be sure to ask authorized personnel or your supplier when mounting the product to a ceiling or wall.

This requires an optional ceiling mount bracket.

Model No.: ET-PKV100H (for high ceilings), ET-PKV100S (for low ceilings),
ET-PKC100B (Projector Mount Base), ET-PKC100W (Wall Mount Bracket).

■ When using the projector in the elevation of below 1 000 m, make sure [Fan control] is set to [Off].

Failure to do so may shorten the life of the internal parts and result in malfunctions.

■ When using the projector in the elevation of above 1 000 m and below 2 000 m, make sure [Fan control] is set to [On 1].

Failure to do so may shorten the life of the internal parts and result in malfunctions.

■ When using the projector in the elevation of above 2 000 m and below 2 700 m, make sure [Fan control] is set to [On 2].

Failure to do so may shorten the life of the internal parts and result in malfunctions.

■ Do not install the projector at elevations of 2 700 m (8 858 ft) or higher above sea level.

Failure to do so may shorten the life of the internal parts and result in malfunctions.

■ Cautions when setting the projectors

- Do not stack the projectors.
- Do not block the ventilation ports (intake and exhaust) of the projector.
- Avoid heating and cooling air from the air conditioning system directly blow to the ventilation ports (intake and exhaust) of the projector.

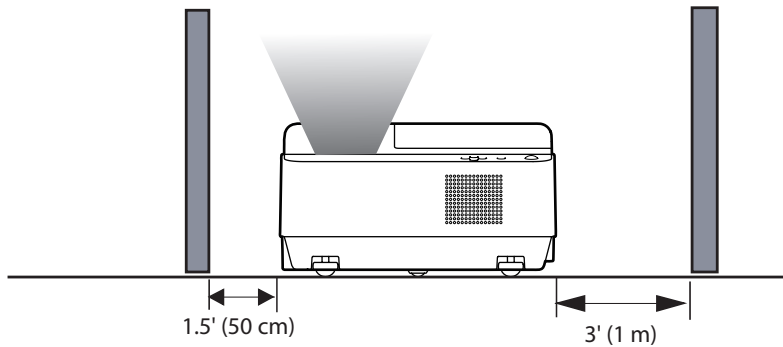

- Do not place the projector in an enclosed space.
If you need to place the projector in an enclosed space, additional air conditioning and ventilation system must be equipped. When ventilation is insufficient, remaining heat may trigger the protection circuit of the projector.

Security

■ Take safety measures against following incidents.

- Personal information being leaked via this product.
- Unauthorized operation of this product by a malicious third party.
- Interfering or stopping of this product by a malicious third party.

■ Security instruction (➔page 57)

- Make your password as difficult to guess as possible.
- Change your password periodically.
- Panasonic or its affiliate company never inquires a password directly to a customer. Do not tell your password in case you receive such an inquiry.
- The connecting network must be secured by firewall or others.
- Set a password and restrict the users who can log in.

Disposal

When disposing of the product, ask your local authority or dealer about the correct methods of disposal. The lamp contains mercury. When disposing of the used lamp unit, ask your nearest local authorities or dealer about proper disposal of the unit. Dispose of used batteries according to the instructions or your local disposal rule or guidelines.

Cautions on use

■ In order to get the picture quality

- Draw curtains or blinds over windows and turn off any lights near the screen to prevent outside light or light from indoor lamps from shining onto the screen.
- Depending on where the projector is used, heated air from an exhaust port or warm or cold air from an air conditioner can cause a shimmering effect on screen.
Avoid use in locations where exhaust or streams of air from projector, other devices and air conditioners flow between the projector and the screen.
- The lens of projector is affected by the heat from the luminous source. Because of this, the focusing may not be stable right after the power is turned on. Focusing is stabilized after projecting image for 30 minutes and longer.

■ Do not touch the surface of the projection window with your bare hand.

If the surface of the projection window becomes dirty from fingerprints or anything else, this will be magnified and projected onto the screen.

■ DLP chips

- The DLP chips are precision-made. Note that in rare cases, pixels of high precision could be missing or always lit, but this is not a malfunction.
- Directing a high power laser beam onto the projection window surface can damage the DMD element.

■ Optical components

Operating the projector in an environment with high temperature or heavy exposure to dust or tobacco smoke will reduce the service life of the optical components and may necessitate their replacement within less than one year of use. For details, consult your dealer.

■ Lamp

The luminous source of the projector is a mercury lamp with high internal pressure.

A high pressure mercury lamp has following characteristics.

- The brightness of the lamp will decrease by duration of usage.
- The lamp may burst with sound or shorten life by shock or chipping.
- The life of the lamp varies greatly depending on individual specificities and usage conditions. In particular, continuous use over 22 hours and frequent on/off switching of the power greatly deteriorate the lamp and affect the lamp life.
- In rare cases, the lamp burst shortly after the projection.
- The risk of bursting increases when the lamp is used beyond its replacement cycle. Make sure to replace the lamp unit consistently. ("When to replace the lamp unit" (► page 64))
- If the lamp bursts, gas contained inside of the lamp is released in a form of smoke.
- It is recommended to store replacement lamps for contingency.
- It is recommended to have authorized engineer or your dealer replace the lamp unit.

■ Viewing 3D pictures

Caution for properly viewing 3D pictures:

- The optimum 3D viewing distance from the screen is about 3 m or more and your eyes should be level with the screen.
- Viewing 3D images for an extended period of time or viewing them from an oblique angle can cause eye strain.
- Take breaks when viewing 3D images for an extended period of time. As this may cause eye fatigue.
- Some image sources can cause pseudoscopic image problem. Check the 3D settings to get the 3D effect.
- If the right-eye image and left-eye image are switched, you may not get the 3D effect, resulting in eye strain or nausea.
- There are differences in 3D visual perception between individuals.
- If you get double vision or don't get the 3D effect, discontinue using the projector.
- If you experience fatigue or nausea, stop using the projector.
- After viewing the rotating, swinging, or jumping 3D images, you may experience 3D motion sickness.
- If you experience such symptom, immediately stop viewing the 3D images and take a break until the symptom has subsided.

Precautions for Use

- If you view 3D images in bright ambient light environment, you may not be able to see them clearly. Or if you use the 3D glasses in a room with fluorescent lighting (50Hz), flickering may occur. If these happen, change the room lighting condition by making the room dark or turning off the light.

Restrictions on viewing 3D images:

- Children who are six years of age or younger should not view 3D images.
- Parents should accompany and monitor their children as children cannot properly express discomfort with 3D image viewing.
- Photosensitive patients, patients with heart disease, pregnant women, elderly people, and people with serious illness and/or with a history of epilepsy should not view 3D images.
- We advise that you should refrain from viewing 3D images if you are in bad physical condition.
- We do not recommend viewing 3D images if you need sleep or have been drinking alcohol.

Pursuant to the directive 2004/108/EC, article 9(2)

Panasonic Testing Centre

Panasonic Service Europe, a division of Panasonic Marketing Europe GmbH

Winsbergring 15, 22525 Hamburg, F.R. Germany

Precautions for Use

Accessories

Make sure the following accessories are provided with your projector. Numbers in the brackets () show the number of accessories.

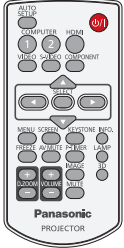
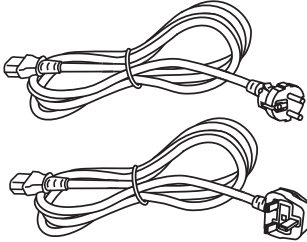
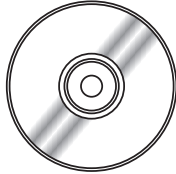
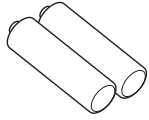
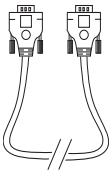
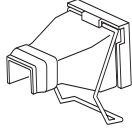
Remote control unit (x1) (6451054586)	Power cord (x1) (6103597768) (6103597775)	CD-ROM (x1) (6103615875)	Batteries (AAA/R03 or AAA/LR03 type) (x2)
			 (for remote control unit)
RGB signal cable (x1) (6103580425)	AC power cord holder (x1) (6103573700) (6103595221)		
			

Attention

- After unpacking the projector, discard the power cord cap and packaging material properly.
- For lost accessories, consult your dealer.
- The part numbers of accessories and separately sold components are subject to change without notice.
- Store small parts in an appropriate manner, and keep them away from young children.

Contents of the supplied CD-ROM

The contents of the supplied CD-ROM are as follow.

[●: Instructions/List (PDF)]

- Operating Instructions – Projector Operations
- Operating Instructions – Network Operations

Optional accessories

Options	Model No.
Ceiling Mount Bracket	ET-PKV100H (for high ceilings), ET-PKV100S (for low ceilings)
Projector Mount Base	ET-PKC100B
Wall Mount Bracket	ET-PKC100W
Replacement Lamp Unit	ET-LAC100
Replacement Filter Unit	ET-RFC100

About Your Projector

Remote control

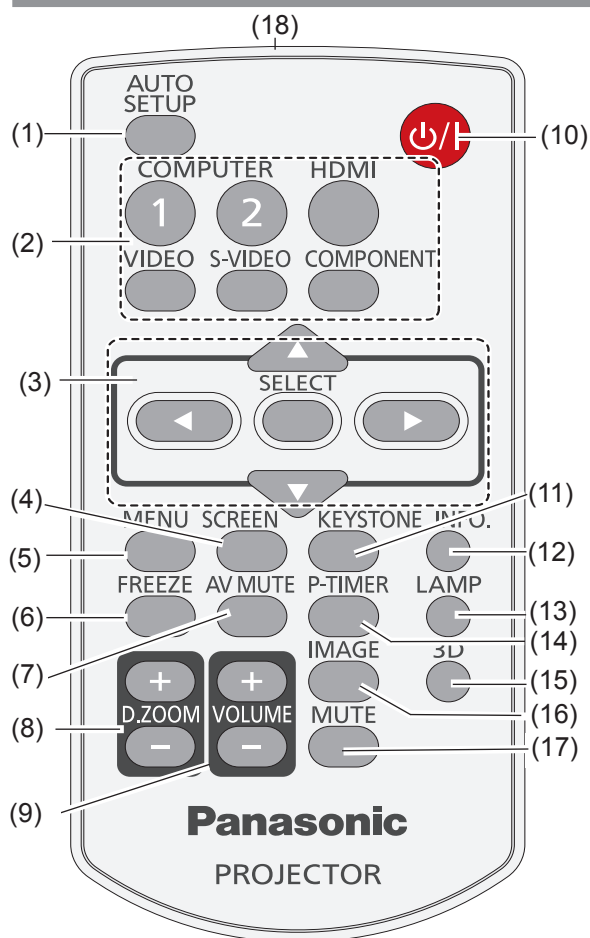

(1) <AUTO SETUP> Button

Execute the setting of Auto setup in the setting menu. (➔page 53)

(2) Input Selection Buttons: <COMPUTER 1>, <COMPUTER 2>, <HDMI>, <VIDEO>, <S-VIDEO>, <COMPONENT>.

These buttons are used to select the input signal. (➔page 33)

(3) ▲ ▼ ◀ ▶ Buttons, <SELECT> Button

Navigate the MENU display. (➔page 37)

(4) <SCREEN> Button

Select a screen mode. (➔page 49)

(5) <MENU> Button

Open or close the On-Screen Menu. (➔page 37)

(6) <FREEZE> Button

Pause the projected image and sound tentatively. (➔page 34)

(7) <AV MUTE> Button

Temporarily turn off the image on the screen. (➔page 35)

(8) <D.ZOOM +/-> Buttons

Zoom in and out the images.(➔page 33)

(9) <VOLUME +/-> Buttons

Adjust the volume of the speaker. (➔page 35)

(10) <⏻/⏻> Button

Turn the projector on or off. (➔page 28)

(11) <KEYSTONE> Button

Correct keystone distortion. (➔page 34)

(12) <INFO.> Button

Operate the information function. (➔page 34)

(13) <LAMP> Button

Select a lamp mode. (➔page 35)

(14) <P-TIMER> Button

Operate the P-timer function. (➔page 35)

(15) <3D> Button

Operate the 3D function. (➔page 36)

(16) <IMAGE> Button

Select the image mode. (➔page 35)

(17) <MUTE> Button

Mute the sound. (➔page 36)

(18) Remote control signal emitter

Attention

- Do not drop the remote control.
- Avoid contact with liquids.
- Do not attempt to modify or disassemble the remote control.

Note

- If there are any obstacles between the remote control and the remote control signal receptor, the remote control may not operate correctly.
- You can operate the projector by reflecting the remote control signal on the screen. The operating range may differ due to the loss of light caused by the properties of the screen.
- When the remote control signal receptor is lit with a fluorescent light or other strong light source, the projector may become inoperative. Set the projector as far from the luminous source as possible.
- Point the remote control toward the projector (remote control signal receptor) when pressing the buttons. See the below figures indicating Maximum operating range for the remote control.

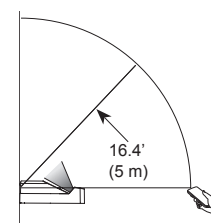
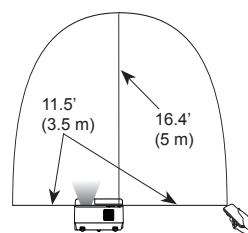

About Your Projector

Projector body

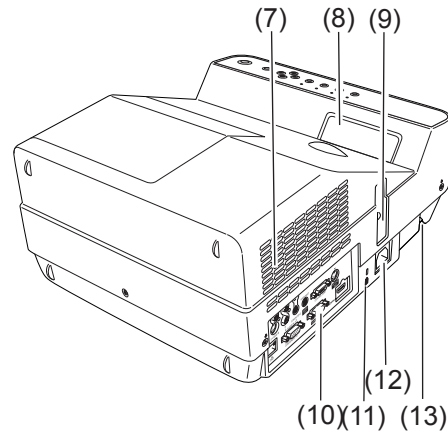
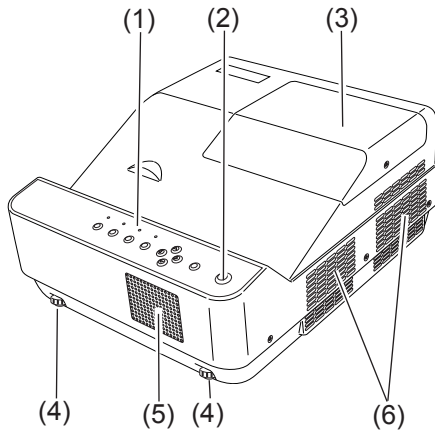

(1) **Control Panel and Indicators** (➔page 19)

(2) **Remote control signal receptor**

(3) **Lamp cover (Lamp and Air Filter)** (➔page 65)

The lamp unit and filter unit are located inside.

(4) **Adjustable feet**

Adjust the projection angle.

(5) **Speaker**

(6) **Air exhaust port**

Hot air is exhausted from the air exhaust port. Do not put heat-sensitive objects near this side.

(7) **Air intake port**

(8) **Projection Window**

(9) **Focus Lever**

Adjust the focus.

(10) **Terminals and Connectors** (➔page 19)

(11) **Kensington Security Slot**

This slot is for a Kensington lock used to deter theft of the projector.

* *Kensington is a registered trademark of ACCO Brands Corporation.*

(12) **AC IN**

(13) **Security Bar**

WARNING:

■ **Keep your hands and other objects away from the air exhaust port.**

- Keep your hand and face away.
- Do not insert your finger.
- Keep heat-sensitive articles away.

Heated air from the air exhaust port can cause burns or external damage.

Control panel

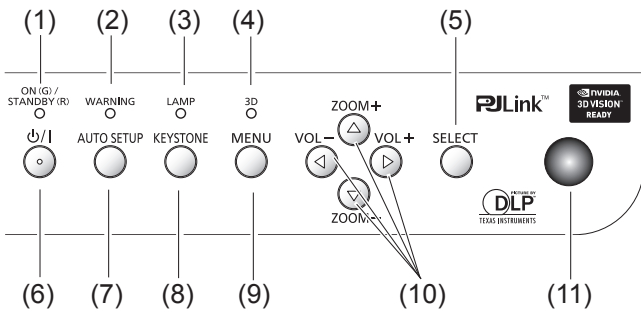

(1) <ON(G)/STANDBY(R)> indicator

Indicate the power status.

(2) <WARNING> indicator

Indicate the abnormal conditions of the projector.

(3) <LAMP> indicator

Light yellow when the projection lamp reaches its end of life.

(4) <3D> indicator

Turn blue when the projector is in 3D mode. (➔page 32)

(5) <SELECT> button

Execute the selected item.

(6) <ON/OFF> button

Turn the projector on/off.

(7) <AUTO SETUP> button

Execute the setting of Auto setup in the setting menu. (➔page 33)

(8) <KEystone> button

Correct keystone distortion. (➔page 34)

(9) <MENU> button

Displays the MENU screen. (➔page 37)

(10) ▲ ▼ (ZOOM -/+)/◀▶ (VOL -/+) buttons

Navigate the MENU screen.

Adjust the volume level (with <VOL -/+> buttons). (➔page 35)

(11) Remote control signal receptor

The protruding shape allows wide-angle remote control signal reception.

Side terminals

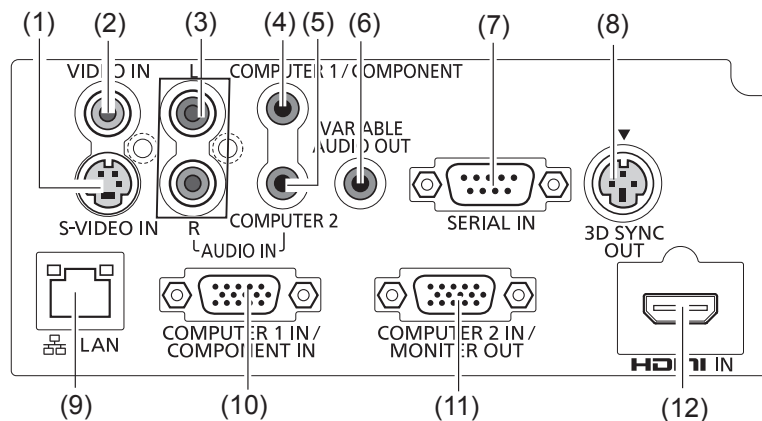

(1) S-VIDEO IN

Connect to S-VIDEO output signals.

(2) VIDEO IN

Connect to VIDEO output signals.

(3) AUDIO IN

Connect to the audio output signals. AUDIO IN has right and left (L and R) terminals.

(4) COMPUTER 1/COMPONENT AUDIO IN

Connect the audio input signals.

(5) COMPUTER 2 AUDIO IN

Connect to the audio input signals.

(6) AUDIO OUT (VARIABLE)

Output the audio signals input to the projector.

(7) SERIAL IN

Connect to a computer via an RS-232C cable.

(8) 3D SYNC OUT

Connect a 3D sync. signal cable for an IR wireless emitter to this jack.

(9) LAN

Connect to a LAN cable for network connection.

(10) COMPUTER 1 IN/ COMPONENT IN

Connect to COMPUTER 1 IN/ COMPONENT IN input signals.

(11) COMPUTER 2 IN/ MONITOR OUT

Connect to COMPUTER 2 IN/ MONITOR OUT input signals or outputs the analog RGB signals input the projector.

(12) HDMI IN

Connect to HDMI input signals.

Attention

- When a LAN cable is directly connected to the projector, the network connection must be made indoors.

Using Remote control

Installing and Removing batteries

1) Open the cover

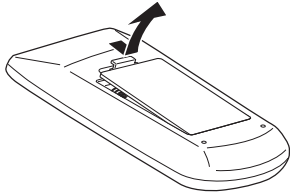

2) Install batteries and close the cover (Insert the – side first.)

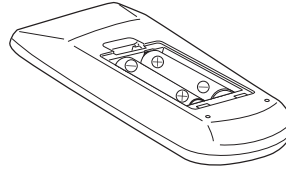

- Remove the batteries in the reverse order of installation.

Setting Remote control ID numbers

When you use the system with multiple projectors, you can operate each projector individually using single remote control, if unique ID number is assigned to each projector.

After setting the ID number of the projector, set the same ID number to the remote control.

There are 2 different ID codes (Code 1 and Code 2), the initial ID number is [Code 1].

■ Setting the ID number

Press and hold both the MENU and IMAGE buttons together for 5 seconds or more. After changing the code, make sure the remote control operates properly.

Note

- For details, please refer to the [Remote control] of the [Setting] menu. (▶ page 57)
- This remote control is only for PT-CW230EA and PT-CX200EA. You cannot operate the other Panasonic projectors by using this remote control.

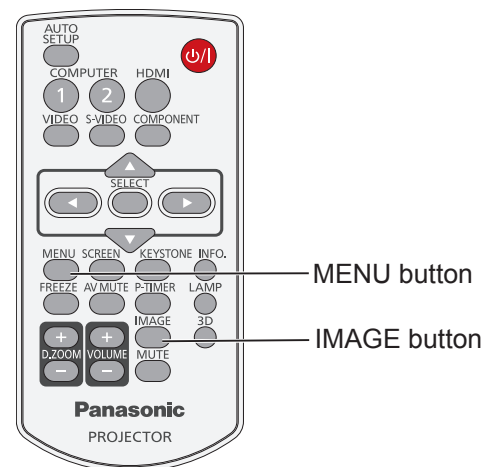

Setting up

Projection method

You can use the projector with any of the following 6 projection methods. To set the desired method in the projector.



Attention

- For optimum viewing quality, install the projector in a location where screen exposure to outside light, light from light fixtures or other light is at a minimum. Also draw the curtains, close blinds and turn off light fixtures.
- Do not roll the projector more than 10 degrees from side to side.
- Do not roll the projector more than 5 degrees from side to side when front or rear is downward.

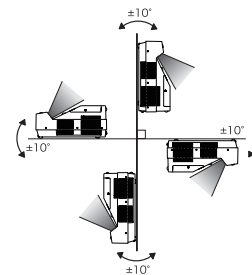
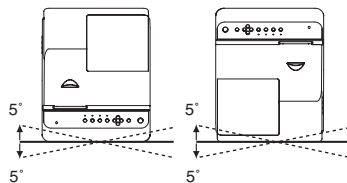
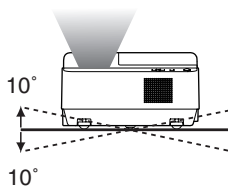

Parts for ceiling or wall mount (Optional)

You can install the projector on the ceiling or wall by using the optional ceiling mount bracket (ET-PKV100H: for high ceiling, ET-PKV100S: for low ceiling), the optional projector mount base ET-PKC100B, and Wall Mount Bracket ET-PKC100W.

- Use only the ceiling mount brackets or Wall Mount Bracket specified for this projector.
- Refer to the installation manual for the ceiling mount bracket or Wall Mount Bracket when you install the bracket or hanger and the projector.

Attention

- To ensure projector performance and security, installation of the ceiling mount bracket or Wall Mount Bracket must be carried by your dealer or a qualified technician.

Setting up

Screen size and throw distance

Place the projector referring to the diagram on the right and the figures of throwing distance. You can adjust the display size.

L	Projection distance (cm)
SH	Height of the projection area (m)
SW	Width of the projection area (m)
SD	Diagonal length of the projection area (m)
A	Height from bottom of projector to bottom of screen (cm)

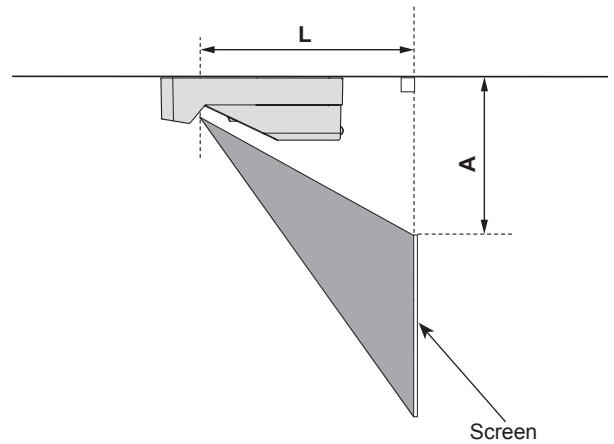

Attention

- Before installing, please read "Precautions for Use" (➡ pages 12 to 16).
- Special care should be used when DLP projectors are used in the same room as high power laser equipment. Direct or indirect hitting of a laser beam on to the lens can severely damage the DMD element in which case there is a loss of warranty.

Note

- When projecting to wall or flat objects, even slight warpage or irregularities of the screen may have an effect on the quality of the projected images.

■ Projection distance for PT-CW230EA

(All measurements below are approximate and may differ slightly from the actual measurements.)

Projection size	For 4:3 aspect ratio		For 16:9 aspect ratio		For 16:10 aspect ratio	
	L	A	L	A	L	A
1.40 m(55")	24.0 cm(0.79')	22.9 cm(0.75')	-	-	-	-
1.52 m(60")	26.5 cm(0.87')	24.1 cm(0.79')	23.7 cm(0.78')	27.0 cm(0.89')	23.0 cm(0.75')	22.5 cm(0.74')
1.78 m(70")	31.6 cm(1.04')	26.4 cm(0.87')	28.4 cm(0.93')	29.7 cm(0.97')	27.5 cm(0.90')	24.5 cm(0.80')
2.03 m(80")	36.7 cm(1.20')	28.6 cm(0.94')	33.0 cm(1.08')	32.5 cm(1.07')	32.0 cm(1.05')	26.5 cm(0.87')
2.29 m(90")	41.8 cm(1.37')	30.9 cm(1.01')	37.6 cm(1.23')	35.3 cm(1.16')	36.5 cm(1.02')	28.5 cm(0.94')
2.54 m(100")	-	-	42.2 cm(1.39')	38.0 cm(1.25')	41.0 cm(1.35')	30.5 cm(1.00')
2.79 m(110")	-	-	-	-	45.5 cm(1.49')	32.5 cm(1.07')

* Install the projector where the projection distance should be within 23.0 cm and 45.5 cm in order to keep the lens performance.

Any other projection distance can be obtained according to the screen dimensions (m) using the following calculations.

The distance is shown in units of meters. (The calculated distance may contain a certain error.)

If the screen dimensions are written as "SD",

	For 4:3 aspect ratio	For 16:9 aspect ratio	For 16:10 aspect ratio
Screen height (SH)	= SD(m) × 0.6	= SD(m) × 0.490	= SD(m) × 0.530
Screen width (SW)	= SD(m) × 0.8	= SD(m) × 0.872	= SD(m) × 0.848
Projection distance (L)	= 0.200425 × SD(m) - 0.039967	= 0.18196 × SD(m) - 0.039967	= 0.1770 × SD(m) - 0.039967

■ Projection distance for PT-CX200EA

(All measurements below are approximate and may differ slightly from the actual measurements.)

Projection size	For 4:3 aspect ratio		For 16:9 aspect ratio	
	L	A	L	A
1.27 m(50")	-	-	24.8 cm(0.81')	35.5 cm(1.17')
1.40 m(55")	25.1 cm(0.82')	25.2 cm(0.83')	27.7 cm(0.91')	38.0 cm(1.25')
1.52 m(60")	27.7 cm(0.91')	26.6 cm(0.87')	30.6 cm(1.00')	40.5 cm(1.33')
1.78 m(70")	33.0 cm(1.08')	29.3 cm(0.96')	36.4 cm(1.19')	45.5 cm(1.49')
2.03 m(80")	38.3 cm(1.26')	31.9 cm(1.05')	42.1 cm(1.38')	50.5 cm(1.66')
2.29 m(90")	43.7 cm(1.43')	34.6 cm(1.14')	-	-

* Install the projector where the projection distance should be within 23.0 cm and 45.5 cm in order to keep the lens performance.

Any other projection distance can be obtained according to the screen dimensions (m) using the following calculations.

The distance is shown in units of meters. (The calculated distance may contain a certain error.)

If the screen dimensions are written as "SD",

	For 4:3 aspect ratio	For 16:9 aspect ratio
Screen height (SH)	= SD(m) × 0.6	= SD(m) × 0.490
Screen width (SW)	= SD(m) × 0.8	= SD(m) × 0.872
Projection distance (L)	= 0.2092 × SD(m) - 0.041703	= 0.227909 × SD(m) - 0.041703

Setting up

Adjusting front adjustable feet

Lift the front of the projector and rotate the adjustable feet to a proper height and tilt.

You can turn the front adjustable feet to extend them. You can turn them in the opposite direction to contract them.

(You can adjust the projection angle vertically.)

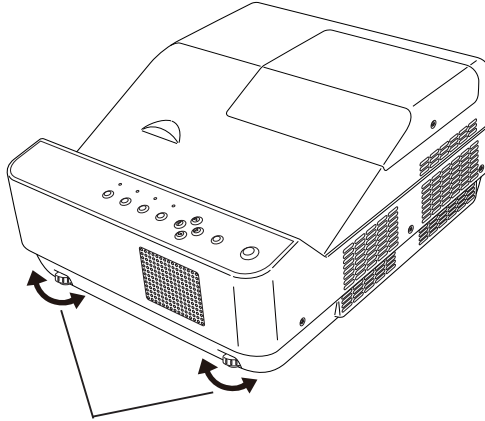

Adjustable range: 1.0 degree

Attention

- Heated air comes out of the air exhaust port while the lamp is lit. Do not touch the air exhaust port directly when you adjust the front adjustable feet.
- If keystone distortion occurs on the projected image, perform "KEYSTONE" from the "Screen" menu. (► page 50)

Note

- Screw up the adjustable feet, and an audible click will be heard as the limit.

Connections

Before connecting to the projector

- Read carefully the instruction manual for the device to be connected.
- Turn off the power switch of the devices before connecting cables.
- If any connection cable is not supplied with the device, or if no optional cable is available for connection of the device, prepare a necessary system connection cable to suit the device.
- Video signals containing too much jitter may cause the images on the screen to randomly wobble or wafture. In this case, a time base corrector (TBC) must be connected.
- The projector accepts the following signals: VIDEO, S-VIDEO, analogue-RGB (with TTL sync. Level) and digital signal.
- Some computer models are not compatible with the projector.
- When using long cables to connect with each of equipment to the projector, there is a possibility that the image will not be output correctly unless a compensator is used.
- For details on what video signals the projector supports, see “List of compatible signals”. (▶ pages 73-76)

Connecting example

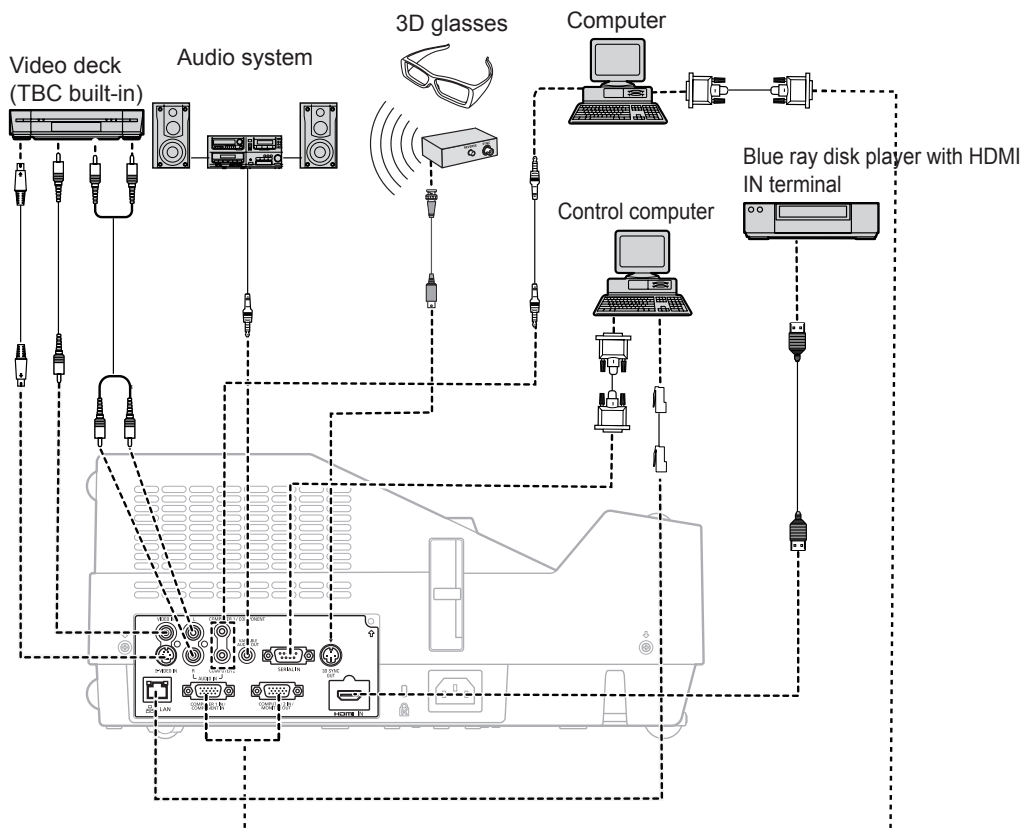

Attention

- When connecting with a video deck, be sure to use the one with a built-in time base corrector (TBC) or use a TBC between the projector and the video deck.
- If nonstandard burst signals are connected, the image may be distorted. If this is the case, connect a TBC between the projector and the video deck.

Note

- When using an HDMI cable, check that it is compliant with the HDMI standard. Using a cable that is not compliant with the HDMI standard may result in problems such as the image cutting out or not appearing. When connecting the 1 080p signal using HDMI, use a cable compliant with 1 080p signal.
- This projector does not support the Viera link (HDMI).
- For the specifications of the RGB signals that can be applied from the PC, refer to “List of compatible signals”. (▶ pages 73-76)
- See “Network operation” in the instruction manual on the supplied CD-ROM for the details of wired LAN communication between the projector and the computer.

Powering ON/OFF

Connecting the power cord

Be sure to insert the attached power cord securely to its base to prevent it from coming off.

■ Power cord holder

A power cord holder is designed to prevent the AC power cord from coming off the projector. Please insert the power cord into the power cord holder correctly as Picture (1) shown:

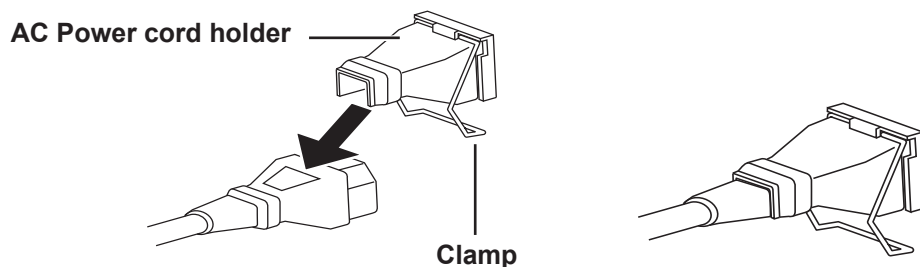

Picture (1)

■ Attaching

Attach the AC power cord with the power cord clamp to the projector by following these steps.

- 1) Plug the power cord with the power cord holder to the projector as Picture (2) shown.
- 2) Push the clamp at the AC Power cord holder downward to secure it to the projector. It is correctly attached until you hear the "CLICK" sound. See Picture (3) for correct attachment.

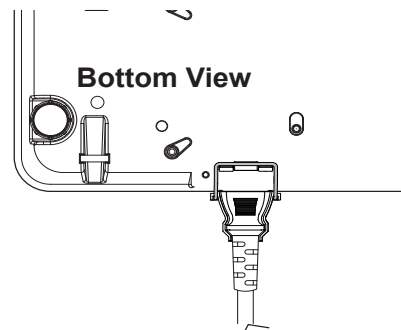
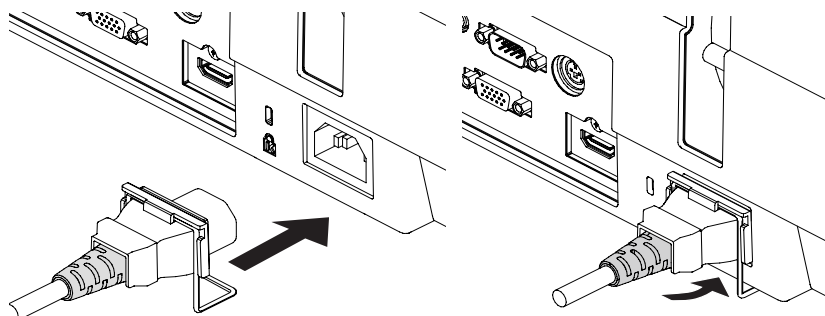

ON(G)/STANDBY(R) indicator

The <ON(G)/STANDBY(R)> indicator informs you the status of the power. Confirm the status of the <ON(G)/STANDBY(R)> indicator before operating the projector.

ON(G)/STANDBY(R) indicator

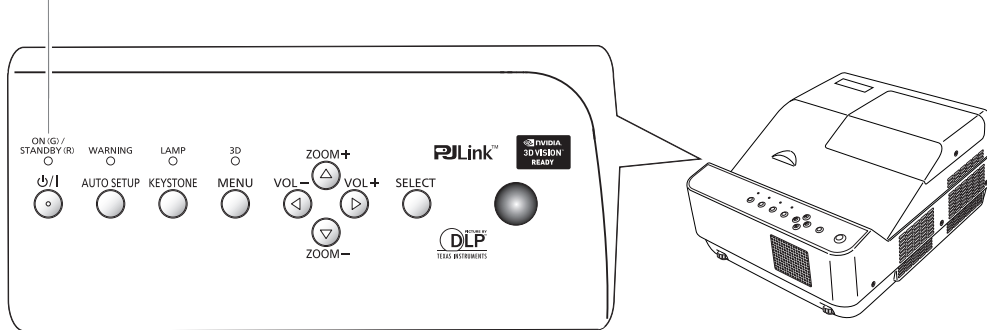

Indicator status		Status
No illumination or flashing		The power cord is unplugged.
RED	Lit	The power cord is plugged. The projector is in stand-by mode, after the cooling is completed.
	Flashing	The projector is cooling down. The projector cannot be turned on until cooling is completed and the <ON(G)/STANDBY(R)> indicator stops blinking. The temperature inside the projector is abnormally high and the projector is cooling down. And the <WARNING> indicator also blinks in red (➡page 61). The projector cannot be turned on until cooling is completed and the <ON(G)/STANDBY(R)> indicator stops blinking.
GREEN	Lit	Projecting.
	Flashing	The projector is in stand-by status with [Power management] function. The projection lamp will be turned on if the input signal is reconnected or any button on the control panel or remote control is pressed. (➡page 56)

Powering ON/OFF

Turning On the Projector

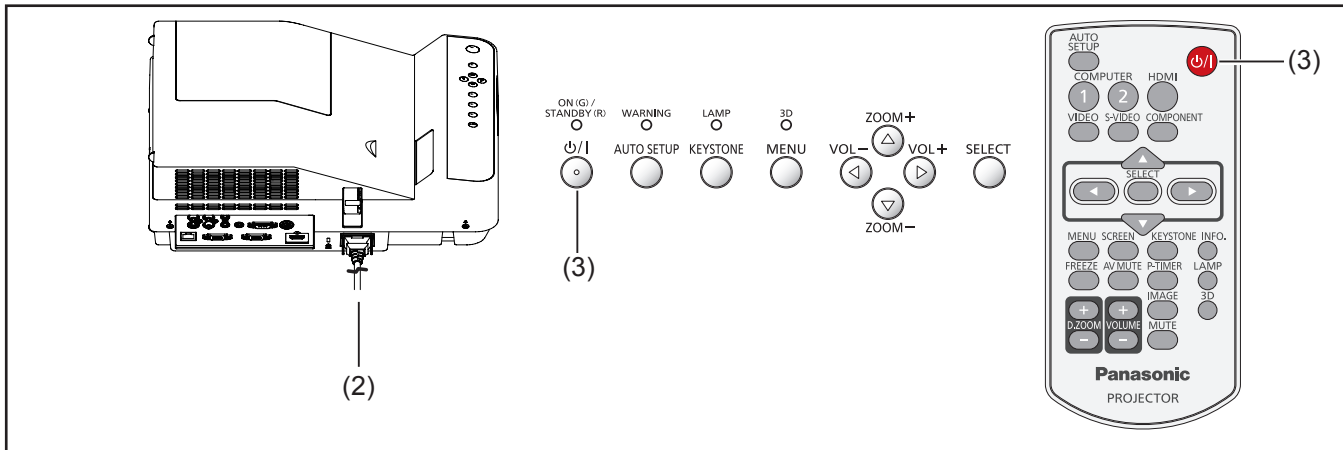

- 1) Complete peripheral connections (with a computer, VCR, etc.) before turning on the projector.
- 2) Connect the projector's AC power cord into an AC outlet. The <ON(G)/STANDBY(R)> indicator lights red.
- 3) Press the <P> button on the control panel or the remote control. The <ON(G)/STANDBY(R)> indicator lights green and the cooling fans start to operate. The preparation display appears on the screen and the count down starts.
- 4) After the countdown, the input source that was selected the last time and the lamp power status icon appear on the screen.
- 5) If there is no signal input when start on the projector, or the current signal is missed while operating the projector, the Video/Computer selection window will be displayed on the screen, please move the pointer to input source desired by pressing the ▲▼ and the <SELECT> button. And then follow the input signal guidance window to correct the signal and connection.

Preparation display

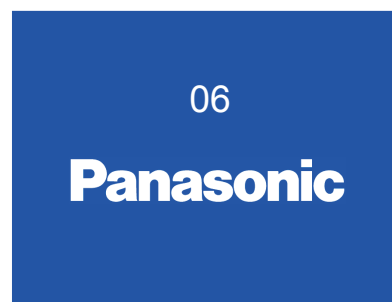

The preparation display will disappear after 30 seconds.

Initial display



Video/Computer selection

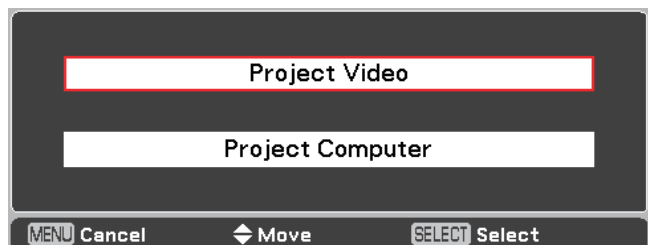

If the projector is locked with a PIN code, PIN code input dialog box will appear. Enter the PIN code as instructed on the next page.

Note

- When the [Logo select] function is set to [Off], the logo will not be shown on the screen (➡ page 55).
- When [Countdown off] or [Off] is selected in the [Display] function, the preparation display will not be shown on the screen (➡ page 54).
- When the [Input search] function is set to [On 2], the input signal will be searched automatically (➡ page 53).
- When the [Direct on] function is set to [On], the projector will be turned on automatically by connecting the AC power cord to an AC outlet.

Enter a PIN code

Press ▲▼ to enter a number. Press ► to fix the number and move the red frame pointer to the next box. The number changes to *. If you fixed an incorrect number, use the ◀ button to move the pointer to the number you want to correct, and then enter the correct number.

Repeat this step to complete entering a four-digit number.

After entering the four-digit number, move the pointer to "Set". Press the <SELECT> button so that you can start to operate the projector.

If you entered an incorrect PIN code, PIN code and the number (****) will turn red for a moment. Enter the correct PIN code all over again.

Note

- If the PIN code number is not entered or wrong PIN code number is entered within three minutes after the PIN code dialog box appeared, the projector will be turned off automatically.
- The "1234" is set as the initial PIN code at the factory.

PIN Code Input Dialog Box

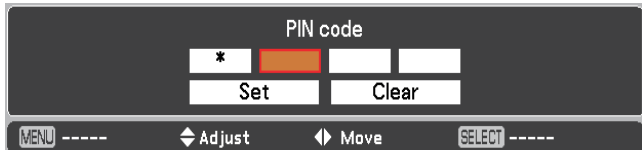

After the OK icon disappears, you can operate the projector.

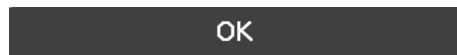

Powering ON/OFF

Turning Off the Projector

- 1) Press the <|/⏻> button on the control panel or the remote control, and **Power off?** appears on the screen.
- 2) Press the <|/⏻> button on the control panel or the remote control again to turn off the projector. The <ON(G)/STANDBY(R)> indicator starts to blink red, and the cooling fans keep running. At this time, you can unplug the AC power cord even if the fans are still running.
- 3) When the projector has cooled down enough, the <ON(G)/STANDBY(R)> indicator stops blinking and you can turn on the projector.

Power off ?

Power off? disappears after 4 seconds.

Note

- Do not put the projector in a case before the projector is cooled enough.
- While the <ON(G)/STANDBY(R)> indicator is blinking, the lamp is being cooled down and the projector cannot be turned on. Wait until the <ON(G)/STANDBY(R)> indicator stops blinking to turn on the projector again.
- The projector can be turned on after the <ON(G)/STANDBY(R)> indicator turns red. The waiting time to restart will be shortened when the normal power-off processing for fan cooling is completed, compared with the time the AC power cord is immediately unplugged after the power-off.
- To protect the component parts inside the projector, the fans normally start running again in approximately 40 seconds after turning off the projector. This is NORMAL operation and not a malfunction.

■ Direct Power Off function

You can disconnect the power cord from the wall outlet or turn off the breaker even during projection without pressing the <|/⏻> button.

Note

- When using the Direct power Off function, you can not restart the projector immediately after the power is disconnected. The lamp remains high temperature and needs to be cooled, so it sometimes takes longer time than usual for the lamp to light up again.

Projecting

Check the connections of the peripheral devices and connection of the power cord (➡page 26) and switch on the power (➡page 28) to start the projector. Select the image and adjust the state of the image.

Selecting the image

Select an input signal.

The image selected with the <COMPUTER 1>, <COMPUTER 2>, <HDMI>, <VIDEO>, <S-VIDEO>, or <COMPONENT> button is projected (➡pages 40-41).

Attention

- Images may not be projected properly depending on the connected device and DVD, video tape, etc. to be played. Set a system format that is suitable for the input signal in [Component], [S-video] and [Video] in the [Input] menu (➡page 40).
- Check the aspect ratio of the screen and the image and select the optimum aspect ratio under the [Screen] menu (➡page 49).

How to adjust the state of the image

Zoom and Image Position Adjustment

Press the ZOOM +/- buttons on the control panel to adjust the screen size. Screen size can be adjusted 84% to 100% from its maximum screen size.

It is not available when On-Screen menu is displayed.

Zoom adjustment can be memorized (➡page 54).

The image position can be adjusted in the Zoom Adjustment by the following steps:

- 1) Press the ZOOM+ or ZOOM- button on the control panel.
- 2) While ZOOM+ or ZOOM- is displayed on the screen, press the <SELECT> button. Arrow marks displayed on the screen.
- 3) Press ▲▼◀▶ buttons on the control panel or the remote control to adjust the image position.

Note:

- Zoom and Image Position Adjustment can not be operated when 4:3 or 16:9 mode is selected in the [Screen aspect] menu or [Custom] is selected in the [Screen] menu.
- The image position adjustment can not be adjusted at ZOOM maximum.
- The white arrows indicate that there is no correction.
- A red arrow indicates the direction of correction.
- An arrow disappears at the maximum correction.

Focus Adjustment

- Adjust the lens focus with the focus lever.

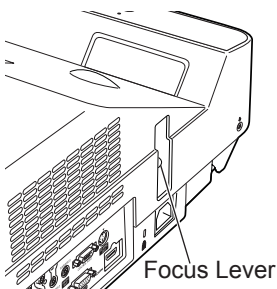

Note

- It is recommended that the images are projected continuously for at least 30 minutes before the focus is adjusted.
- If keystone distortion occurs, see "KEystone". (➡page 50)

For Viewing 3D Contents

To view 3D images, you need to prepare at least the 3D active shutter glasses, 3D content and 3D reproducing equipment. For example, as for computer, when transmitting 3D signals from a computer to the projector, you also need to install the graphic card which has the capability to sequentially output the 3D frames at 120Hz and software in the computer. The 3D signal type which the projector can accept is frame sequential only. Other 3D signal types such as frame packing and side-by-side are not supported.

As for 3D glasses, DLP Link format and IR emitter format are compatible with this projector. Compatibility with any other 3D glasses than the 2 types 3D glasses is not guaranteed.

In a situation of using NVIDIA 3D glasses, NVIDIA IR emitter, and a computer which NVIDIA graphics card is installed, when you want to view NVIDIA-compatible 3D contents, please set to NVIDIA 3D VISION mode.

Attention

- COMPUTER 2 IN/MONITOR OUT terminal is not supported NVIDIA 3D VISION. Please input the image signals to COMPUTER 1 IN/COMPONENT IN or HDMI terminal.

■ Using 3D Glasses with DLP Link compatible

When using DLP Link compatible glasses, follow these steps:

- 1) Turn on the projector and the 3D glasses.
- 2) Wear the 3D glasses and press the 3D button on the remote control to activate 3D Display function. When 3D mode is in On, 3D indicator turns blue.
- 3) If you see a discrete or overlapping image, 3D Sync Invert function enables you to get the correct image. Press the 3D button to switch 3D Sync signal from among "3D Off", "3D (Sync 1)", "3D (Sync 2)" or "3D VISION".

Note

- 3D setting can also be selected from the menu. (➡page 54)

■ Using 3D Glasses with IR wireless emitter

When using IR emitter system, follow these steps:

- 1) Turn off the projector.
- 2) Connect the sync cable for the IR emitter to 3D SYNC OUT terminal of the projector.
- 3) Turn on the projector, the IR emitter and the stereoscopic wireless LCD glasses.
- 4) Wear the 3D glasses and press the 3D button on the remote control to activate 3D Display function.

Note

- If you see a discrete or overlapping image, press the 3D button to switch 3D Sync signal from among "3D Off", "3D (Sync 1)", "3D (Sync 2)" or "3D VISION".
- You can also invert the sync signal by using the switch on the IR emitter.

Attention

- Before viewing 3D contents, please read "Precaution for use". (➡pages 14-15)

Basic operations by using the remote control

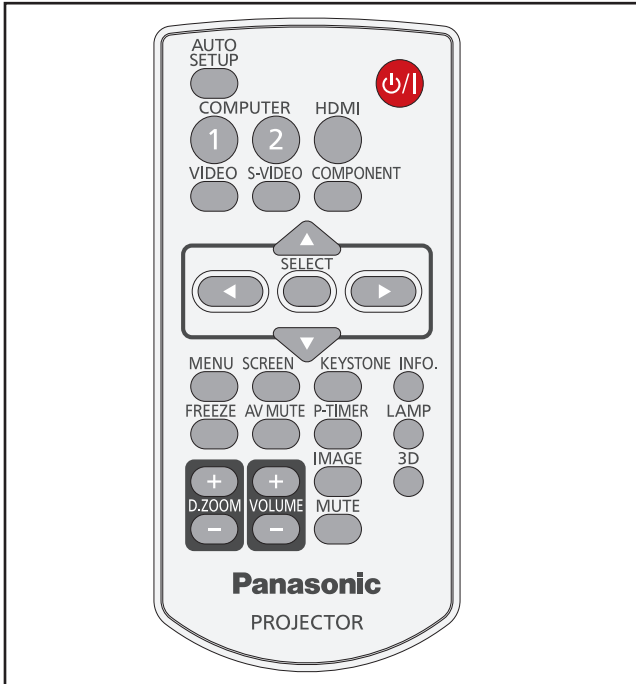

COMPUTER 1	Switch to Computer 1(RGB)/ Computer 1(Scart) input.
COMPUTER 2	Switch to Computer 2(RGB)input.
HDMI	Switch to HDMI input.
VIDEO	Switch to Video input.
S-VIDEO	Switch to S-video input.
COMPONENT	Switch to Computer 1 (Component) input.

Using the AUTO SETUP function

This function allows you to automatically adjust Input search, and Auto PC adjustment during signal input from a computer.



Press the <AUTO SETUP> button on the remote control.

Note

- For details, see "Setting" of Main menu. (➔page 53)

Switching the input signal

You can switch the input signals to project.

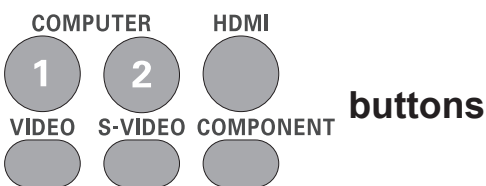

Press (<COMPUTER 1>,<COMPUTER 2>,<HDMI>,<VIDEO>,<S-VIDEO>, or <COMPONENT>) button on the remote control.

Using the SCREEN button

This function allows you to select screen mode or change the screen size.



Press the <SCREEN> button on the remote control.

Note

- For details, see "Screen" of Main menu. (➔page 49)

Basic operations by using the remote control

Using the KEYSTONE button

This function allows you to correct keystone distortion.

KEYSTONE
 **button**

Press the <KEYSTONE> button on the control panel or the remote control. The Keystone dialog box appears. Press ▲▼ to correct keystone distortion. The keystone adjustment can be stored (➔page 50).

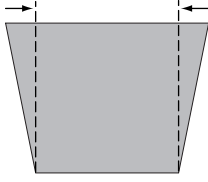
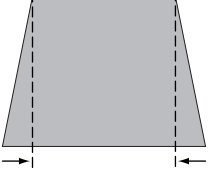
Operation	Screen image
Reduce the upper width with press ▲.	
Reduce the lower width with press ▼.	

Note

- The white arrows indicate that there is no correction.
- A red arrow indicates the direction of correction.
- An arrow disappears at the maximum correction.
- If you press the <KEYSTONE> button on the control panel or the remote control once more while the keystone dialog box is being displayed, the keystone adjustment will be canceled (➔page 50).
- The adjustable range is limited depending on the input signal.

Using the INFO. button

This function allows you to display the information menu.

INFO.
 **button**

Press <INFO.> button on the remote control.

Note

- For details, see “Input Source Information Display” in “Information” under Main menu (➔page 60).

Using the FREEZE function

You can freeze the projected image and stop the sound temporarily, regardless of the playing condition of the connected device.

FREEZE
 **button**

Press the <FREEZE> button on the remote control to freeze the picture on the screen, meanwhile, volume is muted. To cancel the Freeze function, press the <FREEZE> button again or press any other button.

Fig.1 will appear on the screen while the Freeze function is working.

Fig.1



Note

- When no signal inputs,  mark will appear.

Basic operations by using the remote control

Using the AV MUTE function

AV MUTE
 button

Press the <AV MUTE> button on the remote control to black out the image. To restore to normal, press the <AV MUTE> button again or press any button.

- The screen changes each time you press the <AV MUTE> button as follows.



Note

- When use the <MUTE> button to release the [AV mute] function, the mute function can not be operated at the same time.

Using the P-TIMER button

Press the <P-TIMER> button on the remote control to operate the [Count up] function. The Timer display "00 : 00" appears on the screen and starts to count time (00 : 00–59 : 59).

P-TIMER
 button

Press <P-TIMER> button on the remote control.

Note

- To stop the P-timer, press the <P-TIMER> button.
- To cancel the P-timer, press the <P-TIMER> button again.

Using the LAMP button

This function allows you to select the lamp mode for changing the brightness on the screen.

LAMP
 button

Press <LAMP> button on the remote control.

Note

- For details, see "Lamp Power" of "Setting" under Main menu. (➡page 57)

Using the D.ZOOM buttons

This function allows you to enter to the Digital zoom +/- mode.

 buttons

Press <D.ZOOM+/-> buttons on the remote control.

Note

- For details, see "Screen" of Main menu. (➡page 49)

Controlling the volume of the speaker

You can control the volume of the projector's speaker or audio output.

 buttons

Press the <VOLUME+/-> buttons on the control panel or on the remote control to adjust the volume. The volume dialog box appears on the screen for a few seconds.

Note

- For details, see "Volume" of "Sound" under Main menu. (➡page 52)

Using the IMAGE button

This function allows you to select a desired image mode of the screen.

IMAGE
 button

Press <IMAGE> button on the remote control to select the desired image mode among [Dynamic], [Standard], [Real], [Cinema], [Image 1], [Image 2], [Image 3] and [Image 4].

Note

- For details, see "Image select" of Main menu. (➡page 45)

Basic operations by using the remote control

Using the 3D button

This function allows you to operate the 3D function.



Press <3D> button on the remote control.

Note

- For details, see "3D" of "Setting" under Main menu.
(➔page 54)

Using the MUTE button

Press this button on the remote control to select [On] to temporarily turn off the sound.



Press <MUTE> button on the remote control.

Note

- To turn the sound back on, press this button again to select [Off] or press the <VOLUME+/-> buttons.
(➔page 52)

Menu Navigation

Navigating through the menu

Operating procedure

1) Press the <MENU> button.

The Main Menu screen appears.

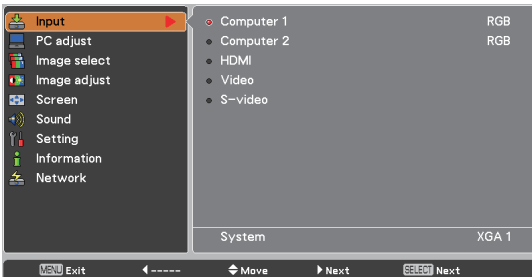

2) Press ▲ ▼ to select the Main Menu item.

Select the desired item from the 9 items: [Input], [PC adjust], [Image select], [Image adjust], [Screen], [Sound], [Setting], [Information] and [Network]. The selected item is highlighted with an orange cursor and the submenu of the selected item appears on the right.

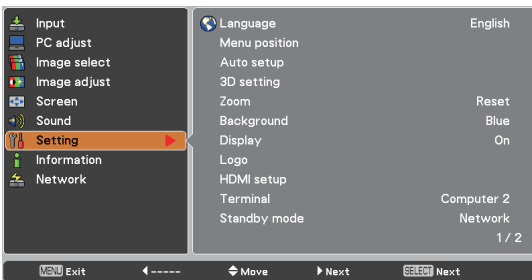

3) Press ► or the <SELECT> button.

The submenu appears so that you can select the sub-menu item.

4) Press ▲ ▼ to select the desired sub-menu item.

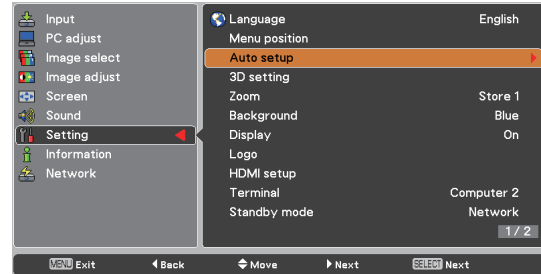

5) Press the <SELECT> button or press ► to enter the desired item.

6) Press ▲ ▼ ◀ ▶ to set or adjust the parameter values.

7) Press ◀ to return the previous menu. Press the <MENU> button to exit the menu display.

Note









- Some items may not be adjusted or used for certain signal formats input to the projector. The MENU items that cannot be adjusted or used are shown in gray characters, and they cannot be selected.
- Some items can be adjusted even if signals are not input.
- See pages 38 and 39 for details on the items of submenu.

Menu Navigation

Main menu

The main menu consists of the following 9 menu items.

When a main menu item is selected, the screen changes to a submenu selection screen.

	Input
	PC adjust
	Image select
	Image adjust
	Screen
	Sound
	Setting
	Information
	Network

Sub menu

The sub-menu screen of the selected main menu appears, and you can set and adjust the various items in the submenu.

Input []

Sub-menu item	Factory default	Page
Computer 1	RGB	40
Computer 2	RGB	40
HDMI	-	41
Video	-	41
S-video	-	41

PC adjust []

Sub-menu item	Factory default	Page
AUTO PC adj.	-	42
Fine sync.	-	43
Total dots	-	43
Horizontal	-	43
Vertical	-	43
Current mode	-	44
Clamp	-	44
Reset	-	44
Mode free	-	44
Store	-	44

Note

- This function will be available when the input source come from computer.

Image select []

Sub-menu item	Factory default	Page
Dynamic	-	45
Standard	-	45
Real	-	45
Cinema	-	45
Image 1-4	-	45

Image adjust []

Sub-menu item	Factory default	Page
Contrast	32	46
Brightness	32	46
Color*1	32	46
Tint*1	32	46
Color temp.	Mid	46
Red	32	47
Green	32	47
Blue	32	47
Sharpness	8	47
Gamma	Default	47
Noise reduction*1	L1	47
Progressive*1	L1	48
Reset	-	48
Store	-	48

*1 : When input video signal to the projector, these functions will be available.

Screen []

Sub-menu item	Factory default	Page
Normal	-	49
Full	-	49
Wide (16:9)	-	49
Zoom	-	49
True*1	-	49
Natural wide*2	-	49
Custom	-	49
Custom adj.	-	50
Digital zoom + *1	-	50
Digital zoom - *1	-	50
Keystone	Store	50
Ceiling	Off	51
Rear	Off	51
Screen aspect*2	Default(16:10)	51
Colorboard	Off	51
Reset	-	51

*1 : When input computer signal to the projector, these functions will be available.

*2 : PT-CW230EA Only.

Sound []

Sub-menu item	Default	Page
Volume	32	52
Mute	Off	52

Setting []

Sub-menu item	Default	Page
Language	English	53
Menu position	Center	53
Auto setup	-	53
3D setting	-	54
Zoom	Store 1	54
Background	Blue	54
Display	On	54
Logo	-	55
HDMI setup	-	55
Terminal	Computer 2	55
Power management	Shut down	56
Direct on	Off	56
Standby mode	Eco	56
Closed caption	Off	56
Lamp power	Normal	57
Remote control	Code 1	57
Security	-	57
Fan	L2	58
Fan control	Off	58
Lamp runtime	-	58
Filter counter	-	58
Factory default	-	59

Information []

Sub-menu item	Factory default	Page
Input	-	60
H-sync freq.	-	60
V-sync freq.	-	60
Screen	-	60
Language	-	60
Lamp power	-	60
Lamp runtime	-	60
Power management	-	60
Key lock	-	60
PIN code lock	-	60
Remote control	-	60
Serial number	-	60

Network []

Refer to "Operating Instructions, Network operations".

Input menu

Select [Input] from the Main Menu (see “Navigating through the menu” on page 37), then select the item from the sub-menu.

Remote Control

Control Panel

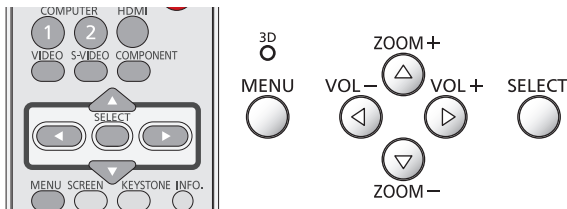

Computer 1: RGB/Component /RGB (Scart)

- 1) Press ▲ ▼ to select [Computer 1].
- 2) Press ► to access the submenu.
- 3) Press ▲ ▼ to select [RGB], [Component] or [RGB(Scart)].

Computer 2: RGB

Press ▲ ▼ to select [Computer 2 (RGB)] and then press the <SELECT> button.

Computer System Selection

This projector automatically tunes to various types of computers with its Multi-scan system and Auto PC Adjustment. If a computer is selected as a signal source, this projector automatically detects the signal format and tunes to project a proper image without any additional settings. (Signal formats provided in this projector are shown on pages 73-76.)

Auto When the projector can not recognize the connected signal conforming to the provided PC Systems, **Auto** is displayed on the System Menu box and the Auto PC adjustment function works to display proper images. If the image is not projected properly, a manual adjustment is required.

---- There is no signal input from the computer. Check the connection between your computer and the projector.

Mode 1 The preset system is manually adjusted in the PC adjust Menu. The adjusted data can be stored in Mode 1-10.

SVGA 1 PC Systems provided in this projector is chosen. The projector chooses a proper system provided in the projector and displays it.

* Mode 1 and SVGA 1 are examples.

- 1) Press ▲ ▼ to select [System].
- 2) Press ► or the <SELECT> button to access the submenu.
- 3) Press ▲ ▼ to select the desired system.

HDMI

Press ▲ ▼ to select [HDMI] and then press the <SELECT> button.

Video

Press ▲ ▼ to select [Video] and then press the <SELECT> button.

S-video

Press ▲ ▼ to select [S-video] and then press the <SELECT> button.

■ Video System Selection

The projector automatically detects an incoming video system, and adjusts itself to optimize its performance.

Note

- When the [Input Search] function is set to [On 1] or [On 2] in the [Auto setup] function, the input signal will be searched automatically.
- The [System] menu cannot be selected when the input is selected to [HDMI], [Video], [S-video] or [RGB(Scart)].

AUTO PC adjust

Select [PC adjust] from the Main Menu (see “Navigating through the menu” on page 37), then select the item from the sub-menu.

Remote Control

Control Panel

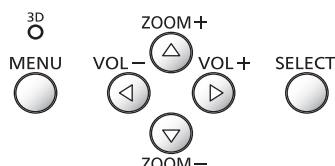
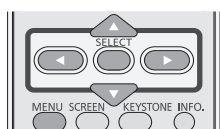

AUTO PC adj.

[Auto PC adjustment] function is provided to automatically adjust [Fine sync], [Total dots], [Horizontal] and [Vertical] positions to conform to your computer.

Press ▲ ▼ to select [AUTO PC adj.] and then press the <SELECT> button.

- [Please wait...] appears while the [Auto PC adjustment] is in process.

To store adjustment parameters

The adjusted parameters from the [Auto PC adjustment] can be stored in the projector. Once the parameters are stored, the setting can be done just by selecting a Mode (1–10) in the PC System Menu (see page 40). See also [Store] on page 44.

Attention

- [Fine sync], [Total dots], [Horizontal] and [Vertical] position of some computers cannot be fully adjusted with the [Auto PC adjustment] function. When the image is not provided properly with this operation, manual adjustments are required (► pages 43-44).
- The [Auto PC adjustment] cannot be operated when [480i], [576i], [480p], [576p], [720p] or [1 080i] is selected in the PC System Menu (► page 40), or when the signal is coming from the HDMI IN terminal.

Manual PC adjust

Select [PC adjust] from the Main Menu (see “Navigating through the menu” on page 37), then select the item from the sub-menu.

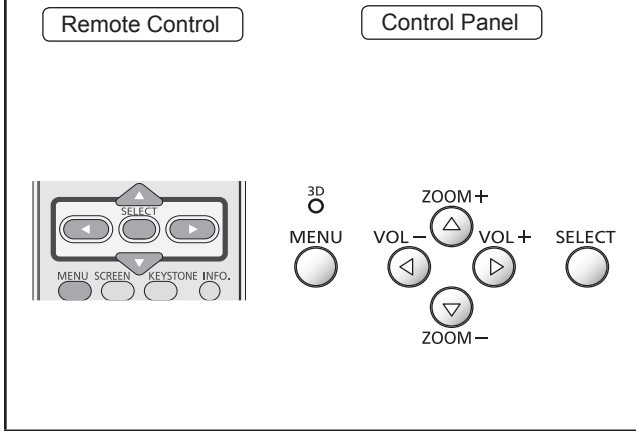

Some computers employ special signal formats which may not be tuned by Multi-scan system of this projector. Manual PC adjustment enables you to precisely adjust several parameters to match those signal formats. The projector has 10 independent memory areas to store those parameters manually adjusted. It allows you to recall the setting for a specific computer.

Fine sync

- 1) Press ▲▼ to select [Fine sync].
- 2) Press the <SELECT> button to display the adjustment dialog box.
- 3) Press ◀▶ to adjust the value.
 - The value can be adjusted from 0 to 31.

Total dots

- 1) Press ▲▼ to select [Total dots].
- 2) Press the <SELECT> button to display the adjustment dialog box.
- 3) Press ◀▶ to adjust the value.

Horizontal

- 1) Press ▲▼ to select [Horizontal].
- 2) Press the <SELECT> button to display the adjustment dialog box.
- 3) Press ◀▶ to adjust the horizontal picture position.

■ For horizontal (right and left) adjustment

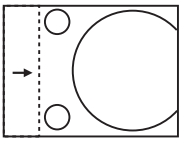
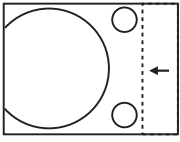
Operation	Adjustment
Press ◀.	The picture position moves to the right. 
Press ▶.	The picture position moves to the left. 

Vertical

- 1) Press ▲▼ to select [Vertical].
- 2) Press the <SELECT> button to display the adjustment dialog box.
- 3) Press ◀▶ to adjust the vertical picture position.

■ For vertical (up and down) adjustment

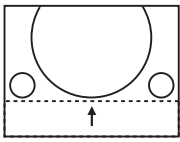
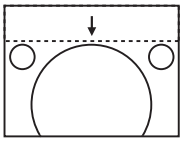
Operation	Adjustment
Press ▶.	The picture position moves up. 
Press ◀.	The picture position moves down. 

Manual PC adjust

Current mode

- 1) Press ▲ ▼ to select [Current mode].
- 2) Press ► or the <SELECT> button to enter the next submenu to show H-sync freq. and V-sync freq. of the connected computer.

Clamp

- 1) Press ▲ ▼ to select [Clamp].
- 2) Press the <SELECT> button to display the adjustment dialog box.
- 3) Press ◀ ▶ to adjust the clamp level.
 - When the image has dark bars, try this adjustment.

Reset

To reset the adjusted data, all adjustments will return to their previous figures.

- 1) Press ▲ ▼ to select [Reset].
- 2) Press the <SELECT> button.
 - A confirmation box appears and then select [Yes].

Mode free

- 1) Press ▲ ▼ to select [Mode free].
- 2) Press ► or the <SELECT> button to enter the next submenu.
 - Move the highlight to the mode that you want to clear and then press the <SELECT> button.
 - A confirmation box appears and then select [Yes].

Store

- 1) Press ▲ ▼ to select [Store].
- 2) Press ► or the <SELECT> button to enter the next submenu.
 - Move the highlight to one of the Modes 1 to 10 in which you want to store, and then press the <SELECT> button.
 - A confirmation box appears and then select [Yes].

Image select

Select [Image select] from the Main Menu (see “Navigating through the menu” on page 37), then select the item from the sub-menu.

Remote Control

Control Panel

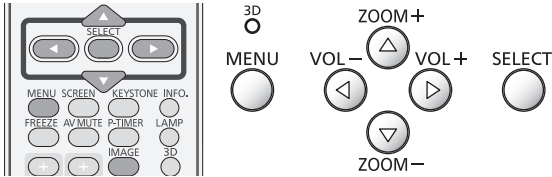

Image 1-4

For viewing with the user preset image mode in the Image adjust Menu.

Press ▲ ▼ to select [Image 1-4] and then press the <SELECT> button.

Dynamic

For viewing pictures in a bright room.

Press ▲ ▼ to select [Dynamic] and then press the <SELECT> button.

Standard

Normal picture mode preset on the projector.

Press ▲ ▼ to select [Standard] and then press the <SELECT> button.

Real

Picture mode with improved halftone for graphics.

Press ▲ ▼ to select [Real] and then press the <SELECT> button.

Cinema

Picture mode adjusted with fine tone.

Press ▲ ▼ to select [Cinema] and then press the <SELECT> button.

Image adjust

Select [Image adjust] from the Main Menu (see “Navigating through the menu” on page 37), then select the item from the sub-menu.

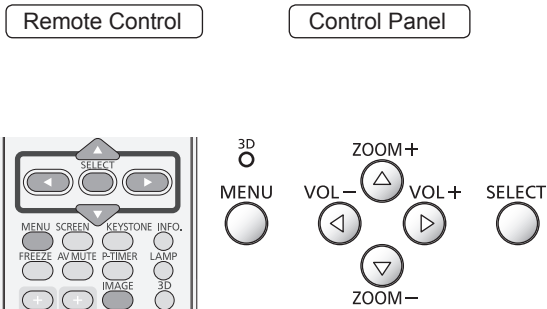

Note

- Make sure you selected [Store] after adjusting settings. Some settings can not be stored if not registered with [Store] function.

Contrast

- 1) Press ▲ ▼ to select [Contrast].
- 2) Press the <SELECT> button to display the adjustment dialog box.
- 3) Press ◀ ▶ to adjust the setting value.

Operation	Adjustment	Adjustment range
Press ▶.	increase the contrast	Maximum value 63
Press ◀.	decrease the contrast	Minimum value 0

Brightness

- 1) Press ▲ ▼ to select [Brightness].
- 2) Press the <SELECT> button to display the adjustment dialog box.
- 3) Press ◀ ▶ to adjust the setting value.

Operation	Adjustment	Adjustment range
Press ▶.	increase the brightness	Maximum value 63
Press ◀.	decrease the brightness	Minimum value 0

Color

- 1) Press ▲ ▼ to select [Color].
- 2) Press the <SELECT> button to display the adjustment dialog box.
- 3) Press ◀ ▶ to adjust the setting value.

Operation	Adjustment	Adjustment range
Press ▶.	increase the intensity of the color	Maximum value 63
Press ◀.	decrease the intensity of the color	Minimum value 0

Note

- When input video signal to the projector, [Color] will be available.

Tint

- 1) Press ▲ ▼ to select [Tint].
- 2) Press the <SELECT> button to display the adjustment dialog box.
- 3) Press ◀ ▶ to adjust the tint value to get a proper color balance.
 - Adjustments can be made between 0 and 63.

Note

- When you select [NTSC] or [NTSC4.43] in System menu under Video input signal, [Tint] will be available.

Color temp.

- 1) Press ▲ ▼ to select [Color temp.].
- 2) Press the <SELECT> button to display the adjustment dialog box.
- 3) Press ◀ ▶ to select the desired Color temp. level.
 - You can select the desired [Color temp.] from [XLow], [Low], [Mid] or [High].

Red

- 1) Press ▲▼ to select [Red].
- 2) Press the <SELECT> button to display the adjustment dialog box.
- 3) Press ◀▶ to adjust the setting value.

Operation	Adjustment	Adjustment range
Press ▶.	deepen red tone	Maximum value 63
Press ◀.	lighten red tone	Minimum value 0

Green

- 1) Press ▲▼ to select [Green].
- 2) Press the <SELECT> button to display the adjustment dialog box.
- 3) Press ◀▶ to adjust the setting value.

Operation	Adjustment	Adjustment range
Press ▶.	deepen green tone	Maximum value 63
Press ◀.	lighten green tone	Minimum value 0

Blue

- 1) Press ▲▼ to select [Blue].
- 2) Press the <SELECT> button to display the adjustment dialog box.
- 3) Press ◀▶ to adjust the setting value.

Operation	Adjustment	Adjustment range
Press ▶.	deepen blue tone	Maximum value 63
Press ◀.	lighten blue tone	Minimum value 0

Sharpness

- 1) Press ▲▼ to select [Sharpness].
- 2) Press the <SELECT> button to display the adjustment dialog box.
- 3) Press ◀▶ to adjust the setting value.

Operation	Adjustment	Adjustment range
Press ▶.	increase the sharpness of the image	Maximum value 15
Press ◀.	decrease the sharpness of the image	Minimum value 0

Gamma

- 1) Press ▲▼ to select [Gamma].
- 2) Press the <SELECT> button to display the adjustment dialog box.
- 3) Press ◀▶ to adjust the gamma value to obtain a better balance of contrast.
 - Adjustments can be made among [Default/1.8/2.0/2.2/2.4/2.6].

Noise reduction

- 1) Press ▲▼ to select [Noise reduction].
- 2) Press the <SELECT> button to display the adjustment dialog box.
- 3) Press ◀▶ to select the desired item

Off	Disabled
L 1	Lower reduction
L 2	Higher reduction

- Noise interference on the screen can be reduced. Select one of the above options to get smoother images.

Note

- When input video signal to the projector, [Noise reduction] will become available.
- [Noise reduction] cannot be selected when [480p], [576p], [720p] or [1 080p] is selected.
- [Noise reduction] cannot be selected when [On] or [NVIDIA 3D VISION] is selected in [3D] of [3D setting].

Image adjust

Progressive

- 1) Press ▲ ▼ to select [Progressive].
- 2) Press the <SELECT> button to display the dialog box.
- 3) Press ◀ ▶ to select the desired item.
 - An interlaced video signal can be displayed in progressive mode. Select one of the following options.

Off	Disabled
L 1	For an active picture
L 2	For a still picture
Film	For watching a film

Note

- When input video signal to the projector, [Progressive] will become available.
- [Progressive] cannot be selected when [480p], [576p], [720p] or [1 080p] is selected.
- [Film] cannot be selected when [1 080i] is selected.
- [Progressive] cannot be selected when [On] or [NVIDIA 3D VISION] is selected in [3D] of [3D setting].

Reset

To reset the adjusted data, all adjustments will return to their previous figures.

- 1) Press ▲ ▼ to select [Reset].
- 2) Press the <SELECT> button.
 - A confirmation box appears and then select [Yes].

Store

- 1) Press ▲ ▼ to select [Store].
- 2) Press ▶ or the <SELECT> button.
- 3) Press ▲ ▼ to select one from Image 1 to 4 and press the <SELECT> button.
 - A confirmation box appears and then select [Yes].

Screen

Select [Screen] from the Main Menu (see “Navigating through the menu” on page 37), then select the item from the sub-menu.

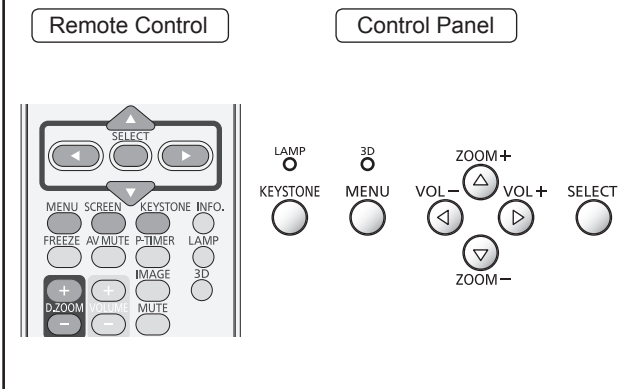

Normal

Provide the image to fit the screen size while maintaining the aspect ratio of the input signal.

Press **▲▼** to select [Normal] and then press the **<SELECT>** button.

Full

Provide the full screen image.

Press **▲▼** to select [Full] and then press the **<SELECT>** button.

Wide(16:9)

Provide the image at the 16:9 wide screen ratio.

Press **▲▼** to select [Wide(16:9)] and then press the **<SELECT>** button.

Zoom

Scale the image proportionally to fit the entire screen. Either side of image may go over the screen.

Press **▲▼** to select [Zoom] and then press the **<SELECT>** button.

True

Provide the image in its original size. When the original image size is larger or smaller than the panel size (1 280 x 800),* the projector enters to the panning mode automatically.

1) Press **▲▼** to select [True] and then press the **<SELECT>** button.

2) Press **▲▼◀▶** to pan the image.

- When adjusted, the arrows will turn red. When reached to the correction limits, the arrows will disappear.

* Screen size (1 280 x 800) is only for PT-CW230EA. Screen size (1 024 x 768) is for PT-CX200EA.

Note

- When input computer signal to the projector, [True] will be available.
- [True] is disabled and cannot be displayed when [480i], [576i], [480p], [576p], [720p] or [1 080i] is selected in the PC System Menu.
- When [True] is selected in the Screen menu, [Digital zoom +/-] can not be selected.

Natural wide (PT-CW230EA Only)

Modify the 4:3 aspect ratio image to fit the screen size by stretching the image to make it look natural.

Press **▲▼** to select [Natural wide] and then press the **<SELECT>** button.

Note

- When input video signal to the projector, [Natural wide] will be available.
- [Natural wide] is not available when [720p] or [1 080i] is selected in the PC System Menu.

Custom

Provide the last stored aspect screen image.

Press **▲▼** to select [Custom] and press the **<SELECT>** button.

Screen

Custom adj.

Adjust the screen scale and position manually with this function.

- 1) Press ▲ ▼ to select [Custom adj.].
- 2) Press ► or the <SELECT> button to enter the next submenu.
- 3) Press ▲ ▼ to choose the item you want to adjust.
 - You can choose one from the items as below:

Scale H/V	Adjust the Horizontal/Vertical screen scale.
H&V	When set to [On], the aspect ratio is fixed.
Position H/V	Adjust the Horizontal/Vertical screen position.
Common	Save the adjusted scale or position to all the inputs.
Reset	Reset the all adjusted values.

Digital zoom +

Zoom in the images.

- 1) Press ▲ ▼ to select [Digital zoom +] and then press the <SELECT> button.
 - The On-Screen Menu disappears and [D. zoom +] appears.
- 2) Press the <SELECT> button to zoom in the image size and press ▲ ▼ ◀▶ to move the image to the top/bottom/left/right of the screen.
 - The Panning function can work only when the image is larger than the screen size. A projected image can be also expanded by pressing the <D.ZOOM +> or the <SELECT> button.

Digital zoom -

Zoom out the images.

- 1) Press ▲ ▼ to select [Digital zoom -] and then press the <SELECT> button.
 - The On-Screen Menu disappears and [D.zoom -] appears.
- 2) Press the <SELECT> button to zoom out image size.
 - The projected image can be also compressed by pressing the <D.ZOOM -> or the <SELECT> button.

To exit the Digital zoom +/- mode, press any button except the <D.ZOOM +/->, <SELECT> and ▲ ▼ ◀▶ buttons.

To return to the previous screen size, select a screen size from the Screen Size Adjustment Menu or select an input source from the Input Source Selection Menu (►pages 40-41) again, or adjust the screen size with the <D.ZOOM +/-> buttons.

Note

- When input computer signal to the projector, this function will be available.
- [Digital zoom +/-] cannot be selected when [True] is selected in the Screen aspect.
- [Digital zoom +/-] are disabled and cannot be displayed when [480i], [576i], [480p], [576p], [720p], [1 080i] or [1 080p] is selected in the PC System Menu (►page 40).
- When [Digital zoom +/-] functions are disabled, ! mark will appear.

Keystone

This function is used to adjust keystone distortion of the projected image.

- 1) Press ▲ ▼ to select [Keystone].
- 2) Press ► or the <SELECT> button.
- 3) Press ▲ ▼ to choose the item you want to adjust.

Keystone	To correct keystone distortion
Store	To store or reset the keystone correction



The following items are the submenu of [Store].

Store	Keep the keystone correction even when the AC power cord is plugged out or turned off the projector.
Reset	Release the keystone correction when the AC power cord is plugged out.

Ceiling

This function is used to project the image from a ceiling-mounted projector.

- 1) Press ▲▼ to select [Ceiling] and then press the <SELECT> button.
- 2) Press ▲▼ to change the image.
 - When this function is set to [On], the picture will be top/bottom and left/right reversed.

Rear

This function is used to project the image from rear of the screen.

- 1) Press ▲▼ to select [Rear] and then press the <SELECT> button.
- 2) Press ▲▼ to change the image.
 - When this function is set to [On], the picture will be left/right reversed.

Screen aspect (PT-CW230EA Only)

This function is used to project the image to a 4:3 or 16:9 projection screen.

- 1) Press ▲▼ to select [Screen aspect] and then press the <SELECT> button.
- 2) Press ▲▼ to choose one from the items as below.

Default(16:10)	16:10 is the aspect of the DLP chips.
16:9	Set to a 16:9 projection screen.
4:3	Set to a 4:3 projection screen.

Attention

- When the [4:3] function is selected, [Natural wide] is not available in the AV screen.
- When the [16:9] function is selected, [Wide (16:9)] is not available in the AV screen.

Colorboard

For the image projected on a colorboard.

- 1) Press ▲▼ to select [Colorboard].
- 2) Press ► or the <SELECT> button to display the submenu.
 - Adjustments can be made among [Off/Red/Blue/Yellow/Green/Blackboard(Green)].

Reset

To reset the adjusted data, all adjustments will return to their previous figures.

- Press ▲▼ to select [Reset] and then press the <SELECT> button.
- A confirmation box appears and then select [Yes].

Sound

Select [Sound] from the Main Menu (see “Navigating through the menu” on page 37), then select the item from the sub-menu.

Remote Control

Control Panel

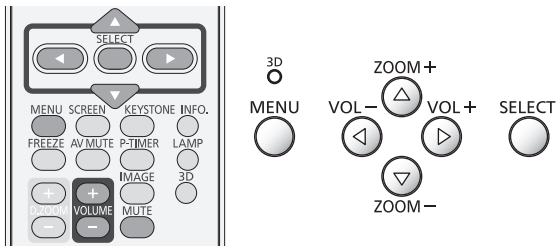

Volume

- 1) Press ▲▼ to select [Volume] and then press the <SELECT> button.
- 2) Press ◀▶ to adjust the volume.
 - Press <SELECT> button to set the volume.

Operation	Adjustment	Adjustment range
Press ▶.	turn up the volume	Maximum value 63
Press ◀.	turn down the volume	Minimum value 0

- You can also press <VOLUME+/-> buttons on the remote control or control panel to adjust the volume.

Mute

- 1) Press ▲▼ to select [Mute] and then press the <SELECT> button.
- 2) Press the <SELECT> button to switch the mute function [On]/[Off].
 - Press the <MUTE> button on the remote control to temporarily turn off the sound. To turn the sound back on, press the <MUTE> button again or press the <VOLUME+/-> buttons.

Setting

Select [Setting] from the Main Menu (see “Navigating through the menu” on page 37), then select the item from the sub-menu.

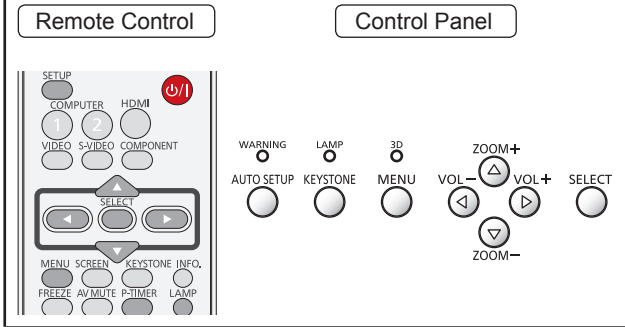

Menu position

This function is used to change the position of the On-Screen Menu.

- 1) Press ▲ ▼ to select [Menu position].
- 2) Press the <SELECT> button to change the position.
 - The Menu position changes each time you press <SELECT> button as follows:

the center → the bottom left → the bottom right → the top left → the top right → the center.....

Language

- 1) Press ▲ ▼ to select [Language].
- 2) Press ► or the <SELECT> button.
- 3) Press ▲ ▼ to select the desired language.

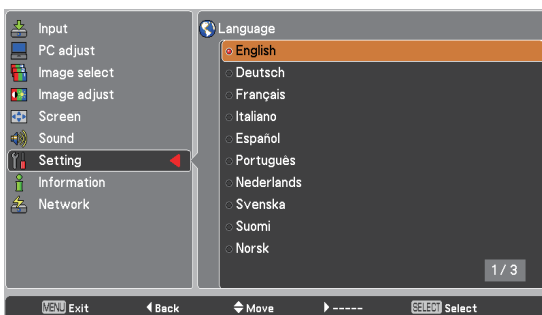
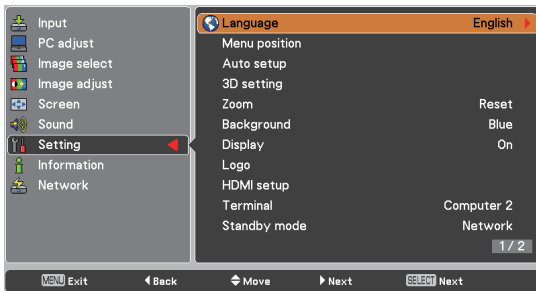

- The language used in the On-Screen Menu is available in English, German, French, Italian, Spanish, Portuguese, Dutch, Swedish, Finnish, Norwegian, Danish, Polish, Hungarian, Romanian, Russian, Turkish, Arabic, Kazak, Simplified Chinese, Traditional Chinese, Korean, Japanese and Thai.

Auto setup

- 1) Press ▲ ▼ to select [Auto setup].
- 2) Press ► or the <SELECT> button.
- 3) Press ▲ ▼ to select these functions as follows:

Input search

This function detects the input signal automatically. When a signal is found, the search will stop.

Off	Input search will not work
On 1	Input search works* ¹
On 2	Input search works* ²

*1 : •When pressing the <AUTO SETUP> button on the remote control or the control panel.

*2 : •When turning on the projector by pressing the <|/⏻> button on the remote control or the control panel.

•When pressing the <AUTO SETUP> button on the remote control or the control panel.

•When the current input signal is cut off.*

* If the [AV mute] or [Freeze] function is active, cancel it to activate the Input search. It is also unavailable when On-Screen menu is displayed.

Auto PC adj.

On	Enables Auto PC adjustment * ¹
Off	Disables Auto PC adjustment

*1 : When pressing the <AUTO SETUP> button on the remote control or the control panel.

Note

- [Input search] and [Auto PC adj.] cannot be set [Off] at the same time.

Setting

3D setting

This function is used to set the 3D display function.

Press ▲ ▼ to select these functions as follows:

3D

Select among [Off], [On] and [NVIDIA 3D VISION] mode.

** When selecting [NVIDIA 3D VISION] mode, the other menus [3D sync], [3D->2D], [3D phase] setting are not necessary. (displayed in gray)*

3D sync

If you see a discrete or overlapping image, 3D Sync Invert function* enables you to get the correct image. Switch the 3D sync signal to **1** or **2**.

3D->2D

When viewing the 3D contents without wearing the 3D glasses, set to "On" to convert 3D display format to 2D display format.

3D phase

Adjust the phase of the 3D sync signal when the 3D SYNC OUT terminal is used. (0 - 31)

Note

- The Frame Sequential Format is a technology that rapidly alternates between left-eye and right-eye images. When right-eye image and left-eye image are switched or you feel like you cannot get 3D effect due to out-of- synchronization state, first try to synchronize the projector with the 3D glasses by using 3D SYNC function.

Zoom

This function is used to memorize the Zoom adjustment with the <ZOOM +/-> buttons on the control panel.

Press ▲ ▼ to switch between each option as below.

Reset	Reset the Zoom adjustment when the projector is turned off or the AC power cord is unplugged.
Store1	Store the Zoom setting even when the projector is turned off. Zoom setting is cleared when the AC power cord is unplugged.
Store2	Store the Zoom setting even when the AC power cord is unplugged.

Background

Select the background screen for when no input signal is detected.

- 1) Press ▲ ▼ to select [Background].
- 2) Press the <SELECT> button.
- 3) Press ▲ ▼ to switch between each option as below.

Blue	Blue colored background.
Black	Black colored background.

Display

This function decides whether to display On-Screen Displays.

- 1) Press ▲ ▼ to select [Display].
- 2) Press the <SELECT> button.
- 3) Press ▲ ▼ to switch between each option as below.

On	Show all the On-Screen displays *1
Countdown off	Show the input image instead of the countdown when turning on the projector *2
Off	Hide the On-Screen Displays *3

- *1 : Use this function when you want to project images after the lamp becomes bright enough. The factory default setting is in this option.
- *2 : Use this function when you want to project the image as early as possible even when the lamp is not bright enough.
- *3 : Hide the On-Screen Displays except;
- On-Screen Menu.
 - [Power off?]
 - [P-timer] display.
 - No signal for [Power management]
 - [Please wait ...]
 - Arrows for the True function in the Screen Menu.

Logo

This function allows you to customize the screen logo with [Logo select], [Logo PIN code lock] and [Logo PIN code change] functions.

- 1) Press **▲▼** to select [Logo].
- 2) Press **▶** or the **<SELECT>** button.
- 3) Press **▲▼** to choose the desired item.

■ Logo select

This function decides on the starting-up display from among following options.

Off	Show the countdown display only.
Default	Show the factory-set logo.

■ Logo PIN code lock

This function prevents an unauthorized person from changing the screen logo.

Off	The screen logo can be changed freely from the Logo Menu.
On	The screen logo cannot be changed without a Logo PIN code.

Note

- If you want to change the Logo PIN code lock setting, press the **<SELECT>** button and the Logo PIN code dialog box appears. Enter a Logo PIN code by following the steps below. The initial Logo PIN code is set to "4321" at the factory.

■ Logo PIN code change

Logo PIN code can be changed to your desired four-digit number.

- 1) Press **▲▼** to select [Logo PIN code change] and press the **<SELECT>** button.
 - Current logo PIN code dialog box appears.
- 2) Press **▲▼** to enter the current code, press the **▶** button to fix the number and move the red frame pointer to the next box.
 - The New Logo PIN code input dialog box appears.
- 3) Repeat this step to set the new Logo PIN code.

Attention

- Be sure to note the new Logo PIN code and keep it on hand. If you lost the number, you could no longer change the Logo PIN code setting.

HDMI setup

This function is only used for HDMI input source.

- 1) Press **▲▼** to select [HDMI setup].
- 2) Press **▶** or the **<SELECT>** button.
 - The names for the output setting of Digital R/G/B vary from equipment to equipment.

■ Image

Normal	When the output of Digital R/G/B equipment is set to Standard.
Enhanced	When the output of Digital R/G/B equipment is set to Enhanced.

■ Sound

HDMI	When Digital input source is input, Sound is set to HDMI.
Computer 1	When DVI input source is changed to HDMI input source, Sound is set to Computer 1.

Note

- For details, refer to the operating instructions of your Digital R/G/B equipment.

Terminal

The COMPUTER 2 IN/MONITOR OUT terminal on the back of the projector is switchable for computer 2 input or monitor output.

- 1) Press **▲▼** to select [Terminal] and then press the **<SELECT>** button.
- 2) Press **▲▼** to switch the item.

Computer 2	Computer input
Monitor out	Monitor out

Note

- Terminal function is not available when selecting [Computer 2] to the input source. Change the input source to the others (Computer 1, HDMI,S-video or Video) so that the Terminal function will be available.

Setting

Standby mode

This function can set the electric power when the projector is standing by.

- 1) Press ▲ ▼ to select [Standby mode] and then press the <SELECT> button.
- 2) Press ▲ ▼ to switch between the items as below.

Eco	Restricts some functions in standby mode to reduce power consumption.
Network	Does not restrict functionality even in standby mode.

Note

- When selecting [Network], the cooling fans may be running depending on the temperature inside the projector even if the projector is turned off.
- Refer to "Operating Instructions - Network Operations".
- If Standby mode is set to [Eco], you cannot use network functions when the projector is standing by. Also, you cannot use some RS-232C protocol commands.
- If set to [Network], you can use network functions when the projector is standing by.

Power management

For reducing power consumption as well as maintaining the lamp life, the Power management function turns off the projection lamp when the projector is not operated for a certain period.

- 1) Press ▲ ▼ to select [Power management].
- 2) Press ► or the <SELECT> button to access the submenu.

Mode

- 1) Press ▲ ▼ and then press the <SELECT> button to select one mode among the items as below.

Ready	When the lamp has been fully cooled down, the <ON(G)/STANDBY(R)> indicator changes to green blinking. In this condition, the projection lamp will be turned on if the input signal is reconnected or any button on the control panel or remote control is pressed
Shut down	When the lamp has been fully cooled down, the power will be turned off.
Off	[Power management] function is off.

Timer

- 1) Press ▲ ▼ to select [Timer] and then press the <SELECT> button.
- 2) Press ▲ ▼ to set the Timer(1~30min).

Direct on

- 1) Press ▲ ▼ to select [Direct on] and then press the <SELECT> button.
- 2) Press ▲ ▼ to switch between [On] and [Off].

- When this function is set to [On], the projector will be automatically turned on just by connecting the AC power cord to a wall outlet.
- Be sure to turn off the projector properly. If the projector is turned off in the incorrect sequence, the [Direct On] function does not work properly.

Closed caption

[Only for NTSC input]

- 1) Press ▲ ▼ to select [Closed caption].
- 2) Press ► or the <SELECT> button to enter the submenu.

Closed caption

- 1) Press ▲ ▼ to select [Closed caption] and then press the <SELECT> button.
- 2) Press ▲ ▼ to select [Off], [CC1], [CC2], [CC3] or [CC4].

Color

- 1) Press ▲ ▼ to select [Color] and then press the <SELECT> button.
- 2) Press ▲ ▼ to select [Color] or [White].



Note

- The closed caption is mainly used in the north America. This function shows the text information contained in the image signal. Captions may not be displayed on some devices or software.
- You can select [Closed caption] when [NTSC] signal is input.
- Part of characters may not displayed when high compensation values are set in [Keystone].
- Closed captions are not displayed while the menu screen appears.

Lamp power

This function allows you to change brightness of the screen.

- 1) Press ▲▼ to select [Lamp power] and then press the <SELECT> button .
- 2) Press ▲▼ to select one among the modes as below.
 - You can also press the <LAMP> button to display [Lamp power].

 Normal	Normal brightness.
 Eco	Lower brightness reduces the lamp power consumption and extends the lamp life.

Remote control

This switching function prevents remote control interference when operating several projectors or video equipment at the same time.

- 1) Press ▲▼ to select [Remote control].
- 2) Press ► or the <SELECT> button.
- 3) Press ▲▼ to select one among the two codes.
 - This projector provides 2 different remote control codes: [Code 1] and [Code 2].

Note

- When different codes are set on the projector and on the remote control, any operation cannot be made. In that case, switch the code on the remote control to fit the code on the projector.
- If the batteries are removed from the remote control for a long period of time, the remote control code will be reset.

Security



This function allows you to use the Key lock and PIN code lock function to set the security for the projector operation.

- 1) Press ▲▼ to select [Security].
- 2) Press ► or the <SELECT> button to access the submenu.

■ Key lock

This function locks the control panel and remote control buttons to prevent operation by unauthorized persons.

- 1) Press ▲▼ to select the desired items as below.

	Unlocked.
	Lock the operation of the control panel. To unlock, use the remote control.
	Lock the operation of the remote control. To unlock, use the control panel.

■ PIN code lock

This function prevents the projector from being operated by unauthorized persons and provides the following setting options for security.

- 1) Press ▲▼ to select the desired items as below.

Off	Unlocked.
On 1	Enter the PIN code every time turning on the projector.
On 2	Enter the PIN code to operate the projector once the power cord is disconnected; as long as the AC power cord is connected, the projector can be operated without a PIN code.

Note

- Whenever you change the PIN code lock setting or the PIN code (the four-digit number), you are required to enter the PIN code. The "1234" is set as the initial PIN code at the factory.

Setting

■ PIN code change

The PIN code can be changed to your desired four-digit number.

- 1) Press ▲ ▼ to select [PIN code change] and then Press <SELECT> button.
 - Current Pin code dialog box appears.
- 2) Press ▲ ▼ to enter the current code. Press ► button to fix the number and move the red frame pointer to the next box.
 - The New PIN code input dialog box appears.
- 3) Repeat these steps to set a new PIN code.

Attention

- Be sure to note the new PIN code and keep it on hand. If you lost the number, you could no longer change the PIN code setting.

Fan

- 1) Press ▲ ▼ to select [Fan] and then press <SELECT> button.
- 2) Press ▲ ▼ to select one option.
 - This function provides the following options in the cooling fans' operation when the projector is turned off.

L 1	It takes less time to cool the projector down than L 2 mode.
L 2	Slower and lower-sound than L 1 mode, but it takes more time to cool the projector down.

Fan control

- 1) Press ▲ ▼ to select [Fan control] and then Press <SELECT> button.
- 2) Press ▲ ▼ to select one among options as below.
 - Choose the running speed of cooling fans from the following options according to the ground elevation under which you use the projector.

Off	Normal speed.*1
On 1	Faster than [Off] mode.*2
On 2	Faster than [On 1] mode.*3

- *1 : Set this function to [Off] when using the projector in non-high altitude environment.
- *2 : Select this mode when using the projector in high altitudes (about 1 000 meters or more above the sea level) where the fans have less cooling effect.
- *3 : Select this mode when using the projector in higher altitudes (than above where the fans have lesser cooling effect).

It is recommended to select [On 1] when the altitudes is over about 1 000 m and select [On 2] when the altitudes is over about 2 000 m.

Note

- Failure to set the running speed of cooling fans properly may affect the projector life.
- The fan noise becomes louder in [On 1] and [On 2].

Lamp runtime

This function is used to display the cumulative lamp operating time and reset the lamp runtime.

- 1) Press ▲ ▼ to select [Lamp runtime].
- 2) Press ► or the <SELECT> button to access the submenu items.

■ Lamp runtime

Show the total accumulated lamp run time.

■ Lamp runtime reset

After replacing the lamp unit, be sure to reset the timer.

- 1) Press ▲ ▼ to select [Lamp runtime reset].
- 2) Press the <SELECT> button.
 - [Lamp runtime Reset?] appears. Select [Yes] to continue. Another confirmation dialog box appears, select [Yes] to reset the Lamp runtime.

Attention

- When the lamp run time is elapsed the estimated duration, [Lamp runtime] will be displayed in red and the Lamp replacement icon (➡page 64) will appear on the screen, indicating that the end of lamp life is reached. When replacing the lamp unit, reset the lamp runtime.

Filter counter

This function is used to set a frequency for the filter replacement.

- 1) Press ▲▼ to select [Filter counter].
- 2) Press ► or the <SELECT> button to access the submenu items.

■ Filter counter

Show the total accumulated time of the filter use timer setting.

■ Timer

To set a timer. When the projector reaches the selected time the filter warning icon appears on the screen.

- 1) Press ▲▼ to select [Timer] and then press the <SELECT> button.
- 2) Press ▲▼ to set the Timer.
 - Select from [Off/2000 H/3000 H/4000 H] depending on the use environment.

■ Filter counter reset

After replacing the filter unit, be sure to reset the timer.

- 1) Press ▲▼ to select [Filter counter reset].
- 2) Press the <SELECT> button.
 - [Filter counter Reset?] appears. Select [Yes] to continue. Another confirmation dialog box appears, select [Yes] to reset the [Filter counter].

Factory default

This function returns all setting values except for the [PIN code lock], [Logo PIN code lock], [Lamp runtime] and [Filter counter] to the factory default settings.

- 1) Press ▲▼ to select [Factory default].
- 2) Press the <SELECT> button.
 - [Return to Factory default?] appears. Select [Yes] to continue. Another confirmation dialog box appears, select [Yes] to return to [Factory default].

Information

Select [Information] from the Main Menu (see “Navigating through the menu” on page 37), then select the item from the sub-menu.

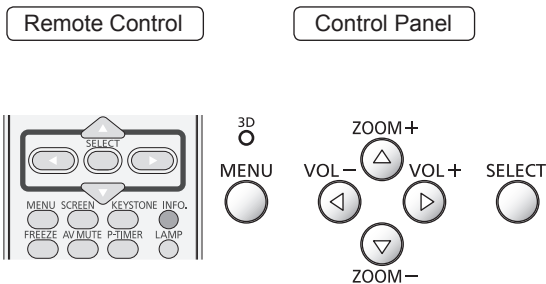

Input Source Information Display

The Information Menu is used for checking the status of the image signal being projected and the operation of the projector.

You can also Press the <INFO.> button on the remote control to display the Information menu.

■ Input

The selected input source is displayed.

■ H-sync freq.

The selected H-sync freq. is displayed.
The horizontal frequency of the input signal is displayed in KHz, or - - - - KHz when no signal.

■ V-sync freq.

The selected V-sync freq. is displayed.
The vertical frequency of the input signal is displayed in Hz, or - - - - Hz when no signal. Numbers of Hz doubles when during Interlace.

■ Screen

The selected Screen size is displayed.

■ Language

The selected language is displayed.

■ Lamp power

The selected lamp mode is displayed.

■ Lamp runtime

The cumulative lamp operating time is displayed.

■ Power management

[Off], [Ready] or [Shut down], and [Timer] are displayed.

■ Key lock

The selected Key lock icon is displayed.

■ PIN code lock

[Off], [On 1] or [On 2] is displayed.

■ Remote control

The selected remote control code is displayed.

■ Serial number

The serial number of the projector is displayed.
The serial number is used to service the projector.

LAMP and WARNING Indicators

Managing the indicated problems

If a problem should occur inside the projector, the <ON(G)/STANDBY(R)> , <LAMP> and/or <WARNING> indicators will inform you. Manage the indicated problems as follow.

CAUTION

- Before you take a remedial measure, follow the procedure of switching the power off indicated in “Turning off the projector”. (➔page 30)
- If multiple indicators light or blink, verify the status of the projector by looking at each indicator.

Note

- Confirm the status of the power indicated on the <ON(G)/STANDBY(R)> indicator.

LAMP indicator

Indicator	Lights in yellow.
Status	The projection lamp reaches its end of life.
Check	Is there a Lamp replacement icon appears on the screen?
Remedy	Replace the lamp unit. (➔page 65)

Note

- Contact your dealer for repair services when <LAMP> indicator persists to light after taking these measurements.

WARNING indicator

Indicator	Lights in red.	Blinks in red.
Status	The projector detects an abnormal condition and cannot be turned on.	The temperature inside the projector is abnormally high. The projector cannot be turned on. And the <ON(G)/STANDBY(R)> indicator also blinks in red.
Check	Unplug the AC power cord and plug it again to turn on the projector.	- Did you provide appropriate space for the projector to be ventilated? Check the installing condition to see if the air vents of the projector are not blocked. - Has the projector been installed near an Air-Conditioning/ Heating Duct or Vent? - Is the filter clean?
Remedy	If the projector is turned off again, unplug the AC power cord and contact the dealer or the service center for service and checkup.	- Provide good installing condition to your projector. - Move the installation of the projector away from the duct or vent. - Replace the filter unit.

Note

- If <WARNING> indicator persists to light or blink after taking these measurements, please contact your dealer for repair services. Do not leave the projector on. It may cause an electric shock or a fire hazard.
- The projector detects an abnormal condition and cannot be turned on. Unplug the AC power cord and plug it again to turn on the projector. If the projector is turned off again, unplug the AC power cord and contact the dealer or the service center for service and checkup. Do not leave the projector on. It may cause an electric shock or a fire hazard.

Replacement

Before replacing the unit

- When you perform maintenance or replacement of the parts, make sure to turn off the power and disconnect the power plug from the wall outlet. (➔ pages 26, 30)
- Be sure to observe the procedure “Turning off the projector” (➔ page 30) when performing power supply operation.

Maintenance

Outer Case

Wipe off dirt and dust using a soft dry cloth.

- If the dirt is persistent, soak the cloth with water and wring it thoroughly before wiping. Dry off the projector with a dry cloth.
- Do not use benzene, thinner, or rubbing alcohol, other solvents, household cleaners, or chemical treated dusters. Using them may cause deterioration of the outer case.

Glass surface of the projection window.

Wipe off the dirt and dust off the surface of the projection window with soft clean cloth.

- Do not use a cloth that has an abrasive surface or a cloth that is moist, oily, or covered with dust.
- Do not use excessive force when wiping the projection window as it is fragile.

Attention

- The projection window is fragile. Impacts or excessive force when wiping may scratch its surface. Please handle with care.

Replacing the unit

Air filter unit

Filter prevents dust from accumulating on the optical elements inside the projector. Should the air filter become clogged with dust particles, it will reduce cooling fans' effectiveness and may result in internal heat buildup and adversely affect the life of the projector.

If a “Filter warning” icon appears on the screen, replace the air filter unit immediately.

Replacement of the air filter unit

1) Open the lamp cover.

- First, turn off the projector and unplug the AC power cord from the AC outlet. Then, clean up the dust on the projector and around the air vents. At last, loosen the screw and open the lamp cover.

2) Remove the air filter unit.

- Lift the air filter unit out of the projector.

3) Insert a new air filter unit.

- Insert a new air filter unit back into the position.

4) Close the lamp cover.

- Close the lamp cover and secure the screw.

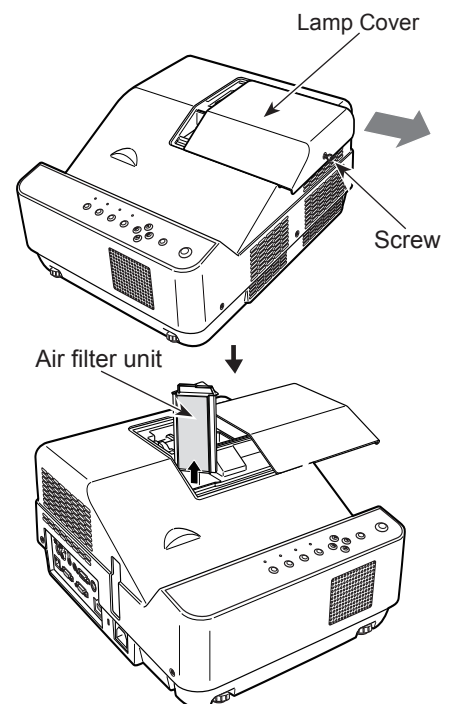

■ Resetting the Filter Counter

Be sure to reset the Filter counter after replacing the air filter unit. (➔page 59" **Filter counter reset**")

Attention

- Turn off the power before you replace the air filter unit.
- When attaching the air filter unit, make sure that the projector is stable, and work in an environment that is safe, even in the event of the air filter unit dropping.
- Do not operate the projector with the filter removed. Dust may accumulate on the optical elements degrading picture quality.
- Do not put anything into the air ports. Doing so may result in malfunction of the projector.
- The air filter unit to be replaced should be an unused product.
- After replacing the air filter, reset the filter counter. Otherwise, the power of the projector may be turned off for safety.

Replacement

Lamp unit

The lamp unit is a consumable component. You can check the total usage time using Lamp runtime in the Information menu on page 60.

It is recommended to ask an authorized engineer to replace the lamp unit. Contact your dealer. Consult your dealer to purchase a replacement lamp unit (ET-LAC100).

CAUTION:

- **Do not replace the lamp unit when it is hot. (Wait at least 1 hour after use.)**

The inside of the cover can become very hot, take care to avoid burn injuries.

Notes on the replacement of the lamp unit

- The luminous source of the lamp is made of glass and may burst if you hit it against a hard surface or drop it.
Please handle with care.
- A Phillips screwdriver is required for replacement of the lamp unit.
- When replacing the lamp unit, be sure to hold it by the handle.
- When replacing the lamp because it has stopped illuminating, there is a possibility that the lamp may be broken. If replacing the lamp of a projector which has been installed on the ceiling, you should always assume that the lamp is broken, and you should stand to the side of the lamp cover, not underneath it. Open the lamp cover gently. Small pieces of glass may fall out when the lamp cover is opened. If pieces of glass get into your eyes or mouth, seek medical advice immediately.
- The lamp contains mercury. Consult your local municipality or your dealer about correct disposal of used lamp units.

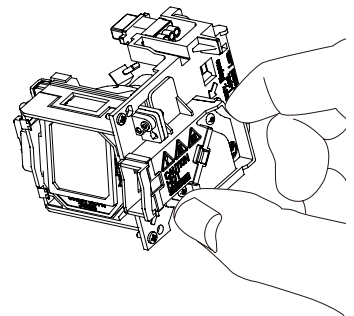



Attention

- Do not use other than designated lamp units.
- The part numbers of accessories and separately sold components are subject to change without notice.

When to replace the lamp unit

The lamp unit is a consumable component. Brightness decreases according to duration of usage, so periodical replacement of the lamp unit is necessary.

When the projection lamp of the projector reaches its end of life, the Lamp replacement icon appears on the screen and <LAMP> indicator lights yellow. Replace the lamp with a new one promptly.

Lamp runtime	On screen Lamp replacement icon	LAMP indicator
Over 2 000 hours		
	The message is displayed for 4 seconds. If you press any button within the 4 seconds, the message disappears.	Lights in yellow (even in stand-by mode).

*2 000 hours of use is a rough guideline, but is not a guarantee. The lamp runtime differs depending on the setting of "Lamp power" menu.

Note

- The Lamp replacement icon will not appear when the [Display] function is set to [Off] (➔page 54), or during "Freeze" (➔page 34), or "AV mute" (➔page 35).

■ Replacing the Lamp unit

CAUTION:

- When the projector is mounted on a ceiling, do not work with your face close to the projector.
- Attach the lamp unit and the lamp cover securely.
- When you experience difficulty in installing the lamp, remove it and try again. If you use force to install the lamp, the connector may be damaged.

1) Turn off the Power by following the procedure in "Turning off the projector" (➔page 30). Unplug the AC power cord. Wait at least 1 hour and make sure the lamp unit and surroundings are cool.

2) Use a Phillips screwdriver to loosen the lamp cover fixing screw and open the lamp cover.

- Open the lamp cover by pulling it slowly toward the direction of the arrow.

3) Use a Phillips screwdriver to loosen the two lamp unit fixing screws until the screws turn freely. Hold the used lamp unit by its handles, and pull it gently from the projector.

4) Insert the new lamp unit in correct direction. Tighten the two lamp unit fixing screws securely with a Phillips screwdriver.

5) Close the lamp cover, and tighten the lamp cover fixing screw securely with a Phillips screwdriver.

- Close the lamp cover by pushing it slowly opposite the direction of the arrow.

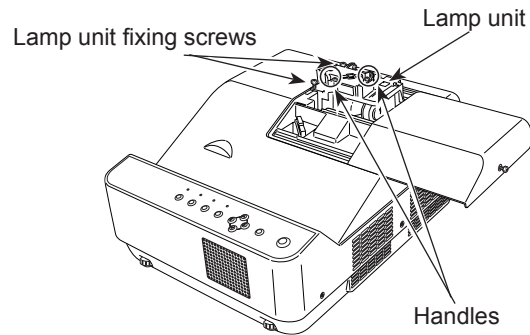
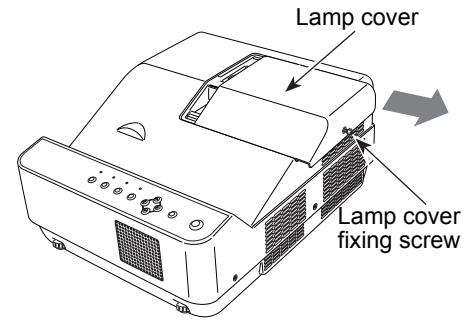

■ Resetting the Lamp Runtime

Be sure to reset the [Lamp runtime] after replacing the lamp unit. (➔page 58 " Lamp runtime reset")

Troubleshooting

Please check following points. For details, see the corresponding pages.

Problem	Cause	Reference page
Power does not turn on.	● The power cord may not be connected.	—
	● No electric supply is at the wall outlet.	—
	● The circuit breakers have tripped.	—
	● Is the <LAMP> indicator, <ON(G)/STANDBY(R)> indicator, or <WARNING > indicator lit or blinking?	27, 61
	● The lamp cover has not been securely installed.	65
No picture appears.	● The video signal input source may not be connected to a terminal properly.	25
	● The input selection setting may not be correct.	33
	● The [Brightness] adjustment setting may be at the minimum setting.	46
	● The input source which is connected to the projector may have a problem.	—
	● The [AV mute] function may be in use.	35
The picture is fuzzy.	● The lens focus may not have been set correctly.	31
	● The projector may not be at the correct distance from the screen.	22
	● The projection window may be dirty.	14
	● The projector may be tilted too much.	—
The color is pale or grayish.	● [Color] or [Tint] adjustment may be incorrect.	46
	● The input source which is connected to the projector may not be adjusted correctly.	—
	● RGB cable is damaged.	—
No sound from the internal speaker	● The input terminals may not have been correctly connected.	25
	● The volume may have been set to the minimum level.	35, 52
	● The [AV mute] function may have been turned on.	35
	● When the AUDIO OUT is plugged-in, the projector's built-in speaker is not available.	19
	● The [Mute] function may have been turned on.	36, 52
The remote control does not operate.	● The batteries may be weak.	—
	● The batteries may not have been inserted correctly.	20
	● The remote control signal receptor on the projector may be obstructed.	17
	● The remote control unit may be out of the operation range.	17
	● Strong light such as fluorescent shine onto the signal receptor.	17
	● When different codes are set on the projector and on the remote control.	57
The control buttons of the projector do not operate.	● The control panel is not available if the control panel is locked at [Key lock] under [Security] of [Setting] section.	57
The picture does not display correctly.	● There may be a problem with the VCR or other signal source.	—
	● A signal which is not compatible with the projector is being input.	73-76
Picture from a computer does not appear.	● The cable may be longer than the optional cable.	—
	● The external video output from a laptop computer may not be correct.	—

Problem	Cause	Reference page
Picture from a HDMI device does not appear or picture is not stable.	● Is the HDMI cable securely connected?	25
	● Turn off the power of the projector and the connected devices. Then turn the power of the projector and the connected devices back on.	—
	● Isn't unsupported signal cable connected?	73-76
No sound is output from a HDMI device.	● Set the sound channel of the attached device to Linear PCM.	—
	● If no audio signal is output during HDMI cable connection, connect the audio cable to COMPUTER 1/COMPONENT AUDIO IN terminal and set to "Computer 1" in "Sound" of "Setting" menu.	55
The image is distorted or runs off.	● Check [PC adj.] or [Screen] and adjust them.	42, 49
The exclamation mark  appears on the screen.	● Your operation is invalid. Operate correctly.	—
3D contents appear as 2D.	● The glasses or the projector are set to 2D mode.	32
3D image is inverted. (3D image is not correct.)	● 3D mode is out of phase. (The data for right/left eyes is inverted.)	32
Image of glasses has flicker.	● Outside of the recommended viewing zone of the glasses.	32
Glasses does not turn on.	<ul style="list-style-type: none"> ● The battery of the glasses is exhausted. ● The projector is not set to 3D mode. 	32

Note

- If the problem persists, after confirming the contents of the table, please consult your dealer.

Technical Information

Serial terminal

The serial connector which is on the connector panel of the projector conforms to the RS-232C interface specification, so that the projector can be controlled by a personal computer which is connected to this connector.

■ Connection

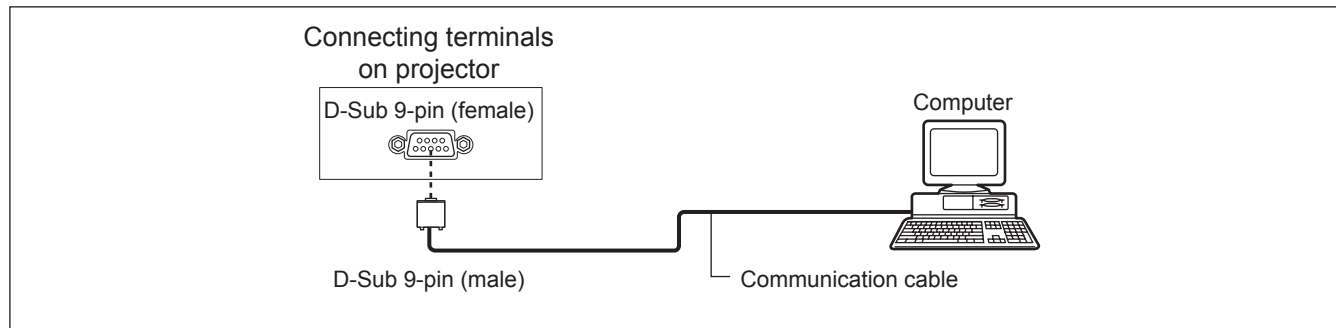

■ Pin assignments and signal names

D-Sub 9-pin (female) Outside view	Pin No.	Signal name	Contents
	①	—	NC
	②	TXD	Transmitted data
	③	RXD	Received data
	④	—	NC
	⑤	GND	Earth
	⑥	—	NC
	⑦	CTS	Connected internally
	⑧	RTS	
	⑨	—	NC

■ Communication conditions

Signal level	RS-232C-compliant
Sync. method	Asynchronous
Baud rate	19 200 bps
Parity	None

Character length	8 bits
Stop bit	1 bit
X parameter	None
S parameter	None

■ Cable specifications

[When connected to a computer]

Projector	1	NC	NC	1	Computer (DTE specifications)
	2			2	
	3			3	
	4	NC	NC	4	
	5			5	
	6	NC	NC	6	
	7			7	
	8			8	
	9	NC	NC	9	

Functional Execution Command

Format

The projector control command is defined as one command line that starts with "C" and ends with carriage return.

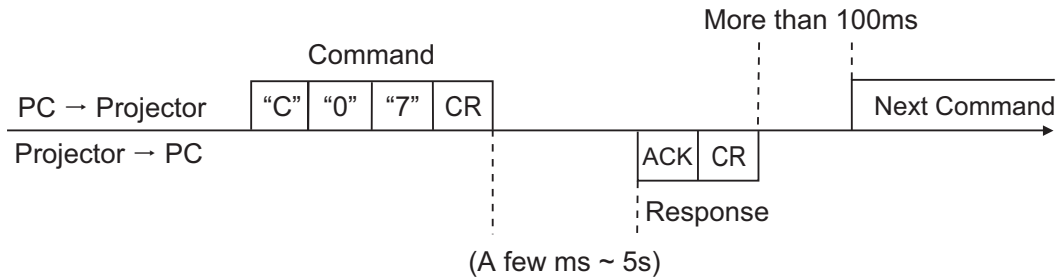

Command	Function
C00	Turn the projector ON
C01	Turn the projector OFF (immediately OFF)
C02	Turn the projector OFF
C04	Select HDMI
C05	Select Computer 1
C06	Select Computer 2
C07	Select Video
C09	Volume +
C0A	Volume -
C0B	Sound mute ON
C0C	Sound mute OFF
C0D	Video mute ON
C0E	Video mute OFF
C0F	Screen Normal Size
C10	Screen Wide Size
C1C	Menu ON
C1D	Menu OFF
C20	Brightness UP
C21	Brightness DOWN
C28	Direct on ON

Command	Function
C29	Direct on OFF
C30	D.ZOOM +
C31	D.ZOOM -
C34	Select S-video
C3A	Pointer RIGHT
C3B	Pointer LEFT
C3C	Pointer UP
C3D	Pointer DOWN
C3F	Enter
C43	Freeze ON
C44	Freeze OFF
C46	Zoom -
C47	Zoom +
C50	Select Computer 1 RGB
C51	Select Computer 1 SCART
C54	Select Computer 1 Component
C89	Auto PC adj.
C8E	Keystone UP
C8F	Keystone DOWN

Technical Information

Status Read Command

Format

The projector control command is defined as one command line that starts with "CR" and ends with carriage return.

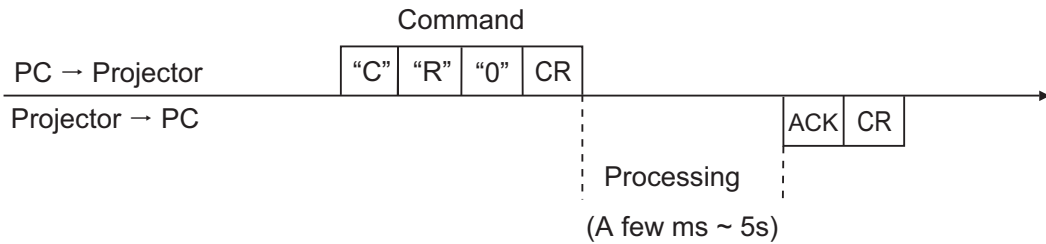

Command	Function	Projector Return	Projector status
CR0	Status Read	00	Power On
		80	Stand-by mode
		40	Countdown
		20	Cooling down
		10	Power Malfunction
		28	Cooling down at the temperature anomaly
		24	Cooling down at Power Management mode
		04	Power Management mode after Cooling down
		21	Cooling down after the projector is turned off when the lamps are out.
		81	Stand-by mode after Cooling down when the lamp is out.
CR6	Temperature Read	%1 %2 %3	%1 = Temperature at Sensor 1 (°C) %2 = Temperature at Sensor 2 (°C) %3 = Temperature at Sensor 3 (°C) (ex.) %1 = 12.3°C, %2 = 23.4°C, %3 = 34.5°C --> The projector displays "12.3 23.4 34.5" (For each sensor, two digit and the tenth place numbers are displayed with a space between each temperature.)
		?	Communication failure

Other terminals

Pin assignments and signal names of <S-VIDEO IN> terminal

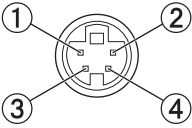
Outside view	Pin No.	Signal names
	①	GND (luminance signal)
	②	GND (color signal)
	③	Luminance signal
	④	Color signal

Pin assignments and signal names of <COMPUTER 1 IN/COMPONENT IN> terminal

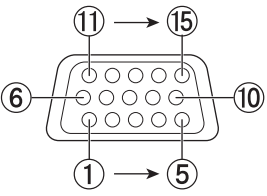
Outside view	Pin No.	Signal names
	①	R/P _R
	②	G/G · SYNC/Y
	③	B/P _B
	⑨	+ 5 V
	⑫	DDC data
	⑬	HD/SYNC
	⑭	VD
	⑮	DDC clock
	④	
	⑤, ⑥, ⑦, ⑧, ⑩, ⑪	

④ : Not assigned
 ⑤ - ⑧, ⑩, ⑪ : GND terminals

Pin assignments and signal names of <COMPUTER 2 IN/MONITOR OUT> terminal

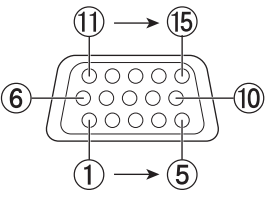
Outside view	Pin No.	Signal names
	①	R
	②	G
	③	B
	⑬	HD/SYNC
	⑭	VD

④, ⑨, ⑪, ⑫, ⑮ : Not assigned
 ⑤ - ⑧, ⑩ : GND terminals

Pin assignments and signal names of <HDMI> terminal

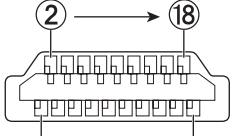
Outside view	Pin No.	Signal names	Pin No.	Signal names
<p>Even-numbered pins ② to ⑱</p>  <p>Odd-numbered pins ① to ⑲</p>	①	T.M.D.S data 2+	⑪	T.M.D.S clock shield
	②	T.M.D.S data 2 shield	⑫	T.M.D.S clock -
	③	T.M.D.S data 2-	⑬	CEC
	④	T.M.D.S data 1+	⑭	—
	⑤	T.M.D.S data 1 shield	⑮	SCL
	⑥	T.M.D.S data 1-	⑯	SDA
	⑦	T.M.D.S data 0+	⑰	DDC/CEC GND
	⑧	T.M.D.S data 0 shield	⑱	+5V
	⑨	T.M.D.S data 0-		Hot plug detection
	⑩	T.M.D.S clock +		

Pin assignments and signal names of <3D SYNC OUT> terminal

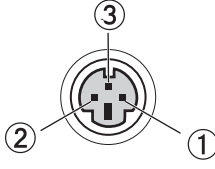
Outside view	Pin No.	Signal names
	①	+5VDC
	②	Ground
	③	Stereo Sync

List of compatible signals

The following table specifies the types of signals compatible with the projectors.

Format : V = VIDEO, S = S-VIDEO, C = COMPUTER, Y = YP_BP_R, H = HDMI

Mode	Display resolution *1 (dots)	Scanning frequency		Dot clock frequency (MHz)	Picture quality *2		PnP*3	3D Display	Format
		H (kHz)	V(Hz)		PT-CW230EA	PT-CX200EA			
NTSC/NTSC 4.43/ PAL-M	720 x 480	15.7	59.9	--	A	A		○	V/S
PAL/PAL-N/SECAM	720 x 576	15.6	60.0	--	A	A		○	V/S
480p	720 x 480	31.469	59.94	25.20	A	A		○	C/Y
480i	720 x 480	15.734	60.00	12.273	A	A		○	
576p	720 x 576	31.25	50.00	29.50	A	A		○	
576i	720 x 576	15.625	50.00	14.75	A	A		○	
720p	1 280 x 720	37.50	50.00	74.25	AA	A		○	
		45.00	60.00	74.25	AA	A		○	
1 080i	1 920 x 1 080i	28.125	50.00	74.25	A	A		○	
		33.75	60.00	74.25	A	A		○	
1 080p	1 920 x 1 080	33.750	30.000	74.25	A	A			
		28.125	25.000	74.25	A	A			
		27.000	24.000	74.25	A	A			
		67.500	60.000	148.50	A	A			
		56.250	50.000	148.50	A	A			
VGA	640 x 480	31.47	59.88	25.149	A	A	○	○	
		37.86	74.38	31.50	A	A			
		37.86	72.81	31.50	A	A	○		
		37.50	75.00	31.50	A	A	○		
		43.269	85.00	36.00	A	A			
	640 x 400	31.47	70.09	25.175	A	A			
	720 x 400	31.47	70.09	28.322	A	A			
SVGA	800 x 600	35.156	56.25	36.00	A	A	○	○	
		37.88	60.32	40.00	A	A	○	○	
		46.875	75.00	49.50	A	A	○		
		53.674	85.06	56.25	A	A			
		48.08	72.19	50.00	A	A	○		
		37.90	61.03	40.02	A	A		○	
		34.50	55.38	36.432	A	A		○	
		38.00	60.51	40.128	A	A		○	
		38.60	60.31	38.60	A	A		○	
		32.70	51.09	32.70	A	A		○	
		76.302	119.972	73.250	A	A		○	
MAC	1 280 x 1 024	80.00	75.08	135.20	A	A			
MAC 13	640 x 480	35.00	66.67	30.24	A	A			
MAC LC13	640 x 480	34.97	66.60	31.33	A	A			
MAC 16	832 x 624	49.72	74.55	57.283	A	A			
MAC 19	1 024 x 768	60.24	75.08	80.01	A	A			
MAC 21	1 152 x 870	68.68	75.06	100.00	A	A			

*1 : "i" added to the resolution value indicates an interlaced signal.

*2 : Picture quality is indicated by the following symbols.

AA: Maximum picture quality can be obtained. A: Signals are converted by the image processing circuit.

*3 : The signal marked with circles (O) can be applied by plug-and-play device.

Technical Information

Mode	Display resolution *1 (dots)	Scanning frequency		Dot clock frequency (MHz)	Picture quality *2		PnP*3	3D Display	Format	
		H (kHz)	V(Hz)		PT-CW230EA	PT-CX200EA				
XGA	1 024 x 768	48.360	60.000	65.000	A	AA	○	○	C	
		68.677	84.977	94.504	A	AA				
		60.023	75.030	78.750	A	AA	○			
		56.476	70.070	75.000	A	AA	○			
		60.31	74.92	79.252	A	AA				
		48.50	60.02	65.179	A	AA		○		
		44.00	54.58	59.129	A	AA		○		
		63.48	79.35	83.41	A	AA				
		62.04	77.07	84.375	A	AA				
		61.00	75.70	81.00	A	AA				
		46.90	58.20	63.03	A	AA		○		
		47.00	58.30	61.664	A	AA		○		
		58.03	72.00	74.745	A	AA				
		97.551	119.989	115.500	A	AA		○		
SXGA	1 152 x 864	64.20	70.40	94.560	A	A			C	
	1 152 x 900	61.20	65.20	92.00	A	A				
		71.40	75.60	105.10	A	A				
	1 280 x 960	61.85	66.00	94.50	A	A				
		60.00	60.00	108.00	A	A		○		
			63.90	60.00	107.35	A	A			○
			63.34	59.98	108.18	A	A			○
			63.74	60.01	109.497	A	A			○
			71.69	67.19	117.004	A	A			
			81.13	76.107	135.008	A	A			
			63.98	60.02	108.00	A	A			○
			79.976	75.025	135.00	A	A			
			63.37	60.01	111.520	A	A			○
			76.97	72.00	130.08	A	A			
63.79			60.18	108.19	A	A		○		
91.146	85.024	157.5	A	A						
SXGA+	1 400 x 1 050	63.970	60.190	107.990	A	A		○	C	
		65.350	60.120	122.850	A	A		○		
		65.120	59.900	122.430	A	A		○		
		64.030	60.010	108.160	A	A		○		
		62.500	58.600	108.000	A	A		○		
		64.744	59.948	101.000	A	A		○		
		65.317	59.978	121.750	A	A		○		

*1 : "i" added to the resolution value indicates an interlaced signal.

*2 : Picture quality is indicated by the following symbols.

AA: Maximum picture quality can be obtained.

A: Signals are converted by the image processing circuit.

*3 : The signal marked with circles (O) can be applied by plug-and-play device.

Technical Information

Mode	Display resolution *1 (dots)	Scanning frequency		Dot clock frequency (MHz)	Picture quality *2		PnP*3	3D Display	Format
		H (kHz)	V (Hz)		PT-CW230EA	PT-CX200EA			
UXGA	1 600 x 1 200	75.00	60.00	162.00	A	A		○	C
		81.25	65.00	175.50	A	A			
		87.5	70.00	189.00	A	A			
		93.75	75.00	202.50	A	A			
		106.250	85.000	229.500	A	A			
WXGA	1 280 x 768	47.776	59.870	79.500	AA	A		○	
		60.289	74.893	102.250	AA	A			
		68.633	84.837	117.500	AA	A			
		97.396	119.798	140.250	AA	A		○	
	1 280 x 800	49.600	60.050	79.360	AA	A		○	
		41.200	50.000	68.557	AA	A		○	
		49.702	59.810	83.500	AA	A	○	○	
		101.563	119.909	146.250	AA	A		○	
1 360 x 768	97.533	119.967	148.250	A	A		○		
1 376 x 768	48.360	60.000	86.670	A	A		○		
WSXGA+1	1 680 x 1 050	65.290	59.954	146.250	A	A			
WXGA+1	1 440 x 900	55.935	59.887	106.500	A	A		○	
WUXGA	1 920 x 1 200	74.556	59.885	193.250	A	A			
		74.038	59.950	154.000	A	A		○	
D-480i	720 x 480i	15.734	59.940	-	A	A		○	
		31.469	119.880	-	A	A		○	
D-576i	720 x 576i	15.625	50.000	-	A	A		○	
		31.250	100.000	-	A	A		○	
D-480p	720 x 480	31.469	59.940	27.000	A	A	○	○	
		62.937	119.880	54.000	A	A		○	
D-576p	720 x 576	31.250	50.000	27.000	A	A	○	○	
		62.500	100.000	54.000	A	A		○	
D-720p	1 280 x 720	37.500	50.000	74.250	AA	A	○	○	
		45.000	60.000	74.250	AA	A	○	○	
		75.000	100.000	148.500	AA	A		○	
		90.000	120.000	148.500	AA	A		○	
D-1 080i	1 920 x 1 080i	28.125	50.000	74.250	A	A	○	○	
		33.750	60.000	74.250	A	A	○	○	
		56.250	100.000	148.500	A	A		○	
		67.500	120.000	148.500	A	A		○	
D-1 080p	1 920 x 1 080	33.750	30.000	74.250	A	A			
		28.125	25.000	74.250	A	A			
		27.000	24.000	74.250	A	A			
		67.500	60.000	148.500	A	A			
		56.250	50.000	148.500	A	A			

*1 : "i" added to the resolution value indicates an interlaced signal.

*2 : Picture quality is indicated by the following symbols.

AA: Maximum picture quality can be obtained.

A: Signals are converted by the image processing circuit.

*3 : The signal marked with circles (O) can be applied by plug-and-play device.

Technical Information

Mode	Display resolution *1 (dots)	Scanning frequency		Dot clock frequency (MHz)	Picture quality *2		PnP*3	3D Display	Format
		H (kHz)	V (Hz)		PT-CW230EA	PT-CX200EA			
D-VGA	640 x 480	31.469	59.940	25.175	A	A	○	○	H
D-SVGA	800 x 600	37.879	60.320	40.000	A	A	○	○	
		76.302	119.972	73.250	A	A		○	
D-XGA	1 024 x 768	43.363	60.000	65.000	A	AA	○	○	
		97.551	119.989	115.500	A	AA		○	
D-SXGA	1 280 x 1 024	63.980	60.020	108.000	A	A		○	
		60.276	58.069	93.067	A	A			
D-SXGA+	1 400 x 1 050	65.350	60.120	122.850	A	A			
		65.120	59.900	122.430	A	A			
		62.500	58.600	108.000	A	A		○	
		64.744	59.948	101.000	A	A		○	
		65.317	59.978	121.750	A	A		○	
D-WXGA	1 360 x 768	97.533	119.967	148.250	A	A		○	
	1 376 x 768	48.360	60.00	86.670	A	A		○	
	1 280 x 768	47.776	59.870	79.500	AA	A		○	
		60.289	74.893	102.250	AA	A			
		68.633	84.837	117.500	AA	A			
	1 280 x 800	97.396	119.798	140.250	AA	A		○	
		49.600	60.050	79.360	AA	A		○	
		41.200	50.000	68.557	AA	A		○	
		49.702	59.810	83.500	AA	A		○	
		101.563	119.909	146.250	AA	A		○	
D-WXGA+	1 440 x 900	55.935	59.887	106.500	A	A		○	
D-WSXGA+	1 680 x 1 050	65.290	59.954	146.250	A	A			

*1 : "i" added to the resolution value indicates an interlaced signal.

*2 : Picture quality is indicated by the following symbols.

AA: Maximum picture quality can be obtained.

A: Signals are converted by the image processing circuit.

*3 : The signal marked with circles (O) can be applied by plug-and-play device.

Note

- The number of display dots is 1 280 x 800 for the PT-CW230EA and 1 024 x 768 for the PT-CX200EA. A signal with a different resolution will be projected after converting the resolution to match the projector display.
- When interlaced signals are connected, flicker may occur on the projected image.

Specifications

Model No.		PT-CW230EA	PT-CX200EA
Power supply		AC100 V - 240 V 50 Hz/60 Hz	
Power consumption		100 V - 240 V 4.5 A-2.2 A, 350 W	
		When [Standby mode] of [Setting] is set to [ECO]: 0.45W	
		When [Standby mode] of [Setting] is set to [Network]: 11.0W	
DLP chip	Size	0.65"(aspect ratio 16 : 10)	0.55"(aspect ratio 4 : 3)
	Display System	One-unit DLP chip, DLP type	
	Number of pixels	1 024 000 pixels (1 280 x 800 dots)	786 432 pixels (1 024 x 768 dots)
Lens		Manual focus F 2.5, f 4.83 mm	
Luminous lamp		275 W UHM lamp	
Light output *1		2 500 lm	2 000 lm
Applicable scanning frequency *2	for RGB signal	Horizontal 15 kHz to 93 kHz, Vertical 50 Hz to 120 Hz	
		Dot clock frequency: 150 MHz or less	
	for YP _B P _R signal	[525i(480i)] Horizontal 15.75 kHz, Vertical 60 Hz [525p(480p)] Horizontal 31.5 kHz, Vertical 60 Hz [750(720)/60p] Horizontal 45 kHz, Vertical 60 Hz [1 125(1 080)/60i] Horizontal 33.75 kHz, Vertical 60 Hz [625i(576i)] Horizontal 15.63 kHz, Vertical 50 Hz [625p(576p)] Horizontal 31.25 kHz, Vertical 50 Hz [750(720)/50p] Horizontal 37.5 kHz, Vertical 50 Hz [1 125(1 080)/50i] Horizontal 28.13 kHz, Vertical 50 Hz ● HD/SYNC and V terminals are not compliant with 3 value composite SYNC	
	for Video signal (including S-video)	Horizontal 15.75 kHz / 15.63 kHz, Vertical 50 Hz / 60 Hz	
	for HDMI signal	525p(480p), 625 p(576p), 750(720)/60p, 750(720)/50p, 1 125(1 080)/60p, 1 125(1 080)/50p, 1 125(1 080)/60i, 1 125(1 080)/50i ● Displayable resolution: VGA to WSXGA+ (non-interlace) ● Dot clock frequency: up to 150 MHz	
Color system		7 (NTSC, NTSC4.43, PAL, PAL-N, PAL-M, SECAM, PAL60)	
Projection size		1.524 m -2.794 m (60"-110")	1.397 m -2.286 m (55"-90")
Screen aspect ratio		16 : 10	4 : 3
Projection scheme		Ceiling/floor, front/rear, vertical upwards/downwards	
Speaker		1 (3.7 cm round-type)	
Maximum usable volume output		10W	
Contrast ratio *1		2 000 : 1 (all white / all black)	

*1 : Measurement, measuring conditions and method of notation all comply with ISO21118 international standards.

*2 : For details of video signals that can be projected using this projector, refer to "List of compatible signals".
(➡ pages 73-76)

Specifications

Model No.		PT-CW230EA	PT-CX200EA
Terminals	COMPUTER 1 IN/ COMPONENT IN	1 (D-sub 15 pin female) [RGB signal] 0.7 V [p-p] 75 Ω (When G-SYNC: 1.0 [p-p] 75 Ω HD/SYNC TTL high impedance, automatic positive/negative polarity compatible VD TTL high impedance, automatic positive/negative polarity compatible [YPbPr signal] Y: 1.0 V [p-p] including synchronization signal, PbPr: 0.7 V [p-p] 75 Ω	
	COMPUTER 2 IN/ MONITOR OUT	[RGB signal] 0.7 V [p-p] 75 Ω (When G-SYNC: 1.0 [p-p] 75 Ω HD/SYNC TTL high impedance, automatic positive/negative polarity compatible VD TTL high impedance, automatic positive/negative polarity compatible	
	VIDEO IN	1 (RCA pin jack 1.0 V [p-p] 75 Ω)	
	S-VIDEO IN	1 (Mini DIN 4 pin, Y 1.0 V [p-p], C 0.286 V [p-p] 75 Ω, S1 signal compatible)	
	HDMI IN	1 (HDMI 19 pin, HDCP and Deep color compatible)	
	AUDIO IN	2 (M3 stereo mini jack, 0.5 V [rms], input impedance 22 kΩ and more) 1 (RCA pin jack x 2 (L-R), 0.5 V [rms], input impedance 22 kΩ and more)	
	AUDIO OUT	1 (M3 stereo mini jack, stereo monitor output compatible, 0 V [rms] to 2.0 V [rms] valuable, output impedance 2.2 kΩ and less)	
	SERIAL IN	1 (D-sub 9 pin, RS-232C compliant, for computer control use)	
	LAN	1 (for RJ-45 network connection, PLink compatible,)	
Power cable length		3.0 m (9.8")	
Cabinet		Molded plastic	
Dimensions		Width: 321 mm (12.6") Height: 170 mm (6.69") {178 mm (7.01") (when front adjustable feet shortened)} Depth: 385 mm (15.16") {386 mm (15.2") (excluding protractions)}	
Weight		Approx. 6.2 kg (13.67 lbs.) *3	
Operating environment		Operating environment temperature: 0 °C (32 °F) to 40 °C (104 °F) Operating environment humidity: 20 % to 80 % (no condensation)	
Remote control	Power supply	DC 3 V (battery (AAA/R03 or AAA/LR03 Type) x 2)	
	Operating range	Approx. 5 m (196.9") (when operated directly on top of receptor)	
	Weight	67 g (2.36 ozs.) (including batteries)	
	Dimensions	Width : 52 mm (2.05"), Length : 110 mm (4.33"), Height : 18 mm (0.71")	

*3 : This is an average value. It may differ depending on individual product.

- The part numbers of accessories and separately sold components are subject to change without notice.

Dimensions

<Unit : mm(inch)>

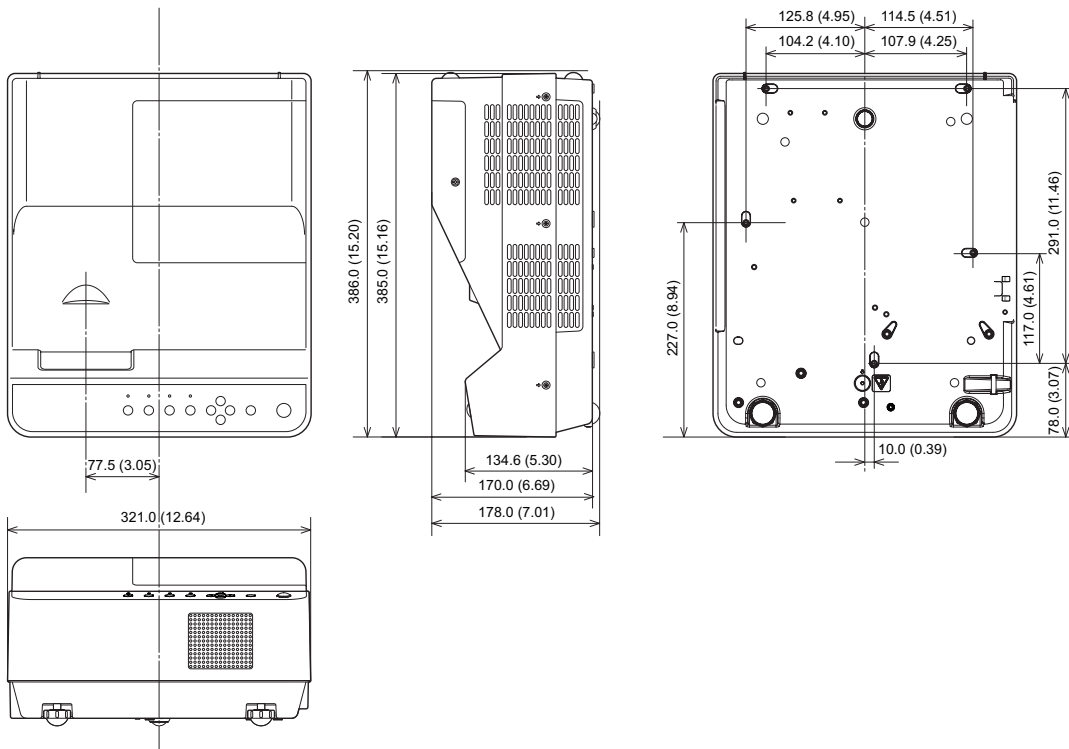

*: Actual dimension may differ by product.

Ceiling mount bracket safeguards

- Installation work of the ceiling mount bracket should only be carried by a qualified technician.
- Even if it is during guaranteed period, the manufacturer is not responsible for any hazard or damage caused by using a ceiling mount bracket which is not purchased from an authorized distributors, or environmental conditions.
- Remove an unused ceiling mount bracket promptly.
- Ensure to use a torque driver and do not use an electrical screwdriver or an impact screwdriver.
- For details, see the work instruction manual packed together with the ceiling mount bracket.
- The model Nos. of the accessories and the parts sold separately are subject to change without notice.
- Make sure the screws on the ceiling mount kit cannot touch the metal parts materials (metallic lath, wire or board) in the ceiling board. Otherwise it may result in fire hazard.

Bottom view

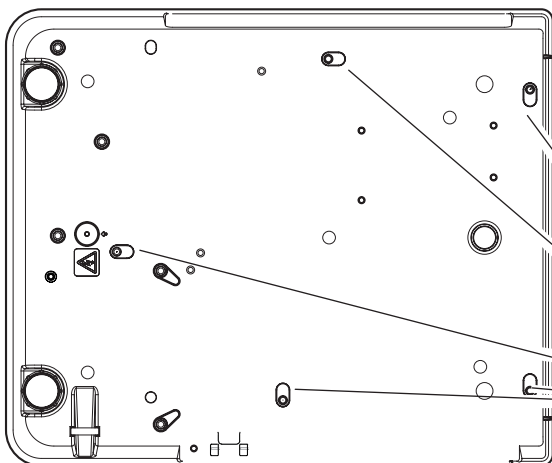

Model No. of ceiling mount bracket:
 ET-PKV100H (for high ceilings)
 ET-PKV100S (for low ceilings)
 Model No. of projector mount base:
 ET-PKC100B
 Model No. of Wall Mount Bracket:
 ET-PKC100W

M4 x 0.7
 16 mm (0.63")
 Torque: $1.2 \pm 0.1 \text{ N} \cdot \text{m}$

Index

Number		
3D setting	54	
A		
About Your Projector.....	17	
Accessories	16	
Adjusting front adjustable feet	24	
AUTO PC adjust.....	42	
Auto setup	53	
AV MUTE.....	35	
B		
Background	54	
Basic operations by using the remote control.....	33	
Brightness.....	46	
C		
Cautions on use.....	14	
Cautions when installing.....	12	
Cautions when transporting.....	12	
CD-ROM.....	16	
Ceiling.....	51	
Cinema	45	
Closed caption.....	56	
Color	46	
Colorboard.....	51	
Color temp.....	46	
Computer System Selection	40	
Connecting the power cord.....	26	
Connections.....	25	
Contrast.....	46	
Control panel	19	
Custom	49	
Custom adj.	50	
D		
Digital zoom.....	50	
Direct on	56	
Direct Power Off function.....	30	
Display.....	54	
Disposal.....	13	
Dynamic.....	45	
F		
Factory default.....	59	
Fan	58	
Fan control.....	58	
For Viewing 3D Contents.....	32	
FREEZE	34	
Full.....	49	
G		
Gamma.....	47	
H		
HDMI setup.....	55	
How to adjust the state of the image	31	
I		
ID numbers	20	
Image adjust.....	46	
Image select	45	
Information.....	60	
Input menu.....	40	
Input search.....	53	
Installing and Removing batteries ..	20	
K		
Keystone.....	34, 50	
L		
LAMP indicator	61	
Lamp runtime.....	58	
Lamp unit.....	64	
Language.....	53	
List of compatible signals	73	
M		
Main menu.....	38	
Maintenance	62	
Managing the indicated problems...61		
Manual PC adjust	43	
Menu Navigation.....	37	
Menu position	53	
Mute.....	52	
N		
Natural wide.....	49	
Noise reduction.....	47	
Normal	49	
O		
ON(G)/STANDBY(R) indicator.....	27	
Optional accessories	16	
Other terminals	71	
P		
PIN code.....	29	
Power management	56	
Precautions for Use	12	
Progressive.....	48	
Projecting.....	31	
Projection distance	22, 23	
Projection method.....	21	
Projector body	18	
R		
Read this first!.....	2	
Real	45	
Rear.....	51	
Remote control	17, 57	
Replacing the Lamp unit.....	65	
Replacing the unit.....	62	
S		
Screen	49	
Screen aspect.....	51	
Screen size and throw distance.....	22	
Security.....	13	
Serial terminal.....	68	
Setting	53	
Setting the ID number.....	20	
Setting up	21	
Sharpness	47	
Side terminals.....	19	
Sound	52	
Specifications	77	
Standard	45	
Standby mode	56	
Sub menu	38	
Switching the input signal	33	
T		
Terminal	55	
Tint.....	46	
Troubleshooting	66	
True	49	
Turning Off the Projector	30	
Turning On the Projector	28	
V		
Video System Selection.....	41	
Volume.....	52	
W		
WARNING indicator.....	61	
Wide(16:9).....	49	
Z		
Zoom	49, 54	

Information for Users on Collection and Disposal of Old Equipment and used Batteries



These symbols on the products, packaging, and/or accompanying documents mean that used electrical and electronic products and batteries should not be mixed with general household waste. For proper treatment, recovery and recycling of old products and used batteries, please take them to applicable collection points, in accordance with your national legislation and the Directives 2002/96/EC and 2006/66/EC.

By disposing of these products and batteries correctly, you will help to save valuable resources and prevent any potential negative effects on human health and the environment which could otherwise arise from inappropriate waste handling.



For more information about collection and recycling of old products and batteries, please contact your local municipality, your waste disposal service or the point of sale where you purchased the items.

Penalties may be applicable for incorrect disposal of this waste, in accordance with national legislation.



For business users in the European Union

If you wish to discard electrical and electronic equipment, please contact your dealer or supplier for further information.

Cd

Information on Disposal in other Countries outside the European Union

These symbols are only valid in the European Union. If you wish to discard these items, please contact your local authorities or dealer and ask for the correct method of disposal.

Note for the battery symbol (bottom two symbol examples):

This symbol might be used in combination with a chemical symbol. In this case it complies with the requirement set by the Directive for the chemical involved.

Panasonic Corporation

Web Site : <http://panasonic.net/avc/projector/>

© Panasonic Corporation 2012

M0312LH1062 -ST