

## Operating Instructions Basic Manual

LCD Projector Commercial Use

---

Model No. **PT-LB3E**  
**PT-LB2E**  
**PT-LB1E**

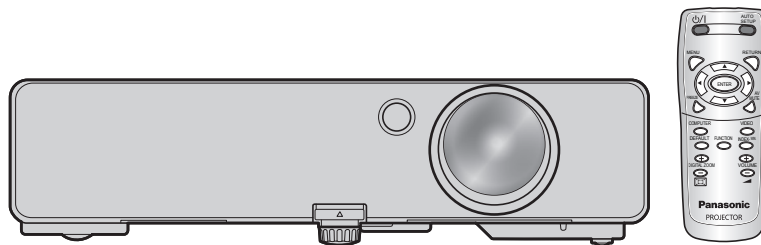

Thank you for purchasing a Panasonic Projector.

- Before operating this product, please read the instructions carefully, and save this manual for future use.
- Before using your projector, be sure to read “Precautions with regard to safety” (pages 7 to 11).
- For network operation, please read the Network Operation Manual.

## Important Safety Notice

### Dear Panasonic Customer:

This instruction booklet provides all the necessary operating information that you might require. We hope it will help you to get the most out of your new product, and that you will be pleased with your Panasonic LCD projector. The serial number of your product may be found on its bottom. You should note it in the space provided below and retain this booklet in case service is required.

**Model number:** PT-LB3E/PT-LB2E/PT-LB1E

---

**Serial number:**

---

**WARNING:** THIS APPARATUS MUST BE EARTHED.

**WARNING:** To prevent damage which may result in fire or shock hazard, do not expose this appliance to rain or moisture.

Machine Noise Information Ordinance 3. GSGV, January 18, 1991: The sound pressure level at the operator position is equal or less than 70 dB (A) according to ISO7779.

**Important Safety Notice (continued)****Information for Users on Collection and Disposal of Old Equipment and used Batteries**

These symbols on the products, packaging, and/or accompanying documents mean that used electrical and electronic products and batteries should not be mixed with general household waste.

For proper treatment, recovery and recycling of old products and used batteries, please take them to applicable collection points, in accordance with your national legislation and the Directives 2002/96/EC and 2006/66/EC.

By disposing of these products and batteries correctly, you will help to save valuable resources and prevent any potential negative effects on human health and the environment which could otherwise arise from inappropriate waste handling.



For more information about collection and recycling of old products and batteries, please contact your local municipality, your waste disposal service or the point of sale where you purchased the items.

Penalties may be applicable for incorrect disposal of this waste, in accordance with national legislation.

**For business users in the European Union**

If you wish to discard electrical and electronic equipment, please contact your dealer or supplier for further information.



Cd

**Information on Disposal in other Countries outside the European Union**

These symbols are only valid in the European Union. If you wish to discard these items, please contact your local authorities or dealer and ask for the correct method of disposal.

**Note for the battery symbol (bottom two symbol examples):**

This symbol might be used in combination with a chemical symbol. In this case it complies with the requirement set by the Directive for the chemical involved.

**Important Safety Notice (continued)****WARNING:**

1. Remove the plug from the wall outlet when this unit is not in use for a prolonged period of time.
2. To prevent electric shock, do not remove cover. No user serviceable parts inside. Refer servicing to qualified service personnel.
3. Do not remove the earthing pin on the power plug. This apparatus is equipped with a three prong earthing-type power plug. This plug will only fit an earthing-type wall outlet. This is a safety feature. If you are unable to insert the plug into the wall outlet, contact an electrician. Do not defeat the purpose of the earthing plug.

**CAUTION:** To assure continued compliance, follow the attached installation instructions, which includes using the provided power cord and shielded interface cables when connecting to computer or peripheral device. Any unauthorized changes or modifications to this equipment will void the user's authority to operate.

**Pursuant to at the directive 2004/108/EC, article 9(2)**  
**Pursuant to at the directive 2005/32/EC amended by 2008/28/EC, article 14**  
**Panasonic Testing Center**  
**Panasonic Service Europe, a division of Panasonic Marketing Europe GmbH**  
**Winsbergring 15, 22525 Hamburg, F.R. Germany**

EEE Yönetmeliğine Uygundur.  
EEE Complies with Directive of Turkey.

## TABLE OF CONTENTS

### Essential information

Important Safety Notice .....	2
Precautions with regard to safety .....	7

### Preparation

Start-up display .....	12
Details of your projector .....	13

### Getting started

Set up your projector .....	16
Connections .....	18

### Basic operations

Turn the projector ON or OFF .....	20
Project an image .....	24
Remote control operation .....	25

### Settings

Menu operation .....	28
<b>PICTURE MENU</b> .....	30

<b>POSITION MENU</b> .....	32
<b>LANGUAGE MENU</b> .....	35
<b>DISPLAY OPTION MENU</b> .....	35
<b>PROJECTOR SETUP MENU</b> .....	38
<b>SECURITY MENU</b> .....	42
<b>NETWORK MENU</b> .....	44

### Maintenance

LAMP and TEMP indicators .....	45
Care and replacement .....	46
Ceiling mount bracket safeguards .....	49

### References

Troubleshooting .....	50
Dimensions .....	51
Trademark acknowledgements .....	51
Technical information .....	52
Specifications .....	55
Index .....	57
Removal of spacer at rear adjuster .....	58

### ***Longer lamp life***

*The lamp replacement cycle is longer than the former model. (⇒ page 47)*

Approx. 3 000 hours (PT-LB90NTE)



Approx. 5 000 hours (PT-LB3E/PT-LB2E/PT-LB1E)

### ***Standby power reduction***

The standby power has been immensely reduced compared to the previous model.

Approx. 0.9 W (PT-LB90NTE)



Approx. 0.4 W (PT-LB3E/PT-LB2E/PT-LB1E)  
(Standby mode: In "ECO")

### ***User logo display function***

You can project your company's logo when projection starts. (⇒ page 36)

## Precautions with regard to safety

### WARNING

#### POWER

**The wall outlet or the circuit breaker shall be installed near the equipment and shall be easily accessible when problems occur. If the followings problems occur, cut off the power supply immediately.**

Continued use of the projector in these conditions will result in fire or electric shock.

- If foreign objects or water get inside the projector, cut off the power supply.
- If the projector is dropped or the cabinet is broken, cut off the power supply.
- If you notice smoke, strange smells or noise coming from the projector, cut off the power supply.

Please contact an Authorized Service Center for repairs, and do not attempt to repair the projector yourself.

**During a thunderstorm, do not touch the projector or the cable.**

Electric shocks can result.

**Do not do anything that might damage the power cord or the power plug.**

If the power cord is used while damaged, electric shocks, short-circuits or fire will result.

- Do not damage the power cord, make any modifications to it, place it near any hot objects, bend it excessively, twist it, pull it, place heavy objects on top of it or wrap it into a bundle.

Ask an Authorized Service Center to carry out any repairs to the power cord that might be necessary.

**Insert the power plug securely into the wall outlet.**

If the plug is not inserted correctly, electric shocks or overheating will result.

- Do not use anything other than the provided power cord.
- Do not use the provided power cord for other electrical equipment.
- Do not use plugs which are damaged or wall outlets which are coming loose from the wall.

**Clean the power plug regularly to prevent it from becoming covered in dust.**

Failure to observe this will cause a fire.

- If dust builds up on the power plug, the resulting humidity can damage the insulation.
- If not using the projector for an extended period of time, pull the power plug out from the wall outlet. Pull the power plug out from the wall outlet and wipe it with a dry cloth regularly.

**Do not handle the power plug with wet hands.**

Failure to observe this will result in electric shocks.

**Do not overload the wall outlet.**

If the power supply is overloaded (ex., by using too many adapters), overheating may occur and fire will result.

### ON USE/INSTALLATION

**Do not place liquid containers on top of the projector.**

If water spills onto the projector or gets inside it, fire or electric shocks will result.

If any water gets inside the projector, contact an Authorized Service Center.

**Do not place the projector on soft materials such as carpets or sponge mats.**

Doing so will cause the projector to overheat, which can cause burns, fire or damage to the projector.

**Do not set up the projector in humid or dusty places or in places where the projector may come into contact with oily smoke or steam, ex. a bathroom.**

Using the projector under such conditions will result in fire, electric shocks or components deterioration. Components deterioration (such as ceiling mount brackets) may cause the projector which is mounted on the ceiling to fall down.

**Do not install this projector in a place which is not strong enough to take the full weight of the projector or on top of a surface which is sloped or unstable.**

Failure to observe this will cause projector to fall down or tip over the projector, and severe injury or damage could result.

**Do not place another projector or other heavy objects on top of the projector.**

Failure to observe this will cause the projector to become unbalanced and fall, which could result in damage or injury. The projector will be damaged or deformed.

**Installation work (such as ceiling suspension) should only be carried out by a qualified technician.**

If installation is not carried out and secured correctly it can cause injury or accidents, such as electric shocks.

- Do not use anything other than an Authorized ceiling mount bracket.

**Do not cover the air inlet port or the air outlet port.**

Doing so will cause the projector to overheat, which can cause fire or damage to the projector.

- Do not place the projector in narrow, badly ventilated places such as closets or bookshelves.
- Do not place the projector on cloth or papers, as these materials could be drawn into the air inlet port.

**Do not place your hands or other objects close to the air outlet port.**

Doing so will cause burns or damage your hands or other objects.

- Heated air comes out of the air outlet port. Do not place your hands or face, or objects which cannot withstand heat close to this port.

## Precautions with regard to safety (continued)

### Do not look and place your skin into the lights emitted from the lens while the projector is being used.

Doing so can cause burns or loss of sight.

- Strong light is emitted from the projector's lens. Do not look or place your hands directly into this light.
- Be especially careful not to let young children look into the lens. In addition, turn off the power and disconnect the power plug when you are away from the projector.

### Do not insert any foreign objects into the projector.

Doing so will cause fire or electric shocks.

- Do not insert any metal objects or flammable objects into the projector or drop them onto the projector.

### Never attempt to remodel or disassemble the projector.

High voltages can cause fire or electric shocks.

For any inspection, adjustment and repair work, please contact an Authorized Service Center.

### Do not project an image with the supplied lens cover attached.

Doing so can cause fire.

## ACCESSORIES

### Do not use or handle the batteries improperly, and refer to the following.

Failure to observe this will cause burns, batteries to leak, overheat, explode or catch fire.

- Do not use unspecified batteries.
- Use manganese batteries but not rechargeable batteries.
- Do not disassemble dry cell batteries.
- Do not heat the batteries or place them into water or fire.
- Do not allow the + and – terminals of the batteries to come into contact with metallic objects such as necklaces or hairpins.
- Do not store batteries together with metallic objects.
- Store the batteries in a plastic bag and keep them away from metallic objects.
- Make sure the polarities (+ and –) are correct when inserting the batteries.
- Do not use a new battery together with an old battery or mix different types of batteries.
- Do not use batteries with the outer cover peeling away or removed.
- Remove the empty batteries from the remote control at once.
- Insulate the battery using tape or something similar before disposal.

### Do not allow children to reach the AAA/R03 battery.

- The battery can cause personal injury if swallowed.
- If swallowed, seek medical advice immediately.

### If the battery fluid leaks, do not touch it with bare hands, and take the following measures if necessary.

- Battery fluid on your skin or clothing could result in skin inflammation or injury. Rinse with clean water and seek medical advice immediately.
- Battery fluid coming in contact with your eyes could result in loss of sight. In this case, do not rub your eyes. Rinse with clean water and seek medical advice immediately.

### Do not disassemble the lamp unit.

If the lamp breaks, it could cause injury.

### Lamp replacement

The lamp has high internal pressure. If improperly handled, an explosion and severe injury or accidents will result.

- Replacement of the lamp should be carried out by a qualified technician.
- The lamp can easily explode if struck against hard objects or dropped.
- Before replacing the lamp, be sure to disconnect the power plug from the wall outlet. Electric shocks or explosions can result if this is not done.
- When replacing the lamp, allow it to cool for at least one hour before handling it otherwise it can cause burns.

### Do not allow infants or pets to touch the remote control unit.

- Keep the remote control unit out of the reach of infants and pets after using it.

## CAUTION

### POWER

### When disconnecting the power cord, be sure to hold the power plug and power connector.

If the power cord itself is pulled, the lead will become damaged, and fire, short-circuits or serious electric shocks will result.

### When not using the projector for an extended period of time, disconnect the power plug from the wall outlet and remove the batteries from the remote control.

### Disconnect the power plug from the wall outlet before carrying out any cleaning.

Electric shocks can result if this is not done.



## Precautions with regard to safety (continued)

### ON USE/INSTALLATION

#### Do not put your weight on this projector.

You could fall or the projector could break, and injury will result.

- Be especially careful not to let young children stand or sit on the projector.

#### Do not place the projector in extremely hot locations.

Doing so will cause the outer casing or internal components to deteriorate, or result in fire.

- Take particular care in locations exposed to direct sunlight or near stoves.

#### Always disconnect all cables before moving the projector.

Moving the projector with cables still attached can damage the cables, which will cause fire or electric shocks to occur.

### ACCESSORIES

#### Do not use the old lamp unit.

If used it could cause lamp explosion.

#### If the lamp has broken, ventilate the room immediately. Do not touch or bring your face close to the broken pieces.

Failure to observe this will cause the user to absorb the gas which was released when the lamp broke and which contains nearly the same amount of mercury as fluorescent lamps, and the broken pieces will cause injury.

If you believe that you have absorbed the gas or that the gas has got into your eyes or mouth, seek medical advice immediately.

Ask your dealer about replacing the lamp unit and check the inside of the projector.

### CAUTIONS WHEN TRANSPORTING

When transporting the projector, the leg adjusters must be housed and do not hold them.

#### When transporting, keep the projector in the provided carrying bag with the lens cover on it.

- Face the lens of the projector in an upward direction and put it gently into the carrying bag.
- Do not put anything other than the projector and its accessories in the carrying bag.

### CAUTIONS WHEN INSTALLING

#### DO NOT USE UNDER THE FOLLOWING CONDITIONS.

- **Do not set up the projector outdoors.**  
The projector is designed for indoor use only.
- **Avoid setting up in places which are subject to vibration or shocks.**  
If the projector is installed in a place where vibrations are transmitted or mounted in a car or a vessel, vibrations or impacts will result in damage to the internal parts, causing failure. Install the product in a place free from vibrations and impacts.
- **Avoid setting up in places which are subject to sudden temperature changes, such as near an air conditioner or lighting equipment.**  
Failure to observe this will result in malfunctions or the lamp life will be shortened.  
See "TEMP INDICATOR" on page 45.
- **Avoid setting up in places which are near high-voltage power lines or near motors.**  
The product will be exposed to interference if it is installed in the vicinity of high-voltage electrical power lines or power sources.
- **Do not install the projector at elevations higher than 2 700 m (8 858 ft) above sea level.**  
If using this projector at high elevations 1 400 - 2 700 m (4 593 - 8 858 ft) above sea level, set the **HIGH ALTITUDE MODE to ON.**  
If using this projector at elevations lower than 1 400 m (4 593 ft) above sea level, set the **HIGH ALTITUDE MODE to OFF.**  
Failure to observe this will result in malfunctions or the lamp life or life of other components will be shortened.

#### BE SURE TO ASK A SPECIALIZED TECHNICIAN WHEN INSTALLING THE PRODUCT TO A CEILING.

If the product is to be installed hanging from the ceiling, purchase an optional hanging attachment (Model No. ET-PKB2). Please call a specialized technician or contact an Authorized Service Center for installation.

### LENS FOCUS

Do not adjust the lens focus in the initial period after switching the projector on. The high clarity projector lens is thermally affected by the light from the light source, making the focus unstable in the period just after switching on. Please allow a warm-up time of at least 30 minutes before adjusting the lens focus.

## Precautions with regard to safety (continued)

### CAUTIONS ON USE

#### IN ORDER TO GET THE PICTURE QUALITY

Draw curtains or blinds over windows and turn off any lights near the screen to prevent outside light or light from indoor lamps from shining onto the screen. Depending on where the projector is used, air exhaust vents or the warm air from air conditioning can cause a shimmering effect on the screen. For this reason, take care not to shield the air exhaust vents and consider the direction of the air flowing from air conditioning.

#### DO NOT TOUCH THE SURFACE OF THE PROJECTOR LENS WITH YOUR BARE HAND.

If the surface of the lens becomes dirty from fingerprints or anything else, this will be magnified and projected onto the screen. Please put the standard lens cover on the projector when you do not use it.

#### DO NOT MOVE THE PROJECTOR WHILE IT IS OPERATING OR SUBJECT IT TO VIBRATION OR IMPACT.

The service life of its internal components will be shortened.

#### THE PROJECTOR HAS A HIGH PRESSURE MERCURY LAMP THAT IS CHARACTERIZED AS FOLLOWS:

- The brightness of the lamp will decrease over time.
- The lamp may explode or shorten the lamp life by shocks or chipping damage.
- In rare cases, it may burst shortly after the first use.
- The possibility of its bursting increases when the lamp is used beyond the replacement time.
- If the lamp bursts, gas inside the lamp is released in the form of smoke.
- The life of a mercury lamp varies according to the individual difference or conditions of use.
- In particular, turning the power on and off frequently and/or repeatedly as well as continuous use for 10 hours will greatly affect the life cycle. Provide a lamp for replacement in advance.

#### CONNECTION TO EXTERNAL DEVICE

When connecting the projector to a computer or external device, use the power cord supplied with the corresponding device and a commercially available shielded interface cable.

### OPTICAL COMPONENTS

It may be necessary to replace the optical components such as Liquid crystal panels and Polarizing plates in less than 1 year if using the projector in a high temperature environment or in a very dusty, oily smoke or tobacco smoke environment. For more details, please contact your dealer.

#### LIQUID CRYSTAL PANEL

The Liquid crystal panels are precision-made. Note that in rare cases, pixels of high precision could be missing or always lit, but this is not a malfunction. Do not project the same image for long periods of time, as this may remain as an afterimage on the liquid crystal panel. Display the white screen test pattern for more than an hour to remove it. See "TEST PATTERN" on page 41.

### SECURITY

#### TAKE SAFETY MEASURES AGAINST FOLLOWING INCIDENTS.

- Personal information being leaked via this product.
- Unauthorized operation of this product by a malicious third party.
- Interfering or stopping of this product by a malicious third party.

#### SECURITY INSTRUCTION

- The connecting network must be secured by firewall or others.
- Change your password regularly.
- Do not use a password that is simple to guess.
- Panasonic and its affiliate companies would never directly inquire about your password.
- Do not share your password with the general public.
- Set a password, and place restrictions on the users who can log in.

**Precautions with regard to safety (continued)****CLEANING AND MAINTENANCE****ASK AN AUTHORIZED SERVICE CENTER TO CLEAN THE INSIDE OF THE PROJECTOR AT LEAST ONCE A YEAR.**

If dust is left to build up inside the projector without being cleaned out, it can result in fire or problems with operation. It is a good idea to clean the inside of the projector before the season when humid weather arrives.

Ask your nearest Authorized Service Center to clean the projector when required.





Please discuss with the Authorized Service Center regarding cleaning costs.

**DISPOSAL**

When discarding this product, please contact your local authorities or dealer and ask for the correct method of disposal.

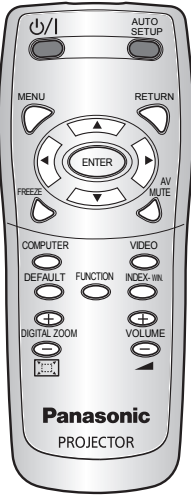
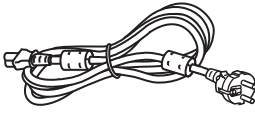
**SUPPLIED ACCESSORIES**

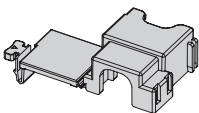
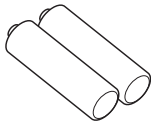
Make sure that the following accessories are provided with your projector.

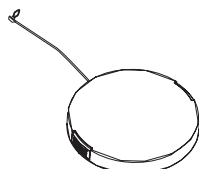
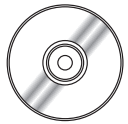
<p>Remote control (×1) (N2QAYA000011)</p> 	<p>Power cord (×1) (K2CM3YY00015)</p> 	<p>RGB signal cable (×1) 1.8 m (5' 10") (K1HY15YY0009)</p> 
	<p>Power cord secure lock (×1) (TTRA0185)</p> 	<p>AAA/R03 batteries for Remote control (×2)</p> 
<p>Carrying bag (×1) (TPEP033)</p> 	<p>Lens cover (×1) (TKKL5499) (Attached to the projector by default.)</p> 	<p>CD-ROM (×1) (TXFQB02VKN5)</p> 

**NOTE:**

- The protectors for the enclosed products, such as a plug cover or foam cartons, must be handled appropriately.
- Contact an Authorized Service Center for any lost accessories.
- Keep the accessories away from children.
- The model Nos. of the accessories and parts sold separately are subject to change without notice.

# Start-up display

The **LANGUAGE** and **INITIAL SETTING** menu will be displayed when the projector is turned on for the first time or after it has been initialized. (⇒ page 41)

Navigate the **DISPLAY OPTION** menu to set the menus in accordance to its application and environment settings.

**NOTE:**

- When the projector is turned on for the first time, you may be required to adjust the “zoom ring” and “focus ring” (⇒ page 13) on the top of the projector body to make the menu screen clearer.  
For details, see POSITION THE IMAGE. (⇒ page 24)

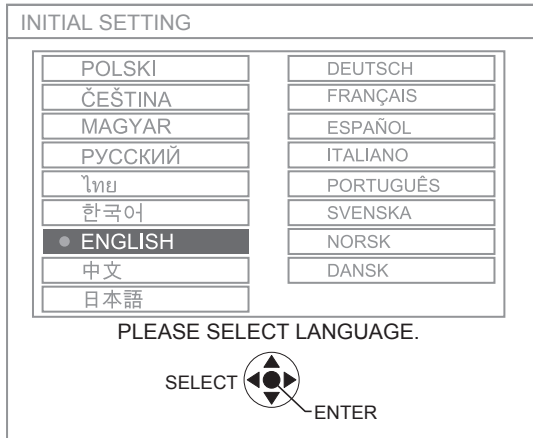

## LANGUAGE

- 1**  **To select the desired language.**



- 2**  **To proceed to INITIAL SETTING menu.**

## INITIAL SETTING

- 1**  **To select the desired menu.**  
→ INSTALLATION  
→ HIGH ALTITUDE MODE
- 2**  **To change the settings in the menu.**

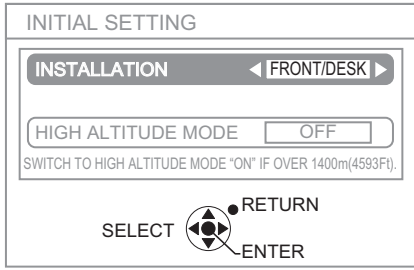

INSTALLATION (⇒ page 17, 39)	
<b>FRONT/DESK</b>	Put it on a desk or floor and project from the front
<b>FRONT/CEILING</b>	Mount it on the ceiling with a ceiling mount bracket (sold separately) and project from the front
<b>REAR/DESK</b>	Put it on a desk or floor and project from the rear (a translucent screen is required)
<b>REAR/CEILING</b>	Mount it on the ceiling with a ceiling mount bracket (sold separately) and project from the rear (a translucent screen is required)

HIGH ALTITUDE MODE (⇒ page 9, 39)	
<b>OFF</b>	Use in normal environment (below 1 400 m (4 593 ft) above sea level)
<b>ON</b>	Use at high altitude (at 1 400 - 2 700 m (4 593 - 8 858 ft) above sea level)

- 3** 

- NOTE:**
- To return to **LANGUAGE** menu, press **[RETURN]** in **INITIAL SETTING** menu.

## Details of your projector

### PROJECTOR'S MAIN UNIT

#### Top and front view

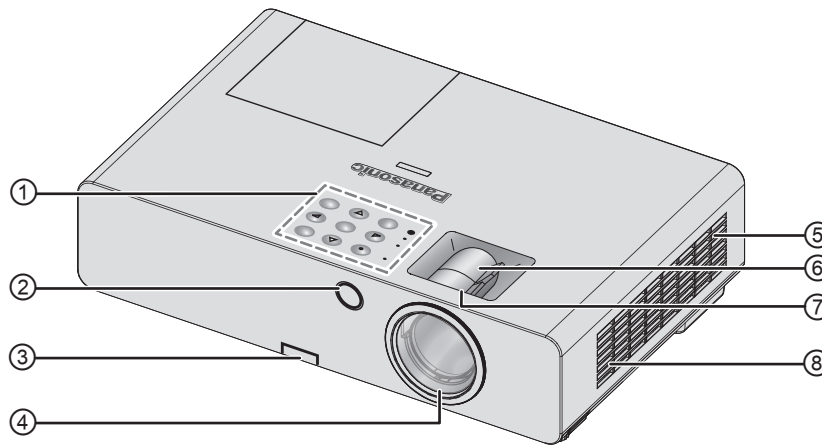

- ① **Control Panel / Indicators**
- ② **Remote control signal receptor**
- ③ **Leg adjuster button** (⇒ page 24)
- ④ **Projection lens**
- ⑤ **Air filter compartment** (⇒ page 46)
- ⑥ **Zoom ring** – To adjust the size of projection. (⇒ page 24)
- ⑦ **Focus ring** – To adjust the focus. (⇒ page 24)
- ⑧ **Air intake port**

#### Control Panel / Indicators

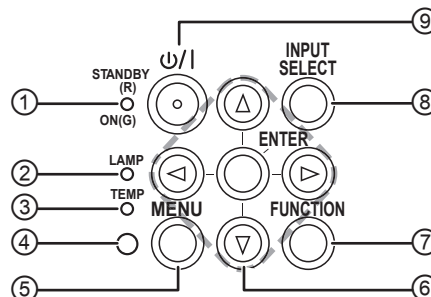

- ① Indicate the power supply's status. (⇒ page 21)
- ② Indicate the lamp unit's status. (⇒ page 45)
- ③ Indicate the temperature's status. (⇒ page 45)
- ④ Ambient Luminance sensor (ALS).
- ⑤ Display the Main menu.
- ⑥ Navigate through the menus. Confirm selection.
- ⑦ Create shortcut assigned to certain selected function. (⇒ page 27, 40)
- ⑧ Switch the input connections. (⇒ page 24)
- ⑨ Switch between standby mode and projection mode. (⇒ page 22)

## Details of your projector (continued)

### Rear and bottom view

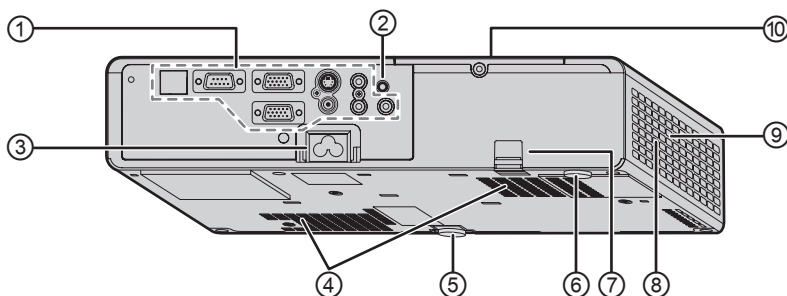

① **Terminals**

② **Remote control signal receptor**

③ **AC IN**

Connect the power cord to supply electric power to the projector. (⇒ page 20)

④ **Air intake port**

⑤ **Front leg adjuster**

To adjust the projection angle. (⇒ page 24)

⑥ **Rear leg adjuster**

To adjust the projection angle. (⇒ page 24)

⑦ **Burglar hook port**

Attach a commercial burglar prevention cable.

⑧ **Air outlet port**

Hot air comes out from this opening.

⑨ **Speaker**

⑩ **Lamp unit compartment** (⇒ page 48)

### NOTE:

- Do not connect any power cable other than the attached one.
- Do not cover the ventilation openings of the air intake port or air outlet port.

### Terminals

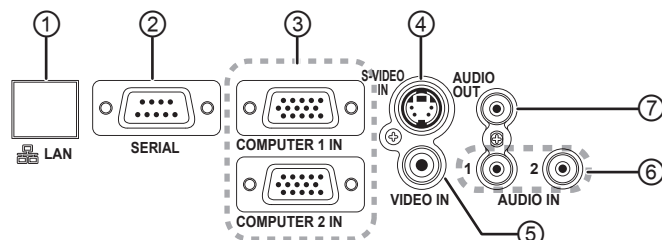

① Connect to a network cable.  
(See "Network Operation Manual".)

② Connect to a computer to control the projector's operation.  
(⇒ page 19, 53)

③ Connect to a computer or YP<sub>B</sub>P<sub>R</sub> signal cable.  
(⇒ page 19)

④ Connect to an S-VIDEO signal cable.  
(⇒ page 18)

⑤ Connect to a VIDEO signal cable.  
(⇒ page 18)

⑥ Connect audio cables for inputting audio signal.  
(⇒ page 19)

⑦ Connect an audio cable for audio signal output to the connected equipment. If it is connected to this terminal, no sound comes out of the built-in speaker.  
(⇒ page 18, 19)

### NOTE:

- Do not place your hands or other objects close to the air outlet port as this may cause damage or injury.
- Do not place your hands or face, or objects which cannot withstand heat near the air outlet port. Hot air comes out from this port.

## Details of your projector (continued)

### PROJECTOR'S REMOTE CONTROL

#### Top and rear view

Remote control  
signal emitters

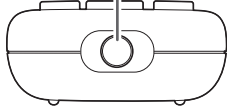

#### Installing/removing batteries

Press the tab and lift up the cover.

Insert the batteries according to the polarity diagram indicated inside or remove.

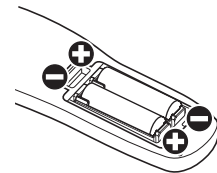
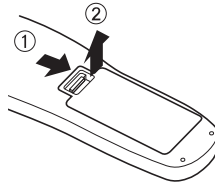

Use only manganese batteries.

#### Front view

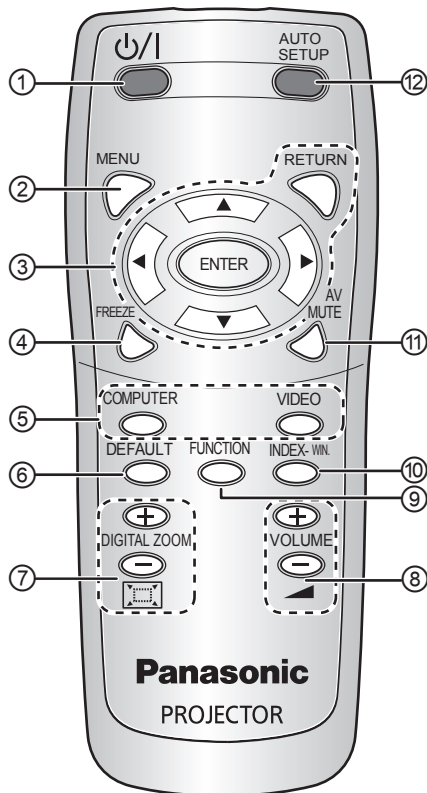

- ① **POWER**  
Switch between standby mode and projection mode. (⇒ page 22, 23)
- ② Display the Main menu. (⇒ page 29)
- ③ Navigate through the menus with [**▲▼◀▶**] and confirm the selection with [**ENTER**]. (⇒ page 28)
- ④ Capture the projected image as a frozen picture. (⇒ page 25)
- ⑤ Switch the required input signal button to select. (⇒ page 25)
- ⑥ Reset some of the settings to the factory default settings. (⇒ page 26)
- ⑦ Control the zoom size. (⇒ page 27)
- ⑧ Control speaker volume. (⇒ page 26)
- ⑨ Create shortcut assigned to certain selected function. (⇒ page 27, 40)
- ⑩ Display frozen image while the display of subsequent images continues. (⇒ page 26)
- ⑪ Turn off the projection temporarily. (⇒ page 25)
- ⑫ Detect the input signal.  
Adjust the settings of **SHIFT**, **DOT CLOCK** and **CLOCK PHASE** in the **POSITION** menu automatically for **COMPUTER** signals. (⇒ page 25)

#### NOTE:

- Do not drop the remote control.
- Avoid contact with liquids or moisture.
- Do not attempt to modify or disassemble the remote control.
- Do not let strong light shine onto the signal receptor which will cause a malfunction.
- The remote control operates within the range of 7 m (23' 0"), approximately ±30 ° vertically and horizontally from the projector avoiding any obstacles.
- The operating range may differ due to the screen material and may not be effective with a translucent screen.

## Set up your projector

### SCREEN SIZE AND THROW DISTANCE

You can adjust the projection size with 1.2× zoom lens. Calculate and define the throw distance as follows.

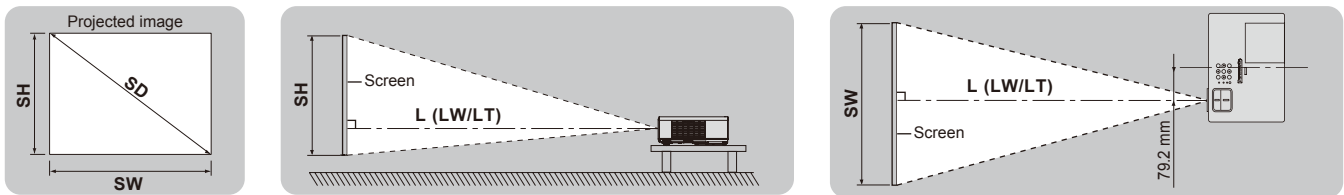

(All measurements below are approximate and may differ slightly from the actual measurements.)

Projection size	For 4:3 aspect ratio				For 16:9 aspect ratio			
	Minimum distance (LW)		Maximum distance (LT)		Minimum distance (LW)		Maximum distance (LT)	
	PT-LB3/ PT-LB2	PT-LB1	PT-LB3/ PT-LB2	PT-LB1	PT-LB3/ PT-LB2	PT-LB1	PT-LB3/ PT-LB2	PT-LB1
0.84 m (33")	—	—	1.1 m (3' 7")	1.1 m (3' 7")	—	—	1.2 m (3' 11")	1.3 m (4' 3")
1.02 m (40")	1.1 m (3' 7")	1.2 m (3' 11")	1.4 m (4' 7")	1.4 m (4' 7")	1.3 m (4' 3")	1.3 m (4' 3")	1.5 m (4' 11")	1.5 m (4' 11")
1.27 m (50")	1.4 m (4' 7")	1.5 m (4' 11")	1.7 m (5' 6")	1.8 m (5' 9")	1.6 m (5' 3")	1.6 m (5' 3")	1.9 m (6' 2")	1.9 m (6' 2")
1.52 m (60")	1.7 m (5' 6")	1.8 m (5' 9")	2.1 m (6' 10")	2.1 m (6' 10")	1.9 m (6' 2")	1.9 m (6' 2")	2.3 m (7' 6")	2.3 m (7' 6")
1.78 m (70")	2.0 m (6' 6")	2.1 m (6' 10")	2.4 m (7' 10")	2.5 m (8' 2")	2.2 m (7' 2")	2.3 m (7' 6")	2.6 m (8' 6")	2.7 m (8' 9")
2.03 m (80")	2.3 m (7' 6")	2.4 m (7' 10")	2.8 m (9' 2")	2.8 m (9' 2")	2.5 m (8' 2")	2.6 m (8' 6")	3.0 m (9' 10")	3.1 m (10' 2")
2.29 m (90")	2.6 m (8' 6")	2.7 m (8' 9")	3.1 m (10' 2")	3.2 m (10' 6")	2.9 m (9' 6")	2.9 m (9' 6")	3.4 m (11' 1")	3.5 m (11' 5")
2.54 m (100")	2.9 m (9' 6")	3.0 m (9' 10")	3.5 m (11' 5")	3.5 m (11' 5")	3.2 m (10' 6")	3.3 m (10' 8")	3.8 m (12' 5")	3.9 m (12' 8")
3.05 m (120")	3.5 m (11' 5")	3.6 m (11' 8")	4.2 m (13' 9")	4.3 m (14' 1")	3.8 m (12' 5")	3.9 m (12' 8")	4.6 m (15' 1")	4.7 m (15' 4")
3.81 m (150")	4.4 m (14' 4")	4.5 m (14' 8")	5.2 m (17' 0")	5.3 m (17' 4")	4.8 m (15' 7")	4.9 m (16' 1")	5.7 m (18' 8")	5.8 m (19' 0")
5.08 m (200")	5.8 m (19' 0")	6.0 m (19' 7")	7.0 m (22' 11")	7.1 m (23' 3")	6.3 m (20' 8")	6.6 m (21' 7")	7.6 m (24' 11")	7.8 m (25' 6")
6.35 m (250")	7.3 m (23' 11")	7.5 m (24' 6")	8.7 m (28' 6")	8.9 m (29' 2")	7.9 m (25' 11")	8.2 m (26' 9")	9.5 m (31' 2")	9.7 m (31' 8")
7.62 m (300")	8.7 m (28' 6")	9.0 m (29' 5")	10.5 m (34' 5")	10.7 m (35' 1")	9.5 m (31' 2")	9.9 m (32' 5")	11.5 m (37' 7")	11.7 m (38' 4")

You can calculate detailed screen dimensions from the "Screen diagonal". The unit of all the calculation results is m. (The results below differ slightly from the actual measurements.)

If the projection size is SD,

		For 4:3 aspect ratio	For 16:9 aspect ratio
Screen height (SH)		$SH (m) = SD (m) \times 0.6$	$SH (m) = SD (m) \times 0.490$
Screen width (SW)		$SW (m) = SD (m) \times 0.8$	$SW (m) = SD (m) \times 0.872$
Minimum distance (LW)	PT-LB3/PT-LB2	$= 1.1496 \times SD (m) - 0.025$	$= 1.2520 \times SD (m) - 0.011$
	PT-LB1	$= 1.1890 \times SD (m) - 0.035$	$= 1.2992 \times SD (m) - 0.041$
Maximum distance (LT)	PT-LB3/PT-LB2	$= 1.3819 \times SD (m) - 0.033$	$= 1.5079 \times SD (m) - 0.035$
	PT-LB1	$= 1.4094 \times SD (m) - 0.035$	$= 1.5394 \times SD (m) - 0.040$

#### NOTE:

- For best projection image quality, install a screen where sunlight or room lightings do not shine directly onto the screen. Close window shades or curtains to block the light and turn off the lightings.
- Do not use the projector at a raised or horizontally tilted position. It may cause the projector to malfunction.  
However, you can tilt the projector's body approximately  $\pm 30^\circ$  vertically and  $\pm 10^\circ$  horizontally.

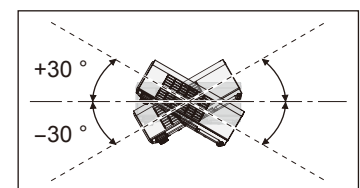

Over tilting may result in shortening the component's life.

- Do not cover the air outlet port and air intake ports or place anything within 50 cm (20") near them as this may cause damage or injury.



## Set up your projector (continued)

### PROJECTION METHOD

See "INSTALLATION" on page 39 to select the projection method.

#### ■ Put it on a desk or floor and project from the front

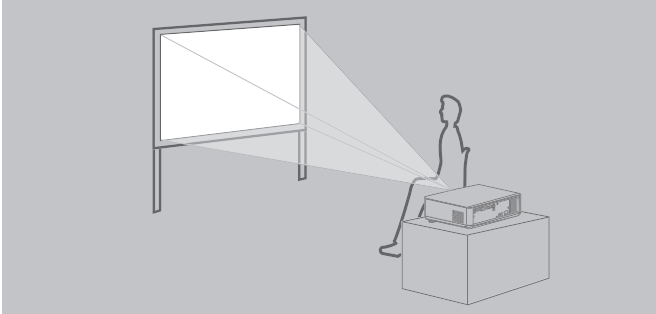

Menu	Method
INSTALLATION	FRONT/DESK

#### ■ Mount it on the ceiling and project from the front

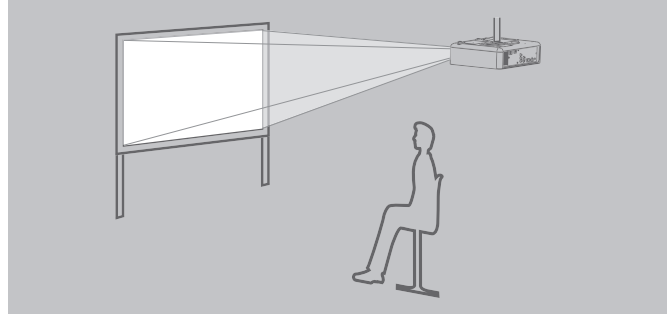

Menu	Method
INSTALLATION	FRONT/CEILING

#### ■ Put it on a desk or floor and project from the rear (Use translucent screen)

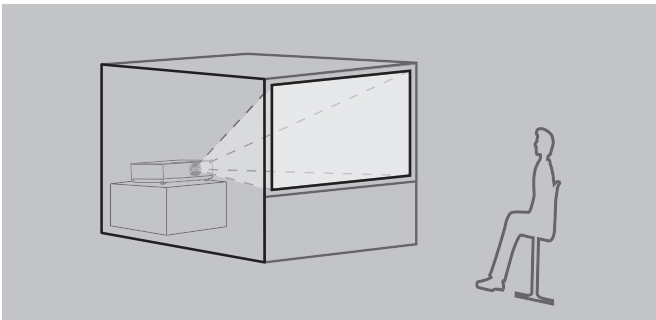

Menu	Method
INSTALLATION	REAR/DESK

#### ■ Mount it on the ceiling and project from the rear (Use translucent screen)

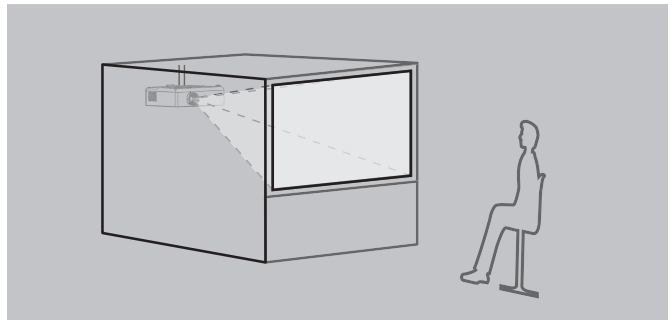

Menu	Method
INSTALLATION	REAR/CEILING

#### NOTE:

- Use the optional ceiling mount bracket (ET-PKB2) when mounting the projector on the ceiling.
- You can adjust the projection angle in the vertical direction by adjusting the leg adjuster button. (⇒ page 24)

## Connections

### Preparations

- Read and follow the operating instructions of each peripheral device and turn the peripheral devices off prior to making any connections.
- Prepare the selected peripheral devices with the connection cables that correspond to the projector's terminals.
- All peripheral devices and cables used for the connections are sold separately unless indicated otherwise.
- If the input signal is affected by signal jitter, the projected image may have poor image quality and timebase correction is effective.
- Confirm the types of video signals, see "LIST OF COMPATIBLE SIGNALS". (⇒ page 52)

### Example: AV equipment

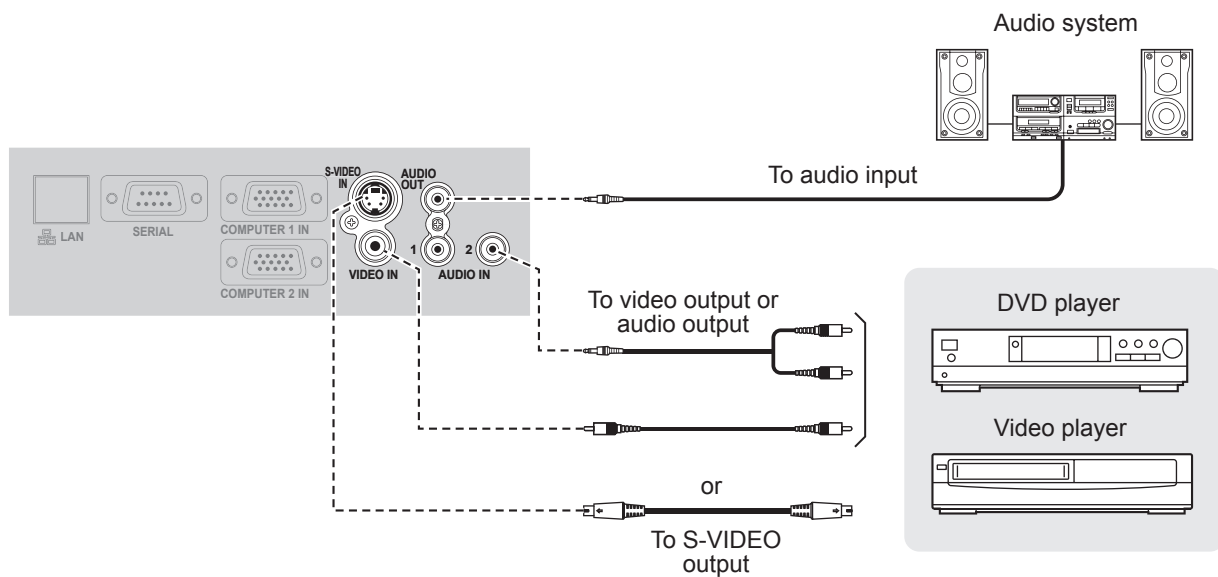

#### NOTE:

- Switch the audio connection manually for more than one AV equipment connections.

## Connections (continued)

### Example: Computers

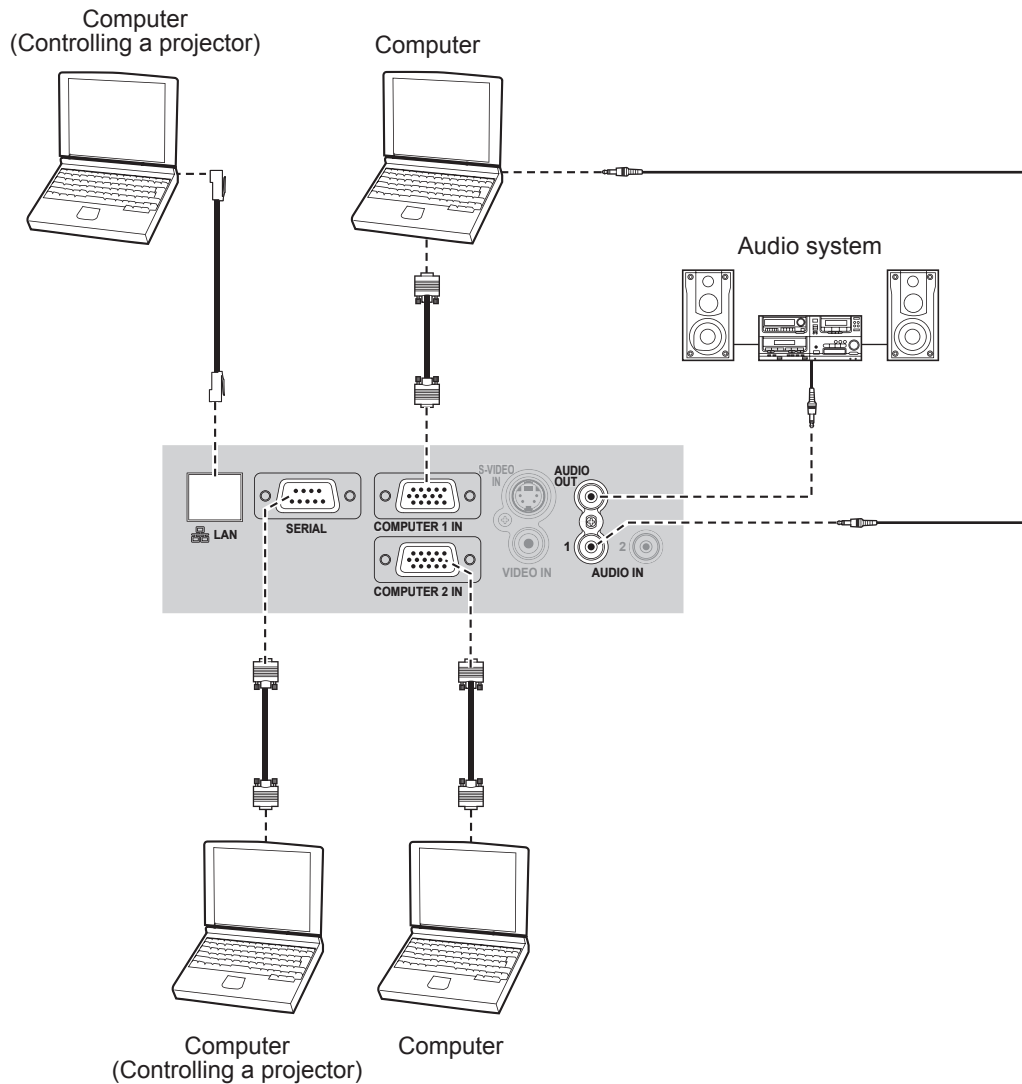

#### NOTE:

- When connecting the RGB signal cable, tighten the fixing screws on the D-Sub (15-pin) connector.
- For the network connection between the projector and computers, see "Network Operation Manual" in the CD-ROM provided.
- Only the RGB signal cable (1 piece) is attached. If any other cables are necessary, purchase them from the market.

## Turn the projector ON or OFF

### POWER CORD

Fix the provided “power cord secure lock” to the power cord on the projector to prevent the cord from coming off.

For details, see “Precautions with regard to safety”. (⇒ pages 7 to 11)

#### Install the “power cord secure lock”

- 1 Push the connector all the way into the AC IN terminal ensuring that the shape of the connector matches that of the terminal.

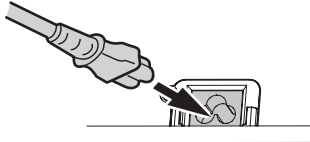

- 2 Align the side of the “power cord secure lock” with the side of the “Rail guide” of the AC IN terminal and slide it in.

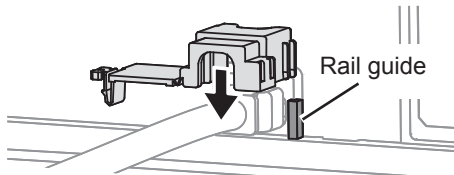

- 3 Latch to the latch catcher and press until it clicks.

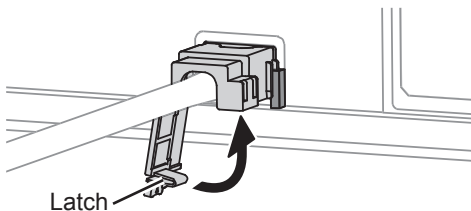

- 4 Connect the power plug to a wall outlet.

#### Detach the “power cord secure lock”

- 1 Unplug the power plug from the wall outlet.
- 2 Depress the latch and slide off the lock.

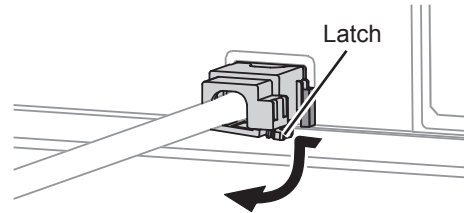

- 3 Slide up the “power cord secure lock” and remove it.

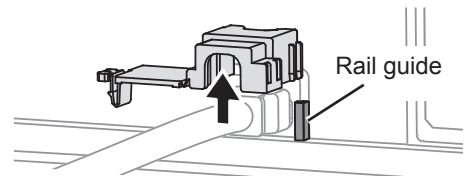

- 4 Hold the connector firmly and detach it from the AC IN terminal.

#### Direct power on function

If the power cord is connected to a wall outlet with INITIAL START UP (PROJECTOR SETUP menu) is set to ON, projection will start even when the control panel is disabled. (⇒ page 39)

#### Direct power off function

You can switch off the electric power supply any time by unplugging the power plug from the wall outlet or by switching off the main power. The internal cooling fan keeps operating using the internal power supply and automatically stops when cooled.

#### NOTE:

- Do not put the projector into the carrying bag with the **POWER** indicator lit.

## Turn the projector ON or OFF (continued)

### POWER INDICATOR

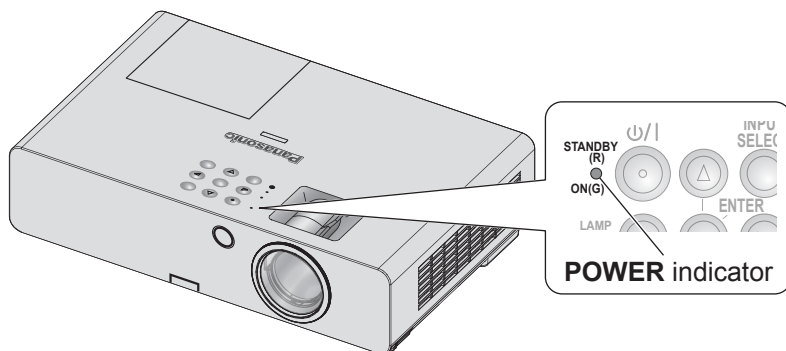

#### POWER indicator

→ shows status of the projector's power

When the **TEMP** indicator flashes, the **POWER** indicator lights red and you cannot turn the projector on.

### POWER indicator status

Indicator status		Status
No illumination or flashing		No power is supplied and the internal cooling fan is not operating.
Red	Lit	The power is turned off (when <b>STANDBY MODE</b> is set to <b>ECO</b> ). If [ <b>POWER</b> ] button is pressed, projection starts.
	Flashing	The power is turned off (when <b>STANDBY MODE</b> is set to <b>NORMAL</b> ). If [ <b>POWER</b> ] button is pressed, projection starts.
Green	Flashing	The power is on and preparing for projection.
	Lit	The projector is projecting.
Orange	Lit	No power supply and the power is preparing for being turned off. It is turned off (The projection is set in <b>STANDBY MODE</b> ) after a while.
	Flashing	The power is switched on again while cooling the lamp and recovering to the projection mode. Recovery may take a while.

#### NOTE:

- When the power is turned off, the internal fan cools the lamp using internal power supply.
- The power is turned on again while cooling the lamp and recovers to the projection mode. Recovery may take a while.
- While the power is turned off (when **STANDBY MODE** is set to **ECO**, the **POWER** indicator is lit red), power of about 0.4 W is consumed.

## Turn the projector ON or OFF (continued)

### TURN THE PROJECTOR ON

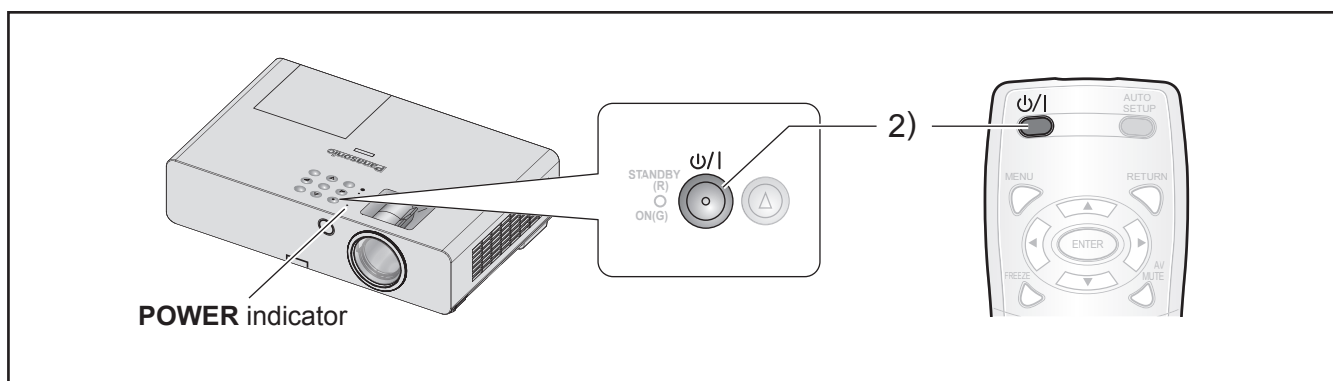

Before switching on the projector, make sure all the other devices are correctly connected and remove the Lens cover. (⇒ page 18)

#### 1 Connect the power cord. (⇒ page 20)

After a while the “power indicator” lights or flashes in red.

#### 2 Press the POWER button.

- **POWER** indicator flashes green several times before it lights up and the **STARTUP LOGO** is displayed. See **STARTUP LOGO** in **DISPLAY OPTION** menu. (⇒ page 36)

#### NOTE:

- Confirm that **CONTROL PANEL** (when operating with the projector body) or **REMOTE CONTROLLER** (when operating with the remote control) under **CONTROL DEVICE SETUP** in the **SECURITY** menu is set to **ENABLE**. (⇒ page 44)  
When setting the **SECURITY** menu, you will be asked to input the password. (⇒ page 42)
- When starting up the projector, some small rattling or tinkling sound may be heard. These are normal and will not affect the performance of the projector.
- When the internal cooling fan is operating, some operational sound may be heard. The loudness of the operational sound depends on the external temperature.
- If **INITIAL START UP (PROJECTOR SETUP)** menu is set to **ON**, the projector starts projecting when the power cord is connected to a wall outlet. (⇒ page 39)
- If the projector is turned on again while the internal cooling fan is still operating by the internal power supply, the display may flicker due to the specifications of the lamp. These are normal and will not affect the performance of the projector.

## Turn the projector ON or OFF (continued)

### TURN THE PROJECTOR OFF

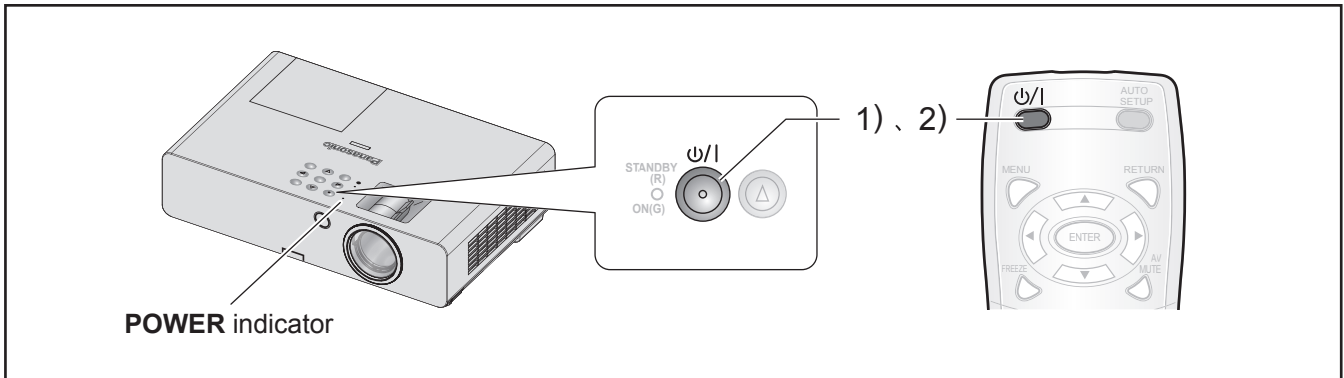

When operating the projector, check the status of the **POWER** indicator. (⇒ page 21)

#### 1 Press the **POWER** button.

A confirmation screen will be displayed – the screen will go off and return to projection if there is no operation for approximately 10 seconds.

#### 2 Press the button again.

The lamp goes off and the projection stops.

- The cooling fan continues its rotation and **POWER** indicator lights orange. Wait until the **POWER** indicator turns red.
- If **STANDBY MODE** is set to **NORMAL**, the **POWER** indicator flashes red. (⇒ page 39)

#### 3 Disconnect the power plug from the wall outlet after the **POWER** indicator lights or flashes in red. (⇒ page 21)

- For urgency, you may disconnect the power plug immediately since the **DIRECT POWER OFF** function is installed.

#### NOTE:

- Confirm that **CONTROL PANEL** (when operating with the projector body) or **REMOTE CONTROLLER** (when operating with the remote control) under **CONTROL DEVICE SETUP** in the **SECURITY** menu is set to **ENABLE**. (⇒ page 44)
- Power can be turned off by pressing [**POWER**] for at least 0.5 seconds.

## Project an image

### Preparations

- Confirm the connections of the peripheral devices (⇒ page 18, 19) and power cord (⇒ page 20).
- Switch on the power (⇒ page 22) to start projecting.
- Select the input signal and adjust the image.

### SELECT THE INPUT SIGNAL

#### 1 Switch on the connected devices.

When playing a connected DVD player, if **SIGNAL SEARCH (DISPLAY OPTION menu)** is set to **ON**, the input signal is detected and projected automatically when the projector is switched on. (⇒ page 37)

- Set the **INPUT GUIDE (DISPLAY OPTION → ON-SCREEN DISPLAY menu)** to **DETAILED**. If the projector cannot detect any input signal, the "Computer connection guide" will be displayed. (⇒ page 35)

#### 2 Select an input signal.

The image selected with any of the **[INPUT SELECT]** button is projected.

#### NOTE:

- Change the settings in the **PICTURE** menu according to the connected device for example DVD, video tape, etc., to be played. (⇒ page 30)
- Confirm the aspect ratio of the screen and image. Select the optimum aspect ratio. (⇒ page 33)

### POSITION THE IMAGE

When setting up the projector for the first time or setting up at a new place, you must perform the following operations.

#### 1 Adjust the vertical angle of the projector.

- Place the projector at the right angle from the screen.

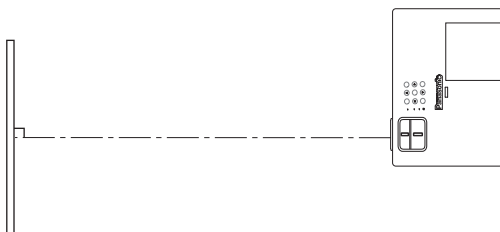

- Press the leg adjuster button **(A)** and adjust the vertical projection angle. Then, adjust the projected image to the center of the screen.

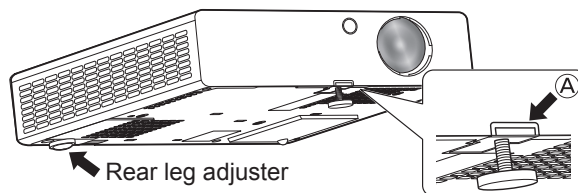

#### 2 Adjust the projection size and focus.

- Turn the zoom and focus rings to adjust the projected image.

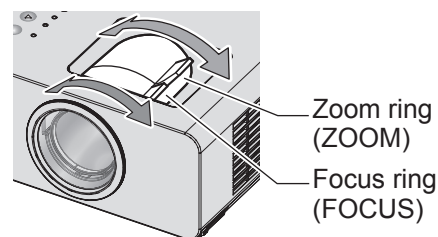

#### NOTE:

- When you adjust the zoom after adjusting the focus, you may need to adjust the focus of the image again.
- If the projected image slants to the right or left, turn the rear leg adjuster to adjust the angle of the projector.
- If keystone distortion occurs, see **KEYSTONE**. (⇒ page 32)



## Remote control operation



### CAPTURE AN IMAGE

You can freeze the projected image and temporarily stop the sound, regardless of the playing condition of the connected device.



Press the button again to cancel it. The image is distorted momentarily when the projection is stopped and restarted.

### STOP THE PROJECTION TEMPORARILY

You can temporarily stop the projection and the sound from the projector.



Press the button again to cancel it.

### SWITCH THE INPUT SIGNAL

You can switch the input signal to be projected.

#### COMPUTER



The options below are displayed each time you press this button.

<b>COMPUTER1</b>	Signal input to <b>COMPUTER1 IN</b> terminal
<b>COMPUTER2</b>	Signal input to <b>COMPUTER2 IN</b> terminal

#### VIDEO



The options below are displayed each time you press this button.

<b>S-VIDEO</b>	Signal input to <b>S-VIDEO IN</b> terminal
<b>VIDEO</b>	Signal input to <b>VIDEO IN</b> terminal

You can confirm the selected input terminal (from the graphical input terminal guide on the upper right of the screen), if **INPUT GUIDE (DISPLAY OPTION → ON-SCREEN DISPLAY)** menu) is set to **DETAILED**. (⇒ page 35)

You can change the input with [**▲▼◀▶**].

It may take some time to change the image after the input signal is switched.

#### NOTE:

- Input a compatible signal shown in the "LIST OF COMPATIBLE SIGNALS". (⇒ page 52)
- For the input terminals, see "Connections". (⇒ page 18)
- The input guide automatically disappears when it is left idle.

Press [**INPUT SELECT**] on the control panel to switch the input in the following order. (⇒ page 13)

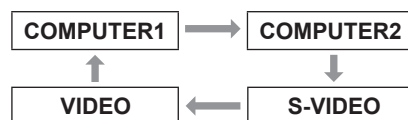

### SET UP THE IMAGE POSITION AUTOMATICALLY

The projector automatically adjusts the **SHIFT**, **DOT CLOCK** and **CLOCK PHASE** when an RGB signal is input.

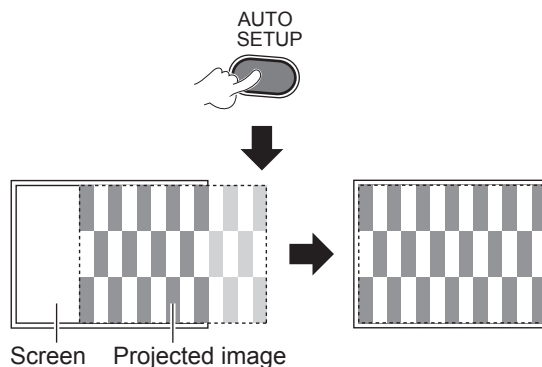

#### NOTE:

- The **SIGNAL SEARCH** will be in operation when it is set to **ON**. (⇒ page 37)
- If the dot clock frequency is higher than 162 MHz, **DOT CLOCK** and **CLOCK PHASE** can not be adjusted automatically. (⇒ page 32, 33)
- If the projected signal or image is too dark or blurred around the edge, **AUTO SETUP** may stop the process before completing the adjustment or adjust abnormally. Project a much clearer or lighter image and try again.

## Remote control operation (continued)

### RESET TO FACTORY DEFAULT SETTINGS

You can reset most of the customized settings to the factory default settings.

DEFAULT



For details, see “Reset to factory default settings”.  
(⇒ page 28)

### CONTROL SPEAKER VOLUME

You can control the volume of the built-in speakers and output audio sound.



+ : increases the volume  
- : decreases the volume

### PROJECT AN IMAGE USING INDEX-WINDOW

You can split a projected image into 2 windows using **INDEX-WINDOW**. One frozen image is stored in memory and displayed on the left side of the screen. Projection continues for the other image on the right side.

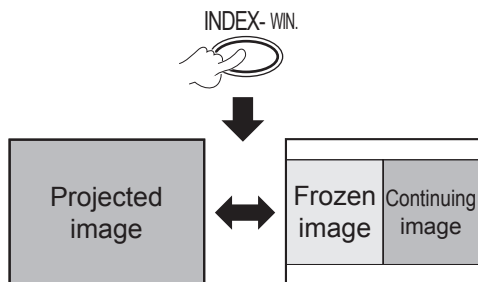

Press **[RETURN]** to escape.

### INDEX-WINDOW display

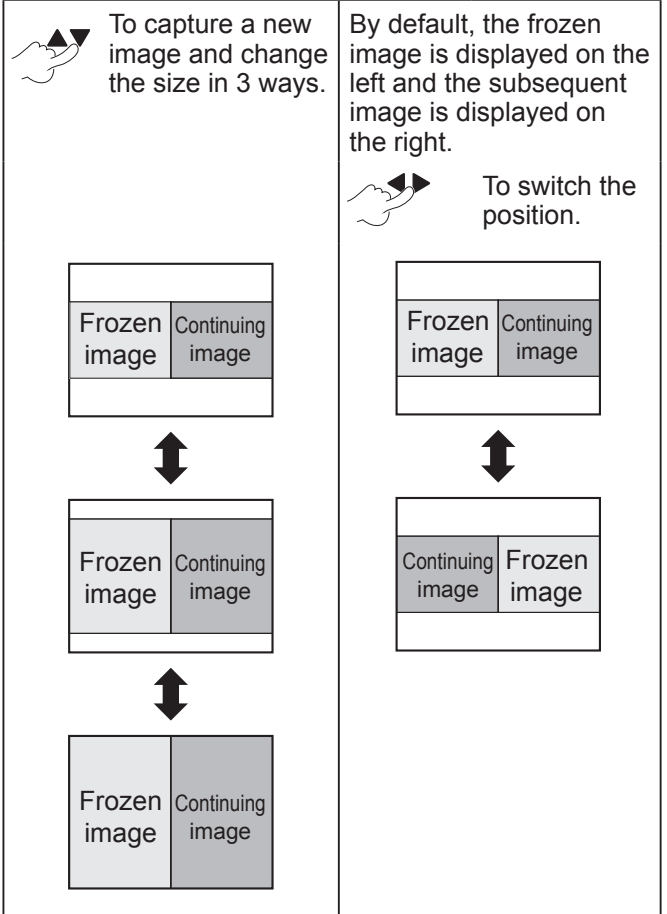

#### NOTE:

- The aspect ratio of the image is changed and becomes vertically elongated.
- If you change the window size, the aspect ratio of the image is changed. (⇒ page 33)
- While in **INDEX-WINDOW** mode, press **[ENTER]** to capture a new image and the frozen image's window will be updated.
- When capturing a quick moving picture, repeat several times to get a stable picture.

## Remote control operation (continued)

### ENLARGE THE IMAGE

You can enlarge the projected image to the center position by emphasizing within the range of 1× to 2×.

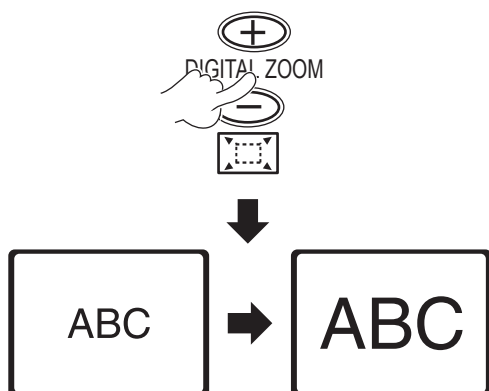

Press [RETURN] or [MENU] to escape.

### [DIGITAL ZOOM] button operation

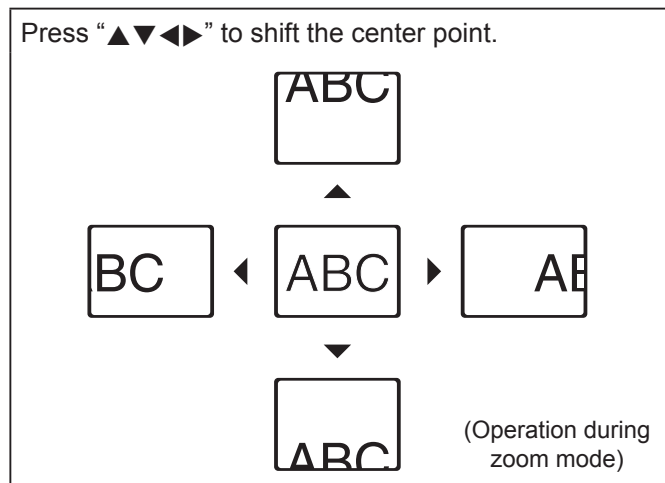
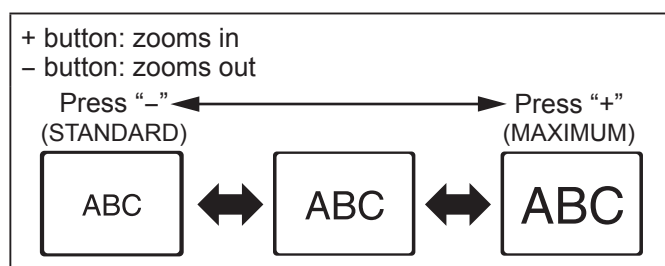

### NOTE:

- When the **COMPUTER** signal is input, if **FRAME LOCK** in the **POSITION** menu is **OFF**,  
→ enlargement range is 1× to 3×.
- When the **COMPUTER** signal is input, if **FRAME LOCK** in the **POSITION** menu is **ON**,  
→ enlargement range is 1× to 2×.
- When another signal is input, the enlargement range is from 1× to 2× by 0.1.
- **DIGITAL ZOOM** mode is canceled when the input signal is changed.
- During **DIGITAL ZOOM** mode, [AUTO SETUP], [FREEZE], [DEFAULT], [INDEX-WINDOW] and [FUNCTION] (except when **AV MUTE** is assigned) buttons are not available.
- The image is distorted momentarily when the image is zoomed.

### USE AN ASSIGNED FUNCTION

You can select a useful function from the list and assign it to [FUNCTION] button as a shortcut.

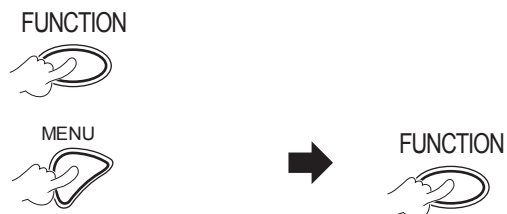

To display the on-screen menu (main menu, sub-menu or detailed menu).

For the menu operation, see “OPERATE THE MENU”. (⇒ page 28)

Press and hold for at least 3 seconds.

### When not using the [FUNCTION] button

- 1 Select **DISABLE** in **FUNCTION BUTTON** (**PROJECTOR SETUP** menu).
- 2 Press [ENTER].
- 3 Select **OK**.
- 4 Press [ENTER].

### NOTE:

- For details, see **FUNCTION BUTTON** in **PROJECTOR SETUP** menu. (⇒ page 40)

# Menu operation

## OPERATE THE MENU

Depending on the selected input signals, some items and functions may not be adjusted or available. Some can be adjusted without any signals.

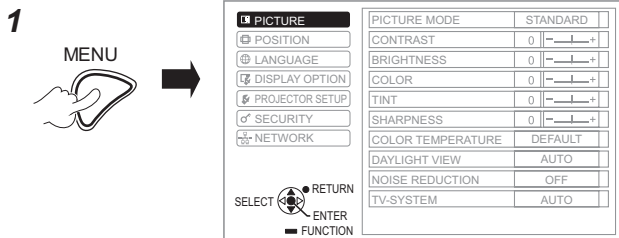

2 Select the main menu item.

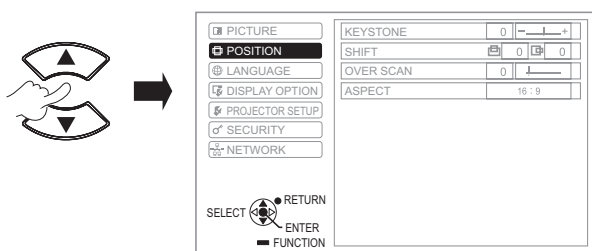

3 Select the sub-menu item.

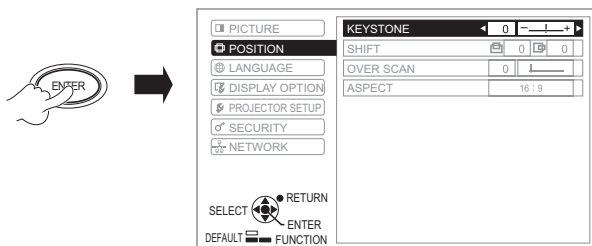

Press ▲▼ buttons to scroll to the required sub-menu item and press ◀▶ buttons or the ENTER button to adjust.

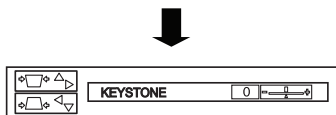

The selected menu is called up while other menu item disappears from the screen.

### NOTE:

- Press [MENU] or [RETURN] to return to the previous menu. Press repeatedly to exit from the menu mode and return to the projection.
- Called up item will disappear after 5 seconds without any operation and return to the menu mode.
- For the sub-menu items, see "SUB MENU" in the ON-SCREEN MENU (⇒ page 29).

## Reset to factory default settings

**DEFAULT** During sub-menu screen display:  
The items of the sub-menu currently displayed are reset to the factory default settings.

During called up item screen display:  
Only the item adjusted currently is reset to the factory default setting.

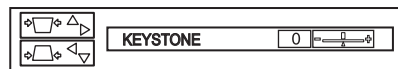

### NOTE:

- You cannot reset all the settings at one time to the factory default settings.
- For resetting all the settings, see INITIALIZE ALL (PROJECTOR SETUP menu). (⇒ page 41)
- Not all menu items can be reset by pressing [DEFAULT]. Adjust each menu item manually.

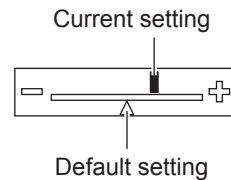

## ON-SCREEN MENU

You can access other functions from operating this menu by referring to "OPERATE THE MENU". (⇒ see left)

The **ON-SCREEN MENU** displayed consists of the main menu and sub-menu.

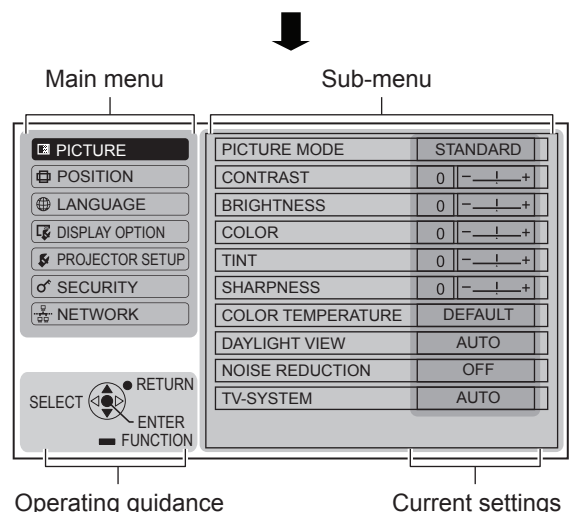

## Menu operation (continued)

### MAIN MENU

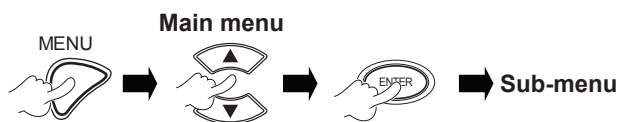

	PICTURE
	POSITION
	LANGUAGE
	DISPLAY OPTION
	PROJECTOR SETUP
	SECURITY
	NETWORK

### SUB MENU

Select the required sub-menu item and press **ENTER** to display the detailed menu.

#### PICTURE menu

S-VIDEO/VIDEO/RGB (Moving image)\*1/YP<sub>B</sub>P<sub>R</sub> signal is input.

Sub-menu item	Default	Page
PICTURE MODE	STANDARD	30
CONTRAST	0	30
BRIGHTNESS	0	30
COLOR	0	31
TINT	0	31
SHARPNESS	0	31
COLOR TEMPERATURE	DEFAULT	31
DAYLIGHT VIEW	AUTO	31
NOISE REDUCTION*2	OFF	31
TV-SYSTEM*2	AUTO	31
RGB/YP <sub>B</sub> P <sub>R</sub> *3	AUTO	32

\*1 RGB moving images can be projected only when the following signals:

480i, 576i, 480p, 576p, 1 080/60i, 1 080/60p,  
1 080/50i, 1 080/50p, 720/60p, 720/50p

\*2 Input signal is S-VIDEO/VIDEO.

\*3 Input signal is RGB/YP<sub>B</sub>P<sub>R</sub>.

RGB (Still image) is input.

Sub-menu item	Default	Page
PICTURE MODE	DYNAMIC	30
CONTRAST	0	30
BRIGHTNESS	0	30
SHARPNESS	0	31
WHITE BALANCE RED*1	0	31
WHITE BALANCE GREEN*1	0	31
WHITE BALANCE BLUE*1	0	31
COLOR TEMPERATURE	DEFAULT	31
DAYLIGHT VIEW	AUTO	31
RGB/YP <sub>B</sub> P <sub>R</sub> *2	AUTO	32

\*1 Input signal is RGB.

\*2 Input signal is RGB (VGA60).

#### NOTE:

- The factory default values vary depending on the **PICTURE MODE** setting.

#### POSITION menu

Sub-menu item	Default	Page
REALTIME KEYSTONE	ON	32
KEYSTONE	0	32
SHIFT*1	0	32
DOT CLOCK*1	0	32
CLOCK PHASE*1	0	33
OVER SCAN*1	0	33
ASPECT*1	16:9	33
FRAME LOCK*1	OFF	34

\*1 The setting is activated or deactivated depending on the input signal and the specific setting.

#### LANGUAGE menu

For details, see "LANGUAGE MENU". (⇒page 35)

#### DISPLAY OPTION menu

Sub-menu item	Default	Page
ON-SCREEN DISPLAY	—	35
STARTUP LOGO	ON	36
AUTO SETUP	AUTO	37
SIGNAL SEARCH	ON	37
BACK COLOR	BLUE	37
WIDE MODE*1	AUTO	38
SXGA MODE*1	SXGA	38
OTHER FUNCTIONS	—	38

\*1 The setting is activated or deactivated depending on the input signal and the specific setting.

## Menu operation (continued)

### PROJECTOR SETUP menu

Sub-menu item	Default	Page
STATUS	—	38
NO SIGNAL SHUT-OFF	DISABLE	39
INITIAL START UP	LAST MEMORY	39
INSTALLATION	FRONT/DESK	39
HIGH ALTITUDE MODE	OFF	39
STANDBY MODE	ECO	39
LAMP POWER	NORMAL	39
LAMP RUNTIME	—	40
EMULATE	DEFAULT	40
FUNCTION BUTTON	STATUS	40
AUDIO SETTING	—	40
TEST PATTERN	—	41
INITIALIZE ALL	—	41

### SECURITY menu

Sub-menu item	Default	Page
PASSWORD	OFF	42
PASSWORD CHANGE	—	42
TEXT DISPLAY	OFF	42
TEXT CHANGE	—	42
MENU LOCK	OFF	43
MENU LOCK PASSWORD	—	43
CONTROL DEVICE SETUP	—	44

### NETWORK menu

For details of items, see “Network Operation Manual”.

Sub-menu item	Default
WIRED LAN	—
NAME CHANGE	—
NETWORK CONTROL	ON
STATUS	—
INITIALIZE	—

#### NOTE:

- Sub-menu items and the factory default settings vary according to the selected input signal.

### PICTURE MENU

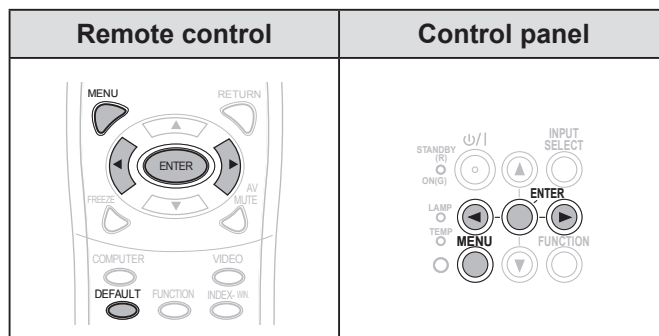

Set the selected item with [◀▶].

#### PICTURE MODE

You can optimize the projected image depending on the projection's environment.

Change setting   Change setting

<b>STANDARD</b>	Setting for general image
<b>DYNAMIC</b>	Setting for brightness and sharpness
<b>BLACKBOARD</b>	Setting for when projecting on a blackboard
<b>WHITE BOARD</b>	Setting for when projecting on a white board
<b>NATURAL</b>	Reproducing the original color of the image

#### NOTE:

- It may take a while until the selected mode is stabilised.

#### CONTRAST

You can adjust the contrast of the projected image.

Lower   Higher

#### BRIGHTNESS

You can adjust the brightness of the projected image.

Darker   Brighter

## Menu operation (continued)

### COLOR

You can adjust the color saturation of the projected image. (For **S-VIDEO/VIDEO/RGB** (Moving image)/**YPbPr** input signal only)



### TINT

You can adjust the skin tone of the projected image. (For **S-VIDEO/VIDEO/RGB** (Moving image)/**YPbPr** input signal only)



### SHARPNESS

You can adjust the sharpness of the projected image.



#### NOTE:

- The adjustable range depends on the input signal.

### WHITE BALANCE

You can adjust the white balance in 3-color temperature. (For **RGB** (Still image) input signal only)



Advanced menu item	Default
<b>WHITE BALANCE RED</b>	<b>0</b>
<b>WHITE BALANCE GREEN</b>	<b>0</b>
<b>WHITE BALANCE BLUE</b>	<b>0</b>

### COLOR TEMPERATURE

You can adjust the white balance of the projected image.



<b>DEFAULT</b>	Balanced white
<b>HIGH</b>	More bluish
<b>LOW</b>	More reddish

### DAYLIGHT VIEW

You can keep the projected image bright and vivid even in well-lit rooms where the ambient light sources cannot be controlled.



<b>AUTO</b>	Automatic adjustment
<b>ON</b>	Active
<b>OFF</b>	Deactive

#### NOTE:

- Do not cover the Ambient Luminance Sensor(ALS) of the projector, otherwise the **AUTO** mode may not function properly.
- AUTO** is not available when **INSTALLATION** in **PROJECTOR SETUP** menu is set to **REAR/DESK** or **REAR/CEILING**.

### NOISE REDUCTION

You can switch the automatic noise reduction system on/off. (For **S-VIDEO/VIDEO** input signal only)



<b>OFF</b>	No noise reduction
<b>ON</b>	Automatic noise reduction

#### NOTE:

- If **NOISE REDUCTION** is set active when the selected input signal has less noise, the image may look different from the true image. If so, set to **OFF**.

### TV-SYSTEM

Switch the setting manually to match the video data. (For **S-VIDEO/VIDEO** input signal only)

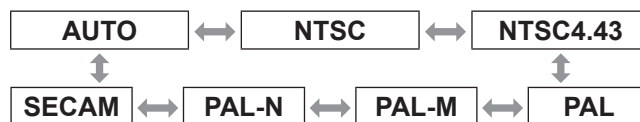

#### NOTE:

- AUTO** mode is selected by default.
- When the projector is not working properly in **AUTO** mode, change the setting according to each TV system type.
- AUTO** setting will automatically select the compatible signal from **NTSC/NTSC 4.43/PAL/PAL60/PAL-M/PAL-N/SECAM**.

## Menu operation (continued)

### RGB/YPbPr

(For RGB/YPbPr input signal only)  
Select the signals to be input to the **COMPUTER 1 IN** and **COMPUTER 2 IN** terminals.

Change setting  Change setting

<b>AUTO</b>	Automatic adjustment
<b>RGB</b>	For RGB signals
<b>YPbPr</b>	For YPbPr signals

#### NOTE:

- **AUTO** mode is selected by default.
- Select **RGB** or **YPbPr** according to the input signal if the image is not normally projected during **AUTO** mode. The function only becomes effective when certain signals are input:  
(VGA60, 480i, 576i, 480p, 576p, 1 080/60i, 1 080/60p, 1 080/50i, 1 080/50p, 720/60p, 720/50p)

## POSITION MENU

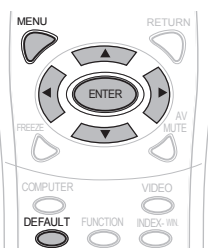
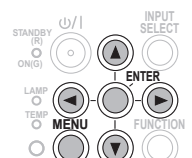
Remote control	Control panel
	

Set the selected item with [**▲▼◀▶**].

### REALTIME KEYSTONE

If the projector is aligned non-perpendicularly to the screen, or if the projection screen has an angled surface; the keystone will be automatically corrected.

Change setting  Change setting





<b>OFF</b>	Deactive
<b>ON</b>	Active

#### NOTE:

- If the detected tilt of the main unit is  $\pm 5\%$ , even if you set **ON**, the distortion will not be corrected automatically. Because the priority is not to correct the distortion, but to avoid the image quality deteriorated by correcting.
- If you need to correct the keystone, you can correct the distortion manually by adjusting the **KEYSTONE**.

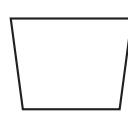
### KEYSTONE

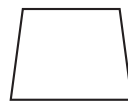
If you need to correct the angle of the projection even when the **REALTIME KEYSTONE** is activated, you can correct the keystone manually.

Image	Operation
	
	

#### NOTE:

- You can correct the distortion  $\pm 30^\circ$  from the plane.
- For a better image quality, install the projector to minimize distortion.
- The result of the keystone correction will affect the aspect ratio and the size of the image.
- The image is distorted momentarily when the keystone is corrected.

### SHIFT

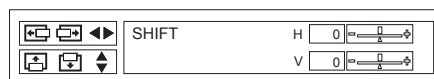

Horizontal (H): Press [**◀▶**] to move the image horizontally.

Vertical (V): Press [**▲▼**] to move the image vertically.

#### NOTE:

- This function can be adjusted by pressing the **◀▶▲▼** buttons directly.

### DOT CLOCK

If there are interference patterns on the projected image (referred as moire or noise), minimize it by pressing [**◀▶**] to adjust the clock frequency. (For **RGB** (Still image) input signal only)

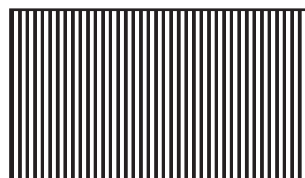

#### NOTE:

- **DOT CLOCK** needs to be adjusted before adjusting the **CLOCK PHASE**.



## Menu operation (continued)

### CLOCK PHASE

If you require further adjustment for the same reason as the **DOT CLOCK** adjustment, you can further adjust the timing of the clock. (For **RGB/YPbPr** input signal only)  
Press ◀▶ buttons to adjust.

#### NOTE:

- If the projecting signal's dot clock frequency is higher than 162 MHz, adjusting **DOT CLOCK** or **CLOCK PHASE** may not make any difference. Refer to "LIST OF COMPATIBLE SIGNALS". (⇒ page 52)

### OVER SCAN

Use this function when characters or pictures are cropped near the periphery of the projected image.  
(For **S-VIDEO/VIDEO/RGB** (Moving image)/**YPbPr** input signal only)



Setting range: 0 to +3

### ASPECT

You can manually switch to the desired aspect ratio.  
Selectable options vary according to input signal.

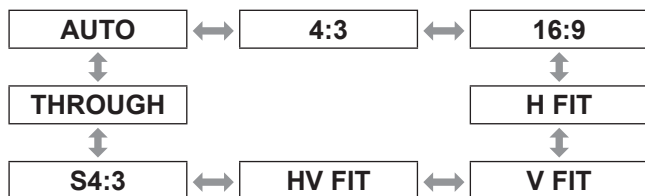

#### NOTE:

- AUTO** mode is displayed only when NTSC/480i signal is input.
- THROUGH** mode is displayed only for certain signals.
- For the wide signal\*<sup>2</sup>, the aspect ratio option cycles through 16:9 ↔ V FIT ↔ HV FIT.

#### AUTO (For NTSC/480i input signal only)

The signal which contains an identifying signal will be detected and will automatically project the image in the most optimal aspect setting.

### 4:3

Standard input signal\*<sup>1</sup> → projection is 4:3 aspect ratio.

Input signal: XGA

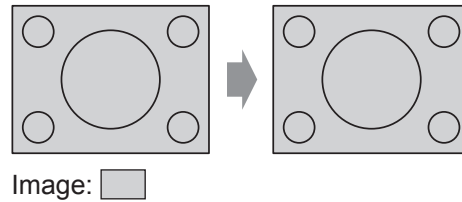

### 16:9

Standard input signal\*<sup>1</sup> → projection is 16:9 aspect ratio.

Wide input signal\*<sup>2</sup> → projection is the current aspect ratio.

Input signal: 1 080/60i

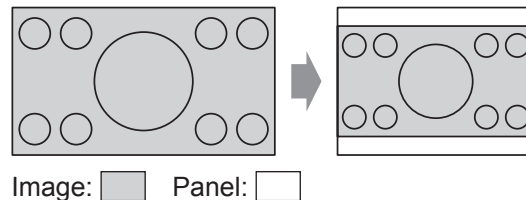

### H FIT

Standard input signal\*<sup>1</sup> → projection without changing the aspect ratio uses all the panel pixels in the horizontal direction to crop the top and bottom of the image.

Input signal: SXGA

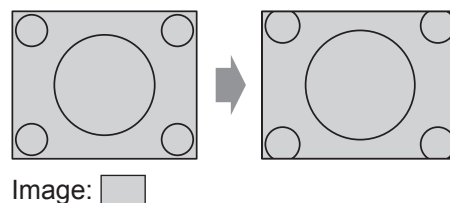

\*<sup>1</sup> A standard signal has an aspect ratio of 4:3 or 5:4.

\*<sup>2</sup> A wide signal has an aspect ratio of 16:10, 16:9 or 15:9.

## Menu operation (continued)

### V FIT

Wide input signal\*2 → projection without changing the aspect ratio uses all the panel pixels in the vertical direction to crop the right and left of the image.

Input signal: 1 080/60i

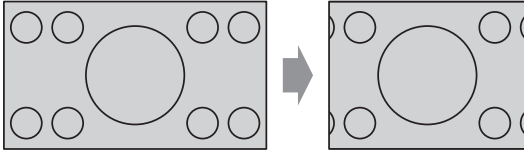

Image:

### HV FIT

The image is projected all over the panel pixels (screen). The input signal is projected at the aspect ratio of the panel screen.

Input signal: 1 080/60i

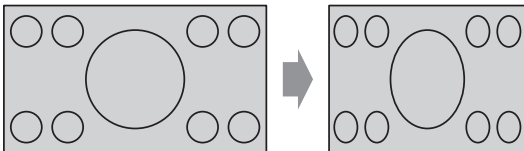

Image:

### S4:3

Standard input signal\*1 → the input signal will be sized down 75% and projected. S4:3 mode is effective when projecting 4:3 image onto a 16:9 screen.

Input signal: XGA

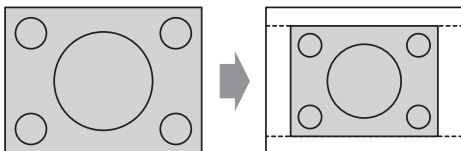

Image:  Panel:  Screen:

\*1 A standard signal has an aspect ratio of 4:3 or 5:4.

\*2 A wide signal has an aspect ratio of 16:10, 16:9 or 15:9.

### THROUGH

The image will be projected without any size adjustment.

This function can be set when the input signal is smaller than the number of the LCD panel pixels (1024 x 768).

Input signal: NTSC

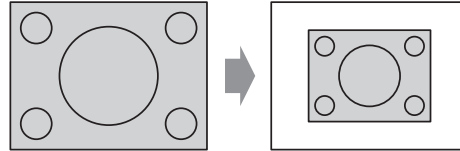

Image:  Panel:

### NOTE:

- When a 4:3 image is projected to 16:9 screen, the image may be distorted or some portions may be cropped. Select an aspect ratio (4:3) which retains the creator's intended image.
- The order of **ASPECT** types is defined not only by the input method but also by the input signals.
- If you project an enlarged or distorted copyrighted image using the **ASPECT** function for commercial use in a public place, you might infringe the copyright of the creator which is protected by the copyright law.

### FRAME LOCK

If the projected image is bad, you can activate **FRAME LOCK** for synchronization. (For **RGB** input signal only)

Change setting  Change setting

ON	Active
OFF	Deactive

## Menu operation (continued)

### LANGUAGE MENU

Select the required language.

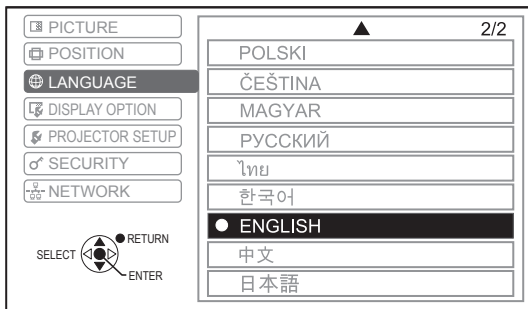
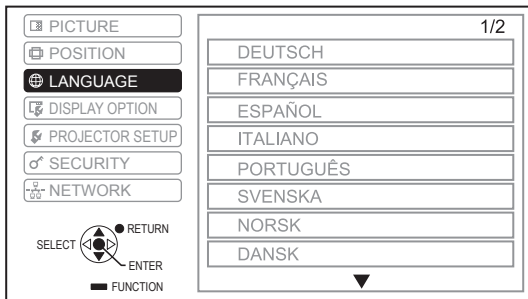
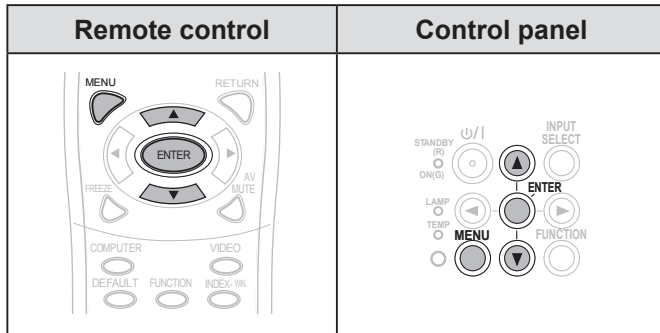

The set language is highlighted.

### DISPLAY OPTION MENU

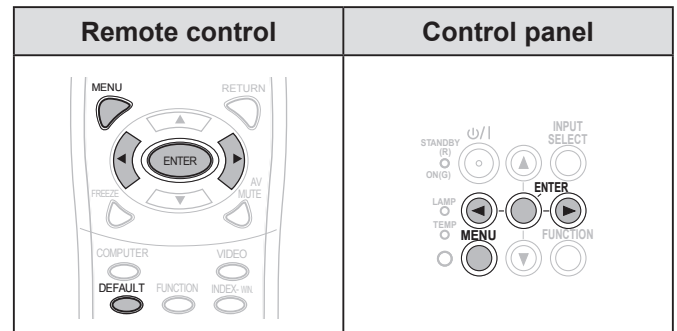

Set the selected item with [◀▶].

### ON-SCREEN DISPLAY

You can set the on-screen display.



### INPUT GUIDE

Set the display method of the input terminal name currently selected in the upper right corner of the screen.

<b>DETAILED</b>	Display the input method using graphic. The <b>INPUT GUIDE</b> will go off if there is no operation after 10 seconds.
<b>OFF</b>	Turn off the guide.
<b>SIMPLE</b>	Display the input method using text. The <b>INPUT GUIDE</b> will go off if there is no operation after 5 seconds.

## Menu operation (continued)

### Computer connection guide

You can switch the output signals from **COMPUTER1/COMPUTER2** terminal by pressing the following computer command keys.

Manufacturer	Image output selection command	Manufacturer	Image output selection command
Panasonic NEC	<b>Fn</b> + <b>F3</b>	lenovo LG SONY	<b>Fn</b> + <b>F7</b>
SAMSUNG HP	<b>Fn</b> + <b>F4</b>	DELL EPSON	<b>Fn</b> + <b>F8</b>
acer SHARP TOSHIBA	<b>Fn</b> + <b>F5</b>	FUJITSU	<b>Fn</b> + <b>F10</b>
		Apple	<b>F7</b>

#### NOTE:

- The command keys depend on the manufacturers. For detailed information, please refer to the instructions provided with the computers.
- If you want to turn off the computer connection guide, select **SIMPLE** or **OFF**.

### OSD DESIGN

You can change the background of the on-screen menu (OSD).

<b>TYPE1</b>	Semi transparent black
<b>TYPE2</b>	Solid blue
<b>TYPE3</b>	Semi transparent dark blue

### WARNING MESSAGE

You can choose to or not to display the warning messages.

<b>ON</b>	Warning messages will be displayed
<b>OFF</b>	No display

#### NOTE:

- When the **WARNING MESSAGE** is set to **OFF**, use the projector with utmost care as most of the warning messages will not be displayed.

### STARTUP LOGO

You can set the Panasonic logo, your own image or Pre-set letters to be displayed at the start of the projection.



<b>ON</b>	Display "Panasonic" logo
<b>TEXT</b>	Display the original text
<b>USER</b>	Display the image registered by the user
<b>OFF</b>	No display

#### NOTE:

- If **TEXT** is selected, the input letters are displayed at the start of the projection. You can display 2 lines of original text which contains up to 40 characters each.
- If **USER** is selected, the image transferred by the Logo Transfer Software is displayed at the start of the projection. (You can install the Logo Transfer Software from the provided CD-ROM.)
- STARTUP LOGO** will be displayed for 30 seconds.

## Menu operation (continued)

### Editing the original text

- 1 Press [◀▶] to select TEXT and then press [ENTER].
- 2 Press [▲▼] to select the desired line and then press [ENTER].  
You can input and edit the text for the first line in TEXT1 and the text for the second line in TEXT2.

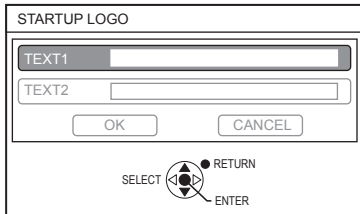

- 3 Press [▲▼◀▶] to select the desired character and then press [ENTER].  
To delete all the input characters, move the cursor to **ALL DELETE** and then press [ENTER].  
To delete a character, press [DEFAULT] or move the cursor to select the character then press [DEFAULT].

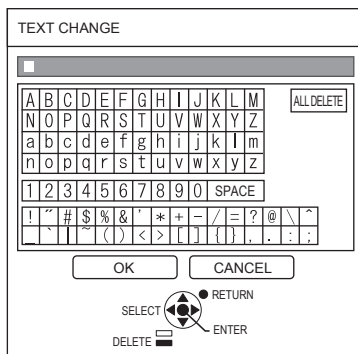

- 4 Select OK and then press [ENTER] to set the input text in the box.
- 5 Select OK again and then press [ENTER]. Select CANCEL or press [MENU/RETURN] to return to the previous menu without any setting.

### AUTO SETUP

AUTO mode is selected by default. If you do not need to perform automatic correction, select "BUTTON".



<b>AUTO</b>	When the projector detects <b>COMPUTER</b> signal, <b>SHIFT</b> , <b>DOT CLOCK</b> and <b>CLOCK PHASE</b> in the <b>POSITION</b> menu is automatically set.
<b>BUTTON</b>	Only when [AUTO SETUP] is pressed, <b>SHIFT</b> , <b>DOT CLOCK</b> and <b>CLOCK PHASE</b> in <b>POSITION</b> menu will be automatically set for <b>COMPUTER</b> signals. (⇒ page 25)

### SIGNAL SEARCH

You can turn off the auto signal detection.



<b>ON</b>	Detects the input signal from the terminals and projects the image
<b>OFF</b>	Deactive

#### NOTE:

- **SIGNAL SEARCH** is not available during any input signal projection.

### BACK COLOR

You can choose **BLUE** or **BLACK** screen for the projector when it is idle.



<b>BLUE</b>	Display blue screen
<b>BLACK</b>	Display black screen

## Menu operation (continued)

### WIDE MODE

Set this mode when projecting wide signals (16:9, 16:10, 15:9).

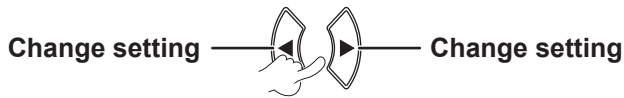

<b>AUTO</b>	Automatic setting
<b>OFF</b>	For 4:3 signals
<b>ON</b>	For WIDE signals

### SXGA MODE

Set this mode when an **SXGA** signal is input and the projected image is trimmed.



<b>SXGA</b>	For normal projection
<b>SXGA+</b>	For projection when image is cropped

### OTHER FUNCTIONS

You can perform some of the remote control button operations from the sub-menu.

#### AUTO SETUP

For details, see "SET UP THE IMAGE POSITION AUTOMATICALLY". (⇒ page 25)

#### FREEZE

You can capture the projected image as a still picture. While the image is frozen, the audio sound through the projector will stop.

Press **[RETURN]** to escape.

The image is distorted momentarily when the projection is stopped and restarted.

#### AV MUTE

You can temporarily stop projection and audio sound when the projector is left idle.



Press **[MENU]** to escape.

### INDEX-WINDOW

For details, see "INDEX-WINDOW display". (⇒ page 26)

### DIGITAL ZOOM



 button: zoom in  
 button: zoom out

Press **[ENTER]** to select the enlargement. Press **[MENU]** to escape.

The image is distorted momentarily when the image is zoomed.

## PROJECTOR SETUP MENU

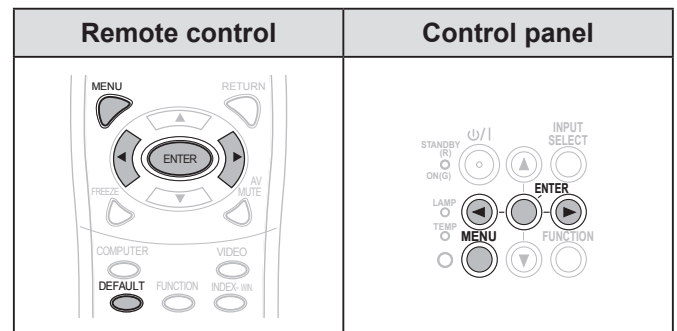

Set the selected item with **[◀▶]**.

### STATUS

You can check the projector's status.

#### SIGNAL

NAME → Name of input signal

FREQUENCY → Scanning frequency of input signal

#### RUNTIME

PROJECTOR → Display the projector's current usage time

LAMP → Display the lamp's current usage time

## Menu operation (continued)

### NO SIGNAL SHUT-OFF

If no image signal is input for the time set using the timer, the projector will automatically enter into standby mode.

Change setting  Change setting

<b>DISABLE</b>	<b>NO SIGNAL SHUT-OFF</b> is disabled
<b>15 – 60 MIN.</b>	Timer can be set at a 5-minute intervals

### INITIAL START UP

You can set the starting method when the power plug is connected to wall outlet.

Change setting  Change setting

<b>LAST MEMORY</b>	Projector starts from the last image before the power plug was disconnected
<b>STANDBY</b>	Projector starts in the standby mode
<b>ON</b>	Projector starts immediately

### INSTALLATION

When installing the projector, select the projection method according to the projector's position.  
(⇒ page 17)

Change setting  Change setting

### HIGH ALTITUDE MODE

If you use the projector at high elevation, the **HIGH ALTITUDE MODE** setting need to be **ON** to set the fan speed to high.

Change setting  Change setting

<b>OFF</b>	Use in normal environment (below 1 400 m (4 593 ft) above sea level)
<b>ON</b>	Use at high altitude (at 1 400 m – 2 700 m (4 593 - 8 858 ft) above sea level)

#### NOTE:

- The loudness of fan noise depends on the **HIGH ALTITUDE MODE** setting.

### STANDBY MODE

You can change the standby mode setting.

Change setting  Change setting

<b>ECO</b>	The standby power is reduced to 0.4 W to save power
<b>NORMAL</b>	The power of the projector can be turned <b>ON</b> and the audio output can be set active by controlling the computer connected via wired LAN in standby mode

### LAMP POWER

You can adjust the power of the lamp to save electricity and reduce the noise.

Change setting  Change setting

<b>NORMAL</b>	When higher luminance is required
<b>ECO</b>	When lower luminance is sufficient

#### NOTE:

- This function is disabled when no input signal is detected.
- ECO** setting is recommended when higher luminance is not required such as in a small room.

## Menu operation (continued)

### LAMP RUNTIME

You can check how long the lamp has been used.

#### NOTE:

- **LAMP RUNTIME** is important for lamp replacement timing. See "REPLACE THE LAMP UNIT". (⇒ page 47)
- Check the lamp unit replacement time. (⇒ page 47)
- If the lamp runtime has reached 3 800 hours, the red (time indicator) and gray marks appear alternately to notify you of the lamp replacement time.
- The lamp life varies depending on the usage condition (number of power-on times, etc.).

### EMULATE

When the projector is controlled by a computer through serial input terminal, you can change the setting to use the former projector control commands.

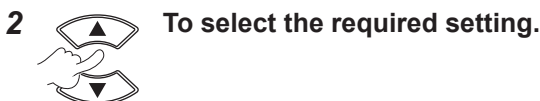

• DEFAULT	LB3 LB2 LB1 ST10 LB75 Series LB78 Series LB80 Series LW80NT LB90 Series
D3500	D3500
D4000	D4000
D/W5K series	D5500 Series DW5000 Series D5600 Series DW5100 Series D5700 Series
D/W/Z6K series	D5000 Series D6000 Series DW6300 Series DZ6700 Series DZ6710 Series
L730	L520 Series L720 Series L730 Series
L780	L750 Series L780 Series
L735	L735 Series
L785	L785 Series
F/W series	F100 Series FW100 Series F200 Series F300 Series FW300 Series

#### NOTE:

- Some commands are not available. For details, please contact your dealer.

### FUNCTION BUTTON

You can select a useful function from the list and assign it to **[FUNCTION]** button as a short-cut.



To display the on-screen menu (main menu, sub-menu or detailed menu).

Press and hold for at least 3 seconds.

For the menu operation, see "OPERATE THE MENU".

(⇒ page 28)

When not using the **[FUNCTION]** button (⇒ page 27)

#### NOTE:

- The text and button color will change once the setting has completed.

### AUDIO SETTING

You can perform detailed setting for Audio.

#### VOLUME

You can adjust the volume of the the built-in speakers and audio output sound.



#### BALANCE

You can adjust to listen to the sound played equally from both right and left external stereo speakers, or adjust the balance so that more sound plays from either the left or right side.





## Menu operation (continued)

### IN STANDBY MODE

You can turn **ON** or **OFF** the audio output in standby mode.

Change setting  Change setting

OFF	Deactive
ON	Active

#### NOTE:

- When **STANDBY MODE** is set to **ECO**, the audio output cannot be activated in the standby mode, even if **ON** is selected.

### AUDIO IN SELECT

You can select the **AUDIO IN 1** or **AUDIO IN 2** terminal to connect the audio output of the devices connected to **COMPUTER 1 IN** or **COMPUTER 2 IN**.

Change setting  Change setting

AUDIO IN SELECT	
COMPUTER1 IN	Select <b>AUDIO IN 1</b> or <b>AUDIO IN 2</b> terminal
COMPUTER2 IN	Select <b>AUDIO IN 1</b> or <b>AUDIO IN 2</b> terminal

### TEST PATTERN

You can use the 7 different test patterns to adjust the focus of the image.

 To display the test pattern.

Change pattern  Change pattern

Press **[MENU]** or **[RETURN]** to return to the **PROJECTOR SETUP** menu, or press repeatedly to escape the menu mode.

#### NOTE:

- The initial screen is an all white pattern. Only when **TEST PATTERN** is assigned to the **[FUNCTION]** button, the lattice pattern will be displayed as the initial screen.

### INITIALIZE ALL

You can reset all of the customized settings in **MENU** to the factory default.

- If the **[ENTER]** is pressed in the **INITIALIZE ALL** menu, "**INITIALIZE ALL**" will be displayed. Select **OK** and press **[ENTER]**, "**NOW INITIALIZING...**" is displayed followed by "**POWER OFF**" display. Select **OK** and turn the power off according to the instruction. (All other buttons are deactivated.)
- The **LANGUAGE** and **INITIAL SETTING** menu screen will be displayed when the power is connected. (⇒ page 12)

#### NOTE:

- The usage time of the projector, lamp runtime and the **NETWORK** settings will not be initialized.
- When **PASSWORD** in **SECURITY** menu is activated, ensure to enter the correct password when initializing.
- After **INITIALIZE ALL** operation is completed, the password is reset to the factory default setting and **PASSWORD** setting is turned **OFF**.

## Menu operation (continued)

### SECURITY MENU

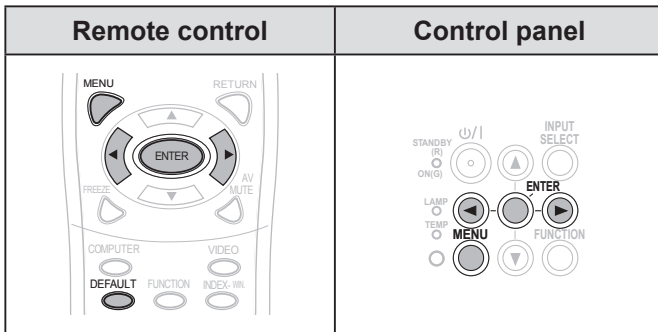

Set the selected item with [◀▶].

When you use **SECURITY** menu for the first time, you will be asked to perform the password operation. Input the *initial password* by pressing [▲▶▼◀▶▶▼◀] in this order and then press [ENTER].

#### NOTE:

- If you have changed the password, input the new password and press [ENTER].

### PASSWORD

You can activate the security system and the password operation will be asked to perform when projection mode starts.

Change setting Change setting

OFF	Deactive
ON	Active

#### NOTE:

- **PASSWORD** is set to **OFF** by default and when initialized.
- Change your password regularly. Do not use a simple password that is easy to decode.
- Unless you perform the correct password operation, all of the control buttons will be disabled except the [POWER] button.

### PASSWORD CHANGE

You can change the password.

- To change the password.  
(Up to 8 button operations can be set.)
- 
- Input the password again and press the button.

#### NOTE:

- The entered password operations will appear as asterisks in the box.
- If the password input second does not match with the password input first, an error message is displayed. In this case, input the correct password again.

### TEXT DISPLAY

You can set your original text to display regularly at the bottom of the projected image during projection.

Change setting Change setting

OFF	Deactive
ON	Active

### TEXT CHANGE

You can enter your original text to be displayed when **TEXT DISPLAY** is turned **ON**.

- 

#### To select the characters

(You can input up to 22 characters.)

To delete all the entered characters, move the cursor to **ALL DELETE** and press [ENTER].

## Menu operation (continued)

To delete a character, press **[DEFAULT]** or move the cursor to the required character then press **[DEFAULT]**.

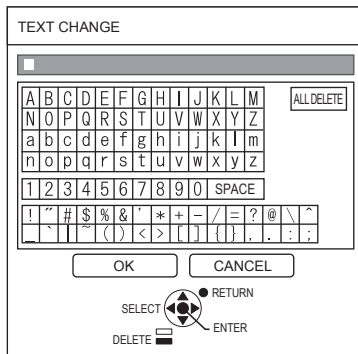

**To select OK**

Select **CANCEL** or press **[MENU/RETURN]** to return to the previous menu without setting.

## MENU LOCK

Press **[MENU]** to display the menu. You can lock or unlock the menu operation.

Change setting  Change setting

OFF	Unlock the menu operation
ON	Lock the menu operation

### NOTE:

- Once **MENU LOCK** is set to **ON**, you cannot use the **[MENU]** button unless you input the correct password.
- The **MENU LOCK** is set to **OFF** by default and when initialized.

## MENU LOCK PASSWORD

You can set a **MENU LOCK PASSWORD**.



**To select the characters**

(You can input up to 16 characters.)

To delete all the entered characters, move the cursor to **ALL DELETE** and press **[ENTER]**.

To delete a character, press **[DEFAULT]** or move the cursor to the required character then press **[DEFAULT]**.

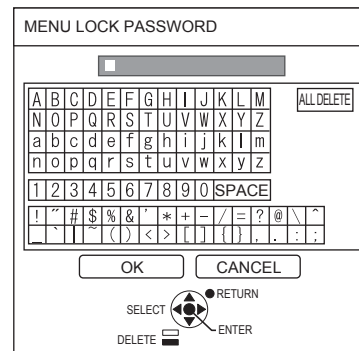

**To select OK**

Select **CANCEL** or press **[MENU/RETURN]** to return to the previous menu without setting.

### NOTE:

- When using the projector for the first time or after **INITIALIZE ALL** operation is activated, the initial password is set to **AAAA**.
- Change your password regularly. Do not use a simple password that is easy to decode.
- To reset the password to the initial password, see **MENU LOCK PASSWORD**. (⇒ page 54)

## Menu operation (continued)

### CONTROL DEVICE SETUP

You can enable/disable the button operations of the control panel and remote control.

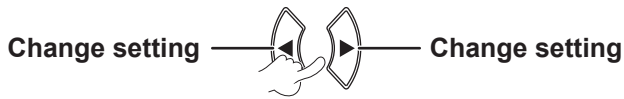

#### CONTROL PANEL

<b>ENABLE</b>	Enable the button operations
<b>DISABLE</b>	Disable the button operations

#### REMOTE CONTROLLER

<b>ENABLE</b>	Enable the button operations
<b>DISABLE</b>	Disable the button operations

#### NOTE:

- If **DISABLE** is selected and **[ENTER]** is pressed, the confirmation screen appears. Select **OK** and press **[ENTER]**.
- If any button is pressed after **CONTROL PANEL** is set to **DISABLE**, the password screen appears. Input the password which is set in the **SECURITY** menu. (If no operation is done, the password screen disappears in 10 seconds.)
- If you set both **CONTROL PANEL** and **REMOTE CONTROLLER** to **DISABLE**, all buttons' operations of the control panel and remote control are disabled and you cannot turn off the power.

#### How to clear **DISABLE**:

During the standby mode or projection, press and hold **[ENTER]** and **[MENU]** for at least 2 seconds, and **CONTROL PANEL** is set to **ENABLE**.

Change the setting of **REMOTE CONTROLLER** with the control panel.

### NETWORK MENU

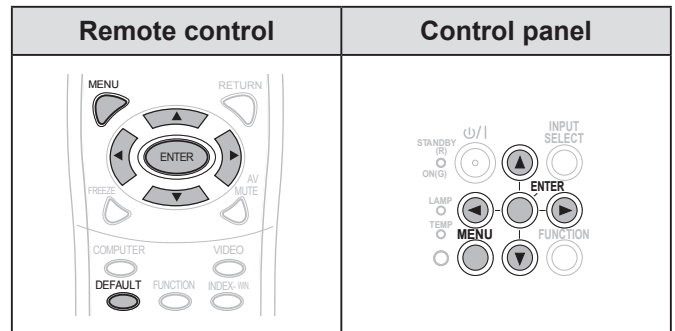

Set the selected item with **[◀▶]**.

#### NOTE:

- These items are set for network connection with a computer. For details of the PJ Link and network, see "Network Operation Manual".

#### WIRED LAN

You can set up a wired LAN.

#### NAME CHANGE

You can change the name of the projector.

#### NETWORK CONTROL

When controlling the projector with a computer on the network, you must turn this function **ON**.

#### STATUS

You can display the status of the network setting.

#### INITIALIZE

You can reset the settings of the network to the factory default settings.

#### NOTE:

- If **PASSWORD** (**SECURITY** menu) is activated, when the network setting is initialized, you will be required to input the password.

## LAMP and TEMP indicators

The **LAMP** and/or **TEMP** indicators will light up to indicate that the projector has some problems.

### NOTE:

- Make sure to turn off the power (see “TURN THE PROJECTOR OFF” on page 23) and confirm the power supply status with the POWER indicator. (⇒ page 21)

**TEMP** indicator    **LAMP** indicator

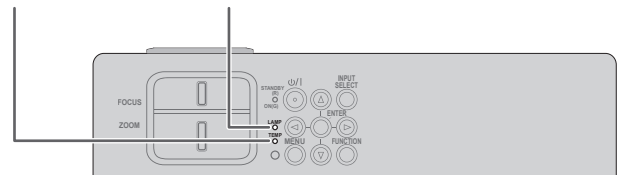

Manage the problem as follows:

### LAMP INDICATOR

Indicator	• Illuminating red	• Flashing red		
<b>Problem</b>	<b>LAMP RUNTIME</b> has reached 3 800 hours.	<b>LAMP</b> circuit failure, abnormal function or the lamp unit is damaged.		
<b>Cause</b>	Lamp unit will run out soon and needs to be replaced.	The projector is turned on again too soon.	<b>LAMP</b> circuit failure, abnormal function.	Lamp unit is damaged.
<b>Remedy</b>	See “REPLACE THE LAMP UNIT”. (⇒ page 47)	Let the lamp unit cool down and turn on the projector after 90 seconds.	Turn the projector off (⇒ page 23) and contact an Authorized Service Center.	See “REPLACE THE LAMP UNIT”. (⇒ page 47)

### NOTE:

- If the **LAMP** indicator still lights or flashes after the above remedy, contact an Authorized Service Center.

### TEMP INDICATOR

Indicator	• Illuminating red while projecting and the alert will be displayed. • Flashing red and power is turned off.			
<b>Problem</b>	The temperature inside and/or outside the projector is abnormally high. • The projection may become darker than usual. • The internal fan’s operational noise may be louder than usual.			
<b>Cause</b>	The air outlet port and air intake ports are covered.	The room temperature is too high.	The filter is excessively dirty and the ventilation is poor.	The projector is located at 1 400 - 2 700 m (4 593 - 8 858 ft).
<b>Remedy</b>	Remove object(s) from the air outlet port and air intake ports or clear around the projector.	Reinstall the projector in temperature controlled place. (⇒ page 56)	Clean the filter in a proper method. (⇒ page 46)	Turn on the projector* <sup>1</sup> and set the <b>HIGH ALTITUDE MODE</b> to <b>ON</b> . (⇒ page 39)

\*<sup>1</sup> The projector will operate for 2 minutes with **OFF** set at high elevation.

### NOTE:

- Perform the above remedy; disconnect the power plug, and then supply the power again. If the **TEMP** indicator still lights or flashes after the above remedy, contact an Authorized Service Center.
- If temperature in the projector rises, the fan speed increases and the sound becomes louder.

## Care and replacement

### Preparations

Before cleaning, be sure to turn off the power and disconnect the power plug from the wall outlet.  
(⇒ page 20, 23)

## CLEANING THE PROJECTOR

### Cabinet

Wipe off dirt and dust gently with a soft cloth.

- If it is difficult to remove the dirt, wipe the projector with a damp cloth. Dry off the projector with dry cloth.
- Do not use petroleum benzine, thinner, any alcoholic solvent, kitchen detergents or chemical cloths. Failure to observe these may result in altered or damaged surfaces of the projector.

### Projector lens

Make sure no dirt or dust remains on the surface of the projector lens glass. It will be enlarged and projected onto the screen.

Wipe off dirt and dust gently with a lint-free cloth. Do not wipe the projector lens with a cloth which has collected dust.

#### NOTE:

- Clean the projector lens with special care.

### Air filter

If the air filter is excessively dirty, the internal temperature of the projector increases, the **TEMP** indicator lights, and the power is turned off.

If the power is turned off, the **TEMP** indicator flashes.

Clean the air filter regularly every 100 hours of usage.

#### 1 Remove the air filter.

While pressing the tab of the air filter, pull the air filter open slowly.

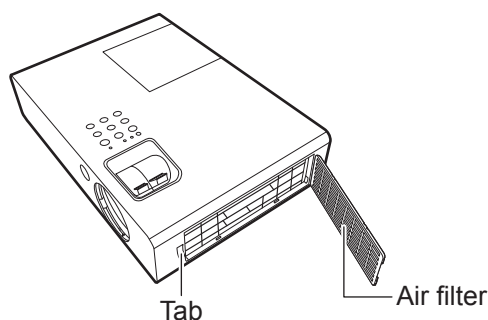

#### 2 Clean the air filter.

Vacuum dirt and dust from the air filter.

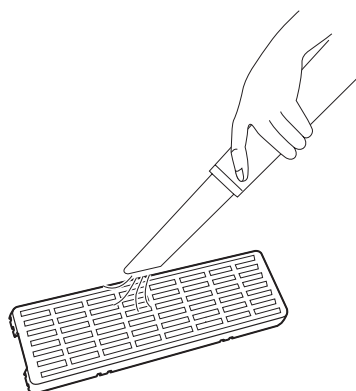

#### 3 Install the air filter.

Install in the reverse order to 1).

#### NOTE:

- Do not use the projector without attaching the air filter. Otherwise, it will suck in dirt and dust which can cause malfunction.
- The TEMP indicator may flash because of clogging within 100 hours, depending on the using environment. In that case, clean the air filter at shorter intervals.

## Care and Replacement (continued)

### REPLACE THE LAMP UNIT

#### Air filter

The air filter should be replaced when cleaning is ineffective and when replacing the lamp unit. A replacement air filter is provided with a replacement lamp unit (ET-LAB2). Contact an Authorized Service Center for the air filter (TXFKN01VKN5).

#### Lamp unit

The lamp unit, ET-LAB2 is consumable and you must replace it regularly. It is recommended that a qualified technician carry the lamp unit replacement. Consult with an Authorized Service Center.

#### Note on lamp unit replacement

- Handle the lamp unit with special care as the lamp is made of glass. Dropping or giving it a shock may cause it to burst or damaged.
- The lamp contains mercury. If you wish to discard the used lamp, please contact your local authorities or dealer and ask for the correct method of disposal.
- Prepare a Phillips-head screwdriver.
- When replacing the lamp unit, be sure to hold it by the handle.
- Hold the lamp unit horizontally to prevent broken pieces from scattering. When the projector is mounted in the ceiling, do not work directly under the projector or put your face close to the projector. Pull out the lamp vertically.

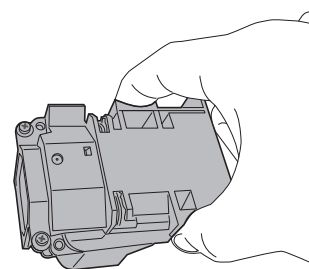



#### **NOTE:**

- Prior to replacing the lamp unit, allow it to cool down to prevent the risk of burns, damage and other hazards.
- Do not attempt replacement of an unauthorized lamp unit.
- The model Nos. of the accessories and the parts sold separately are subject to change without notice.

#### Lamp unit replacement time

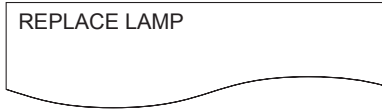
When the lamp has expired, the brightness may decrease over time. 4 000 hours of use is a rough guide of the replacing time and that might be shortened due to usage conditions, specifications of the lamp unit or environmental conditions. You can check the duration of usage time by checking **LAMP RUNTIME** in the **PROJECTOR SETUP** menu. Do not use a lamp unit over 5 000 hours. Failure to observe this may result in explosion of the lamp.

	ON-SCREEN DISPLAY	LAMP indicator
		
<b>3 800 hours</b>	Display “ <b>REPLACE LAMP</b> ” at the upper left of the screen for 30 seconds. If any button is pressed within 30 seconds, the message disappears.	Illuminates red, even in the standby mode.
<b>5 000 hours</b>	Display “ <b>REPLACE LAMP</b> ” at the upper left of the screen, and it will stay until you respond. The power is turned off automatically in 10 minutes.	

#### **NOTE:**

- The guide time, 4 000 hours, is a rough estimate based on certain conditions and is not a guaranteed time.

## Care and Replacement (continued)

### Lamp replacement procedure

- When the projector is mounted in the ceiling, do not work directly under the projector or put your face close to the projector.
- Be sure to install the lamp unit and attach the lamp unit cover securely.

**1** Disconnect the power plug from the wall outlet according to “TURN THE PROJECTOR OFF” (⇒ page 23), wait for at least 1 hour and check the bottom if the lamp unit has cooled.

**2** Use a Phillips-head screwdriver to loosen the 1 lamp unit cover screw on the back of the projector until the screw loosen and remove the lamp unit cover.

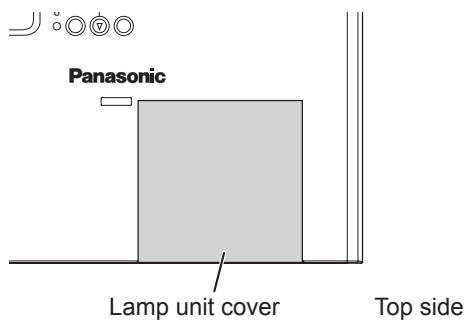
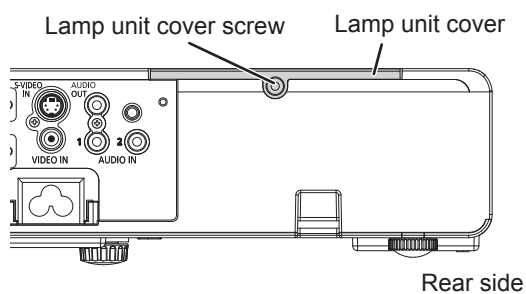

**3** Use a Phillips-head screwdriver to loosen the 2 lamp unit screws. Pull the used lamp unit gently from the projector.

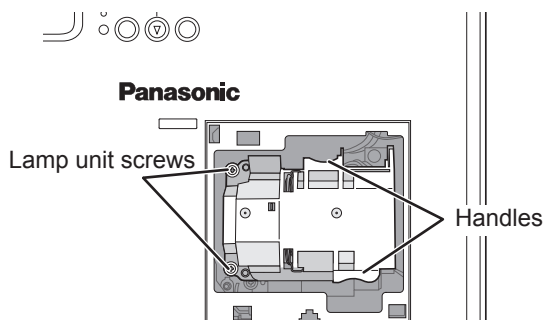

**4** Press in the lamp unit until it clicks and make sure the unit is installed securely. Tighten the 2 lamp unit screws securely with a Phillips-head screwdriver. During insertion, particularly press the (A) portion securely.

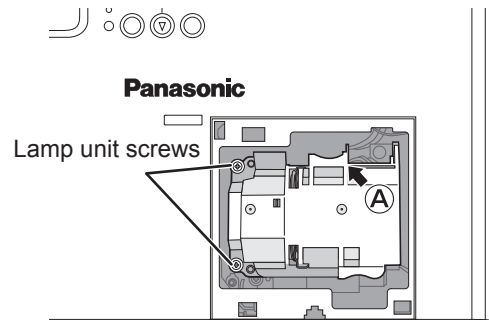

**5** Attach the lamp unit cover and tighten the 1 lamp unit cover screw securely with a Phillips-head screwdriver.

**6** Connect the power cord to a wall outlet.

**7** Press [POWER] to begin projection.

#### NOTE:

- If INITIAL START UP in the PROJECTOR SETUP menu is set to ON, the projector starts projecting when the power cord is connected to a wall outlet. (⇒ page 39)

**8**



To display the main menu.



To scroll to the PROJECTOR SETUP menu.



## Care and Replacement (continued)

9



To select the **PROJECTOR SETUP** menu.



To select **LAMP RUNTIME**.

### NOTE:

- If any button other than the **[POWER]** is pressed, the **LAMP RUNTIME** screen disappears and the lamp runtime is not reset. (Repeat from step 8 again).

11



After the lamp goes off, projection stops and the **[POWER]** button on the main unit lit red. Disconnect the power plug. The lamp runtime has been reset to "0".

10



Press and hold for approximately **3 seconds**.

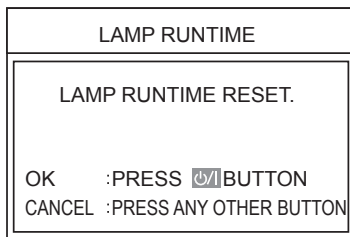

## Ceiling mount bracket safeguards

- Installation work of the ceiling mount bracket should only be carried by a qualified technician.
- Even if it is during guaranteed period, the manufacturer is not responsible for any hazard or damage caused by using a ceiling mount bracket which is not purchased from an authorized distributors, or environmental conditions.
- Remove an unused ceiling mount bracket promptly.
- Ensure to use a torque driver and do not use an electrical screwdriver or an impact screwdriver.
- For details, see the work instruction manual packed together with the ceiling mount bracket.
- The model Nos. of the accessories and the parts sold separately are subject to change without notice.

Model No. of ceiling mount bracket: ET-PKB2

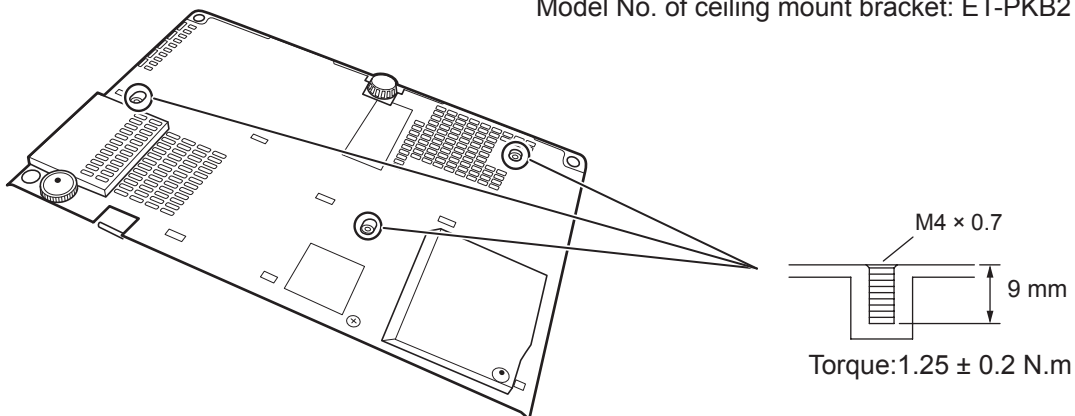

## Troubleshooting

Confirm the following problem and cause.

If the suggested solutions do not solve the problem, contact an Authorized Service Center.

Problem	Cause	Page
Power does not turn on.	● The power cord may not be connected securely.	20
	● No electric supply at the wall outlet.	—
	● The circuit breakers have tripped.	—
	● <b>TEMP</b> or <b>LAMP</b> indicator is lit or flashes.	45
	● The lamp unit cover has not been securely installed.	48
	● <b>CONTROL PANEL</b> in the <b>PROJECTOR SETUP</b> menu is invalidated.	44
No picture appears.	● The lens cover is not removed.	—
	● The input terminal may not be connected properly.	18, 19
	● The input selection setting may not be correct.	24
	● The <b>BRIGHTNESS</b> adjustment setting may be at the minimum setting.	30
	● The signal input source may not be operating properly.	—
● The <b>AV MUTE</b> function may be in use.	25	
The picture is fuzzy.	● The lens focus may not have been set correctly.	24
	● The projector may not be at the correct distance from the screen.	16
	● The lens may be dirty.	46
	● The projector may be tilted too much.	24
Color is pale or grayish.	● <b>COLOR</b> or <b>TINT</b> adjustment may be incorrect.	31
	● The input source which is connected to the projector may not be adjusted correctly.	—
No sound can be heard from the internal speaker.	● The audio signal source may not be connected properly.	18, 19
	● The volume adjustment may be at the lowest possible setting.	26, 40
	● A cable may be connected to the <b>AUDIO OUT</b> terminal.	14
The remote control does not operate.	● The batteries may be weak.	—
	● The batteries may not have been inserted correctly.	15
	● The remote control signal receptor on the projector may be obstructed.	15
	● The remote control unit may be out of the operation range.	15
	● <b>REMOTE CONTROLLER</b> in the <b>PROJECTOR SETUP</b> menu is invalidated.	44
● The remote control is under a strong light such as fluorescent.	15	
The control buttons of the projector do not operate.	● <b>CONTROL PANEL</b> in the <b>PROJECTOR SETUP</b> menu is invalidated. (If you have a loss of the remote control while the <b>CONTROL PANEL</b> is invalidated, press and hold <b>[MENU]</b> for 2 seconds by pressing <b>[ENTER]</b> .)	44
The picture does not display correctly.	● The signal format ( <b>TV-SYSTEM, RGB/YPbPr</b> ) may not have been set correctly.	31, 32
	● There may be a problem with the VCR or other signal source.	—
	● A signal which is not compatible with the projector is being input.	52
Picture from a computer does not appear.	● The RGB signal cable is too long. (Limit to 10 m (32' 10").)	—
	● The external video output from a laptop computer may not be correct. (You may be able to change the external output settings by pressing the <b>[Fn] + [F3]</b> or <b>[Fn] + [F10]</b> keys simultaneously. The actual method varies depending on the type of computer; refer to the documentation provided with your computer for further details.)	36
The projector cannot be controlled through serial terminal.	● <b>EMULATE</b> in the <b>PROJECTOR SETUP</b> menu is not set correctly. (If you fail to select your product series, ask your dealer for repair.)	40

## Dimensions

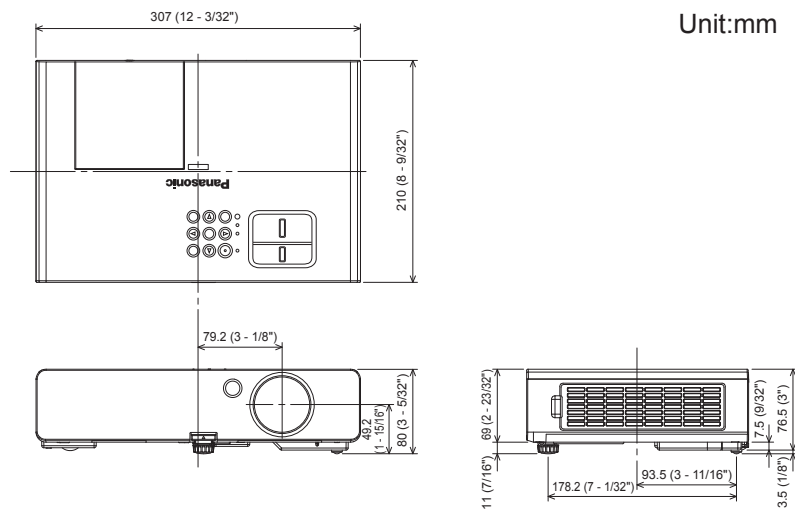

## Trademark acknowledgements

- VGA and XGA are trademarks of International Business Machines Corporation.
- S-VGA is a registered trademark of the Video Electronics Standards Association.
- HDMI, the HDMI logo and High-Definition Multimedia Interface are trademarks or registered trademarks of HDMI Licensing LLC.
- The font used in the on-screen displays is a Ricoh bitmap font, which is manufactured and sold by Ricoh Company, Ltd.

All other trademarks are the property of the various trademark owners.

# Technical information

## LIST OF COMPATIBLE SIGNALS

This projector can project the following image signals.

Mode	Display resolution (dots)*1	Scanning frequency		Dot clock frequency (MHz)	Picture quality*2	PnP availability*3	Terminals	
		H (kHz)	V (Hz)					
NTSC/NTSC4.43/ PAL-M/PAL60	720 × 480i	15.7	59.9	—	A		VIDEO/S-VIDEO	
PAL/PAL-N/SECAM	720 × 576i	15.6	50	—	A			
525i (480i)	720 × 480i	15.7	59.9	13.5	A		RGB/YPbPr	
625i (576i)	720 × 576i	15.6	50	13.5	A			
525p (480p)	720 × 483	31.5	59.9	27	A			
625p (576p)	720 × 576	31.3	50	27	A			
1 125 (1 080)/60i	1 920 × 1 080i	33.8	60	74.3	A			
1 125 (1 080)/50i	1 920 × 1 080i	28.1	50	74.3	A			
1 125 (1 080)/60p	1 920 × 1 080p	67.5	60.0	148.5	A	O		
1 125 (1 080)/50p	1 920 × 1 080p	56.3	50.0	148.5	A	O		
750 (720)/60p	1 280 × 720	45	60	74.3	A			
750 (720)/50p	1 280 × 720	37.5	50	74.3	A			
VESA	640 × 400	31.5	70.1	25.2	A			RGB
	640 × 400	37.9	85.1	31.5	A			
VGA	640 × 480	31.5	59.9	25.2	A	O		
	640 × 480	35	66.7	30.2	A	O		
	640 × 480	37.9	72.8	31.5	A	O		
	640 × 480	37.5	75	31.5	A	O		
	640 × 480	43.3	85	36	A			
SVGA	800 × 600	35.2	56.3	36	A	O		
	800 × 600	37.9	60.3	40	A	O		
	800 × 600	48.1	72.2	50	A	O		
	800 × 600	46.9	75	49.5	A	O		
MAC	832 × 624	49.7	74.6	57.3	A	O		
	XGA	1 024 × 768	39.6	50.1	51.9	AA		
		1 024 × 768	48.4	60	65	AA	O	
		1 024 × 768	56.5	70.1	75	AA	O	
1 024 × 768		60	75	78.8	AA	O		
1 024 × 768		68.7	85	94.5	AA			
MXGA	1 152 × 864	64	71.2	94.2	A	O		
	1 152 × 864	67.5	74.9	108	A			
	1 152 × 864	77.1	85	119.7	A			
MAC	1 152 × 870	68.7	75.1	100	A	O		
MSXGA	1 280 × 960	60	60	108	A	O		
SXGA	1 280 × 1 024	64	60	108	A			
	1 280 × 1 024	80	75	135	A	O		
	1 280 × 1 024	91.1	85	157.5	A			
SXGA60+	1 400 × 1 050	64	60	108	A			
	1 400 × 1 050	65.1	59.9	122.4	A	O		
UXGA	1 600 × 1 200	75	60	162	A	O		
WIDE750 (720)	1 280 × 720	44.8	59.9	74.5	A	O		
	1 280 × 720	37.1	49.8	60.5	A			
WXGA768	1 280 × 768	39.6	49.9	65.3	A			
	1 280 × 768	47.8	59.9	79.5	A	O		
WXGA800	1 280 × 800	41.3	50	68	A			
	1 280 × 800	49.1	60.2	69.1	A	O		
	1 280 × 800	49.7	59.8	83.5	A			
WXGA+	1 440 × 900	55.9	59.9	106.5	A	O		
WSXGA+	1 680 × 1 050	65.3	60	146.3	A	O		
WUXGA	1 920 × 1 200	74.6	59.9	193.3	B			

\*1 The "i" appearing after the resolution indicates an interlaced signal.

\*2 The following symbols are used to indicate picture quality.

AA : Maximum picture quality can be obtained.

A : Signals are converted by the image processing circuit before picture is projected.

B : Some loss of data occurs to make projection easier.

\*3 The signals marked with circles (O) can be applied by plug-and-play device.

## Technical Information (continued)

### SERIAL TERMINAL

The serial connector which is on the connector panel of the projector conforms to the RS-232C interface specifications. The projector can be controlled by a personal computer which is connected to this connector.

#### Connection

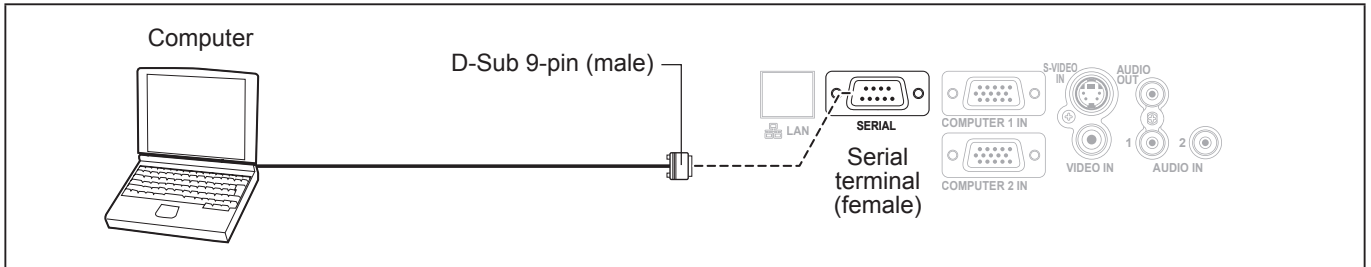

#### Pin assignments and signal names

	Pin No.	Signal name	Contents
	①		NC
	②	TXD	Transmitted data
	③	RXD	Received data
	④		NC
	⑤	GND	Earth
	⑥		NC
	⑦	RTS	Connected internally
	⑧	CTS	
	⑨		NC

#### Communication settings

Signal level	RS-232C
Sync.method	Asynchronous
Baud rate	9 600 bps
Parity	None

Character length	8 bits
Stop bit	1 bit
X parameter	None
S parameter	None

#### Basic format

<table border="1" style="margin-left: auto; margin-right: auto;"> <tr> <td style="text-align: center;">STX</td> <td style="text-align: center;">Command</td> <td style="text-align: center;">:</td> <td style="text-align: center;">Parameter</td> <td style="text-align: center;">ETX</td> </tr> <tr> <td style="text-align: center;">Start byte (02 h)</td> <td style="text-align: center;">3 bytes</td> <td style="text-align: center;">1 byte</td> <td style="text-align: center;">1 bytes - 4 bytes</td> <td style="text-align: center;">End (03 h)</td> </tr> </table>	STX	Command	:	Parameter	ETX	Start byte (02 h)	3 bytes	1 byte	1 bytes - 4 bytes	End (03 h)	<p>The data streaming from the computer will start with STX, and proceed to Command, Parameter and end with ETX. You can add the required parameter.</p>
STX	Command	:	Parameter	ETX							
Start byte (02 h)	3 bytes	1 byte	1 bytes - 4 bytes	End (03 h)							

#### NOTE:

- The projector cannot receive any command for 10 seconds after the lamp is switched on. Wait for 10 seconds before sending the command.
- For multiple commands, check the projector if the response has been sent for one command before sending the next command.
- When a command which does not require parameters to be sent, the colon (:) is not required.
- If an incorrect command is sent from the personal computer, an ER401 command will be sent from the projector to the personal computer.

## Technical Information (continued)

### Cable specifications

(When connected to a personal computer)

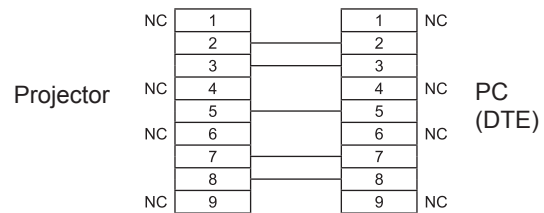

### Control commands

The following commands are used for control of the projector with a computer. (Operation commands)

Command	Control contents	Remarks
<b>PON</b>	Power on	<ul style="list-style-type: none"> <li>The PON command is ignored during lamp ON control.</li> <li>If a PON command is received while the cooling fan is operating after the lamp has switched off, the lamp is not turned back on again straight away in order to protect the lamp.</li> </ul>
<b>POF</b>	Power off	
<b>AVL</b>	Volume	Parameter: 000 - 063 (Adjustment value 0 - 63)
<b>IIS</b>	Input	Parameter: VID = VIDEO    SVD = S-VIDEO    RG1 = COMPUTER 1 IN RG2 = COMPUTER 2 IN
<b>Q\$\$</b>	Lamp condition query	Call back: 0 = Standby    1 = Lamp on control active    2 = Lamp on    3 = Lamp off control active
<b>OSH</b>	AV mute	Turn off the projection and sound temporarily. Send the command to switch between off and on. (⇒ page 25) Do not send the command consecutively. 0 = Off    1 = On

#### NOTE:

- If **STANDBY MODE** is set to **ECO**, only **PON** and **Q\$\$** command can be used in the standby mode.

## MENU LOCK PASSWORD

To reset the password to the default setting **AAAA**, perform the following when the **MENU LOCK PASSWORD** request screen is displayed.

- Press and hold the **<AUTO SETUP>** button of the remote control or the **<INPUT SELECT>** button of the control panel and the **▲** button of the control panel together for at least 2 seconds.
- Press and hold **▼** button for at least 2 seconds.  
**PASSWORD HAS BEEN INITIALIZED.** is displayed on the **MENU LOCK PASSWORD** request screen.

## Specifications

<b>Power supply</b>		AC 100 - 240 V 50 Hz/60 Hz
<b>Power consumption</b>		300 W During standby (when fan is stopped): 0.4 W (STANDBY MODE: ECO) 15 W *1 (STANDBY MODE: NORMAL)
<b>Current</b>		3.5 A - 1.2 A
<b>LCD panel</b>	<b>Panel size (diagonal)</b>	16.00 mm (0.63")
	<b>Aspect ratio</b>	4:3
	<b>Display method</b>	3 transparent LCD panels (RGB)
	<b>Drive method</b>	Active matrix method
	<b>Pixels</b>	786 432 (1 024 × 768) × 3 panels
<b>Lens</b>		Manual zoom (1.2×)/Manual focus F 1.64 - 1.87, f 18.8 mm - 22.56 mm (PT-LB3E/PT-LB2E) F 2.0 - 2.2, f 19.22 mm - 22.68 mm (PT-LB1E)
<b>Lamp</b>		UHM lamp (220 W)
<b>Luminosity</b> *2		3 200 lm (PT-LB3E) 2 600 lm (PT-LB2E) 2 200 lm (PT-LB1E)
<b>Scanning frequency</b> *3 (for RGB signal)	<b>Horizontal scanning frequency</b>	15 kHz - 91 kHz
	<b>Vertical scanning frequency</b>	50 Hz - 85 Hz
	<b>Dot clock frequency</b>	Less than 170 MHz
<b>COMPONENT (YP<sub>B</sub>PR) signals</b>		525i (480i), 525p (480p), 625i (576i), 625p (576p), 750 (720)/60p, 750 (720)/50p, 1 125 (1 080)/60i, 1 125 (1 080)/60p, 1 125 (1 080)/50i, 1 125 (1 080)/50p
<b>Color system</b>		7 (NTSC/NTSC4.43/PAL/PAL-M/PAL-N/PAL60/SECAM)
<b>Projection size</b>		838.2 mm - 7 620 mm (33" - 300")
<b>Optical axis</b>		5:1 fixed
<b>Throw distance</b>		1.1 m - 11.5 m (3'7" - 37'8") (PT-LB3E/PT-LB2E) 1.1 m - 11.7 m (3'7" - 38'4") (PT-LB1E)
<b>Screen aspect ratio</b>		4:3
<b>Installation</b>		FRONT/DESK, FRONT/CEILING, REAR/DESK, REAR/CEILING (Menu selection method)
<b>Speaker</b>		1 piece 4 cm × 2 cm (1 5/8" × 3/4")
<b>Max. useable volume output</b>		1.0 W (Monaural)
<b>Terminals</b>	<b>S-VIDEO IN</b>	Single - line, Mini DIN 4p Y: 1.0 V [p-p], C: 0.286 V [p-p], 75 Ω
	<b>VIDEO IN</b>	Single - line, RCA pin jack 1.0 V [p-p], 75 Ω
	<b>COMPUTER IN</b>	Dual - line, D-Sub HD 15-pin (female) ● RGB input R.G.B.: 0.7 V [p-p], 75 Ω G-SYNC: 1.0 V [p-p], 75 Ω HD, VD/SYNC: TTL high impedance, automatic positive/negative polarity compatible ● YP <sub>B</sub> PR/YC <sub>B</sub> CR input Y: 1.0 V [p-p] (include sync), 75 Ω P <sub>B</sub> /C <sub>B</sub> , P <sub>R</sub> /C <sub>R</sub> : 0.7 V [p-p], 75 Ω
	<b>AUDIO IN</b>	Dual - line, 0.5 V [rms], M3 jack (Stereo MINI)
	<b>AUDIO OUT</b>	Single - line, M3 jack (Stereo MINI) Monitor output/stereo compatible 0 V [rms] - 2.0 V [rms] (variable)
	<b>SERIAL</b>	Single - line, D-Sub 9-pin RS-232C compatible
	<b>LAN (RJ-45)</b>	Single - line, 10Base-T/100Base-TX

\*1 When "IN STANDBY MODE" in AUDIO SETTING menu is ON: 18 W.

\*2 Measurement, measuring conditions and method of notation all comply with ISO21118 international standards.

\*3 See "LIST OF COMPATIBLE SIGNALS" on page 52 for available signals.

## Specifications (continued)

<b>Cabinet</b>	Moulded plastic (PC+ABS)	
<b>Dimensions</b>	<ul style="list-style-type: none"> <li>● Width: 307 mm (12 3/32")</li> <li>● Height: 69 mm (2 23/32")</li> <li>● Length: 210 mm (8 9/32")</li> </ul> (not including surface projection parts)	
<b>Weight</b>	Approx. 2.3 kg (5.1 lbs.) *4	
<b>Operating environment</b>	<ul style="list-style-type: none"> <li>● Temperature: 0 °C - 40 °C (32 °F - 104 °F) When the HIGH ALTITUDE MODE (⇒ page 39) is set to ON: 0 °C - 35 °C (32 °F - 95 °F)</li> <li>● Humidity: 20 % - 80 % (no condensation)</li> </ul>	
<b>Certifications</b>	EN60950-1, EN55022, EN61000-3-2, EN61000-3-3, EN55024	
<b>Remote control</b>	<b>Power supply</b>	3 V DC (AAA/R03 battery × 2)
	<b>Operating range</b>	Approx. 7 m (23' 0") (when operated directly in front of signal receptor)
	<b>Weight</b>	Approx. 64 g (2.3 ozs.) (including batteries)
	<b>Dimensions</b>	<ul style="list-style-type: none"> <li>● Width: 45.6 mm (1 25/32")</li> <li>● Length: 115 mm (4 17/32")</li> <li>● Height: 21.4 mm (27/32") (not including surface projection parts)</li> </ul>
<b>Options</b> *5	<b>Ceiling bracket</b>	ET-PKB2
	<b>Air Filter Unit</b>	ET-KFB2

\*4 Average value. Each product has an individual variability in weight.

\*5 The model Nos. of the accessories and parts sold separately are subject to change without notice.



# Index

<b>A</b>			<b>K</b>			<b>S</b>		
ASPECT .....	33		KEystone .....	32		SCREEN SIZE AND THROW		
AUDIO SETTING.....	40					DISTANCE .....	16	
AUTO SETUP.....	37		<b>L</b>			SECURITY .....	10	
AV MUTE.....	25		LAMP INDICATOR .....	45		SECURITY MENU.....	42	
<b>B</b>			LAMP POWER .....	39		SELECT THE INPUT SIGNAL.....	24	
BACK COLOR .....	37		LAMP RUNTIME .....	40		SERIAL TERMINAL.....	53	
BRIGHTNESS .....	30		LANGUAGE MENU .....	35		SHARPNESS .....	31	
<b>C</b>			LANGUAGE.....	12		SHIFT .....	32	
CAUTIONS ON USE .....	10		LIST OF COMPATIBLE SIGNALS.....	52		SIGNAL SEARCH .....	37	
CAUTIONS WHEN INSTALLING .....	9		<b>M</b>			Specifications .....	55	
CAUTIONS WHEN TRANSPORTING ...	9		MAIN MENU .....	29		STANDBY MODE .....	39	
CLEANING AND MAINTENANCE.....	11		MENU LOCK .....	43		STARTUP LOGO.....	36	
CLEANING THE PROJECTOR.....	46		MENU LOCK PASSWORD .....	43, 54		STATUS.....	38	
CLOCK PHASE .....	33		<b>N</b>			SUB MENU.....	29	
COLOR.....	31		NETWORK MENU.....	44		SUPPLIED ACCESSORIES .....	11	
COLOR TEMPERATURE .....	31		NOISE REDUCTION .....	31		SXGA MODE .....	38	
COMPUTER.....	25		NO SIGNAL SHUT-OFF .....	39		<b>T</b>		
Connections.....	18		<b>O</b>			TABLE OF CONTENTS.....	5	
CONTRAST.....	30		ON-SCREEN DISPLAY .....	35		TEMP INDICATOR .....	45	
CONTROL DEVICE SETUP.....	44		ON-SCREEN MENU .....	28		TEST PATTERN .....	41	
<b>D</b>			OPERATE THE MENU.....	28		TEXT CHANGE .....	42	
DAYLIGHT VIEW.....	31		OTHER FUNCTIONS .....	38		TEXT DISPLAY.....	42	
DEFAULT.....	26		OVER SCAN .....	33		TINT.....	31	
Dimensions.....	51		<b>P</b>			Troubleshooting.....	50	
DISPLAY OPTION MENU .....	35		PASSWORD .....	42		TURN THE PROJECTOR OFF .....	23	
DISPOSAL.....	11		PASSWORD CHANGE .....	42		TURN THE PROJECTOR ON.....	22	
DOT CLOCK.....	32		PICTURE MENU .....	30		TV-SYSTEM .....	31	
<b>E</b>			PICTURE MODE .....	30		<b>V</b>		
EMULATE.....	40		POSITION MENU.....	32		VOLUME .....	26	
ENLARGE THE IMAGE.....	27		POSITION THE IMAGE.....	24		<b>W</b>		
<b>F</b>			POWER CORD .....	20		WHITE BALANCE .....	31	
FRAME LOCK .....	34		POWER indicator status.....	21		WIDE MODE .....	38	
FREEZE .....	25		PROJECTION METHOD.....	17				
FUNCTION BUTTON .....	27, 40		PROJECTOR SETUP MENU.....	38				
<b>H</b>			PROJECTOR'S MAIN UNIT.....	13				
HIGH ALTITUDE MODE.....	39		PROJECTOR'S REMOTE					
<b>I</b>			CONTROL .....	15				
Important Safety Notice.....	2		<b>R</b>					
INDEX-WINDOW.....	26		REALTIME KEystone .....	32				
INITIALIZE ALL.....	41		Remote control operation .....	25				
INITIAL SETTING .....	12		REPLACE THE LAMP UNIT.....	47				
INITIAL START UP .....	39		RGB/YP <sub>b</sub> Pr.....	32				
INSTALLATION .....	39							

## Removal of spacer at rear adjuster

- Remove the spacer before use.

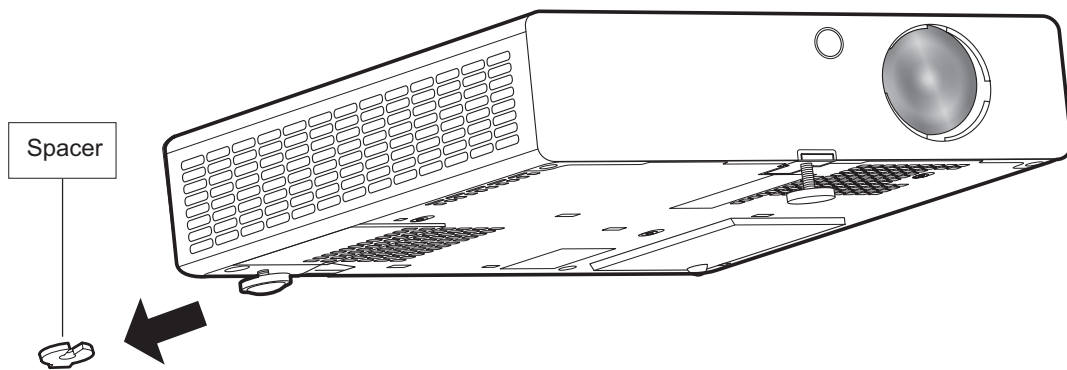

### NOTE:

Keep the spacer away from babies and infants.

- If a baby swallows the spacer by accident, it may be affected badly.
- If a baby seems to have swallowed the spacer, consult the doctor immediately.



---

# Panasonic Corporation

Web Site : <http://panasonic.net/avc/projector/>

© Panasonic Corporation 2011