

# Panasonic<sup>®</sup>

## Owner's Manual High Definition Video Camera

---

Model No. **HC-V180**

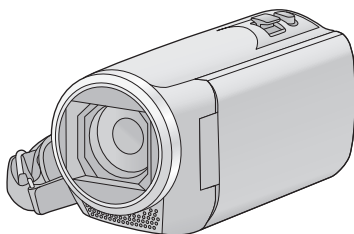

Please read these instructions carefully before using this product,  
and save this manual for future use.

**AVCHD**™  
Progressive

**HDMI**

**SD**™  
**XC**

**DOLBY**  
DIGITAL

Register online at <http://shop.panasonic.com/support> (U.S. customers only)

SQW0490

# Read this first

## ■ About the recording format for recording motion pictures

You can select from AVCHD<sup>\*1</sup>, MP4 or iFrame recording formats to record motion pictures using this unit. (→ 61)

\*1 It is compatible with the AVCHD Progressive (1080/60p).

### AVCHD:

It is suitable for viewing on a high-definition TV or for saving to disc\*<sup>2</sup>.

\*2 The following methods are available for saving an image recorded in 1080/60p:

- Copy the image to a disc using the HD Writer LE 3.0.
- Copy the image to a Panasonic Blu-ray disc recorder that supports AVCHD Progressive.

● Blu-ray recorders are not sold in US.

### MP4:

This is a recording format suitable for playing back or editing on a PC.

● It is not compatible with motion pictures recorded in AVCHD format.

### iFrame:

This is a recording format suitable for playing back or editing on a Mac (iMovie etc.).

● It is not compatible with motion pictures recorded in AVCHD format.

## ■ Indemnity about recorded content

Panasonic does not accept any responsibility for damages directly or indirectly due to any type of problems that result in loss of recording or edited content, and does not guarantee any content if recording or editing does not work properly. Likewise, the above also applies in a case where any type of repair is made to the unit.

## ■ About Condensation (When the lens or the LCD monitor is fogged up)

Condensation occurs when there is a change in temperature or humidity, such as when the unit is taken from outside or a cold room to a warm room. Please be careful, as it may cause the lens or LCD monitor to become soiled, moldy, or damaged.





When taking the unit to a place which has a different temperature, if the unit is accustomed to the room temperature of the destination for about one hour, condensation can be prevented. (When the difference in temperature is severe, place the unit in a plastic bag or the like, remove air from the bag, and seal the bag.) When condensation has occurred, remove the battery and/or the AC adapter and leave the unit like that for about one hour. When the unit becomes accustomed to the surrounding temperature, fogging will disappear naturally.

## ■ Cards that you can use with this unit

### SD Memory Card, SDHC Memory Card and SDXC Memory Card

- 4 GB or more Memory Cards that do not have the SDHC logo or 48 GB or more Memory Cards that do not have the SDXC logo are not based on SD Memory Card Specifications.
- Refer to page 12 for more details on SD cards.

## ■ For the purposes of this owner's manual

- SD Memory Card, SDHC Memory Card and SDXC Memory Card are referred to as the "SD card".
- The smartphone and tablet are indicated as "smartphone".
- Function that can be used for Motion Picture Recording Mode: 
- Function that can be used for Still Picture Recording Mode: 
- Function that can be used for the Playback Mode: 
- Function that can be used for the Playback Mode (motion pictures only): 
- Function that can be used for the Playback Mode (still pictures only): 
- Scene(s) recorded in the recording format [AVCHD]: "AVCHD scene(s)"
- Scene(s) recorded in the recording format [MP4/iFrame], scene(s) saved in MP4 (1280×720/30p) or MP4 (640×360/30p): "MP4/iFrame scene(s)"
- Pages for reference are indicated by an arrow, for example: → 00

# Contents

Read this first .....	2
-----------------------	---

## Preparation

<b>Names and Functions of Main Parts</b> .....	6
<b>Power supply</b> .....	9
Inserting/removing the battery .....	9
Charging the battery .....	10
Charging and recording time .....	11
<b>Recording to a card</b> .....	12
Cards that you can use with this unit .....	12
Inserting/removing an SD card .....	13
<b>Turning the unit on/off</b> .....	14
<b>Selecting a mode</b> .....	15
Switching this unit between Recording Mode and Playback Mode .....	15
Switching this unit between Motion Picture Recording Mode and Still Picture Recording Mode .....	15
<b>How to use the touch screen</b> .....	16
About the Touch Menu .....	17
<b>Setting date and time</b> .....	18

## Basic

<b>Before recording</b> .....	19
<b>Recording motion pictures</b> .....	20
<b>Recording still pictures</b> .....	21
Recording still pictures in Motion Picture Recording Mode .....	23
<b>Motion picture/Still picture playback</b> .....	24
<b>Using the menu screen</b> .....	27
<b>Using the Setup Menu</b> .....	28

## Advanced (Recording)

<b>Using the zoom</b> .....	37
Zoom ratio during the Still Picture Recording Mode .....	37
<b>Level Shot Function</b> .....	38
<b>Changing the Recording Mode</b> .....	39
Intelligent Auto .....	40
Intelligent Auto Plus .....	42
Creative Control .....	42
Scene Mode .....	45
Endless Loop Recording .....	46

<b>Manual recording</b> .....	47
White Balance .....	48
Manual shutter speed/iris adjustment .....	49
Manual Focus adjustment .....	50
<b>Recording with the Touch Function</b> .....	51
Touch function icons .....	51
<b>Recording functions of operation icons</b> .....	56
Operation icons .....	56
<b>Recording functions of menus</b> .....	60

## Advanced (Playback)

<b>Playback Operations</b> .....	68
Motion picture playback using operation icon .....	68
Creating still picture from motion picture .....	69
Highlight & Time Frame Index .....	70
Repeat Playback .....	70
Resuming the previous playback .....	71
Zooming in on a still picture during playback (Playback zoom) .....	71
<b>Various playback functions</b> .....	72
Playing back motion pictures/ still pictures by date .....	72
Highlight Playback .....	73
Manual Edit .....	79
Baby Calendar .....	82
Changing the playback settings and playing back the slide show .....	84
<b>Deleting scenes/still pictures</b> .....	85
Deleting part of a scene (AVCHD) .....	86
Dividing a scene (AVCHD) .....	87
Dividing a scene to partially delete (MP4/iFrame) .....	88
Protecting scenes/still pictures .....	88
<b>Convert to MP4</b> .....	89
<b>Watching Video/Pictures on your TV</b> .....	90
Connecting with an HDMI mini cable .....	92
<b>Playback using VIERA Link</b> .....	93

---

## Copy/Dubbing

---

<b>Copying/playing back with a USB HDD</b> .....	<b>95</b>
Preparing for copying/playing back .....	95
Simple copy .....	97
Copy selected files .....	98
Playing back the USB HDD .....	99
<b>Dubbing with a Blu-ray disc recorder, video device, etc.</b> .....	<b>100</b>
<b>Using the Eye-Fi™ card</b> .....	<b>104</b>

---

## With a PC

---

<b>What you can do with a PC</b> .....	<b>107</b>
Before Installing HD Writer LE 3.0 .....	109
<b>Operating environment</b> .....	<b>111</b>
<b>Installation</b> .....	<b>113</b>
<b>Connecting to a PC</b> .....	<b>114</b>
About the PC display .....	116
<b>Starting HD Writer LE 3.0</b> .....	<b>117</b>
Reading the operating instructions of the software applications .....	117
<b>If using Mac (mass storage)</b> .....	<b>118</b>

---





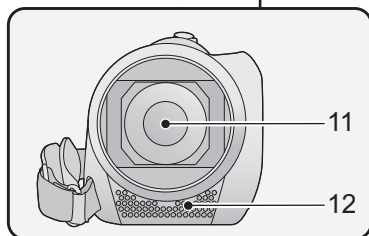
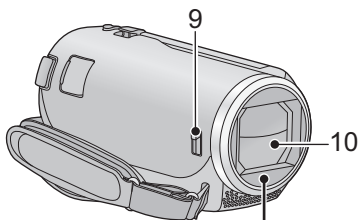
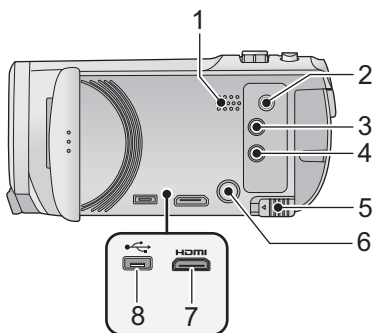

## Others

---

<b>Indications</b> .....	<b>119</b>
<b>Messages</b> .....	<b>122</b>
About recovery .....	122
<b>Troubleshooting</b> .....	<b>123</b>
<b>Cautions for use</b> .....	<b>128</b>
<b>About copyright</b> .....	<b>132</b>
<b>Recording modes/approximate recordable time</b> .....	<b>133</b>
<b>Approximate number of recordable pictures</b> .....	<b>134</b>
<b>Optional accessories</b> .....	<b>135</b>
About the Remote Pan Tilt Cradle .....	135

# Names and Functions of Main Parts



- 1 **Speaker**
- 2 **A/V connector [A/V]** (→ 90, 103)
- 3 **Recording/playback button** [  /  ] (→ 15)
- 4 **Level Shot Function button** [  /  ] (→ 38)
- 5 **Battery release lever [BATT]** (→ 9)
- 6 **Power button** [  /  ] (→ 14)
- 7 **HDMI mini connector [HDMI]** (→ 90)
- 8 **USB terminal** [  ] (→ 95, 101, 114)

## 9 Lens cover opening/closing switch

When not using the unit, close the lens cover to protect the lens.

- Slide the opening/closing switch to open/close the cover.

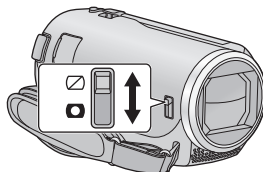

- 10 **Lens cover**
- 11 **Lens**
- 12 **Internal stereo microphones**

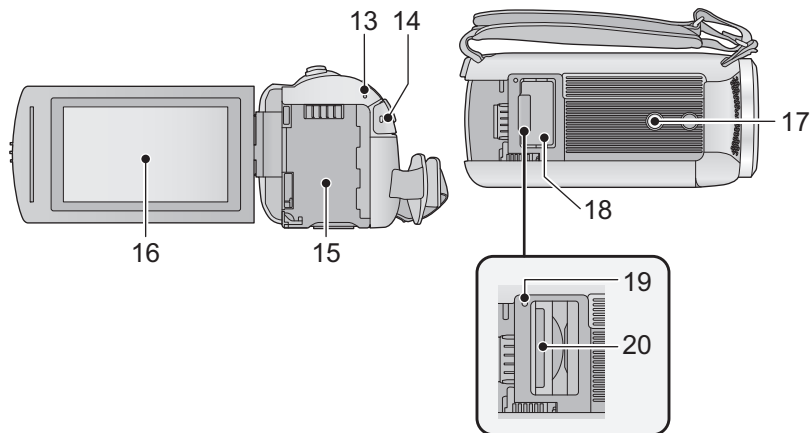

- 13 Status indicator (→ 14)
- 14 Recording start/stop button (→ 20)
- 15 Battery holder (→ 9)
- 16 LCD monitor (Touch screen) (→ 16)

- 17 Tripod receptacle
  - Attaching a tripod with a screw length of 5.5 mm (0.22 ") or more may damage the unit.
- 18 SD card cover (→ 13)
- 19 Access lamp [ACCESS] (→ 13)
- 20 Card slot (→ 13)

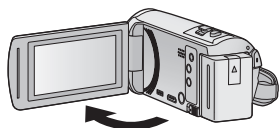

- It can open up to 90°.

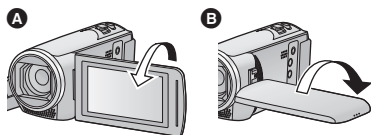

- It can rotate up to 180° **A** towards the lens or 90° **B** towards the opposite direction.

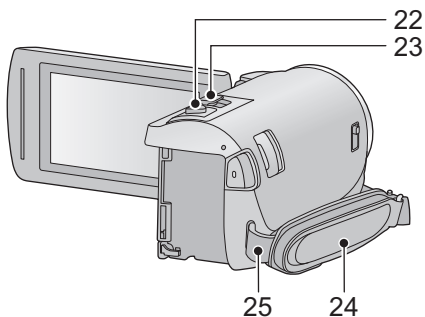
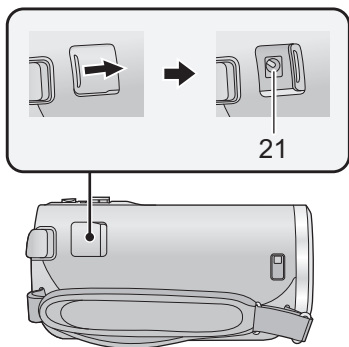



**21 DC input terminal [DC IN] (→ 10)**

- Do not use any other AC adaptors except the supplied one.

**22 Photoshot button [  ] (→ 21)**

**23 Zoom lever [W/T] (In Motion Picture Recording Mode or Still Picture**

**Recording Mode) (→ 37)/**

**Thumbnail display switch [  /  ]**

**(→ 25)/**

**Volume lever [-VOL+] (In Playback Mode) (→ 26)**

**24 Grip belt**

Adjust the length of the grip belt so that it fits your hand.

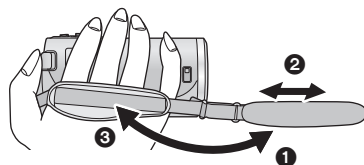

- 1 Flip the belt.
- 2 Adjust the length.
- 3 Replace the belt.

**25 Shoulder strap fixture**



## Power supply

### ■ About batteries that you can use with this unit

The battery that can be used with this unit is VW-VBT190/VW-VBT380.

- The unit has a function for distinguishing batteries which can be used safely. The dedicated battery (VW-VBT190/VW-VBT380) supports this function. The only batteries suitable for use with this unit are genuine Panasonic products and batteries manufactured by other companies and certified by Panasonic. Panasonic cannot in any way guarantee the quality, performance or safety of batteries which have been manufactured by other companies and are not genuine Panasonic products.

It has been found that counterfeit battery packs which look very similar to the genuine product are made available to purchase in some markets. Some of these battery packs are not adequately protected with internal protection to meet the requirements of appropriate safety standards. There is a possibility that these battery packs may lead to fire or explosion. Please be advised that we are not liable for any accident or failure occurring as a result of use of a counterfeit battery pack. To ensure that safe products are used we would recommend that a genuine Panasonic battery pack is used.

## Inserting/removing the battery

- Press the power button to turn off the unit. (→ 14)

Install the battery by inserting it in the direction shown in the figure.

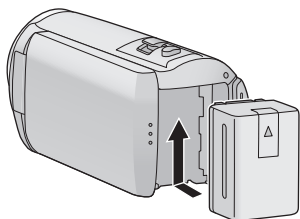

Insert the battery until it clicks and locks.

### Removing the battery

Be sure to hold down the power button until the status indicator goes off. Then remove the battery while supporting the unit to prevent it from dropping.

**Move the battery release lever in the direction indicated by the arrow and remove the battery when unlocked.**

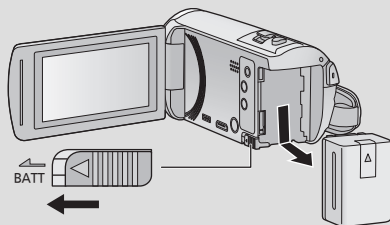

# Charging the battery

**When this unit is purchased, the battery is not charged. Charge the battery fully before using this unit for the first time.**

The unit is in the standby condition when the AC adaptor is connected. The primary circuit is always "live" as long as the AC adaptor is connected to an electrical outlet.

## Important:

- Do not use the AC adaptor/DC cable with any other equipment as it is designed only for this unit. Also, do not use the AC adaptor/DC cable from other equipment with this unit.
- The battery will not be charged if the unit is turned on.
- It is recommended to charge the battery in a temperature between 10 °C and 30 °C (50 °F and 86 °F). (The battery temperature should also be the same.)

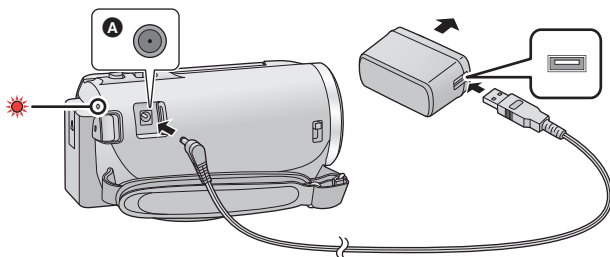

**A** DC input terminal

**1** Connect the DC cable to the AC adaptor and to the DC input terminal of this unit.

- Insert the plugs as far as they will go.

**2** Insert the AC adaptor into an AC outlet.

- The status indicator will flash red at an interval of approximately 2 seconds (approximately 1 second on, approximately 1 second off), indicating that charging has begun. It will turn off when the charging is completed.

## ■ Connecting to the AC outlet

It is possible to use this unit with power supplied from the AC outlet by turning on the unit with the AC adaptor connected.

Even when you use the AC adaptor for recording images, keep the battery connected.

This allows you to continue the recording even if a power failure occurs or the AC adaptor is unplugged from the AC outlet by accident.

## ■ To charge by connecting to other device

It is possible to charge by connecting to other device with the USB cable (supplied).

Please refer to page [115](#).

- If the status indicator flashes at a particularly fast or slow rate, refer to page [130](#).
- We recommend using Panasonic batteries (→ [11](#)).
- If you use other batteries, we cannot guarantee the quality of this product.
- Do not heat or expose to flame.
- Do not leave the battery(ies) in a car exposed to direct sunlight for a long period of time with doors and windows closed.

# Charging and recording time

## ■ Charging/Recording time







- Temperature: 25 °C (77 °F)/humidity: 60%RH
- Charging times in parentheses are when charging from the USB terminal.

Battery model number [Voltage/Capacity (minimum)]	Charging time	Recording format	Recording mode	Maximum continuous recordable time	Actual recordable time
Supplied battery/ VW-VBT190 (optional) [3.6 V/1940 mAh]	2 h 20 min (5 h 20 min)	[AVCHD]	[1080/60p]	2 h	1 h
			[PH], [HA]	2 h 5 min	1 h 5 min
			[HG], [HE]	2 h 10 min	
		[MP4/ iFrame]	[1080]	2 h	1 h
			[720]	2 h 30 min	1 h 15 min
		[iFrame]	2 h 35 min	1 h 20 min	
VW-VBT380 (optional) [3.6 V/3880 mAh]	3 h 45 min (9 h 45 min)	[AVCHD]	[1080/60p]	4 h 10 min	2 h 10 min
			[PH]	4 h 15 min	
			[HA]	4 h 15 min	2 h 15 min
			[HG], [HE]	4 h 20 min	
		[MP4/ iFrame]	[1080]	4 h 5 min	2 h 5 min
			[720]	5 h	2 h 35 min
			[iFrame]	5 h 15 min	2 h 40 min

- “h” is an abbreviation for hour, “min” for minute and “s” for second.
- These times are approximations.
- **The indicated charging time is for when the battery has been discharged completely. Charging time and recordable time vary depending on the usage conditions such as high/low temperature.**

- The actual recordable time refers to the recordable time when repeatedly starting/stopping recording, turning the unit on/off, moving the zoom lever etc.
- The batteries heat up after use or charging. This is not a malfunction.

## Battery capacity indication

- The display changes as the battery capacity reduces.  →  →  →  →   
If the battery discharges, then  will flash red.

## Recording to a card

The unit can record still pictures or motion pictures to an SD card. To record to an SD card, read the following.

### Cards that you can use with this unit

Use SD cards conforming to Class 4 or higher of the SD Speed Class Rating\* for motion picture recording.

Card type	Capacity
SD Memory Card	512 MB to 2 GB
SDHC Memory Card	4 GB to 32 GB
SDXC Memory Card	48 GB to 128 GB

\* SD Speed Class Rating is the speed standard regarding continuous writing. Check via the label on the card, etc.

e.g.:



- Please check the latest information on the support website below.

[http://panasonic.jp/support/global/cs/e\\_cam](http://panasonic.jp/support/global/cs/e_cam)

(This website is in English only.)

- **When using an SDHC Memory Card/SDXC Memory Card with other equipment, check the equipment is compatible with these Memory Cards.**
- An Eye-Fi X2 series SD card is required to use functions related to Eye-Fi. (→ 104)
- We do not guarantee the operation of SD cards other than the ones above. Further, SD cards with a capacity of less than 32 MB cannot be used for motion picture recording.
- 4 GB or more Memory Cards that do not have the SDHC logo or 48 GB or more Memory Cards that do not have the SDXC logo are not based on SD Memory Card Specifications.
- When the write-protect switch **A** on SD card is locked, no recording, deletion or editing will be possible on the card.
- Keep the Memory Card out of reach of children to prevent swallowing.



# Inserting/removing an SD card

When using an SD card not from Panasonic, or one previously used on other equipment, for the first time on this unit, format the SD card. (→ 34) When the SD card is formatted, all of the recorded data is deleted. Once the data is deleted, it cannot be restored.

## Caution:

Check that the access lamp has gone off.

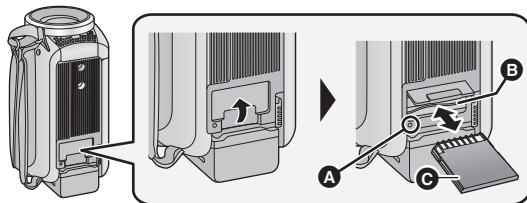

## Access lamp [ACCESS] **A**

- When this unit is accessing the SD card, the access lamp lights up.

## 1 Open the SD card cover and insert (remove) the SD card into (from) the card slot **B**.

- Face the terminal side **C** in the direction shown in the illustration and press it straight in as far as it will go.
- Press the center of the SD card and then pull it straight out.

## 2 Securely close the SD card cover.

- Securely close it until it clicks.

- Do not touch the terminals on the back of the SD card.
- Do not apply strong shocks, bend, or drop the SD card.
- Electrical noise, static electricity or the failure of this unit or the SD card may damage or erase the data stored on the SD card.
- When the card access lamp is lit, do not:
  - Remove the SD card
  - Turn the unit off
  - Insert and remove the USB cable
  - Expose the unit to vibrations or shockPerforming the above while the lamp is on may result in damage to data/SD card or this unit.
- Do not expose the terminals of the SD card to water, dirt or dust.
- Do not place SD cards in the following areas:
  - In direct sunlight
  - In very dusty or humid areas
  - Near a heater
  - Locations susceptible to significant difference in temperature (condensation can occur.)
  - Where static electricity or electromagnetic waves occur
- To protect SD cards, return them to their cases when you are not using them.
- About disposing of or giving away the SD card. (→ 130)

## Turning the unit on/off

You can turn the unit on and off using the power button or by opening and closing the LCD monitor.

### Turning the unit on and off with the power button

Open the LCD monitor and press the power button to turn on the unit.

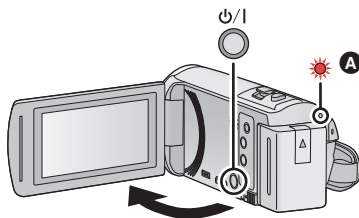

#### To turn off the unit

Hold down the power button until the status indicator goes off.

**A** The status indicator lights on.

### Turning the unit on and off with the LCD monitor

The unit is turned on when the LCD monitor is opened, and unit is turned off when it is closed.

**During normal use, opening and closing of the LCD monitor can be conveniently used to turn the unit on/off.**

- The unit will not turn off while recording motion pictures even if the LCD monitor is closed.
- In the following cases, opening the LCD monitor does not turn on the unit. Press the power button to turn on the unit.
  - When the unit is originally purchased
  - When you have turned off the unit using the power button

## Selecting a mode

You can switch this unit between Recording Mode (Motion Picture Recording Mode/Still Picture Recording Mode) and Playback Mode by pressing the recording/playback button.

If you touch the recording mode switching icon in Recording Mode, this unit can be switched between Motion Picture Recording Mode and Still Picture Recording Mode.

<b>Motion Picture Recording Mode (→ 20)</b>	<b>Recording motion pictures.</b>
<b>Still Picture Recording Mode (→ 21)</b>	<b>Recording still pictures.</b>
<b>Playback Mode (→ 24, 68)</b>	<b>Motion picture/Still picture playback.</b>

## Switching this unit between Recording Mode and Playback Mode

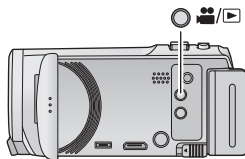

### Recording/playback button

Press the button to switch this unit between Recording Mode and Playback Mode.

- When you turn on this unit, it starts up in Recording Mode.

## Switching this unit between Motion Picture Recording Mode and Still Picture Recording Mode

Touch the recording mode switching icon displayed on the LCD monitor (touch screen) to switch this unit between Motion Picture Recording Mode and Still Picture Recording Mode.

### 1 Press the recording/playback button to switch this unit to Recording Mode.

- The recording mode switching icon **A** is displayed on the screen.

	Motion Picture Recording Mode
	Still Picture Recording Mode



(Motion Picture Recording Mode)

### 2 Touch the recording mode switching icon.

- Refer to page 16 for touch screen operation.

## To display the recording mode switching icon

Display of the recording mode switching icon will disappear when no touch operation is performed for a specific period of time. To display it again, touch the screen.

- If the recording start/stop button is pressed in Still Picture Recording Mode or Playback Mode, this unit will be switched to Motion Picture Recording Mode. During motion picture/still picture playback or in other conditions, even if the recording start/stop button is pressed, the recording mode may not be switched.
- When you switch from Still Picture Recording Mode to Motion Picture Recording Mode or vice versa, settings used in the original recording mode may not be maintained. (→ 39)

### Preparation

## How to use the touch screen

You can operate by directly touching the LCD monitor (touch screen) with your finger.

### ■ Touch

Touch and release the touch screen to select icon or picture.

- Touch the center of the icon.
- Touching the touch screen will not operate while you are touching another part of the touch screen.

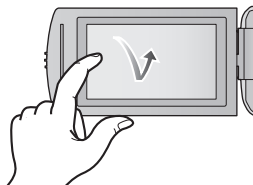

### ■ Slide while touching

Move your finger while pressing on the touch screen.

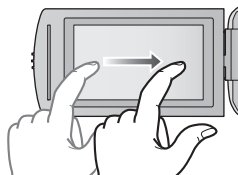

### ■ About the operation icons

▲ / ▼ / ◀ / ▶ :

Touch when changing a page or performing settings.

↶ :

Touch to return to the previous screen.





# About the Touch Menu

Touch ◀ (left side)/▶ (right side) of  on the Touch Menu to switch the operation icons.

- It is also possible to switch the operation icons by sliding the Touch Menu right or left while touching it.

## A Touch Menu

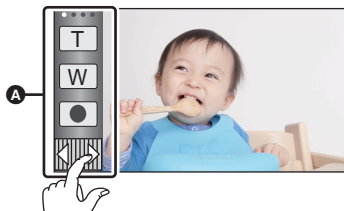

Recording Mode

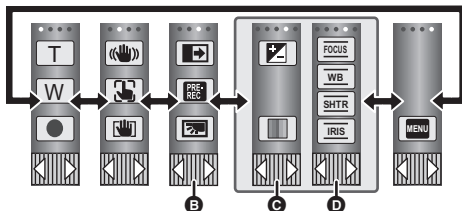

Playback Mode

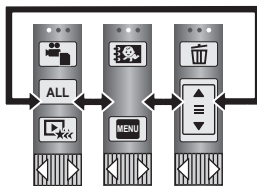

- B** You can change the operation icons to display. (→ 32)
- C** Displayed only in Intelligent Auto Plus Mode (→ 42) and [Miniature Effect]/[8mm movie]/[Silent movie] of the Creative Control Mode (→ 42).
- D** Displayed only in [Time Lapse Rec] of the Creative Control Mode (→ 42), Scene Mode (→ 45), Endless Loop Recording Mode (→ 46) and Manual Mode (→ 47).

## ■ To display the Touch Menu



Display of the Touch Menu will disappear when no touch operation is performed for a specific period of time during recording of motion picture/still picture. To display it again, touch .

- Do not touch on the LCD monitor with hard pointed tips, such as ball point pens.

# Setting date and time

The clock is not set at the time of purchase. Make sure to set the clock.

- **When you turn on this unit, the message “Set home region and date/time.” may be displayed. Select [YES], and follow the steps below to make these settings:**
  - Step 3 of [SET WORLD TIME] (→ 28)
  - Steps 2–3 of “Setting date and time”

## 1 Select the menu. (→ 27)

**MENU** : [SETUP] → [CLOCK SET]

## 2 Touch the date or time to be set, then set the desired value using / .

- **Displaying the World Time setting (→ 28):**

 [HOME] /  [DESTINATION]

- The year can be set between 2000 and 2039.

## 3 Touch [ENTER].

- Touch [EXIT] to complete the setting.

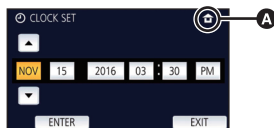

- The date and time function is driven by a built-in lithium battery.
- If the time display becomes [- -], the built-in lithium battery needs to be charged. To recharge the built-in lithium battery, connect the AC adaptor or attach the battery to this unit. The battery is still being recharged even if the unit is off. Leave the unit as it is for approx. 24 hours and the battery will maintain the date and time for approx. 4 months.

# Before recording

## ■ Basic camera positioning

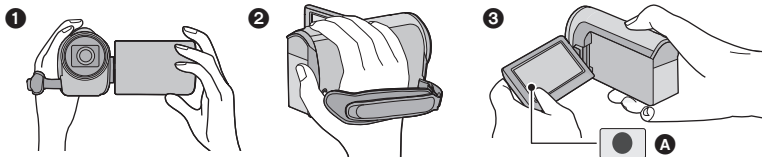

- ① Hold the unit with both hands.
- ② Put your hand through the grip belt.
- ③ It is convenient to use the Recording button icon **A** when holding the unit at waist level.
  - When recording, make sure your footing is stable and there is no danger of colliding with another person or object.
  - When you are outdoors, record pictures with the sunlight behind you. If the subject is backlit, it will become dark in the recording.
  - Keep your arms near your body and separate your legs for better balance.
  - Do not cover the microphones with your hand etc.

## ■ Basic motion picture recording

- The unit should normally be held steady when recording.
- If you move the unit when recording, do so slowly, maintaining a constant speed.
- The zoom operation is useful for recording subjects you cannot get close to, but overuse of zoom in and zoom out can make the resulting motion picture less enjoyable to watch.

## ■ Recording Yourself

**Rotate the LCD monitor towards the lens side.**

- The image is horizontally flipped as if you see a mirror image. (However the image recorded is the same as a normal recording.)
- Only some indications will appear on the screen. When  appears, return the direction of the LCD monitor to normal position and check the warning/alarm indication. (→ 122)

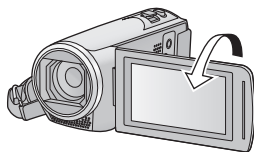



# Recording motion pictures

- Open the lens cover before turning on the unit. (→ 6)

**1** Open the LCD monitor, and set this unit to Motion Picture Recording Mode. (→ 15)

**2** Press the recording start/stop button to start recording.

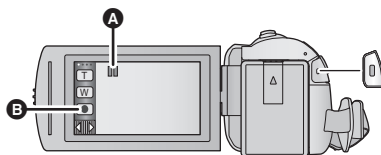

- A** When you begin recording, **II** changes to **●**.
- B** Recording button icon

**3** Press the recording start/stop button again to pause recording.

- Recording can also be started/stopped by touching the recording button icon.

## ■ Screen indications in the Motion Picture Recording Mode

HG1080	Recording mode
R 1h20m	Approximate remaining recordable time <ul style="list-style-type: none"> <li>• When the remaining time is less than 1 minute, R 0h00m flashes red.</li> </ul>
0h00m00s	Recording time elapsed <ul style="list-style-type: none"> <li>• "h" is an abbreviation for hour, "m" for minute and "s" for second.</li> <li>• Each time the unit is put into recording pause, the counter display will be reset to 0h00m00s.</li> </ul>



- Screen display will disappear when no touch operation is performed for a specific period of time. To display it again, touch the screen. (→ 28)
- It will be constantly displayed when the remaining recordable time becomes less than 30 minutes.

- **If the recording/playback button is pressed during motion picture recording, the recording will stop and this unit will be switched to Playback Mode.**
- **To change the recording format, change the [REC FORMAT] or [REC MODE]. (→ 61, 62)**
- **Still pictures can be recorded while recording the motion picture. (→ 23)**
- The images recorded between pressing the recording start/stop button to start recording and pressing it again to pause recording become one scene. When you record with the [REC FORMAT] set to [MP4/iFrame], the scenes longer than approximately 20 minutes will be automatically divided. (Recording will continue.)

- (Maximum recordable scenes of a single SD card)

Recording format	[AVCHD]	[MP4/iFrame]
Recordable scenes	Approx. 3900	Approx. 89100
Different dates (→ 72)	Approx. 900	Approx. 900

- Maximum number of recordable scenes and maximum number of different dates will be less than above table when there are both MP4/iFrame scenes and still pictures recorded on an SD card.
- While recording is in progress, the recording will not stop even if the LCD monitor is closed.
- Please refer to page 133 for details about approximate recordable time.
- The maximum remaining recordable time that can be displayed for motion picture recording is 99 hours and 59 minutes. Any remaining recordable time exceeding 99 hours and 59 minutes will be displayed as "R99h59m+". This display remains unchanged until the remaining recordable time drops to 99 hours and 59 minutes or less.

Basic



## Recording still pictures

- Open the lens cover before turning on the unit. (→ 6)

**1** Open the LCD monitor, and set this unit to Still Picture Recording Mode. (→ 15)

**2** Press the  button halfway. (For Auto Focus only)

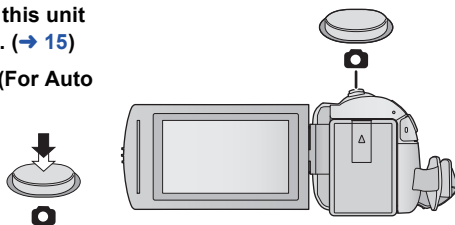

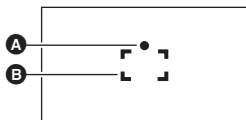

**Focus indication:**







- A** Focus indication:
  - (The white lamp flashes.): Focusing
  - (The green lamp lights up.): When in focus
  - No mark: When focusing is unsuccessful.
- B** Focus area (area inside brackets)

**3** Press the  button fully.



- If you set the Optical Image Stabilizer function (→ 52) to  (MODE1), then the Image Stabilizer function will be more effective. ( (MEGA Optical Image Stabilizer) will be displayed when the  button is pressed halfway.)
- Using a tripod is recommended when recording still pictures in dark places because the shutter speed becomes slow.
- You can also take a picture just by touching the subject to focus. (Touch Shutter: → 55)
- The still picture recording time may be long depending on the picture size.
- The focus indication and the focus area may not be displayed depending on the recording conditions or the menu settings.

## ■ About the screen indications in Still Picture Recording Mode

	Still picture operation indicator (→ 119)
R3000	Remaining number of still pictures <ul style="list-style-type: none"> <li>• Flashes in red when [0] appears.</li> </ul>
	Size of still pictures (→ 67)
	MEGA Optical Image Stabilizer (→ 22)
	Optical Image Stabilizer (→ 52)

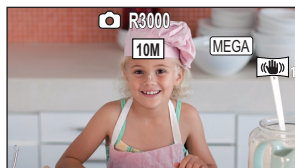

- Screen display will disappear when no touch operation is performed for a specific period of time. To display it again, touch the screen.
- It will be constantly displayed when the remaining number of still pictures that can be recorded becomes 200 or less.

## ■ About the focusing area

When there is a contrasting object ahead or behind the subject in the focus area, the subject may not be focused. If so, move the contrasting object out of the focus area.

# Recording still pictures in Motion Picture Recording Mode

---



◇ Set this unit to Motion Picture Recording Mode (→ 15)

**Press the  button fully (press to the bottom) to take the picture.**

- It is possible to record still pictures while recording motion pictures.  
(Simultaneous recording)
- While still pictures are being recorded,  turns red and the remaining number of recordable pictures is displayed.
- No shutter sound is emitted when recording still pictures.



- 
- Self-timer (→ 58) does not work.
  - While recording motion pictures or during the PRE-REC operation, image quality is different from ordinary still pictures so that motion picture recording takes preference over still picture recording.
  - If simultaneous recording is performed during motion picture recording, the remaining recordable time will be shortened. If this unit is turned off or the recording/playback button is pressed, the remaining recordable time may be lengthened.
  - The still picture recording time may be long depending on the picture size.
  - Maximum number of recordable pictures that can be displayed is 9999. If the number of recordable pictures exceeds 9999, R 9999+ is displayed. The number will not change when the picture is taken until the number of recordable pictures is 9999 or less.
  - The recording time may be long depending on the recording condition.

# Motion picture/Still picture playback



**1** Set this unit to Playback Mode (→ 15).

**2** Touch the play mode select icon **A** (→ 17).

- You can also set by touching **MENU**, selecting [VIDEO SETUP] or [PICT. SETUP] → [MEDIA, VIDEO/PICTURE]. (→ 27)

**3** Select the still picture **C** or the recording format of the motion picture **D** you wish to play back.

- Touch [Enter].

**4** (When [AVCHD] or [MP4/iFrame] is touched)

**Touch the desired recording format for playback.**

- When [AVCHD] is selected

[ALL AVCHD]/[1080/60p]/[1080/60i]

- When [MP4/iFrame] is selected

[ALL MP4/iFrame]/[1080/60p]/[720/30p]/[360/30p]/[iFrame]

- The recording mode icon **B** is displayed in the thumbnail display when the item is touched. (AVCHD, 1080/60p, 1080/60i, MP4/iFrame, 1080, 720, 360 and iFrame)
- The following icons are displayed on thumbnails when [ALL AVCHD] or [1080/60i] is touched:
  - AVCHD [1080/60p] scene: 60p
  - AVCHD [PH] scene: PH
  - AVCHD [HA] scene: HA
  - AVCHD [HG] scene: HG
  - AVCHD [HE] scene: HE
- The following icons are displayed on thumbnails when [ALL MP4/iFrame] is touched:
  - MP4 [1080/60p] scene: 1080
  - MP4 [720/30p] scene: 720
  - MP4 [360/30p] scene: 360
  - iFrame scene: iFrame

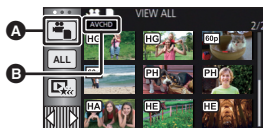



## 5 Touch the scene or the still picture to be played back.

- To display the next (previous) page:
  - Slide the thumbnail display upward (downward) while touching it.
  - Switch the Touch Menu, and then touch ▲ (up) / ▼ (down) on the thumbnail scroll lever.



## 6 Select the playback operation by touching the operation icon.

- Operation icons and screen display will disappear when no touch operation is performed for a specific period of time. To display them again, touch the screen.



Operation icon

Motion picture playback	Still picture playback
▶/  : Playback/Pause	▶/  : Slide show (playback of the still pictures in numerical order) start/pause.
◀◀: Fast rewind playback*	◀  : Plays back the previous picture.
▶▶: Fast forward playback*	▶: Plays back the next picture.
■: Stops the playback and shows the thumbnails.	■: Stops the playback and shows the thumbnails.

\* When touched two times, the fast rewind/fast forward speed increases. (The screen display changes to ◀◀ / ▶▶ .)

## Change the thumbnail display

While the thumbnail is displayed, the thumbnail display changes in the following order if the zoom lever is operated to Q side or side. 20 scenes ↔ 9 scenes ↔ 1 scene ↔ Highlight & Time Frame Index\* (→ 70)

\* Highlight & Time Frame Index can only set in Motion Picture Playback Mode.

- If the recording/playback button is pressed, the thumbnail display will return to the one that displays 9 scenes.
- By displaying in 1 scene or touching and holding the thumbnail in the 20 scenes or 9 scenes display, recording date and time are displayed when playing back motion pictures, and recording date and file number when playing back still pictures.



## ■ Speaker volume adjustment

Operate the volume lever to adjust the speaker volume during Motion Picture Playback Mode.

**Towards “+”:** Increases the volume

**Towards “-”:** Decreases the volume

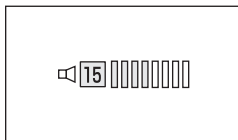

- Sound will be heard only during normal playback.
- If pause play is continued for approx. 5 minutes, the screen returns to the thumbnails.
- The elapsed time for playback indication will be reset to 0h00m00s each scene.
- When played back with [ALL AVCHD] or [ALL MP4/iFrame] selected, the screen may become black momentarily at the time the scene switches.

## Motion picture compatibility

- This unit is based on AVCHD Progressive/AVCHD format/MPEG-4 AVC file format.
- Even if the devices used have compatible standards, when playback of motion pictures recorded using another device is performed using this unit, or when motion pictures recorded using this unit is played back in another device, playback may not proceed normally, or may not be possible. (Please check compatibility in the operating instruction of your device.)
- Motion pictures recorded with other devices are not supported by this unit.

## Still picture compatibility

- This unit is compliant with the unified standard DCF (Design rule for Camera File system) established by JEITA (Japan Electronics and Information Technology Industries Association).
- This unit may degrade or not play back still pictures recorded or created on other products and other products may degrade or not play back still pictures recorded on this unit.
- Depending on the playback device, still pictures may be played back with picture sizes different from the ones with which they were recorded.

# Using the menu screen

- Touch ◀ (left side)/ ▶ (right side) of  on the Touch Menu to display . (→ 17)

## 1 Touch .



## ■ About guide display

After touching , touching the submenu and items will cause function descriptions and settings confirmation messages to appear.

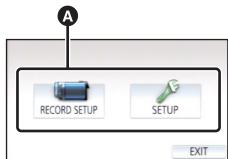

- After the messages have been displayed, the guide display is canceled.

## 2 Touch the top menu .

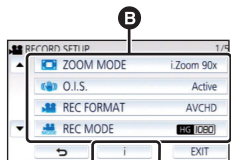

## 3 Touch the submenu .



- Next (previous) page is displayed by touching  / .

## 4 Touch the desired item to enter the setting.

## 5 Touch [EXIT] to exit the menu setting.

# Using the Setup Menu

## [DISPLAY]



Set the display method for the screen information display.

**[MENU] : [SETUP] → [DISPLAY] → desired setting**

**[5 SEC.]:** Information is displayed on the screen for 5 seconds after starting the Motion Picture Recording Mode or Still Picture Recording Mode, starting to playback, or touching the screen.

**[ON]:** Constantly displayed.

## [CLOCK SET]



Please refer to page 18.

## [SET WORLD TIME]



It is possible to display and record the time at the travel destination by selecting your home region and the travel destination.

### 1 Select the menu.

**[MENU] : [SETUP] → [SET WORLD TIME]**

- When the [HOME] (your home region) is not set, the message appears. Touch [ENTER] and proceed to Step 3.

### 2 (Only when setting your home region)

**Touch [HOME].**

- Touch [ENTER].

### 3 (Only when setting your home region)

**Touch [◀] / [▶] to select your home region and touch [ENTER].**

- Touch [DAYLIGHT SAVING] to set daylight saving time. is displayed and the summer time setting is turned on, the time difference between the current time and GMT will be set forward by 1 hour. Touch [DAYLIGHT SAVING] again to return to the normal time setting.

If you set [Link Clock to Daylight Saving] to [ON], the current time will also be set forward by 1 hour. (→ 29)

### 4 (Only when setting the region of your travel destination)

**Touch [DESTINATION].**

- Touch [ENTER].



- A** The current time
- B** The time difference from GMT (Greenwich Mean Time)

- When the home region is set for the first time, the screen for selecting home/travel destination appears after setting the home region successively. If the home region has already been set once, execute the menu operation for Step 1.
- 5 (Only when setting the region of your travel destination)
- Touch ◀/▶ to select your travel destination and touch [ENTER].
- Touch [DAYLIGHT SAVING] to set daylight saving time. ⚙️🕒 is displayed and the summer time setting is turned on, the time difference between the travel destination and the home region will be set forward by 1 hour. Touch [DAYLIGHT SAVING] again to return to the normal time setting. If you set [Link Clock to Daylight Saving] to [ON], the time at the travel destination will also be set forward by 1 hour.
  - Close the setting by touching [EXIT]. ✈️ appears and the time of the travel destination is indicated.



- C The local time at the selected travel destination
- D The time difference between the travel destination and the home region

### To return the display to the home setting

Set the home region using Steps 1 to 3, and close the setting by touching [EXIT].

- If you cannot find your travel destination in the area shown on the screen, set it by using the time difference from your home region.

### [Link Clock to Daylight Saving]



If you set this function to [ON] and turn on the summer time setting in [SET WORLD TIME], the following times will be set forward by 1 hour:

- When setting your home region: the current time
- When setting the region of your travel destination: the time at the travel destination

**MENU** : [SETUP] → [Link Clock to Daylight Saving] → desired display

**[ON]:** The times are adjusted when the summer time setting is turned on.

**[OFF]:** The times are not adjusted when the summer time setting is turned on.

## [DATE/TIME]



It is possible to change the date and time display mode.

**MENU** : [SETUP] → [DATE/TIME] → desired display

### [DATE]/[D/T]/[OFF]

- The date and time are not displayed while the recording mode switching icon is displayed. (→ 15)
- When the Touch Shutter is enabled, the recording mode switching icon is constantly displayed. This causes the date and time to disappear from the screen.

## [DATE FORMAT]



It is possible to change the date format.

**MENU** : [SETUP] → [DATE FORMAT] → desired setting

### [Y/M/D]/[M/D/Y]/[D/M/Y]

## [ZOOM/REC DISPLAY]



You can set the display method of the zoom button icons (  T /  W ) and recording button icon (  ).

**MENU** : [SETUP] → [ZOOM/REC DISPLAY] → desired setting

**[ON]:** Constantly displayed.

**[OFF]:** Icons will disappear after approx. 5 seconds without any touch operation.

## [O.I.S. LOCK DISPLAY]



Please refer to page 54.

## [EXT. DISPLAY]



Please refer to page 92.

## [ECONOMY (BATT)]



When about 5 minutes have passed without any operation, this unit automatically turns off to save battery life.

**MENU** : [SETUP] → [ECONOMY (BATT)] → [ON]

- This unit will not automatically turn off even if [ECONOMY (BATT)] is set to [ON] in following cases:
  - Using the AC adaptor\*
  - Using the USB cable for PC etc.
  - PRE-REC is used
  - During slide show playback
- \* When [ECONOMY (AC)] is activated, this unit automatically turns off.

## [ECONOMY (AC)]



When about 15 minutes have passed without any operation while connecting AC adaptor with this unit, this unit automatically turns off.

**MENU** : [SETUP] → [ECONOMY (AC)] → [ON]

- This unit will not automatically turn off even if [ECONOMY (AC)] is set to [ON] in following cases:
  - Using the USB cable for PC etc.
  - PRE-REC is used
  - During slide show playback

## [ALERT SOUND]



Touch screen operation, starting and stopping of recording and unit on/off can be confirmed with this sound.

When [OFF] is selected, the sound is not output at the start/end of recording, etc.

**MENU** : [SETUP] → [ALERT SOUND] → desired setting

(Volume low)/ (Volume high)/[OFF]

### 2 Beeps for 4 times

When an error occurs. Check the sentence displayed on the screen. (→ 122)

- Refer to page 67 when changing the shutter sound setting.

## [SELECT OPERATION ICONS]



You can change the operation icons (→ 56) to display in the Touch Menu.

Register 3 favorite operation icons.

- The default settings are, (Fade), (PRE-REC) and (Backlight Compensation) for Motion Picture Recording Mode, and (Self-timer), (Backlight Compensation) and (Tele Macro) for Still Picture Recording Mode.

### 1 Select the menu.

**MENU** : [SETUP] → [SELECT OPERATION ICONS]

### 2 Touch the operation icon you would like to change to cancel the setting.

### 3 Touch the operation icon to be set.

- Name of the function is displayed by touching and holding on the operation icon.
- To cancel, touch the operation icon again.

### 4 Touch [ENTER].

## [POWER LCD]



This makes it easier to view the LCD monitor in bright places including outdoors.

**MENU** : [SETUP] → [POWER LCD] → desired setting

\* (Makes brighter) / \* (Normal) / \* (Makes less bright)

- These settings will not affect the images actually recorded.
- When the AC adaptor is in use, the LCD monitor is set to \* automatically.
- Recordable time with the battery is shortened when the LCD is made brighter.

## [LCD SET]



It adjusts brightness and color density on the LCD monitor.

- These settings will not affect the images actually recorded.

### 1 Select the menu.

**MENU** : [SETUP] → [LCD SET] → desired setting

**[BRIGHTNESS]:** Brightness of the LCD monitor

**[COLOR]:** Color level of the LCD monitor

### 2 Touch / to adjust settings.

### 3 Touch [ENTER].

- Touch [EXIT] to exit the menu screen.



## [HDMI RESOLUTION]



Please refer to page 92.

## [VIERA Link]



Please refer to page 93.

## [TV ASPECT]



Please refer to page 92.

## [INITIAL SET]



Set to [YES] for changing the menu settings back to the default condition.

**MENU** : [SETUP] → [INITIAL SET]

- Settings for [CLOCK SET] and [LANGUAGE] will not be changed.
- If you restore the default settings, this unit will switch to the Motion Picture Recording Mode.

## [Auto Cursor Position]



The entered character is confirmed in approx. 1 second after character input, and the cursor is moved to the right.

It makes the input easy without moving the cursor when characters on the same key are to be entered again.

**MENU** : [SETUP] → [Auto Cursor Position] → [ON]

- Character input screen is displayed in following conditions:
  - When setting [TITLE SETUP] for the Highlight Playback (→ 77)
  - When entering a name in the Baby Calendar (→ 82)

## [NUMBER RESET]



Set the file number of the MP4/iFrame and still picture recorded next to 0001.

**MENU** : [SETUP] → [NUMBER RESET]

- Folder number is updated and file number will start from 0001. (→ 116)
- To reset the folder number, format the SD card, and then perform [NUMBER RESET].

## [FORMAT MEDIA]



Please be aware that if a medium is formatted, then all the data recorded on the medium will be erased and cannot be restored. Back up important data on a PC, DVD disc etc. (→ 107)

**MENU** : [SETUP] → [FORMAT MEDIA] → **desired media**

### [SD CARD]/[HDD]\*

- \* Displayed when connecting a USB HDD. (→ 95)
  - Media selection screen is not displayed when the USB HDD is not connected. Touch [YES].
  - When formatting is complete, touch [EXIT] to exit the message screen.
  - Perform a physical formatting of the SD card when the SD card is to be disposed/ transferred. (→ 130)
- 
- Do not turn this unit off or remove the SD card, while formatting. Do not expose the unit to vibrations or shock.

**Use this unit to format media.**

**Do not format an SD card using any other equipment such as a PC. The card may not be used on this unit.**

## [MEDIA STATUS]



The used space and remaining recordable time of the SD card can be checked.

**MENU** : [SETUP] → [MEDIA STATUS]

- The remaining recordable time in the currently set Recording Mode is displayed only in the Motion Picture Recording Mode.
  - Any remaining recordable time exceeding 99 hours and 59 minutes will be displayed as "99h59m+".
  - Touch [EXIT] to close the indication.
- 
- The SD card requires some space to store information and manage system files, so the actual usable space is slightly less than the indicated value. The usable SD card space is generally calculated as 1 GB=1,000,000,000 bytes. The capacities of this unit, PCs and software are expressed as 1 GB=1,024×1,024×1,024=1,073,741,824 bytes. Therefore, the indicated value of the capacity appears to be smaller.

## [Firmware Version Info]



The firmware version of this unit is displayed.

**MENU** : [SETUP] → [Firmware Version Info]

## [Firmware Upgrade]



You can update the firmware version of this unit.

**MENU** : [SETUP] → [Firmware Upgrade]

**For the latest update information, check the support website below. (As of November 2015)**

[http://panasonic.jp/support/global/cs/e\\_cam](http://panasonic.jp/support/global/cs/e_cam)  
(This Site is English only)

## [DEMO MODE]



This item is used to start the unit demonstration.

**MENU** : [SETUP] → [DEMO MODE] → [ON]

- If [DEMO MODE] is switched to [ON] and you touch [EXIT] when there is no SD card inserted and while this unit is connected to the AC adaptor, the demonstration automatically starts. If any operation takes place, the demonstration is canceled. However if no operations take place for approx. 10 minutes, the demonstration automatically starts again. To stop the demonstration, set [DEMO MODE] to [OFF] or insert an SD card.

## [O.I.S. DEMO]



This item is used to start the Optical Image Stabilizer demo.

**MENU** : [SETUP] → [O.I.S. DEMO]

- Touch [O.I.S. DEMO], the demonstration automatically starts. When you touch [EXIT], the demonstration will be canceled.

## [Eye-Fi TRANSFER]



This item is displayed only when an Eye-Fi card is inserted.  
Please refer to page 104.

## [Eye-Fi DIRECT]



This item is displayed only when an Eye-Fi card is inserted.  
Please refer to page 105.

## [SOFTWARE INFO]



You can connect this unit and a PC with the USB cable and check software information (License) on the PC.

### 1 Select the menu.

**MENU** : [SETUP] → [SOFTWARE INFO]

### 2 Connect this unit to a PC.

- A message will be displayed when the connection is complete. On the PC, check [LICENSE.TXT].
- When using the battery, the LCD monitor turns off after about 5 seconds. Touch the screen to turn the LCD monitor on.

- Do not use any other USB cables except the supplied one. (Operation is not guaranteed with any other USB cables.)

## [Approved Regulations]



Display the authentication information for this unit.

**MENU** : [SETUP] → [Approved Regulations]

- The authentication information cannot be displayed on external devices. Check it on the LCD monitor of this unit.

## [ONLINE MANUAL]



You can check how to access the website where you can download the Owner's Manual (PDF format).

**MENU** : [SETUP] → [ONLINE MANUAL] → **desired access method**

<b>[URL display]:</b>	Displays the URL of the website on the LCD monitor of this unit.
<b>[USB connect]:</b>	Displays the website on a PC connected to this unit with the USB cable.
<b>[QR code]:</b>	Displays the QR code of the website on the LCD monitor of this unit.

## [LANGUAGE]



You can select the language on the screen display and the menu screen.

**MENU** : [SETUP] → [LANGUAGE] → **desired language**

# Using the zoom

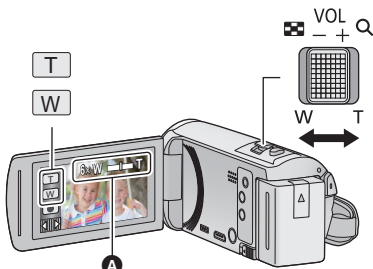

## Zoom lever/Zoom button icons

### T side:

Close-up recording (zoom in)

### W side:

Wide-angle recording (zoom out)

### A Zoom bar

- Maximum zoom ratio for recording motion pictures can be set with [ZOOM MODE]. (→ 61)

### ■ About the zoom bar

The zoom bar is displayed during the zoom operation.

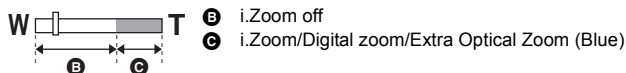

### ■ About the zoom speed

- The zoom speed varies depending on the range over which the zoom lever is moved.
- The zoom operation using the zoom button icons will be performed at a constant speed respectively.

## Zoom ratio during the Still Picture Recording Mode



The zoom ratio can be expanded up to 100× without degrading the picture quality for the Still Picture Recording Mode. (Extra Optical Zoom)

- Maximum zoom ratio in Still Picture Recording Mode varies depending on the setting of [PICTURE SIZE]. (→ 67)

- If you take your finger off the zoom lever during zoom operation, the operation sound may be recorded. When returning the zoom lever to the original position, move it quietly.
- When the zoom magnification is at its maximum, the subjects are focused at about 2.2 m (7.2 feet) or more.
- When the zoom magnification is 1×, this unit can focus on a subject approx. 2 cm (0.8 ") away from the lens.



# Level Shot Function

This function detects the horizontal tilt of the unit, and automatically corrects it to the level position.

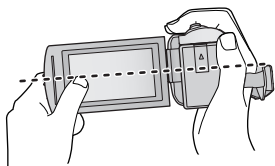

(When setting (Normal)) (When setting s (Strong))



————— : With Level Shot Function  
 - - - - - : Without Level Shot Function

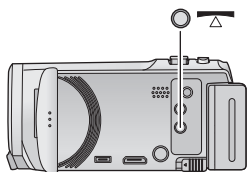

## Level Shot Function button

Each press of this button switches Level Shot Function.

(Normal) → s (Strong) → Off

(Normal): Corrects the tilt.

s (Strong): Strengthen tilt correction.

Off: Cancel the setting.

- The icon changes when the tilt exceeds the correction range.

/  s	When the tilt is corrected
/  s /  /  s	When the tilt is above the correction range

- When the tilt exceeds the correction range, move the unit to the position where / s is displayed.
- 
- This function's default setting is (Normal).
  - The range that this icon can be displayed correctly the slope is about 45° to the horizontal direction.
  - Level Shot Function is canceled when [LEVEL GAUGE] is set to [ON]. (→ 63)
  - When recording horizontal images using a tripod, attach the unit on the tripod using [LEVEL GAUGE] (→ 63), and then set Level Shot Function to (Normal) or s (Strong) before use.
  - When you switch the setting of the Level Shot Function, the screen may become black momentarily.
  - If you set the option to (Normal) / s (Strong), the angle of view will change.
  - This function cannot be set when recording a motion picture or during PRE-REC.







# Changing the Recording Mode

**1** Touch the Recording Mode button icon.



**2** Touch the desired Recording Mode button icon.



Mode		Effect
 *1  *2	<b>Intelligent Auto</b>	You can switch the mode to the Intelligent Auto Mode, which optimizes settings to the recording environment you are in. (→ 40)
 *1  *2	<b>Intelligent Auto Plus</b>	You can add manually-adjusted brightness and color balance settings to the Intelligent Auto Mode, and record. (→ 42)
 *1	<b>Creative Control</b>	You can record motion pictures with added effects. (→ 42)
<b>SCN</b>	<b>Scene Mode</b>	This option allows this unit to automatically adjust the shutter speed and aperture, etc. according to the scene you want to record. (→ 45)
	<b>Manual</b>	You can set the shutter speed, focus, White Balance and brightness (iris/gain). (→ 47)
 *1	<b>Endless Loop Recording</b>	No matter how long you record, you can only record scenes for the last 1 hour to SD card. (→ 46)

\*1 In Motion Picture Recording Mode only

\*2 In Still Picture Recording Mode only



The following modes (appropriate for the condition) are set just by pointing the unit to what you want to record.

Mode	Effect
<b>Portrait</b>	Faces are detected and focused automatically, and the brightness is adjusted so it is recorded clearly.
<b>Scenery</b>	The whole landscape will be recorded vividly without whitening out the background sky, which may be very bright.
<sup>*1</sup> <b>Spotlight</b>	Very bright object is recorded clearly.
<sup>*1</sup> <b>Low Light</b>	It can record very clearly even in a dark room or twilight.
<sup>*2</sup> <b>Night Scenery</b>	You can record night scenery vividly by slowing the shutter speed.
<sup>*2</sup> <b>Macro</b>	This allows recording at very close proximity to the object of recording.
<sup>*1</sup> <b>Normal</b>	In modes other than those described above, the contrast is adjusted to give a clear picture.
<sup>*2</sup> <b>Normal</b>	

\*1 In Motion Picture Recording Mode only

\*2 In Still Picture Recording Mode only

- Depending on the recording conditions, the unit may not enter the desired mode.
- In the Portrait, Spotlight, or Low Light Mode, the face will be surrounded by a white frame when detected. In the Portrait Mode, a subject that is bigger and close to center of the screen will be surrounded by an orange frame. (→ 62)
- Using a tripod is recommended in Night Scenery Mode.
- Faces cannot be detected depending on the recording conditions, such as when faces are of certain sizes or at certain tilts or when digital zoom is used.



## ■ Intelligent Auto Mode

When switching to Intelligent Auto Mode, the Automatic White Balance and Auto Focus operate and automatically adjust the color balance and focusing.

Depending on the brightness of the subject etc., the aperture and shutter speed are automatically adjusted for an optimum brightness.

- Color balance and focus may not be adjusted automatically depending on light sources or scenes. If so, manually adjust these settings. (→ 48, 50)

### Automatic White Balance

The illustration shows the range over which Automatic White Balance functions.

- 1) The effective range of Automatic White Balance adjustment on this unit
- 2) Blue sky
- 3) Cloudy sky (rain)
- 4) Sunlight
- 5) White fluorescent lamp
- 6) Halogen light bulb
- 7) Incandescent light bulb
- 8) Sunrise or sunset
- 9) Candlelight

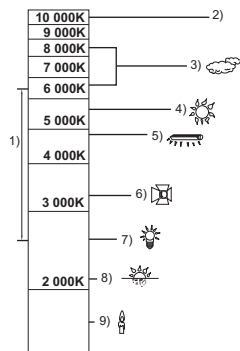

If the Automatic White Balance is not functioning normally, adjust the White Balance manually. (→ 48)

### Auto Focus

The unit focuses automatically.

- Auto Focus does not work correctly in the following situations.
  - Record pictures in the Manual Focus Mode. (→ 50)
  - Recording distant and close-up objects at the same time
  - Recording a subject behind dirty or dusty window
  - Recording a subject that is surrounded by objects with glossy surfaces or by highly reflective objects



Please refer to page 40 for details about the effect of each mode.

(Portrait) / (Scenery) / (Spotlight)<sup>\*1</sup> / (Low Light)<sup>\*1</sup> / (Night Scenery)<sup>\*2</sup> / (Macro)<sup>\*2</sup> / (Normal)<sup>\*1</sup> / (Normal)<sup>\*2</sup>

\*1 In Motion Picture Recording Mode only

\*2 In Still Picture Recording Mode only

## ● Change the Recording Mode to / . (→ 39)

1 (When adjusting the brightness)

Touch .

(When adjusting the color balance)

Touch .

● R side: Sets the balance to a reddish tone.

B side: Sets the balance to a bluish tone.

● Except for when adjusting the brightness or color balance, if you do not touch the screen for a while, the Touch Menu will disappear. To display it again, touch .

## 2 Touch / to adjust settings.

● Touch while adjusting the brightness, or touch while adjusting the color balance to make the display of the adjustment bar disappear.

## 3 Start recording.

## Creative Control





● Set [REC FORMAT] to [AVCHD]. (→ 61)

● Change the Recording Mode to . (→ 39)

Select the desired Creative Control Mode, then touch [Enter].

Mode	Effect
[Miniature Effect]	You can record motion pictures with a diorama effect like recording a miniature by intentionally creating focused area and out of focused area in the peripheral of the image and recording motion picture with an interval. (→ 43) ● Motion pictures recorded with this function will look as if the frame rate is low.
[8mm movie]	You can record motion pictures with a faded retro effect. (→ 44)
[Silent movie]	You can record motion pictures that are similar to black-and-white silent films by lowering the amount of incoming light. (→ 44)
[Time Lapse Rec]	You can record a scene that moves slowly over a long period of time as a short time motion picture by recording one frame at each set time lapse. (→ 44)

● Still pictures cannot be taken.

**1 Touch   to adjust the horizontal position of the in-focus portion.**

- If you touch the screen, you can adjust the horizontal position of the in-focus portion.
- When no touch operations are performed for approximately 1 second, [Reset], [SIZE], and [ENTER] are displayed. If you touch the screen, you can readjust the horizontal position of the in-focus portion.
- Position of the in-focus portion will return to original position when you touch [Reset].



**2 Touch [SIZE].**



- The size of the in-focus portion is switched every time you touch [SIZE].  
**Medium size → Large size → Small size**
- If you touch the screen, you can adjust the horizontal position of the in-focus portion.
- If you touch [Reset], the in-focus portion is reset to the original position and [SIZE] is reset to the medium size.

**3 Touch [ENTER].**

4 (When adjusting the brightness)

**Touch .**

- The level of brightness is switched every time you touch the icon.

0 (Standard) → +1 (Bright) → -1 (Dark)

5 (When adjusting the vividness)

**Touch .**

- The level of vividness is switched every time you touch the icon.

0 (Standard) → +1 (Vivid) → +2 (Most vivid)

**6 Start recording.**

- It will record with an interval. 1 second will be recorded for approximately every 6 seconds of recording.



- To make the Miniature Effect easier to gain, record objects incorporating a distant view or those that can provide depth or a skewed perspective. Also, use a tripod and avoid zooming.
- You may see a lot of noise in the in-focus portion when recording dark subjects such as night scenes.
- Audio cannot be recorded.
- [REC MODE] is set to [HA].
- The maximum recordable time is 12 hours.
- Motion pictures recorded with this function will look as if the frame rate is low.

## 8mm [8mm movie]

1 (When adjusting the brightness)

Touch .

- The level of brightness is switched every time you touch the icon.

0 (Standard) → <sub>+1</sub> (Bright) → <sub>-1</sub> (Dark)

2 (When adjusting the color balance)

Touch .

- The level of color balance is switched every time you touch the icon.

B (Blue) → R (Red) → Y (Yellow)

3 Start recording.



- 
- The sound is monaural.

## SILN [Silent movie]

1 (When adjusting the brightness)

Touch .

- The level of brightness is switched every time you touch the icon.

0 (Standard) → <sub>+1</sub> (Bright) → <sub>-1</sub> (Dark)

2 Start recording.

- 
- Audio cannot be recorded.

## INTV [Time Lapse Rec]

Touch the desired setup time.

[1 SEC.]/[10 SEC.]/[30 SEC.]/[1 MINUTE]/[2 MINUTES]

- Touch [ENTER].
- A frame is recorded with a set recording interval. 30 frames will make up motion picture of 1 second.

Setup example	Setup time (recording interval)	Recording time	Recorded time
Sunset	1 s	1 h	2 min
Blooming	30 s	3 h	12 s

- "h" is an abbreviation for hour, "min" for minute and "s" for second.
- These times are approximations.
- Maximum recordable time is 12 hours.

- 
- Audio cannot be recorded.
  - [REC MODE] is set to [HA].
  - The shortest motion picture recording time is 1 second.
  - The color balance and focus may not be adjusted automatically depending on the light source or scene. If so, manually adjust those settings. (→ 48, 50)
  - When recording for a long time, we recommend recording with the AC adaptor connected.



- Change the Recording Mode to SCN . (→ 39)  
Select the desired Scene Mode, then touch [ENTER].

Mode	Effect
<b>Sports:</b>	To make fast moving scenes less shaky with slow playback and pause of playback
<b>Portrait:</b>	To make people stand out against the background
<b>Soft Skin:</b>	To makes skin colors appear softer for a more attractive appearance
<b>Spotlight:</b>	Improved quality when subject is brightly illuminated.
<b>Snow:</b>	Improved image quality when shooting in snowy locations.
<b>Beach:</b>	To make blue in the sea or sky vibrant
<b>Sunset:</b>	To make red in the sunrise or sunset vibrant
<b>Scenery:</b>	For spatial scenery
<b>Fireworks:</b>	To capture the fireworks in the night sky beautifully
<b>Night Scenery:</b>	To capture the evening or night scenery beautifully
<b>Low Light:</b>	For dark scenes, such as at dusk (In Motion Picture Recording Mode only)

- **(Sports/Portrait/Soft Skin/Spotlight/Snow/Beach/Sunset/Scenery)**
  - The shutter speed is 1/8 or more in Still Picture Recording Mode.
- **(Sunset/Low Light)**
  - The shutter speed is 1/30 or more in Motion Picture Recording Mode.
- **(Sunset/Scenery/Fireworks/Night Scenery)**
  - Image may get blurry when close object is recorded.
- **(Sports)**
  - During normal playback, the image movement may not look smooth.
  - Color and screen brightness may change under indoor lighting.
  - If the brightness is insufficient, the Sports Mode does not function. The display flashes.
- **(Portrait)**
  - Color and screen brightness may change under indoor lighting.
- **(Soft Skin)**
  - If the background or anything else in the scene has colors similar to the skin color, they will also be smoothed.
  - If the brightness is insufficient, the effect may not be clear.
  - If you record a person in the distance, the face may not be recorded clearly. In this case, cancel Soft Skin Mode or zoom in on the face (close-up) to record.
- **(Fireworks)**
  - The shutter speed is 1/30.
  - Image may get washed out when recorded in bright surrounding.
- **(Night Scenery)**
  - The shutter speed is 1/2 or more in Still Picture Recording Mode.
  - Using a tripod is recommended.



# Endless Loop Recording



- Insert an SD card.
- Change the Recording Mode to . (→ 39)

## 1 Select sound in loop recording setting.

[ON]:	Records sound.
[OFF]:	Recording of sound is off.

## 2 Start recording.

- Once you start recording, the scene will be automatically divided every 2 minutes. The divided scenes will be saved in the SD card. (Each time you use Endless Loop Recording, a set of up to 30 scenes will be saved.)
- When the period between the time you start recording and the time you stop recording is longer than 1 hour (approximate), only the last 1 hour (approximate) part up to the end of the recording will be saved. The part before the 1 hour part will be deleted.
- Recording stops automatically when approximately 24 hours have passed since the start of the recording.
- During recording, the blinks.
- The remaining recordable time and elapsed recording time are not displayed. (→ 20)
- Only when sound in loop recording is set to [ON], (microphone input level meter) is displayed.

### To switch sound in loop recording

The menu can be set to switch to sound in loop recording.

**MENU** : [RECORD SETUP] → [Sound In Loop Recording] → [ON] or [OFF]

- Still pictures cannot be taken.
- [REC FORMAT] is set to [MP4/iFrame], and [REC MODE] is set to [720].
- Image Stabilizer Function is set to (setting canceled) and Level Shot Function is set to off.
- Endless Loop Recording is not possible in the following cases:
  - When the SD card is not inserted
  - When the approximate remaining recordable time on the SD card is less than 1 hour (The time between R 0h00m and R 0h59m flashes red.)
- Since each set of loop-recorded scenes is displayed separately on the date list, it is convenient to play back loop-recorded scenes by date. (→ 72)  
(The date displayed on the date list will be the one on which you started Endless Loop Recording.)





# Manual recording

- The Manual Focus, White Balance, Shutter Speed, Brightness (Iris and Gain) settings are retained when you change between Motion Picture Recording Mode and Still Picture Recording Mode.

Touch the **MNL** to switch to Manual Mode (→ 39), or display the Manual icon (→ 17).



**A** Manual icon

-  Focus (→ 50)
-  White Balance (→ 48)
-  Manual Shutter Speed (→ 49)
-  Iris Adjustment (→ 49)

- 
- Some functions are disabled depending on settings such as the recording mode.

# White Balance



Automatic White Balance function may not reproduce natural colors depending on the scenes or lighting conditions. If so, you can adjust the White Balance manually.

- **Switch to Manual Mode.** (→ 47)

- 1 Touch [WB].
  - 2 Touch ◀/▶ to select White Balance Mode.
- Touch [WB] to select the mode.



Icon	Mode/Recording conditions
	<b>Automatic White Balance adjustment</b>
	<b>Sunny mode:</b> Outdoors, under a clear sky
	<b>Cloudy mode:</b> Outdoors, under cloudy sky
	<b>Indoor mode 1:</b> Incandescent light, video lights like in the studio, etc.
	<b>Indoor mode 2:</b> Color fluorescent lamps, sodium lamps in gymnasiums etc.
	<b>Manual adjustment mode:</b> <ul style="list-style-type: none"><li>● Mercury-vapor lamps, sodium lamps, some fluorescent lights</li><li>● Lights used for wedding receptions at hotels, stage spotlights in theaters</li><li>● Sunrise, sunset, etc.</li></ul>

- To return to auto setting, set to **AWB** or change the Recording Mode to the Intelligent Auto Mode. (→ 39)

## ■ To set the White Balance manually

- 1 Select , fill the screen with a white subject.
  - 2 Touch and set the blinking .
- When the screen turns black instantly and the display stops flashing and then lights constantly, the setting is complete.
  - If the display continues flashing, the White Balance cannot be set. In this case, use other White Balance Modes.



- If you turn on the unit with the lens cover closed, the Auto White Balance will not be performed correctly. Always open the lens cover before turning on the unit.
- When the display flashes, the Manual White Balance previously adjusted is stored. Whenever recording conditions change, re-set the White Balance.
- When setting both the White Balance and the iris/gain, set the White Balance first.
- **AWB** is not displayed on the screen when **AWB** is being set.



# Manual shutter speed/iris adjustment



## Shutter Speed:

Adjust it when recording fast-moving subjects.

## Iris:

Adjust it when the screen is too bright or too dark.

- Switch to Manual Mode. (→ 47)

**1** Touch [SHTR] or [IRIS].

**2** Touch / to adjust settings.

- Touch [SHTR]/[IRIS] to end the adjustment.

: Shutter speed:

1/60 to 1/8000

- If [AUTO SLOW SHTR] is set to [ON], the shutter speed will be set between 1/30 and 1/8000.
- The shutter speed closer to 1/8000 is faster.
- The shutter speed will be set between 1/2 and 1/2000 in Still Picture Recording Mode.

: Iris/Gain value:

CLOSE ↔ (F16 to F2.0) ↔ OPEN ↔ (0dB to 18dB)

- Value closer to CLOSE darken the image.
- Value closer to 18dB brighten the image.
- When the iris value is adjusted to brighter than OPEN, it changes to the gain value.
- To return to auto setting, change the Recording Mode to the Intelligent Auto Mode. (→ 39)

- 
- When setting both the shutter speed and the iris/gain value, set the shutter speed and then set the iris/gain value.

## Manual shutter speed adjustment

- When the shutter speed is set lower than 1/15 in the Still Picture Recording Mode, using a tripod is recommended. The shutter speed will be set to 1/30 when the unit is turned on again.
- You may see a band of light around an object that is shining very bright, or highly reflective.
- During normal playback, image movement may not look smooth.
- If you record an extremely bright object or record under indoor lighting, color and screen brightness may change or a horizontal line may appear on the screen. In this case, record in the Intelligent Auto Mode or set the shutter speed to 1/60 in areas where the power supply frequency is 60 Hz, or 1/100 in areas of 50 Hz.
- Brightness of the image displayed on the LCD monitor may be different from brightness of the image actually recorded during the Still Picture Recording Mode. Confirm the image on the playback screen after recording.

## Manual iris/gain adjustment

- If the gain value is increased, the noise on the screen increases.
- Depending on the zoom magnification, there are iris values that are not displayed.

# Manual Focus adjustment



If auto focusing is difficult due to the conditions, then use Manual Focus.

- Switch to Manual Mode. (→ 47)

- 1 (When MF assist function is used)  
Select the menu.

MENU : [RECORD SETUP] → [MF ASSIST] → [ON]

- Touch  to display the Manual icon.

- 2 Touch [FOCUS].

- 3 Touch [MF] to change to Manual Focus.

- MF appears on the screen.

- 4 Adjust the focus by touching MF / MF .

MF + : To focus on a close subject

MF - : To focus on a faraway subject

The in-focus area is displayed in blue. The normal screen returns approximately 2 seconds after you finish bringing the subject into focus.

- Touch [FOCUS] to end the adjustment.
- When [MF ASSIST] is [OFF], the blue area is not displayed.
- To restore Auto Focus, touch [AF] in Step 3 or change the Recording Mode to the Intelligent Auto Mode. (→ 39)

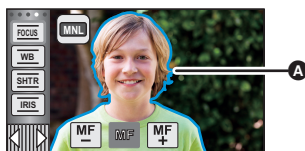

A Part displayed in blue

- The blue display does not appear on the images actually recorded.

# Recording with the Touch Function

You can record using convenient functions just by the easy operation of touching the screen.

**1** Touch ◀ (left side)/ ▶ (right side) of  on the Touch Menu to display Touch Function icons. (→ 17)





**2** Touch the Touch Function icon.

(e.g. AF/AE tracking)

- To cancel, touch the Touch Function icon again. (Optical Image Stabilizer Lock is canceled by releasing the finger touching .)



## Touch function icons

	Image Stabilizer Function
	AF/AE tracking
	Optical Image Stabilizer Lock <sup>*1</sup>
	Touch Shutter <sup>*2</sup>

\*1 In Motion Picture Recording Mode only

\*2 In Still Picture Recording Mode only

Use the Image Stabilizer to reduce the effects of shake during recording.

This unit is equipped with Hybrid Optical Image Stabilizer.

Hybrid Optical Image Stabilizer is a hybrid of Optical and Electrical Image Stabilizer.

Touch to switch the Image Stabilizer on/off.

- The icon at position **A** is switched.



#### (Motion Picture Recording Mode)

/ → (setting canceled)

- When [O.I.S.] is set to [Standard], is displayed; when [O.I.S.] is set to [Active], is displayed.
- When [HYBRID O.I.S.] is set to [ON] and [O.I.S.] is set to [Active], is displayed; When [HYBRID O.I.S.] is set to [ON] and [O.I.S.] is set to [Standard], is displayed.
- When recording with a tripod in Motion Picture Recording Mode, we recommend that you set the Image Stabilizer (off).

#### (Still Picture Recording Mode)

<sub>1</sub> / <sub>2</sub> → (setting canceled)

- When [O.I.S.] is [MODE1], <sub>1</sub> is displayed. When [O.I.S.] is [MODE2], <sub>2</sub> is displayed.

## ■ Changing Image Stabilizer Mode

(Motion Picture Recording Mode)

Setting [HYBRID O.I.S.]

**MENU** : [RECORD SETUP] → [HYBRID O.I.S.] → [ON] or [OFF]

When set to [ON], you can further improve image stabilization for recording while walking, or holding the unit and recording a distant subject with zoom.

- This function's default setting is [ON].

Setting [O.I.S.]

**MENU** : [RECORD SETUP] → [O.I.S.] → [Standard] or [Active]

**[Standard]:** Compensates for blurring caused by hand-shake

**[Active]:** Compensates for even greater blurring caused by hand-shake.

## (Still Picture Recording Mode)

**MENU** : [RECORD SETUP] → [O.I.S.] → [MODE1] or [MODE2]

**[MODE1]:** The function works all the time.

**[MODE2]:** The function works when the  button is pressed. We recommend using this mode when you are recording yourself or recording with a tripod in Still Picture Recording Mode.

## AF/AE tracking





It is possible to set the focus and exposure to the subject specified on the touch screen. The focus and exposure will keep following the subject automatically even if it moves.

### 1 Touch .

- An icon is displayed .

### 2 Touch the object and lock the target.

- When you touch the head of the object, the target frame on the head gets locked and tracking starts.
- Touch the object to be changed again when you want to change the target.
- When the Intelligent Auto Mode or Intelligent Auto Plus Mode is selected, the setting becomes  (Normal) and touched object is tracked. Selection becomes  (Portrait) when target frame is locked on a face. (It may turn to  (Normal) even if the target is locked on the face when a spotlight is shining or with a dark scene.)

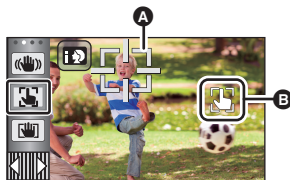

**A** Target frame

### 3 Start recording.

#### ■ About target frame

- When target lock fails, the target frame blinks in red and then disappears. Touch a characteristic part (color etc.) on the object to lock onto it again.
  - When the  button is pressed halfway in Still Picture Recording Mode, the focus is set to the object that is locked. The target frame turns green when it focuses, and the target cannot be changed.
- 
- This function can be used in Intelligent Auto Mode or Intelligent Auto Plus Mode. In Still Picture Recording Mode, this function can only be used with some settings in Scene Mode.
  - It may track different objects or may not lock the target depending on the recording conditions such as the following:
    - When the object is too large or too small
    - When color of the object is similar to the background
    - When the scene is dark
  - When the target is locked in Still Picture Recording Mode, the screen may become dark.
  - If you use the Fade function while the target is locked, the target lock will be canceled. (→ 57)

- AF/AE tracking will be canceled in the following cases.
  - When the unit is turned off
  - Press the recording/playback button
  - Touch the recording mode switching icon
  - Touch the Recording Mode button icon
  - Switch to recording of yourself



## Optical Image Stabilizer Lock



In Motion Picture Recording Mode, you can further improve optical image stabilization by touching and holding . With this function, you can further reduce the effects of the shake that tends to occur when using zoom.

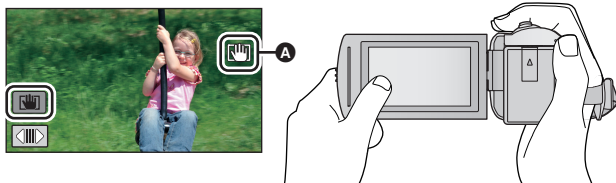



**1** Touch  to turn the Image Stabilizer on. (→ 52)

**2** Touch and hold .

- Icon is displayed in **A** while you are touching and holding .
- Optical Image Stabilizer Lock is released when you remove your finger from the icon.

### ■ To make the display of disappear

Display of  will not disappear even when no operation is performed for specific time with the default setting. To make the display of  disappear, change the setting of the [O.I.S. LOCK DISPLAY].

**MENU** : [SETUP] → [O.I.S. LOCK DISPLAY] → **desired setting**

[ON]: Constantly display.

[OFF]: The icon will disappear after approx. 5 seconds without any touch operation.

- Stabilization may not be possible under strong shaking conditions.
- To record while moving the unit quickly, release Optical Image Stabilizer Lock.



## Touch Shutter



It is possible to focus and record a still picture of a subject that is touched.

**1 Touch**  .

- An icon is displayed **A**.

**2 Touch the subject.**

- Focus area is displayed at the touched position, and a still picture is recorded.



- 
- Depending on the recording conditions or recognition of the touched position, it may not be possible to record the intended picture.
  - This will not operate for recording yourself.

# Recording functions of operation icons

Select the operation icons to add different effects to the images to be recorded.

**1** Touch ◀ (left side)/▶ (right side) of  on the Touch Menu to display the operation icons. (→ 17)





**2** Touch an operation icon.





(e.g. PRE-REC)

- The operation icons that are displayed in the Touch Menu can be changed.  
([SELECT OPERATION ICONS]: → 32)
- Select the operation icon again to cancel the function.  
Refer to the respective pages for canceling the following functions.
  - Self-timer (→ 58)
  - Guidelines (→ 59)
- The icon is displayed when the operation icon is set.



## Operation icons

	Fade <sup>*1</sup>
	Intelligent Contrast Control <sup>*1</sup>
	PRE-REC <sup>*1</sup>
	Self-timer <sup>*2</sup>

	Intelligent Exposure <sup>*2</sup>
	Backlight Compensation
	Tele Macro
	Guidelines
	Night Mode <sup>*1, 3</sup>

\*1 Not displayed in Still Picture Recording Mode.

\*2 Not displayed in Motion Picture Recording Mode.

\*3 Available in Manual Mode (→ 47)

- If you turn off the unit or press the recording/playback button, PRE-REC, Backlight Compensation, Night Mode, Self-timer and Tele Macro functions are canceled.
- If you turn off the unit, the Fade function is canceled.
- It is possible to set from the menu.



## Fade



When you start recording, the image/audio gradually appears. (Fade in)

When you pause recording, the image/audio gradually disappears. (Fade out)

- The Fade setting is canceled when the recording stops.

### ■ To select the color for fade in/out

**MENU** : [RECORD SETUP] → [FADE COLOR] →  
[WHITE] or [BLACK]

(Fade in)



(Fade out)



- 
- The thumbnails of scenes recorded using fade in become black (or white).



## Intelligent Contrast Control



This brightens parts that are in shadow and difficult to see and suppresses white saturation in bright parts at the same time. Both bright and dark parts can be recorded clearly.

- 
- If there are extremely dark or bright parts or the brightness is insufficient, the effect may not be clear.



## PRE-REC

This prevents you from missing a shot.



This allows recording of the pictures and sound to start approximately 3 seconds before the recording start/stop button is pressed.

- appears on the screen.

---

- **Aim the unit at the subject beforehand.**

- There is no beep sound.
- PRE-REC is canceled in the following cases.
  - Press the recording/playback button
  - Touch the recording mode switching icon
  - If you remove the SD card
  - If you touch
  - If you turn the unit off
  - If you start recording
  - After 3 hours have passed
- After setting PRE-REC, if recording starts in less than 3 seconds, motion pictures taken 3 seconds before pressing the recording start/stop button cannot be recorded.
- Images displayed on the thumbnail in Playback Mode will differ from the motion pictures displayed at the start of playback.



## Self-timer



This is for recording still pictures using the timer.

Each time the icon is selected, the indication changes by one setting in the following order:

10 (Records after 10 seconds) → 2 (Records after 2 seconds) → setting canceled

- When you press the button, 10 or 2 flashes for the set period before a still picture is recorded. After recording, the Self-timer is canceled.
- In Auto Focus Mode, if the button is pressed halfway once and then fully, the lens focuses on the subject when the button is pressed halfway. If the button is pressed fully all at once, the lens focuses on the subject just before recording.

### ***To stop the timer midway through***

Touch [CANCEL].

- 
- Setting the Self-timer to 2 is a good way to prevent image shake when the button is pressed while using a tripod etc.



## Intelligent Exposure



This brightens dark areas so the image can be recorded clearly.

- 
- If there are extremely dark parts or the brightness is insufficient, the effect may not be clear.



## Backlight Compensation



This makes the image brighter to prevent darkening of a backlit subject.



## Tele Macro



A more impressive image can be obtained by focusing on the object only in close-up and shading off the background.

- The unit can focus on the subject at a distance of approx. 1.1 m (3.6 feet).
- When you set Tele Macro, the zoom magnification automatically changes to one of the following levels. In Still Picture Recording Mode, the level depends on the picture size setting. If you lower the zoom magnification to a level below the following values, Tele Macro will be canceled.

(Motion Picture Recording Mode)

– 62×\* (when the zoom magnification before you set Tele Macro was 62× or lower)

(Still Picture Recording Mode)

– 62× (when the picture size is set to [16:9 10M]/[16:9 2.1M] and the zoom magnification before you set Tele Macro was 62× or lower)

– 52× (when the picture size is set to [4:3 7.4M]/[4:3 0.3M] and the zoom magnification before you set Tele Macro was 52× or lower)

– 51× (when the picture size is set to [3:2 7.7M]/[3:2 2M] and the zoom magnification before you set Tele Macro was 51× or lower)

\* Scale factor when [O.I.S.] is set to [Standard] and Level Shot Function is set to off.





## Guidelines



You can check if the image is level while recording motion pictures and still pictures. The function can also be used to estimate the balance of the composition.

It will switch every time the icon is touched.

 →  →  → Setting canceled

- The guidelines do not appear on the images actually recorded.



## Night Mode



This function allows you to record color images in very low light situations. (Minimum required illumination: approx. 1 lx)

- Recorded scene is seen as if frames were missed.
- If set in a bright place, the screen may become washed out for a while.
- Bright dots that are usually invisible may be seen, but this is not a malfunction.
- Using a tripod is recommended.
- In darker areas, Auto Focus may focus a bit slower. This is normal.

# Recording functions of menu

## [SCENE MODE]













This function is identical to Scene Mode in Recording Mode. (→ 39)

The shutter speed and aperture, etc. are automatically adjusted to match the scene you want to record.

- This item is displayed in the menu only when [Time Lapse Rec] in Creative Control Mode is set. (→ 44)

**MENU** : [RECORD SETUP] → [SCENE MODE] → desired setting

[OFF]:	Cancel the setting
 <b>Sports:</b>	To make fast moving scenes less shaky with slow playback and pause of playback
 <b>Portrait:</b>	To make people stand out against the background
 <b>Soft Skin:</b>	To makes skin colors appear softer for a more attractive appearance
 <b>Spotlight:</b>	Improved quality when subject is brightly illuminated.
 <b>Snow:</b>	Improved image quality when shooting in snowy locations.
 <b>Beach:</b>	To make blue in the sea or sky vibrant
 <b>Sunset:</b>	To make red in the sunrise or sunset vibrant
 <b>Scenery:</b>	For spatial scenery
 <b>Fireworks:</b>	To capture the fireworks in the night sky beautifully
 <b>Night Scenery:</b>	To capture the evening or night scenery beautifully
 <b>Low Light:</b>	For dark scenes, such as at dusk

- Please refer to page 45 for details about the effect of each mode.

## [ZOOM MODE]



Set the maximum zoom ratio for the Motion Picture Recording Mode.

**MENU** : [RECORD SETUP] → [ZOOM MODE] → **desired setting**

<b>[i.Zoom OFF]:</b>	Up to 62×*
<b>[i.Zoom 90×]:</b>	This zoom function allows you to maintain high-definition picture quality. (Up to 90×)
<b>[D.Zoom 150×]:</b>	Digital zoom (Up to 150×)
<b>[D.Zoom 500×]:</b>	Digital zoom (Up to 500×)

\* The zoom magnification when [O.I.S.] is set to [Standard] and Level Shot Function is set to off.

- The larger the digital zoom magnification, the more the image quality is degraded.
- This function cannot be used in Still Picture Recording Mode.

## [REC FORMAT]



Switch the recording format of motion picture.

**MENU** : [RECORD SETUP] → [REC FORMAT] → **desired setting**

<b>[AVCHD]:</b>	Set the recording format to AVCHD. (→ 2)
<b>[MP4/iFrame]:</b>	Set the recording format to MP4/iFrame. (→ 2)

- This function's default setting is [AVCHD] mode.

## [REC MODE]



Switch the picture quality and recording format of the motion pictures to record. The recording formats that can be set change according to [REC FORMAT] setting.

**MENU** : [RECORD SETUP] → [REC MODE] → desired setting

### • When [REC FORMAT] is set to [AVCHD]

[PH]/[HA]/[HG]/[HE]: Set the recording format to 1080/60i.

(A ←→ B)

[1080/60p]<sup>\*1</sup>: Set the recording format to 1080/60p.

- A Favors image quality
- B Favors Recording time

### • When [REC FORMAT] is set to [MP4/iFrame]

[1080]<sup>\*2</sup>: Set the recording format to 1080/60p.

[720]<sup>\*2</sup>: Set the recording format to 720/30p.

[iFrame]<sup>\*3</sup>: Set the recording format to iFrame.

\*1 You can record motion pictures in 1080/60p (1920×1080/60 progressive), the best AVCHD picture quality for this unit.

\*2 [1080] and [720] are recording modes suitable for playing back or editing on a PC.

\*3 [iFrame] is a format suitable for Mac (iMovie etc.). It is recommended for when using a Mac.

### • Please refer to page 11 for details about recordable time using the battery.

- This function's default setting is [HG] mode.
- Please refer to page 133 for details about approximate recordable time.
- When the unit is moved a lot or moved quickly, or when a fast-moving subject is recorded, mosaic-type noise may appear at playback.

## [FACE FRAMING]



Detected faces appear with frames.

**MENU** : [RECORD SETUP] → [FACE FRAMING] → desired setting

### [PRIMARY]:

Only the prioritized face framing is displayed.

### [ALL]:

All face detection framings are displayed.

### [OFF]:

Cancel the setting.

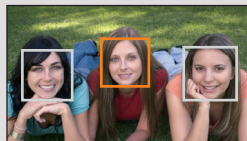

- Up to 5 frames are indicated. Larger faces and faces nearer to the center of the screen take preference over others.

## ■ Prioritized face framing

Prioritized face framing is displayed as orange frames. Focus and adjustment of brightness will be performed against the prioritized face framing.

- The prioritized face frame is displayed only with Portrait Mode in Intelligent Auto Mode or Intelligent Auto Plus Mode.
- The white frame is for face detection only.
- Focus will be set to prioritized face framing when the  button is pressed halfway when recording still pictures. Prioritized face framing will turn to green when the focus is set.

## [LEVEL GAUGE]



This function displays the horizontal/vertical tilt of the unit with the electronic level.

 : [RECORD SETUP] → [LEVEL GAUGE] → [ON]

## ■ To correct the tilt

(Horizontal direction)

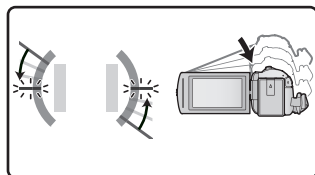

When correcting the leftward tilt

(Vertical direction)

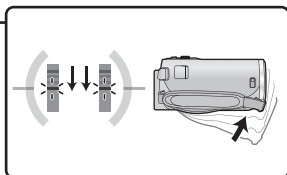

When correcting the downward tilt

- The horizontal tilt display **A** and vertical tilt display **B** appear yellow when there is a tilt, and appear green when there is almost no tilt.
  - The maximum tilt display angles are approximately 45 ° in horizontal direction and 10 ° in vertical direction.
  - The electronic level does not affect the actual recorded images.
- 
- The electronic level is not displayed when recording yourself or the LCD monitor is closed with the screen facing outward.
  - Even when the tilt is in the corrected state, an error of approximately 1 ° may occur.
  - In the following cases, the electronic level may not be displayed correctly:
    - When moving this unit
    - When pointing this unit up or down at an angle closer to perpendicular

## [AGS]



If the unit continues to be tilted upside down from the normal horizontal position while recording motion pictures, it is automatically put into recording pause.

**MENU** : [RECORD SETUP] → [AGS] → [ON]

- The AGS function may activate and cause the unit to pause the recording if you are recording a subject right above or right below you.

## [AUTO SLOW SHTR]



You can record bright pictures even in dark places by slowing the shutter speed.

- **Switch to Manual Mode.** (→ 47)

**MENU** : [RECORD SETUP] → [AUTO SLOW SHTR] → [ON]

- The shutter speed is set to 1/30 or more depending on the surrounding brightness.
- This function cannot be used in Still Picture Recording Mode.
- When the shutter speed becomes 1/30, the screen may be seen as if frames are missed and afterimages may appear.

## [Digital Cinema Color]



Recording motion pictures with more vivid colors, using x.v.Color™ technology.

- **Switch to Manual Mode.** (→ 47)
- **Set [REC FORMAT] to [AVCHD].** (→ 61)

**MENU** : [RECORD SETUP] → [Digital Cinema Color] → [ON]

- For more realistic colors, use an HDMI mini cable (supplied) with a TV that supports the x.v.Color™.
- **When motion pictures recorded while this function is turned [ON] are played back with a TV not compatible with x.v.Color™, colors may not be reproduced properly.**
- When these images are played back with devices other than ones compatible with x.v.Color™, it is recommended to record the images after this function is turned [OFF].
- x.v.Color™ is a name for devices that are compatible with the xYCC format, an international standard for expanded color in motion pictures, and that follow the rules for signal transmission.



## [SHOOTING GUIDE]



Message is displayed when this unit is moved rapidly.

**MENU** : [RECORD SETUP] → [SHOOTING GUIDE] → [ON]

When “CAMERA PANNING IS TOO FAST.” appears, move the unit slowly while recording.

- In the following cases, message will not appear:
  - While pausing the recording (only when [DEMO MODE] is not set to [ON])
  - When [LEVEL GAUGE] is set to [ON]

## [WIND CUT]



This is for reducing the wind noise coming into the built-in microphones.

- **Switch to Manual Mode.** (→ 47)

**MENU** : [RECORD SETUP] → [WIND CUT] → [ON]

- This function's default setting is [ON].
- When switching to Intelligent Auto Mode/Intelligent Auto Plus Mode, [WIND CUT] is set to [ON], and the setting cannot be changed.
- You may not see the full effect depending on the recording conditions.

## [MIC SETUP]



Recording setting of the built-in microphone can be adjusted.

- **Set [REC FORMAT] to [AVCHD].** (→ 61)

**MENU** : [RECORD SETUP] → [MIC SETUP] → **desired setting**

### [STEREO MIC]:

Sound from two directions is recorded in 2 ch by forward-facing stereo microphones.

### [ZOOM MIC]:

Sound is recorded with changing the directionality in conjunction with the zoom operation. Sounds near the front of the unit are recorded more clearly if you zoom in (close-up) and surrounding sounds are recorded more realistically if you zoom out (wide angle).

- [MIC SETUP] will become [STEREO MIC] when the [REC FORMAT] is set to [MP4/iFrame].

## [MIC LEVEL]



When recording, the input level from the built-in microphones can be adjusted.

### 1 Select the menu.

**MENU** : [RECORD SETUP] → [MIC LEVEL] → desired setting

[AUTO]:	AGC is activated, and the recording level is adjusted automatically.
[SET  ]:	The desired recording level can be set. AGC is activated, and sound distortions are reduced.
[SET  ]:	The desired recording level can be set. Sounds are recorded in natural quality.

### 2 (When [SET ]/[SET ] is selected)

Touch / to adjust.

- Adjust the microphone input level so that the last 2 bars of the gain value are not red. (Otherwise, the sound is distorted.) Select a lower setting for microphone input level.

### 3 Touch [ENTER].

- Touch [EXIT] to complete the setting.
- (Microphone input level meter) appears on the screen.

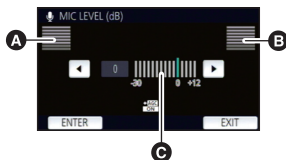

- A Left
- B Right
- C Microphone input level

- You cannot record with the audio completely muted.

## [PICTURE ADJUST]



Adjust the quality of the image while recording.

Adjust by outputting to a TV while adjusting the quality of the image.

- This setting is retained when you change between Motion Picture Recording Mode and Still Picture Recording Mode.**
- Switch to Manual Mode. (→ 47)

### 1 Select the menu.

**MENU** : [RECORD SETUP] → [PICTURE ADJUST]

### 2 Touch the desired setting items.

[SHARPNESS]:	Sharpness of the edge
[COLOR]:	Depth of the color of the image
[EXPOSURE]:	Brightness of the image
[WB ADJUST]:	Picture color balance

### 3 Touch / to adjust settings.

### 4 Touch [ENTER].

- Touch [EXIT] to complete the settings.
- appears on the screen.

## [PICTURE SIZE]



The higher the number of pixels, the higher the clarity of the picture when printing.

**MENU** : [PICTURE] → [PICTURE SIZE] → desired setting

### ■ Picture size and Maximum zoom ratio in Still Picture Recording Mode

Aspect ratio will change depending on the picture size.

**[16:9]**: Aspect ratio of high-definition television, etc.

**[4:3]**: Aspect ratio of 4:3 television

**[3:2]**: Aspect ratio of conventional film camera or prints (such as L-size print)

Picture size	Aspect ratio	Extra Optical Zoom (→ 37)
[16:9] 10M]	[16:9]	—*1
[16:9] 2.1M]		—*1
[4:3] 7.4M]	[4:3]	—*2
[4:3] 0.3M]		100×
[3:2] 7.7M]	[3:2]	—*3
[3:2] 2M]		—*3

\*1 Extra Optical Zoom cannot be used. The maximum zoom magnification is 62×.

\*2 Extra Optical Zoom cannot be used. The maximum zoom magnification is 52×.

\*3 Extra Optical Zoom cannot be used. The maximum zoom magnification is 51×.

- This function's default settings are [16:9] 10M] in Still Picture Recording Mode.
- Still pictures taken in Motion Picture Recording Mode are [2.1M] (1920×1080).
- The recording will become longer depending on the picture size.
- Please refer to page 134 for details about the number of recordable pictures.
- When the picture size is [4:3] 7.4M], [4:3] 0.3M], [3:2] 7.7M] or [3:2] 2M] black bands may appear on the left and right of the screen.
- The edges of still pictures recorded on this unit with a 16:9 aspect ratio may be cut at printing. Check the printer or photo studio before printing.

## [SHTR SOUND]



You can add a shutter sound when recording still pictures.

**MENU** : [PICTURE] → [SHTR SOUND] → desired setting

: Volume low

: Volume high

**[OFF]**: Cancel the setting.

- No shutter sound is emitted in Motion Picture Recording Mode.

# Playback Operations

## Motion picture playback using operation icon



For details on the basic playback operations, refer to page 24.

Playback operation	Playback display	Operating steps
Skip Playback (to the start of a scene)	<p>During Playback</p>	Touch the LCD monitor and slide from right to left (from left to right) during playback.
Slow-motion Playback	<p>During Pause</p>	<p>With the playback paused, continue touching .</p> <p>( is for slow rewind playback)</p> <p>Frame-by-frame Slow-motion Playback is performed continuously while the display is touched and held.</p> <ul style="list-style-type: none"> <li>Normal playback is restored when you touch .</li> <li>The intervals between frames and the display time per frame vary depending on the type of the scene.</li> </ul>
Frame-by-frame Playback		<p>With the playback paused, touch .</p> <p>(Touch  to advance the frames one at a time in the reverse direction.)</p> <ul style="list-style-type: none"> <li>Normal playback is restored when you touch .</li> <li>The intervals between frames vary depending on the type of the scene.</li> </ul>
Direct Playback	<p>During Pause</p>	<p>Touch the direct playback bar or slide it while touching.</p> <ul style="list-style-type: none"> <li>The playback skips to the position touched or slid to while touching.</li> </ul>

## Creating still picture from motion picture



A single frame from the recorded motion picture can be saved as a still picture.  
The size of pictures to be recorded is determined by their scene type.

Scene type	Picture size
AVCHD scenes Scenes recorded in the recording format [MP4/iFrame] Scenes saved in MP4 (1280×720/30p)	2.1M (1920×1080)
Scenes saved in MP4 (640×360/30p)	0.2M (640×360)

Press the  button fully at the location to be saved as a still picture during playback.

- It is convenient to use Pause, Slow-motion Playback and Frame-by-frame Playback.
- Date the motion picture was recorded will be registered as date of the still picture.
- Quality will be different from the normal still picture.



## Highlight & Time Frame Index



An image of one scene is displayed as a thumbnail at set search condition. Scene can be played back from any midway point of the scene you wish to see.

- Operate the zoom lever to  side and change over the thumbnail display to Highlight & Time Frame Index. (→ 25)

### 1 Touch .

- To display the next (previous) page:
  - Slide the thumbnail display upward (downward) while touching it.
  - Touch  (up) /  (down) on the thumbnail scroll lever. (→ 25)





### 2 Touch the desired search condition.

[3 SEC.]/[6 SEC.]/[12 SEC.]/[MINUTES]/[FACE]\*/[HIGHLIGHT]\*

\* It cannot be set while playing back MP4/iFrame scenes.



- When select [FACE], it will select the portion for which Face Recognition was performed from the scenes judged to be clearly recorded. This will then be displayed as a thumbnail.
- A portion judged to be clearly recorded will be detected and displayed in thumbnail if you select [HIGHLIGHT].

### 3 (When [MINUTES] is selected)

Touch  /  to set the time.

- It can be set up to a maximum of 60 minutes.
- Touch [ENTER].

### 4 Touch the thumbnail to be played back.

- Next (Previous) thumbnail can be displayed by touching  / .

## Repeat Playback



Playback of the first scene starts after playback of the last scene finishes.

MENU : [VIDEO SETUP] → [REPEAT PLAY] → [ON]

The  indication appears on the full screen views.

- All the scenes are played back repeatedly. (When playing back motion pictures by date, all the scenes on the selected date are played back repeatedly.)

## Resuming the previous playback



If playback of a scene was stopped halfway, the playback can be resumed from where it was stopped.

**MENU** : [VIDEO SETUP] → [RESUME PLAY] → [ON]

If playback of a motion picture is stopped, appears on the thumbnail view of the stopped scene.

- The memorized resume position is cleared if you turn off the unit or press the recording/playback button.  
(The setting of [RESUME PLAY] does not change.)

## Zooming in on a still picture during playback (Playback zoom)



You can zoom in by touching a still picture during playback.

### 1 Touch and hold the part you wish to zoom in on during still picture playback.

- It will display enlarged in order of normal display (×1) → ×2 → ×4. Touch and hold the screen to zoom in from the normal display (×1) to ×2. Touch the screen to zoom in from ×2 to ×4.
- The still picture is zoomed in on, centering on the part you touched.

### 2 Move to the zoomed in position by touching / / / or slide while touching the screen.

- The location of the zoom displays for about 1 second when zooming in (zooming out) or moving the displayed location.

### Zooming out from the zoomed still picture

Touch to zoom out. (×4 → ×2 → ×1)

- Touch to return to normal playback (×1).



- **A** Displayed location of the zoom

- You can also perform zoom operations using the zoom lever.
- The more you zoom in, the lower the image quality will be.

# Various playback functions

## Playing back motion pictures/still pictures by date



The scenes or the still pictures recorded on the same day can be played back in succession.

### 1 Touch the date select icon. (→ 17)



A Date select icon

### 2 Touch the playback date.

The scenes or the still pictures recorded on the date selected are displayed as thumbnails.

### 3 Touch the scene or the still picture to be played back.

- If you press the recording/playback button to switch between Recording Mode and Playback Mode, the [VIEW ALL] screen will be displayed again.
- In cases such as those described below, scenes and still pictures are grouped separately on the date list, and -1, -2... may be added after the date:
  - When the number of scenes exceeds 99
  - When the number of still pictures exceeds 999
  - When [REC MODE] in [AVCHD] is changed
  - When recorded in Creative Control Mode.
  - When recorded in Endless Loop Recording
  - When saved in Manual Edit (→ 81)
  - When [NUMBER RESET] is performed
- The following scenes and still pictures are grouped separately on the date list, and icons are displayed according to the category:

Scene or still picture	Icon to be displayed
Scenes recorded with [1080/60p] in [AVCHD]	
Scenes recorded with [1080] in [MP4/iFrame]	
Scenes recorded with [720] in [MP4/iFrame]	
Scenes recorded with [iFrame] in [MP4/iFrame]	
Still pictures created from motion pictures	
Scenes saved in Highlight Playback (→ 78)	
Scenes saved in MP4 (1280×720/30p) (→ 89)	
Scenes saved in MP4 (640×360/30p) (→ 89)	



# Highlight Playback



Part that was recognized as clearly recorded is extracted from multiple scenes, and it can be played back or stored in a short time with effects and music added.

It is also possible to create an original Highlight Playback by checking your favorite scenes and setting up to extract those scenes.

## 1 Touch . (→ 17)

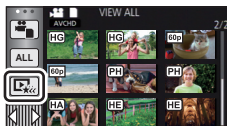

## 2 Touch the desired effect.

[POP]:	Recommended for party scene.
[NATURAL]:	Recommended for scenery.
[CLASSICAL]:	Recommended for slow moving scene.
[DYNAMIC]:	Recommended for fast moving scene such as sports scene.
[CUSTOM]:	Set the combination of the effect and the music. (→ 74)

- The scenes matching the effect will be extracted and displayed in the thumbnail view.
- Effects such as fade, slow-motion, still (pause), or digest playback are inserted.
- The date at playback is the date that was last recorded in an extracted scene.
- To change the settings, refer to page 75.

## 3 Touch in the thumbnail view.

## 4 Select the playback operation. (→ 25)

- When the playback is finished or stopped, the screen to select [REPLAY], [SAVE] (→ 78), [SELECT AGAIN] or [EXIT] is displayed. Touch the desired item.

---

### • Highlight Playback is not available for the following scenes :

- MP4/iFrame scenes
- Scenes recorded with Creative Control Mode (→ 42)
- Scenes saved as Highlight Playback
- Scenes saved as manually-edited scenes (→ 79)
- Skip Playback, Slow-motion Playback, Frame-by-frame Playback and Direct Playback are not possible.

## ■ Setting up the custom effect

It is possible to enjoy the Highlight Playback with your favorite effect by setting up the combination of an image effect and music.

1 Touch **[CUSTOM]**.

2 Touch **[EFFECT SETUP]** or **[MUSIC SELECT]**.



3 (When [EFFECT SETUP] is selected)

**Touch the desired effect.**

- When [EFFECT SETUP] is changed, [MUSIC SELECT] will be set the same as [EFFECT SETUP]. (To set [EFFECT SETUP] and [MUSIC SELECT] to different settings, change [MUSIC SELECT] after setting [EFFECT SETUP].)

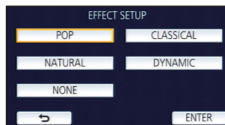

(When [MUSIC SELECT] is selected)

**Touch the desired sound.**

- When [EFFECT SETUP] is set to [NONE], you will be able to select [NO MUSIC]. When [NO MUSIC] is selected, the audio recorded at the time of shooting is played back.

(To test the music audio)

**Touch [START].**

- Touch the other music option to change the music to be tested.
- When you touch [STOP], the music playback stops.

4 Touch **[ENTER]**.

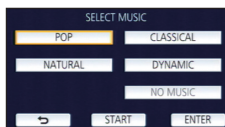

## Playing back with the settings changed

Touch [SET] to select the item to change.

### [SCENE SETUP]\*1:

Select the scene or date to be played back.

### [FAVORITE SCENE SETUP]\*2:

Set up the favorite scenes. (→ 76)

### [FAVORITE SCENE PLAY]\*2:

Set up if the favorite scenes are to be included in the Highlight Playback or not. (→ 76)

### [PRIORITY SETUP]:

Select the target to give priority to play back. (→ 76)

### [PLAYBACK TIME]:

Select the time to play back. (→ 77)

### [TITLE SETUP]:

Select the cover image and enter the title.

They are displayed at the beginning. (→ 77)



\*1 If you touch [SET] of Highlight Playback when the Baby Calendar is displayed, [SELECT DATE] and [SELECT SCENES] will not be available. (→ 82)

\*2 If you touch [SET] of Highlight Playback when the Baby Calendar is displayed, these items will not be displayed. (→ 82)

• When you have finished changing the settings, touch [EXIT].

## ■ Scene setting

1 (Only when Highlight Playback is started from [ALL AVCHD])

**Touch the recording format of the scene to be played back.**

[1080/60p]/[1080/60i]

2 Touch [SELECT DATE] or [SELECT SCENES].

3 (When [SELECT DATE] is selected)

**Touch the date to be played back.**

• A maximum of 7 days can be selected.

• When touched, the date is selected and surrounded by red. Touch the date again to cancel the operation.

(When [SELECT SCENES] is selected)

**Touch the scenes to be played back.**



• Up to 99 scenes can be selected in succession.

• When touched, the scene is selected and ✓ is displayed. Touch the scene again to cancel the operation.

4 Touch [Enter]/[ENTER].

## ■ Checking the favorite scenes

- 1 Touch the scenes to be played back.
- 2 Touch [Add] and add the favorite part.

- Approximately 4 seconds before and after touching [Add] will be added as favorite.
- Number of favorite scenes that can be added are 1 to 14. (Number of scenes that can be added differs depending on the scenes selected.)
- Favorite check display  (A) is displayed in orange, and favorite check display  (B) is displayed on the slide bar.
- To cancel the favorite, play back to the position checked as favorite, and touch [Cancel].
- It is convenient to use Slow-motion Playback and Frame-by-frame Playback. (→ 68)

- 3 Touch  and stop the playback.

- It will return to the thumbnail display screen and  is displayed on the scenes added as favorite scenes.

- 4 Touch [Return].

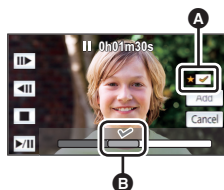

- All the scenes checked as favorite may not be played back depending on the playback time setting. (→ 77)

### To clear the favorite scenes from the thumbnail display

- 1 Touch [Reset].
- 2 Touch [RESET ALL] or [RESET SELECTED].

- The check on all the favorite scenes will be cleared when [RESET ALL] is selected.

- 3 (When [RESET SELECTED] is selected in Step 2)  
Touch the scene to be cleared.

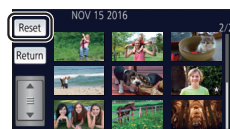

## ■ Playing back the favorite scenes

Touch [ON] or [OFF].

**[ON]:** Include the scenes added in the [FAVORITE SCENE SETUP] into the Highlight Playback.

**[OFF]:** Do not include the scenes added in the [FAVORITE SCENE SETUP] into the Highlight Playback.

## ■ Priority settings

Touch [NONE] or [FACE].

- If you touch [FACE], priority is given to the part detected as a face.

## ■ Playback time setting

Touch the playback time.

[APPROX 90 SEC.]/[APPROX 3 MIN.]/[AUTO]

- The playback time of [AUTO] is a maximum of approx. 5 minutes.
- Playback time may become shorter than the setting, or it may not even be played back if the part recognized as clearly recorded is short.

## ■ Setting up the title

1 Touch ◀/▶ to select your favorite title sheet.

[NONE]/[PICTURE 1]/[PICTURE 2]/[PICTURE 3]/[PICTURE 4]

- Title and date will not be displayed when [NONE] is selected.

2 Touch [TITLE].

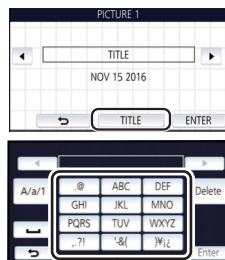

Ⓐ Text entry icon

3 Enter the title.

- Touch the text entry icon in the center of the screen and enter the title.
- After entering the title, touch [Enter].

### Entering text

- The characters can be conveniently input without moving the cursor when the [Auto Cursor Position] is set to [ON]. (→ 33)

Icon	Description of operation
[A] etc.	Enters a character.
◀/▶	Moves the cursor to left or right.
[A/a/1]	Switches between [A]/[a] (alphabet) and [&/1] (symbols/numbers).
↵	Enters a space.
[Delete]	Deletes a character. Deletes the previous character if the cursor is in an empty space.
[Enter]	Ends text entry.

- A maximum of 18 characters can be entered.

4 Touch [ENTER] to end registration.

- The date of the first scene of the Highlight Playback will be displayed as the date.

- The entered title will be cleared when the unit is turned off or the Highlight Playback is finished.

## Saving the Highlight Playback

The scenes put together as a Highlight Playback can be saved as a single scene.  
The recorded scenes can be saved in the SD card.

- 1 Stop the playback of the Highlight Playback or wait until the Highlight Playback is finished.**
- 2 Touch [SAVE].**
- 3 Select the format to save.**

<b>[AVCHD 1920×1080/60i]:</b>	It will be saved in high-definition image quality.
<b>[MP4 1280×720/30p]:</b>	It will be saved with an image quality that allows you to upload it on the Internet in higher image quality. The format supports playback on a PC.
<b>[MP4 640×360/30p]:</b>	It will be saved with an image quality that allows you to upload it on the Internet faster. The format supports playback on a PC.

(When [AVCHD 1920×1080/60i] is selected)

- Scenes recorded in 1080/60p are converted to 1080/60i (picture quality [HA] of [REC MODE]) and saved.
  - Scenes recorded in 1080/60i are recorded in [HA] regardless of [REC MODE] ([PH]/[HA]/[HG]/[HE]) of a scene.
- 4 Touch [YES].**
  - 5 Touch [EXIT].**

- 
-  is displayed on the thumbnail of the scenes saved by the Highlight Playback.

# Manual Edit



You can join desired scenes or parts of scenes in the order they were recorded to play back or save as a single scene with music added.

- **Manual Edit cannot be used for MP4/iFrame scenes.**

## 1 Select the menu.

**MENU** : [EDIT SCENE] → [MANUAL EDIT]

## 2 Touch [1080/60p] or [1080/60i].

- Touch [Enter].
- Thumbnails are displayed by each scene.

## 3 Select the scene or part of the scene to play back, and set the music.

- To select a scene (→ 80)
- To select part of a scene (→ 80)
- To set the music (→ 81)
- Touching [Return] after selecting a scene may cancel the selected scene.

## 4 Touch [Enter].

## 5 Touch [YES], and select the playback operation for the edited scene. (→ 25)

- In the following cases, the screen for selecting [PREVIEW], [SAVE] (→ 81), [SELECT AGAIN], and [EXIT] is displayed. Touch the desired item.
  - Touch [NO]
  - Playback finishes
  - Stop playback

- You can also select combinations of scenes and parts of scenes.
- You can select up to 99 scenes. (Each 3 second thumbnail of part of a scene is treated as a single scene.)
- You can create a combined scene of up to about 6 hours long.
- Skip Playback, Slow-motion Playback, Frame-by-frame Playback and Direct Playback are not possible.
- When saving a manually edited scene, check the free space on the SD card.

Before selecting the scene, check the table below and create sufficient free space for saving it.  
**(Approximate free space requirements for saving a manually edited scene)**

Saving format	Total time of an edited scene	Free space required
[AVCHD 1920×1080/60i]	30 min	Approx. 4 GB
	1 h	Approx. 8 GB
[MP4 1280×720/30p]	30 min	Approx. 2 GB
	1 h	Approx. 4 GB
[MP4 640×360/30p]	30 min	Approx. 0.4 GB
	1 h	Approx. 0.8 GB

- "h" is an abbreviation for hour, "min" for minute and "s" for second.

## ■ To select a scene

### Touch the scene to be played back.

- The scene selection is made as you touch it, and the  indication appears on the thumbnail. To cancel the operation, touch the scene again.
- When part of a scene has been selected, the  3S indication appears on the thumbnail. If you touch the thumbnail, the scene will be displayed by 3 second thumbnails.
- Next (previous) page is displayed by touching ▲/▼.

## ■ To select part of a scene

### 1 Touch [3 sec].

- To cancel the operation, touch it again.

### 2 Touch the desired scene.

- The touched scene is displayed by 3 second thumbnails.

### 3 (To select a single thumbnail)

#### Touch the thumbnail of the part you want to play back.

- The thumbnail selection is made as you touch it, and the  indication (white) appears on the thumbnail. To cancel the selection, touch the thumbnail again.
- Next (previous) thumbnail is displayed by touching ◀/▶.
- Touching [Return] when the thumbnail has been selected returns you to the screen that displays the thumbnails of scenes. The  3S indication appears on the thumbnail of the scene containing the selected part.

### 4 (To select thumbnails by specifying a range)

#### Touch [Range].

- To cancel the operation, touch it again.

### 5 (To select thumbnails by specifying a range)

#### Touch the range (start and finish points) you want to play back.

- The range between start and finish points are selected, and the  indication (white) appears on the thumbnails.
- To cancel the selected thumbnails, from among the thumbnails with the  indication (white), touch the range (start and finish points) you want to cancel.
- If you touch [Enter]/[Return]/[Music]/[Range] when a start point has been selected, the start point thumbnail will be canceled.
- Touching [Return] when the thumbnail has been selected returns you to the screen that displays the thumbnails of scenes. The  3S indication appears on the thumbnail of the scene containing the selected part.
- You can also select multiple ranges within the same scene.
- Next (previous) thumbnail is displayed by touching ◀/▶.
- To select other scenes, touch [Return] to return to the screen that displays the thumbnails of scenes, and perform the following operations.
  - When selecting a scene:  
Touch the desired scene.
  - When selecting part of a scene:  
Perform the operations in Steps 1-5.



- A Start point
- B Finish point



## ■ To set the music

### 1 Touch [Music].

### 2 Touch the desired sound.

- When [NO MUSIC] is selected, the audio recorded at the time of shooting is played back.

(To test the music audio)

### Touch [START].

- Touch the other music option to change the music to be tested.
- When you touch [STOP], the music playback stops.

### 3 Touch [ENTER].

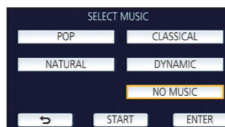

## ■ To save a manually-edited scene

You can save manually edited scenes as a single scene.

The recorded scenes can be saved in the SD card.

### 1 Stop the playback of a manually-edited scene or wait until the playback is finished.

### 2 Touch [SAVE].

### 3 Select the format to save.

#### [AVCHD 1920×1080/60i]:

It will be saved in high-definition image quality.

#### [MP4 1280×720/30p]:

It will be saved with an image quality that allows you to upload it on the Internet in higher image quality. The format supports playback on a PC.

#### [MP4 640×360/30p]:

It will be saved with an image quality that allows you to upload it on the Internet faster. The format supports playback on a PC.

(When [AVCHD 1920×1080/60i] is selected)

- Scenes recorded in 1080/60p are converted to 1080/60i (picture quality [HA] of [REC MODE]) and saved.
- Scenes recorded in 1080/60i are recorded in [HA] regardless of [REC MODE] ([PH]/[HA]/[HG]/[HE]) of a scene.

### 4 Touch [YES].

- If you are using the battery, a message recommending that you use the AC adaptor will be displayed. To start the saving operation, touch [START].

### 5 Touch [EXIT].

- 
- You can save scenes even when using the battery, but we recommend that you use the AC adaptor.
  - For information on the approximate free space requirements for saving a manually edited scene, refer to page 79.

# Baby Calendar



When a baby's birthday and name are registered, scenes recorded since the baby's birthday are displayed as thumbnails for each age in months.

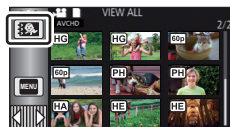

- Scenes recorded before the birthday are not displayed.
- Scenes with no baby in them are also displayed.
- You can register up to 3 babies.

## 1 Touch .



## 2 (When registering for the first time)

### Enter the baby's birthday.



- Touch the date to be set, then set the desired value using  / .
- The year can be set between 2000 and 2039.
- Touch [Enter].

## 3 (When registering for the first time)

### Touch [YES], and enter the baby's name.

- If you touch [NO], the Baby Calendar will be displayed without the baby's name registered. ([Baby 1] is displayed.)
- Input method is same operation as for setting up the title. (→ 77)
- After entering the name, touch [Enter].
- A maximum of 9 characters can be entered.

## 4 Check the Baby Calendar.

- The name of the registered baby and its age in months are displayed.
- You can switch the age in months display by touching  / .

### : Changes the age in months display to that of the previous month

If you touch this icon when the youngest age in months is displayed, the oldest age in months will be displayed.

### : Changes the age in months display to that of the next month

If you touch this icon when the oldest age in months is displayed, the youngest age in months will be displayed.

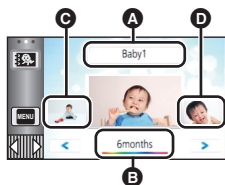

- A** Name display
- B** Age in months display
- C** Thumbnail for the previous age in months
- D** Thumbnail for the next age in months

- Except for months with no recordings, the age in months display is available for each month.
- If you touch the name display, the screen for selecting a registered baby is displayed. From among the 3 registered babies, select the baby you want to display and touch [ENTER]. If you touch a name with no registered birthday ([Baby 1]/[Baby 2]/[Baby 3]), you can register a new baby. Perform Steps 2-3.

## 5 Touch the thumbnail in the center.

- The thumbnails of the scenes recorded in the same age in months are displayed. Touch the desired scene to select the playback operation. (→ 25)
- The thumbnail display cannot be set to 1 scene/20 scenes display or to the Highlight & Time Frame Index.
- You cannot perform Highlight Playback if the number of scenes exceeds 99.
- Touching  returns you to the screen that lets you select the age in months.

### To return to the normal thumbnail display

Touch the  while the Baby Calendar is displayed.

### To change/add a baby's registered details

- 1 Touch the name display on the Baby Calendar (→ 82) or select the menu.

 : [VIDEO SETUP] → [Baby Calendar Setup]

## 2 Touch the name of the baby whose details are to be changed.

- When [Baby 1]/[Baby 2]/[Baby 3] is displayed, the birthday and name or name only are not registered.

## 3 Touch the desired item.

<b>Name:</b>	Register/change the name.
<b>Birthday:</b>	Register/change the birthday.

- The setting method is the same as when registering for the first time. (→ 82)

## 4 Touch [ENTER].

- The Baby Calendar of the registered baby is displayed.

### To delete a baby's registered details

- 1 Touch the name display on the Baby Calendar (→ 82) or select the menu.

 : [VIDEO SETUP] → [Baby Calendar Setup]

## 2 Touch the name of the baby whose details are to be deleted.

## 3 Touch [DELETE].

- To delete the registered details of other babies, repeat Steps 2 to 3.

- 
- When the Baby Calendar is displayed, the following operations are not available:
    - [SCENE PROTECT]
    - [SECTION DELETE]
    - [DIVIDE]
    - [MANUAL EDIT]
    - [SPLIT&DELETE]
    - [CONVERT TO MP4]

# Changing the playback settings and playing back the slide show



**1** Touch  . (→ 17)

**2** (Only when you would like to change the settings)  
Touch **[SET]** to select the item to change.

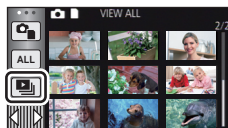

<b>[DATE SETUP]:</b>	Select the date to be played back.
<b>[SLIDE INTERVAL]:</b>	Select the interval between still pictures at playback.
<b>[EFFECT SETUP]:</b>	Select the effect for playback.
<b>[MUSIC SELECT]:</b>	Select the music to be played on playback.

**3** (When [DATE SETUP] is selected)  
Touch the **playback date**.

(When [SLIDE INTERVAL] is selected)  
Touch the **interval of playback for the slide show**.

<b>[SHORT]:</b>	Approx. 1 second
<b>[NORMAL]:</b>	Approx. 5 seconds
<b>[LONG]:</b>	Approx. 15 seconds

(When [EFFECT SETUP] is selected)  
Touch the **desired effect**.

- Touch [ENTER].
- When [EFFECT SETUP] is changed, [MUSIC SELECT] will be set the same as [EFFECT SETUP]. (To set [EFFECT SETUP] and [MUSIC SELECT] to different settings, change [MUSIC SELECT] after setting [EFFECT SETUP].)
- [SLIDE INTERVAL] cannot be set, when [EFFECT SETUP] is set.

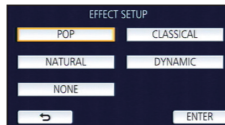

(When [MUSIC SELECT] is selected)  
Touch the **desired sound**.

- Touch [ENTER].
- (To test the music audio)  
Touch **[START]** and start the audio testing.
- Touch the other music option to change the music to be tested.
- When you touch [STOP], the music playback stops.

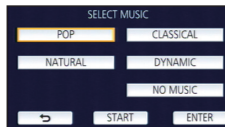

**4** Touch **[START]**.

**5** Select the playback operation. (→ 25)

- When the playback is finished or stopped, the screen to select [REPLAY], [SELECT AGAIN] or [EXIT] is displayed. Touch the desired item.

# Deleting scenes/still pictures

Deleted scenes/still pictures cannot be restored, so perform appropriate confirmation of the contents before proceeding with deletion.

◇ Press the recording/playback button to switch this unit to the Playback Mode.

■ To delete the scene or still picture being played back

Touch  while scenes or still pictures to be deleted are being played back.



■ To delete scenes or still pictures from the thumbnail display

● Switch to the thumbnail display of the scenes or still pictures to delete. (→ 24)

1 Touch . (→ 17)

● When the thumbnail display is 1 scene display or Highlight & Time Frame Index, the scene or still picture being displayed is deleted.

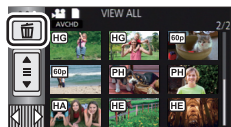

2 Touch [ALL SCENES], [MULTI] or [SINGLE].

● All the scenes or still pictures displayed as thumbnails will be deleted by selecting [ALL SCENES].  
(In case of playing back scenes or still pictures by date, all the scenes or still pictures on the selected date will be deleted.)

● Protected scenes/still pictures cannot be deleted.



3 (When [MULTI] is selected in Step 2)

**Touch the scene/still picture to be deleted.**

● When touched, the scene/still picture is selected and the  indication appears on the thumbnail.  
Touch the scene/still picture again to cancel the operation.

● Up to 99 scenes can be selected to be deleted.

(When [SINGLE] is selected in Step 2)

**Touch the scene/still picture to be deleted.**

4 (When [MULTI] is selected in Step 2)

**Touch [Delete].**

● To continuously delete other scenes/still pictures, repeat Steps 3-4.

**When you stop deleting halfway:**

Touch [CANCEL] while deleting.

● The scenes or still pictures that have already been deleted when the deletion is canceled cannot be restored.

**To complete editing:**

Touch [Return].

- You can also delete scenes by touching **MENU**, selecting [EDIT SCENE] → [DELETE] → [ALL SCENES], [MULTI] or [SINGLE].
- You can also delete still pictures by touching **MENU**, selecting [PICT. SETUP] → [DELETE] → [ALL SCENES], [MULTI] or [SINGLE].
- During Highlight Playback, scenes/still pictures cannot be deleted.
- Scenes that cannot be played back (the thumbnails are displayed as **!**) cannot be deleted.
- In case of [ALL SCENES], the deletion may take time if there are many scenes or still pictures.
- If you delete scenes recorded on other products or still pictures conforming to DCF standard with this unit, all the data related to the scenes/still pictures may be deleted.
- When still pictures recorded on an SD card by other products are deleted, a still picture (other than JPEG) that cannot be played back on this unit, may be erased.

## Deleting part of a scene (AVCHD)



Unnecessary part of an AVCHD scene can be deleted.

The deleted scenes cannot be restored.

- Press the recording/playback button to switch this unit to the Playback Mode, and touch the play mode select icon. Then, select the AVCHD scene. (→ 24)

### 1 Select the menu.

**MENU** : [EDIT SCENE] → [SECTION DELETE]

### 2 Touch the scene with a part to delete.

### 3 Set the section to delete by touching and sliding the top and bottom section selection buttons



- It is convenient to use Slow-motion Playback and Frame-by-frame Playback. (→ 68)



### 4 Touch [ENTER].

### 5 Confirm (play back) the scene after editing by touching [YES].

- A confirmation message appears when [NO] is touched. Proceed to Step 7.

### 6 Stop the playback.

- A confirmation message appears.

### 7 Touch [ENTER].

- Repeat Steps 2-7 to continuously delete parts from other scenes.

### To complete editing

Touch [Return].

- Deleting a part of a scene cannot be performed when there are 99 scenes in a single date.
- It may not be possible to delete part of a scene with a short recording time.
- The scene will be divided into two scenes when the middle part of a scene is deleted.

## Dividing a scene (AVCHD)



It is possible to divide an AVCHD scene.

Any unwanted parts in the scene can be deleted after dividing.

- Press the recording/playback button to switch this unit to the Playback Mode, and touch the play mode select icon. Then, select the AVCHD scene. (→ 24)

### 1 Select the menu.

**MENU** : [EDIT SCENE] → [DIVIDE] → [SET]

### 2 Touch and play back the scene you want to divide.

- It is convenient to use Slow-motion Playback and Frame-by-frame Playback. (→ 68)

### 3 Touch to set the dividing point.

- Touch [YES].
- Touch [YES] to continue dividing the same scene. To continue dividing other scenes, touch [NO] and repeat Steps 2-3.



### 4 Touch [Return] to complete dividing.

- Unwanted parts can be deleted. (→ 85)

#### To delete all the divided points

**MENU** : [EDIT SCENE] → [DIVIDE] → [CANCEL ALL]

- The scenes that were deleted after division cannot be recovered.

- You cannot divide a scene if the number of scenes of a given date would exceed 99 scenes.
- It may not be possible to divide scenes with a short recording time.
- Data that has been recorded or edited on another device cannot be divided and the divided points cannot be deleted.

## Dividing a scene to partially delete (MP4/iFrame)



Divide the MP4/iFrame scenes, and delete unnecessary parts.

This divides the recorded scenes in two and deletes the front half or back half.

**The scenes deleted by dividing cannot be restored.**

- Press the recording/playback button to switch this unit to the Playback Mode, and touch the play mode select icon. Then, select the MP4/iFrame scene. (→ 24)

### 1 Select the menu.

**MENU** : [EDIT SCENE] → [SPLIT&DELETE]

### 2 Touch and play back the scene you want to divide.

- It is convenient to use Slow-motion Playback and Frame-by-frame Playback. (→ 68)

### 3 Touch to set the dividing point.

- Set the dividing point so there will be 2 seconds or more for the part for deletion, and 3 seconds or more for the part to be kept.

### 4 Touch the part for deletion ([FRONT] or [BACK]).

### 5 Touch [YES] and confirm (play back) the part for deletion.

- A confirmation message appears when [NO] is touched. Proceed to Step 7.

### 6 Stop the playback.

- A confirmation message appears.

### 7 Touch [YES].

- To continue dividing and deleting other scenes, repeat Steps 2-7.

### To complete editing

Touch [Return].



- It may not be possible to divide scenes with a short recording time.
- The actual division may slightly slip off the previously designated dividing point.

## Protecting scenes/still pictures



Scenes/still pictures can be protected so that they are not deleted by mistake.

**(Even if you protect some scenes/still pictures, formatting the media will delete them.)**

- Press the recording/playback button to switch this unit to the Playback Mode.

### 1 Select the menu.

**MENU** : [VIDEO SETUP] or [PICT. SETUP] → [SCENE PROTECT]\*

\* [TRANSFER/PROTECT] is displayed when using the Eye-Fi card that is set as the selected transfer setting device in advance on the computer.

### 2 Touch the scene/still picture to be protected.

- When touched, the scene/still picture is selected and the  indication appears on the thumbnail. Touch the scene/still picture again to cancel the operation.
- Touch [Return] to complete the settings.



# Convert to MP4



Before copying, convert AVCHD or MP4 scenes to those with the image quality (MP4 (1280×720/30p) or MP4 (640×360/30p)) that supports playback on a PC or uploading on the internet.

- Scenes recorded in iFrame or saved as MP4 (640×360/30p) cannot be converted to MP4.

## 1 Select the menu.

[MENU] : [EDIT SCENE] → [CONVERT TO MP4]

## 2 Touch the scene you want to convert.

- The scene selection is made as you touch it, and the  indication appears on the thumbnail. To cancel the operation, touch the scene again.
- You can select up to 99 scenes in succession.

## 3 Touch [Enter].

## 4 Select the quality after conversion.

[HD (1280×720/30p)]\* : Convert to MP4 (1280×720/30p) and copy.

[VGA (640×360/30p)] : Convert to MP4 (640×360/30p) and copy.

\* You cannot convert and copy MP4 [720/30p] scenes.

- MP4 scenes after conversion are saved to the same media as the scenes before conversion.

## 5 Touch [YES].

- To continue converting scenes to MP4, repeat steps 2 to 5.

### To stop converting to MP4 halfway

Touch [CANCEL] during format conversion.

### To exit the MP4 conversion

Touch [Return].

- A scene recorded over a long time may take time.
- When converting and copying the scenes recorded in AVCHD to an MP4 scene, the scene exceeding approximately 20 minutes is automatically divided.
- If you convert protected scenes to MP4, their protection will be cleared after the conversion.

# Watching Video/Pictures on your TV



Confirm the terminals on your TV and use a cable compatible with the terminals. Image quality may vary with the connected terminals.

- A** High quality
- 1** HDMI terminal
- 2** Video terminal

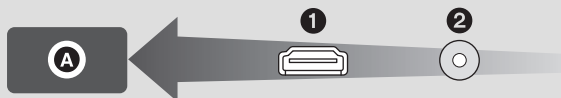

- Use the HDMI mini cable (supplied).
- HDMI is the interface for digital devices. If you connect this unit to an HDMI compatible high-definition TV and then play back the recorded high-definition images, you can enjoy them in high resolution with high quality sound.

## 1 Connect this unit to a TV.

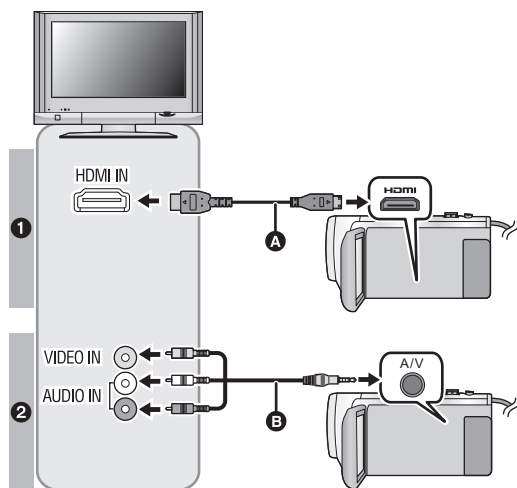

- A** HDMI mini cable (supplied)
- Be sure to connect to the HDMI terminal.
- Connecting with an HDMI mini cable (→ 92)
- Playback using VIERA Link (→ 93)
- B** Composite video cable (commercially-available)

### Picture quality

- 1** High-definition images when connecting to HDMI terminal
- 2** Standard images when connecting to video terminal

- Check that the plugs are inserted as far as they go.
- Always use the supplied HDMI mini cable or a genuine Panasonic HDMI mini cable (RP-CDHM15, RP-CDHM30: optional).

## 2 Select the video input on the TV.

- Example:
  - Select the [HDMI] channel with an HDMI mini cable.
  - Select the [Video 2] channel with a Composite video cable.  
(The name of the channel may differ depending on the connected TV.)
- Check the input setting (input switch) and the audio input setting on the TV. (For more information, please read the operating instructions for the TV.)

## 3 Change the mode to to play back.

---



- When this unit and the TV are connected with the HDMI mini cable (supplied) or a Composite video cable (commercially-available) in any of the following situations, no image will be displayed on the TV. Use LCD monitor of this unit.
  - Recording motion pictures
  - When setting PRE-REC
  - When saving the Highlight Playback scene or a manually edited scene
  - When performing [CONVERT TO MP4]
- If you connect this unit to the TV when this unit is set to Recording Mode, a squealing sound\* may be output. Before connecting this unit, set it to Playback Mode.
- \* The microphone may pick up the sound from the speakers, producing an abnormal sound.
- When connected to the TV, sound in Playback Mode is not output from this unit. Also, since the volume cannot be adjusted with this unit, adjust the volume of the TV.
- Some screens, such as the menu screen, may be displayed in reduced sizes on the TV.

■ **To watch images on a regular TV (4:3) or when both sides of the images do not appear on the screen**

Change the menu setting to display the images correctly. (Check the TV setting.)

**MENU** : [SETUP] → [TV ASPECT] → [4:3]

Example of images with a 16:9 aspect ratio on a regular TV (4:3)

[TV ASPECT] setting	
[16:9]	[4:3]
	

- If a wide-screen TV is connected, adjust the aspect setting on the TV. (Refer to the operating instructions of the TV for details.)

■ **To display the on-screen information on the TV**

When the menu setting is changed, the information displayed on the screen (operation icon etc.) can be displayed/not displayed on the TV.

**MENU** : [SETUP] → [EXT. DISPLAY] → desired setting

- [SIMPLE]\*: Information partially displayed
- [DETAIL]: Detailed information displayed
- [OFF]: Not displayed

\* This setting is only available in Motion Picture Recording Mode or Still Picture Recording Mode.

**Refer to the following support site for information about Panasonic TVs with an SD card slot for playing back your pictures.**

<http://panasonic.net/>

- It may not be possible to play back scenes on the TV depending on the [REC MODE].
- For details on how to play back, please read the operating instructions for the TV.

## Connecting with an HDMI mini cable

Select the desired method of HDMI output.

**MENU** : [SETUP] → [HDMI RESOLUTION] → [AUTO]/[1080p]/[1080i]/[480p]

- [AUTO] determines the output resolution automatically based on information from the connected TV.  
If the images are not output on the TV when the setting is [AUTO], switch to the method [1080p], [1080i] or [480p] which enables the images to be displayed on your TV. (Please read the operating instructions for the TV.)
- Images may not be displayed on the television for several seconds in some cases, such as when changing between scenes.

# Playback using VIERA Link



## What is the VIERA Link (HDAVI Control™)?

- VIERA Link™ is a new name for EZ Sync™.
- This function allows you to use your remote control for the Panasonic TV for easy operations when this unit has been connected to a VIERA Link compatible device using an HDMI mini cable (supplied) for automatic linked operations. (Not all operations are possible.)
- VIERA Link is a unique Panasonic function built on an HDMI control function using the standard HDMI CEC (Consumer Electronics Control) specification. Linked operations with HDMI CEC compatible devices made by other companies are not guaranteed. When using devices made by other companies that are compatible with VIERA Link, refer to the operating instructions for the respective devices.
- This unit supports "VIERA Link Ver.5" function. "VIERA Link Ver.5" is the standard for Panasonic's VIERA Link compatible equipment. This standard is compatible with Panasonic's conventional VIERA Link equipment.

◇ **Press the recording/playback button to switch this unit to the Playback Mode.**

**1** Select the menu.

**MENU** : [SETUP] → [VIERA Link] → [ON]

- If you are not using VIERA Link, set to [OFF].

**2** **Connect this unit to a Panasonic TV compatible with VIERA Link with an HDMI mini cable. (→ 90)**

- It is recommended to connect this unit to an HDMI terminal other than the HDMI1 if there are 2 or more HDMI input terminals on the TV.
- VIERA Link must be activated on the connected TV. (Read the operating instructions of the TV for how to set etc.)

### 3 Operate with the remote control for the TV.

- You can select the scene or picture you want to play back by pressing the button up, down, left or right, and then the button in the center.

(When selecting scenes)

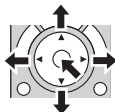

(When playing back)

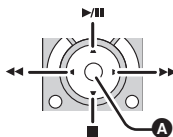

**A** Display/Cancel operation icons

- The following operations are available by pressing the color buttons on the remote control.

Green	<ul style="list-style-type: none"><li>• Switching the number of scenes/still pictures in thumbnail display (9 thumbnails → 20 thumbnails → 9 thumbnails...)</li><li>• Zoom in on still picture</li></ul>
Yellow	<ul style="list-style-type: none"><li>• Deleting scenes/still pictures</li></ul>
Red	<ul style="list-style-type: none"><li>• Zoom out from still picture</li></ul>

#### ■ Other linked operations

##### Turning the unit off:

If you use the remote control for the TV to turn off the power, this unit also turns off.

##### Automatic input switching:

If you connect with an HDMI mini cable and then turn on this unit, the input channel on the TV automatically switches to this unit's screen. If the TV's power is in standby status, it will turn on automatically (if [Set] has been selected for the TV's [Power on link] setting).

- Depending on the HDMI terminal on the TV, the input channel may not switch automatically. In this case, use the remote control for the TV to switch the input channel.

- 
- If you are unsure whether or not the TV and AV amplifier you are using are compatible with VIERA Link, read the operating instructions for the devices.
  - Available linked operations between this unit and a Panasonic TV is different depending on the types of Panasonic TVs even if they are compatible with VIERA Link. Refer to the operating instructions of the TV for the operations that support on the TV.
  - Operation is not possible with a cable that is not based on the HDMI standard.

## Copying/playing back with a USB HDD



- In this Owner's Manual, "USB hard disk drive" is indicated as "USB HDD".
- If you connect a USB HDD (commercially-available) to this unit by using a USB Connection Cable (commercially-available), you can copy motion pictures and still pictures recorded on this unit to a USB HDD.
- It can also play back the scenes and still pictures copied to the USB HDD.
- You can copy scenes and still pictures recorded with this unit while maintaining the image quality.
- Please read the operating instructions of the USB HDD for how to use it.

### Preparing for copying/playing back

Refer to the following support site for information about USB HDD.

[http://panasonic.jp/support/global/cs/e\\_cam](http://panasonic.jp/support/global/cs/e_cam)

(This Site is English only)

When the USB HDD that requires formatting is connected, a message is displayed. Follow the instructions on the screen to format it.

Once the USB HDD has been formatted, all data stored on it will be deleted. The data cannot be recovered.

- In the following cases, a USB HDD cannot be used by connecting it to this unit:
  - A USB HDD with a capacity of below 160 GB or above 2 TB
  - When a USB HDD has two or more partitions
  - If a USB HDD is in a format other than FAT32
  - When connected by using a USB hub

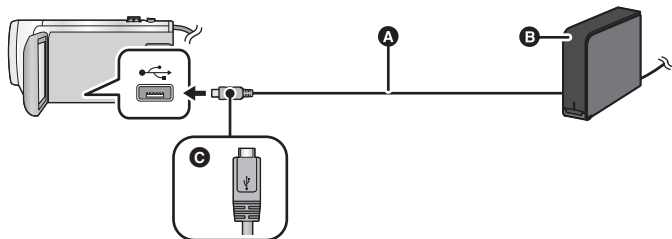

- **A** USB Connection Cable (commercially-available)
- **B** USB HDD (commercially-available)
- **C** Turn the side with the symbol up to connect the micro A end of the USB Connection Cable to the USB terminal of this unit.
- Connect this unit to the AC adaptor

**1** (When using a desktop HDD)

**Connect the AC adaptor (supplied with USB HDD) to the USB HDD.**

- If you are using a bus-powered or portable USB HDD, this unit can supply power to the USB HDD by USB Connection Cable (commercially-available).

## 2 Connect the AC adaptor and a sufficiently charged battery to this unit.

- If the AC adaptor is not connected to this unit, the USB HDD cannot be used.

## 3 Turn on this unit, and press the recording/playback button to switch this unit to the Playback Mode.

## 4 Connect this unit to the USB HDD with the USB Connection Cable (commercially-available).

- Use a USB Connection Cable (commercially-available) compatible with the USB terminals of this unit and the USB HDD. Connect the micro A end of the USB Connection Cable to the USB terminal of this unit. For information on the USB terminal of the USB HDD, refer to the operating instructions of the USB HDD.
- It may take several minutes until the connection is completed.

## 5 Touch the desired item.

<b>[Simple copy]:</b>	Copies all scenes and still pictures recorded with this unit that have not been copied yet. (→ 97)
<b>[Copy selected files]:</b>	Allows you to select desired scenes/still pictures, and then copy. (→ 98)
<b>[Playback HDD]:</b>	Plays back scenes and still pictures stored in a USB HDD on this unit. (→ 99)
<b>[Safe Removal]:</b>	Allows you to safely remove this unit and a USB HDD.

- Following can be performed by connecting the USB HDD with the scenes and still pictures copied from this unit to other devices.
  - Save on a PC or rewrite on USB HDD using HD Writer LE 3.0

When the USB HDD is connected to other devices such as Blu-ray disc recorder, a message prompting to format the USB HDD may display. All the scenes and still pictures recorded on the USB HDD will be erased if formatted. Do not format as important data will get erased and it will be impossible to restore.

- When using an Eye-Fi card (commercially-available), set [Eye-Fi TRANSFER] to [OFF]. (→ 104)  
When the item is set to [ON], even if you connect the USB HDD to this unit, it will not recognize the USB HDD.

### ■ Points to check before copying

- **When using a USB HDD for the first time, or using a USB HDD that has been used with other devices, first run [FORMAT MEDIA].**
- Before copying, go to [MEDIA STATUS] to check the amount of free space on the USB HDD.
- In the following cases, copying may take longer:
  - There are lots of scenes
  - The temperature of this unit is high
- If you copy protected scenes or still pictures, the protection setting of the copied scenes or still pictures are canceled.
- The order in which the scenes were copied cannot be changed.

**Before you delete the data on the media after copying is complete, be sure to play back the USB HDD to check that they have been copied to correctly. (→ 99)**



## ■ Formatting

This is for initializing the USB HDD.

- **Please be aware that if a media is formatted then all the data recorded on the media is erased and cannot be recovered. Back up important data on a PC etc.**
- **Connect this unit to the USB HDD and touch [Playback HDD]**

**MENU** : [SETUP] → [FORMAT MEDIA] → [HDD]

- When formatting is complete, touch [EXIT] to exit the message screen.
- Connect this unit and the USB HDD to format.  
You may no longer be able to use the USB HDD if you format them on another device such as a PC etc.

## ■ Displaying media information

The used space of the USB HDD can be checked.

- **Connect this unit to the USB HDD and touch [Playback HDD]**

**MENU** : [SETUP] → [MEDIA STATUS]

- If you touch [CHANGE MEDIA], you can switch the display between the SD card and USB HDD.

## Simple copy

---

**1** Connect this unit to the USB HDD to prepare for copying. (→ 95)

**2** Touch [Simple copy].

- When [Copy selected files] or [Playback HDD] is selected, terminate the connection with the USB HDD (→ 99), and then perform the operation of Step 1.

**3** Touch [YES].

**4** Touch [EXIT] when the copy complete message is displayed.

- The thumbnail view of the copy destination is indicated.

**When you stop copying halfway:**

Touch [CANCEL] while copying.

## Copy selected files

---



**1** Connect this unit to the USB HDD to prepare for copying. (→ 95)

**2** Touch [Copy selected files].

- You can also copy scenes or still pictures by touching , selecting [COPY].

**3** Touch [NEXT].

**4** Touch the desired items following the instructions on the screen.

- It will return to the previous step by touching .
- (When [SELECT SCENES] is selected)  
When touched, the scene/still picture is selected and the  indication appears on the thumbnail. Touch the scene/still picture again to cancel the operation.
- (When [SELECT DATE] is selected)  
When touched, the date is selected and surrounded by red. Touch the date again to cancel the operation.
- Up to 99 scenes/ 99 dates can be selected continuously.

**5** Touch [EXIT] when the copy complete message is displayed.

- The thumbnail view of the copy destination is indicated.

**When you stop copying halfway:**

Touch [CANCEL] while copying.

# Playing back the USB HDD

- Only motion picture/still picture that have been copied by connecting this unit to the USB HDD or copied with HD Writer LE 3.0 can be played back.

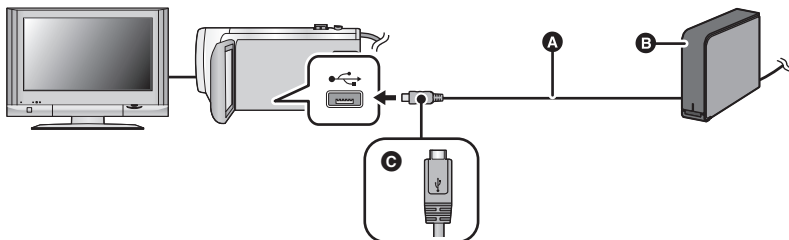

- A** USB Connection Cable (commercially-available)
- B** USB HDD (commercially-available)
- C** Turn the side with the symbol up to connect the micro A end of the USB Connection Cable to the USB terminal of this unit.

## 1 Connect this unit to the USB HDD to prepare for playback. (→ 95)

- When playing back on a TV, connect this unit to the TV. (→ 90)

## 2 Touch [Playback HDD].

## 3 Touch the scene or still picture to be played back and then play it back.



- The playback operation is performed the same as when playing back motion pictures or still pictures. (→ 24, 68)

### To terminate the connection between this unit and the USB HDD

Touch  on the Touch Menu.

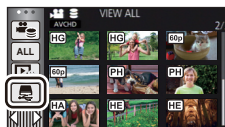
- Disconnect the USB Connection Cable from this unit.





- It is also possible to switch the media to play back by touching the play mode select icon. When the USB HDD is connected, the  (USB HDD) can be selected from the displayed media types. (→ 24)
- The scenes you have saved in Highlight Playback during playback of the USB HDD are saved in the SD card.
- Deleting scenes and still pictures on the USB HDD may take time.
- You cannot set the following items during playback of  (USB HDD).
  - [SCENE PROTECT]
  - [SECTION DELETE]
  - [DIVIDE]
  - [MANUAL EDIT]
  - [SPLIT&DELETE]
  - [CONVERT TO MP4]

## Dubbing with a Blu-ray disc recorder, video device, etc.

- Blu-ray recorders are not sold in US.

### ■ Check before dubbing

Check the equipment used for dubbing.

Equipment used for dubbing	Dubbing picture quality	To dub
Equipment with SD card slot	<b>High-definition picture quality*</b>	Insert the SD card directly (→ 101) 
Equipment with USB terminal	<b>High-definition picture quality*</b>	Connect with supplied USB cable (→ 101) 
Equipment without SD card slot or USB terminal	<b>Standard picture quality</b> This can be played back on equipment incompatible with high-definition (AVCHD), so it is convenient if you are dubbing for distribution.	Connect with Composite video cable (commercially-available) (→ 103) 

\* Some equipment may not be compatible with high-definition (AVCHD) or MP4 (iFrame) picture quality. In such a case, connect with the Composite video cable (commercially-available) and dub with standard picture quality. (→ 103)

- For the positions of the SD card slot, USB terminal, or terminal for connecting the Composite video cable, refer to the operating instructions of the equipment used.

**You can dub scenes recorded with this unit to a Panasonic Blu-ray disc recorder or DVD recorder that supports the recording format or recording mode you want to use.**

- **Note that the equipment described may not be available in certain countries and regions.**



### ■ To dub using equipment with an SD card slot

You can dub by directly inserting an SD card.

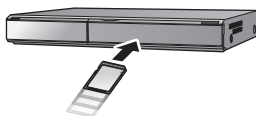

### ■ To dub using equipment with a USB terminal

You can dub by connecting a USB cable.

- Use the AC adaptor to free you from worrying about the battery running down.
- Turn on the unit.

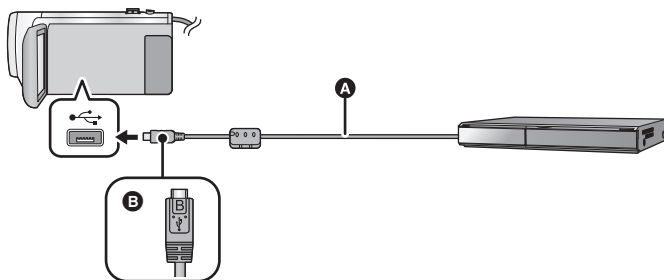

- A** USB cable (supplied)
  - B** Turn the side with the symbol up to connect the micro B end of the USB Cable to the USB terminal of this unit.
- Insert the plugs as far as they will go.

### 1 Connect the unit to the Blu-ray disc recorder or high-definition (AVCHD) compatible DVD recorder.

- The USB function selection screen will appear on the screen of the unit.

### 2 Touch [RECORDER] on the screen of this unit.

- When you select an option other than [RECORDER], reconnect the USB cable.
- When using the battery, the LCD monitor turns off after about 5 seconds. Touch the screen to turn the LCD monitor on.

### 3 Dubbing through operations on the Blu-ray disc recorder or high-definition (AVCHD) compatible DVD recorder.

#### About the screen indication of the unit

- When the unit is accessing the SD card, card access icon (  ) appears on the unit screen or the access lamp is on.
- Be careful not to disconnect the USB cable, AC adaptor or battery while the unit is accessing the media, as this may result in the loss of recorded content.

- 
- Do not use any other USB cables except the supplied one. (Operation is not guaranteed with any other USB cables.)
  - When this unit is connected to a Panasonic Blu-ray disc recorder or a DVD recorder using a USB cable while the unit is turned on, power is also supplied from the connected equipment to this unit.
  - For details on dubbing and playback methods, read the operating instructions of the Blu-ray disc recorder or DVD recorder.
  - When you connect the unit to a Blu-ray disc recorder, a dubbing operations screen may appear on the television connected to the Blu-ray disc recorder. In this case as well, perform the operations of Steps 1 to 3.
  - You cannot switch the Recording Mode/Playback Mode by pressing the recording/playback button on this unit while the Blu-ray disc recorder or DVD recorder is connected. Disconnect the USB cable before performing either of these operations.
  - If the battery runs down during dubbing, a message will appear. Operate the Blu-ray disc recorder to cancel the dubbing.



### ■ Dubbing using equipment without an SD card slot or a USB terminal, or using a video device

You can dub by connecting a Composite video cable (commercially-available).

- Use the AC adaptor to free you from worrying about the battery running down.

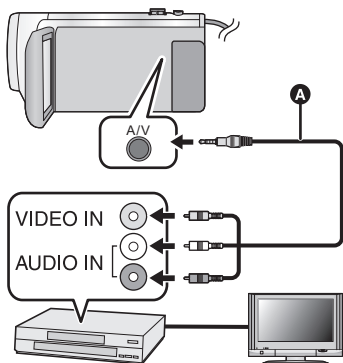

#### Change the video input on the video device and TV that this unit is connected to.

- The channel set will differ depending on the terminal to which the unit is connected.
- See the operating instructions of the video device for details.
- Insert the plugs as far as they will go.
- **A** Composite video cable (commercially-available)

- Press the recording/playback button to switch this unit to the Playback Mode.

**1** Connect this unit to a video device and start playback on this unit.

**2** Start recording on the connected device.

- To stop recording (dubbing), stop playback on this unit after stopping recording on the recorder.

- Some screens, such as the menu screen, may be displayed in reduced sizes on the TV.
- If the date and time display and function indication are not wanted, cancel them before dubbing. (→ 30, 92)

If the dubbed images are played back on a wide-screen TV, the images may be stretched vertically.

In this case, refer to the operating instruction for the device you are connecting to or read the operating instructions of the wide-screen TV and set the aspect ratio to 16:9.

## Using the Eye-Fi™ card

Using an Eye-Fi card (commercially-available), you can record motion pictures and still pictures on the card, and save them on a PC or upload them on a file-sharing website via a wireless network.



- The functions of the Eye-Fi card (including wireless transmission) are not guaranteed to work on this product. In the case of a malfunction of the card, please contact the card manufacturer.
- To use the Eye-Fi transfer feature, a broadband wireless LAN environment is required.
- To use the Eye-Fi card, permission from the national or regional government is required. Do not use if you have not obtained permission. If you are unsure as to whether use is permitted, please check with the card manufacturer.
- To prevent the interception of communications, misuses, identity thefts, etc., we strongly recommend you configure the appropriate security settings (encryption settings). For details, refer to the manuals of your Eye-Fi card and access point.
- **Install the software supplied with the Eye-Fi card in advance on your PC, and configure the Eye-Fi settings. (For settings methods etc., please read the card operating instructions or consult the card manufacturer)**

- **Insert an Eye-Fi card (commercially available) to the unit.**

### Select the menu.

**MENU** : [SETUP] → [Eye-Fi TRANSFER] → [ON]

- When [Eye-Fi TRANSFER] is set to [ON], the transferable files will be transferred automatically.
- To cancel the transferring of a file, turn off the unit or set [Eye-Fi TRANSFER] to [OFF].
- The setting at the time of purchase is [OFF]. Every time the Eye-Fi card is removed from the unit, this setting is set to [OFF].
- Eye-Fi transfers are not available during motion picture recording.
- You can check the file transfer status on the thumbnail screen.

	File has been transferred
	File waiting for transfer
	File cannot be transferred



## ■ Using Eye-Fi direct mode

The files can be transferred directly from the Eye-Fi card to a smartphone without going through the wireless access point when necessary setting is performed in a PC in advance.

- **Install the software supplied with the Eye-Fi card on your PC, and configure the Eye-Fi direct mode settings.**
- **Insert an Eye-Fi card (commercially available) to the unit.**

Select the menu.

**MENU** : [SETUP] → [Eye-Fi DIRECT]

- This mode is displayed only when [Eye-Fi TRANSFER] is set to [ON].
- The mode will be canceled using the following steps.
  - When the unit is turned off
  - If you start recording motion pictureIn addition to the steps above, the mode may also be canceled by the Eye-Fi card.
- When connected via Eye-Fi direct mode, [ECONOMY (BATT)]/[ECONOMY (AC)] are disabled.

## ■ Selecting files to transfer



If you perform the required settings in advance on your PC, you can transfer selected files alone. For settings methods etc., please read the card operating instructions or consult the card manufacturer.

- **Install the software supplied with the Eye-Fi card on your PC, and configure the selection transfer settings.**
- **Insert an Eye-Fi card (commercially available) to the unit.**
- 1 Press the recording/playback button to switch to the Playback Mode.**
- 2 Touch the play mode select icon.**
- 3 Select [MP4/iFrame] or [PICTURE]. (→ 24)**
- AVCHD scenes cannot be used as the selected transfer setting.
- 4 Select the menu.**

**MENU** : [VIDEO SETUP] or [PICT. SETUP] → [TRANSFER/PROTECT]

- The setting method is the same as that for the scene protect settings. (→ 88)
- If the selected transfer setting is not configured on the computer, [SCENE PROTECT] is displayed and the selected transfer setting cannot be configured.
- When the write protect switch on the Eye-Fi card is on the LOCK side, [SCENE PROTECT] is displayed and selected transfer setting is disabled. Please unlock the write protect switch.
- The protect setting is also applied to the files for which [TRANSFER/PROTECT] is set. To delete a file, first cancel [TRANSFER/PROTECT] and then perform the operation.

- The Eye-Fi menu only appears when an Eye-Fi card is used.
- The Eye-Fi transfer feature cannot be guaranteed to continue to operate in the future due to changes to the card specification etc.
- Update the firmware of the Eye-Fi card to the latest one using the software supplied with the Eye-Fi card before use.
- When the endless memory function of the Eye-Fi card is set to on, the files transferred from the card may be deleted automatically.
- The Eye-Fi card may heat up as a result of the files being transferred. Note that the use of an Eye-Fi card accelerates the battery drain, so we recommend you use the card in Playback Mode.
- The Eye-Fi setting can be checked while pausing the recording.

	<b>[Eye-Fi TRANSFER] is set to [ON] (Transferring in Eye-Fi direct mode)</b>
	<b>[Eye-Fi TRANSFER] is set to [ON]</b>
	<b>[Eye-Fi TRANSFER] is set to [OFF]</b>

- If the Eye-Fi card is removed and then reinserted into the unit, set functions related to Eye-Fi again from the menu.
- When using the Eye-Fi card, please be sure to unlock the write-protect switch. (→ 12)
- Before deleting the files, please confirm they have been transferred to your PC and uploaded to the sharing site.
- Do not use the Eye-Fi card in locations where the use of wireless devices is forbidden, such as inside aircraft etc.
- Depending on network conditions, the transfer may take some time. Also, if network conditions deteriorate, the transfer may be suspended.
- Files over 2 GB in size cannot be transferred. Such files should first be split to reduce the file size. (→ 87)

# What you can do with a PC

## HD Writer LE 3.0

You can copy the motion/still picture data to the HDD of PCs or write to media like Blu-ray discs, DVD discs or SD cards using HD Writer LE 3.0.

Check the website below to download/install the software.

- The software is available for download until the end of March 2019.  
[http://panasonic.jp/support/global/cs/soft/download/f\\_le30.html](http://panasonic.jp/support/global/cs/soft/download/f_le30.html)

- Refer to the operating instructions of HD Writer LE 3.0 (PDF file) for details on how to use it.  
 (→ 117)

## ■ Smart Wizard

The Smart Wizard Screen is automatically displayed when you connect this unit to a PC with HD Writer LE 3.0 installed. (→ 114)



### Copy to PC:

You can copy motion/still picture data to the HDD of PCs.

### Copy to disc:

You can copy to disc in high-definition picture quality.

- Select the function you wish to use and follow the on-screen instructions for easy copying.

What can be done with the HD Writer LE 3.0	Data type
<b>Copying data to a PC</b>	Motion picture and still picture
<b>Copying in Blu-ray disc/AVCHD format:</b> <ul style="list-style-type: none"> <li>• The scenes recorded in 1080/60p can be copied as 1080/60p.                      (→ 108: Important Notice)</li> <li>• MP4/iFrame scenes cannot be copied in Blu-ray disc or in AVCHD format.</li> </ul>	
<b>Editing:</b> Editing motion picture data copied on an HDD of a PC <ul style="list-style-type: none"> <li>• Dividing, Trimming, Still picture, Title, Effect, Transition, BGM, Delete partially</li> <li>• Converting part of motion picture into still picture</li> </ul>	Motion picture
<b>Online sharing:</b> You can upload motion pictures on the Internet and share them with your family and friends.	
<b>Playing back on a PC:</b> Play back the motion picture and still picture data in high-definition picture quality on a PC.	Motion picture and still picture
<b>Formatting discs:</b> Depending on the type of disc that you use, formatting is necessary.	Motion picture

- It is possible to play back still pictures on a PC using an image viewer standard to Windows or commercially available image browsing software, and copy still pictures to a PC using Windows Explorer.
- Please refer to page 118 for details about using a Mac.

### **Important Notice**

- When using an SDXC Memory Card, check the following support site.  
<http://panasonic.net/avc/sdcard/information/SDXC.html>
- Do not insert a disc recorded in AVCHD format with HD Writer LE 3.0 in a device that does not support the AVCHD format. In some cases the disc may get stuck in the device.
- To play back a Blu-ray disc to which you have copied scenes recorded in 1080/60p, equipment is required that supports AVCHD Progressive.
- When inserting a disc containing recorded motion pictures into other devices, a message prompting you to format the disc may be displayed. Do not format the disc, since deleted data cannot be restored later.

- 
- It is impossible to write data to this unit from a PC.
  - Motion pictures that have been recorded on another device cannot be written to the HD Writer LE 3.0.
  - When motion picture data is written to and read from the SD card, correct operation of the unit cannot be guaranteed if software other than HD Writer LE 3.0 is used.
  - Do not start the HD Writer LE 3.0 and other software at the same time.

# Before Installing HD Writer LE 3.0

---

Your installation or use of the Software defined below shall be conclusively deemed to constitute your acceptance of the terms of this Agreement. If you do not accept the terms of this Agreement, do not install, nor use the Software.

## End User License Agreement

You ("Licensee") are granted a license for the Software defined in this End User License Agreement ("Agreement") on condition that you agree to the terms and conditions of this Agreement.

The following terms contain material representations regarding the disclaimers of Panasonic Corporation. Be sure to read through, understand and confirm the following terms.

### Article 1 License

Licensee is granted the right to use the Software (the "Software" means the Software and other information such as manuals downloaded by Licensee through Panasonic website), but all applicable rights to patents, copyrights, trademarks and trade secrets in the Software are not transferred to Licensee.

### Article 2 Use by a Third Party

Licensee may not use, copy, modify, transfer, rent, lease, lend or allow any third party, whether free of charge or not, to use, copy or modify the Software, except as expressly provided for in this Agreement.

### Article 3 Restrictions on Copying the Software

Licensee may make a single copy of the Software in whole or a part solely for back-up purpose.

### Article 4 Computer

Licensee may use the Software only on one computer, and may not use it on more than one computer. Further, Licensee may not use the Software for commercial software hosting services.

### Article 5 Reverse Engineering, Decompiling or Disassembly

Licensee may not reverse engineer, decompile, or disassemble the Software, except to the extent either of them is permitted under law or regulation of the country where Licensee resides. Panasonic, or its distributors will not be responsible for any defects in the Software or damage to Licensee caused by Licensee's reverse engineering, decompiling, or disassembly of the Software.

### Article 6 Indemnification

The Software is provided "AS-IS" without warranty of any kind, either expressed or implied, including, but not limited to, warranties of non-infringement, merchantability and/or fitness for a particular purpose. Further, Panasonic does not warrant that the operation of the Software will be uninterrupted or error free. Panasonic or any of its distributors will not be liable for any damage suffered by Licensee arising from or in connection with Licensee's use of the Software.

### Article 7 Export Control

Licensee agrees not to export or re-export to any country the Software in any form without the appropriate export licenses under regulations of the country where Licensee resides, if necessary.

### Article 8 Termination of License

The right granted to Licensee hereunder will be automatically terminated if Licensee contravenes any of the terms and conditions of this Agreement. In this event, Licensee must destroy the Software and related documentation together with all the copies thereof at Licensee's own expense.

Article 9 With regard to MICROSOFT SQL SERVER COMPACT 3.5 produced by Microsoft Corporation

(1) Licensee shall use the MICROSOFT SQL SERVER COMPACT 3.5 only when included in the Software, and shall not use the MICROSOFT SQL SERVER COMPACT 3.5 in any other configuration or method. Licensee shall not publish the MICROSOFT SQL SERVER COMPACT 3.5 or work around any technical limitations in the MICROSOFT SQL SERVER COMPACT 3.5.

(2) Licensee shall not use, copy, distribute, regrant for use or otherwise handle the Software in any way beyond the range of use granted under Article 9 (1), and shall not conduct operations such as reverse engineering, decompilation, disassembling, etc. of the MICROSOFT SQL SERVER COMPACT 3.5.

(3) All rights, including copyright, patent rights etc. relating to the MICROSOFT SQL SERVER COMPACT 3.5 shall belong to Microsoft Corporation. Licensee shall not claim any rights related to the MICROSOFT SQL SERVER COMPACT 3.5 whatsoever.

# Operating environment

- Even if the system requirements mentioned in these operating instructions are fulfilled, some PCs cannot be used.
- A compatible Blu-ray disc/DVD writer drive and media are necessary for writing to a Blu-ray disc/DVD.
- Operation is not guaranteed in the following cases.
  - When 2 or more USB devices are connected to a PC, or when devices are connected through USB hubs or by using extension cables.
  - Operation on an upgraded OS.
  - Operation on an OS other than the one pre-installed.
- This software is not compatible with Microsoft Windows 3.1, Windows 95, Windows 98, Windows 98SE, Windows Me, Windows NT, Windows 2000 and Windows XP.

## ■ Operating environment for HD Writer LE 3.0

<b>OS*</b>	Windows 8/Windows 8.1 (32 bit/64 bit) Windows 7 (32 bit/64 bit) SP1 Windows Vista (32 bit) SP2
<b>CPU</b>	Intel Pentium 4 2.8 GHz or higher (including compatible CPU) <ul style="list-style-type: none"> <li>• Intel Core 2 Duo 2.16 GHz or higher or AMD Athlon 64 X2 Dual-Core 5200+ or higher is recommended when using playback function.</li> <li>• Intel Core 2 Quad 2.6 GHz or higher is recommended when using editing function.</li> <li>• Intel Core i7 2.8 GHz or higher is recommended when using playback or editing function for 1080/60p.</li> </ul>
<b>RAM</b>	Windows 7/Windows 8/Windows 8.1: 2 GB or more (64 bit)/1 GB or more (32 bit) Windows Vista: 1 GB or more
<b>Display</b>	High Color (16 bit) or more (32 bit or more recommended) Desktop resolution of 1024×768 pixels or more (1920×1080 pixels or more recommended) Graphics card complying with DirectX 9.0c (DirectX 10 recommended) and DirectDraw overlay PCI Express™ x16 compatible recommended Video memory of 256 MB or more recommended
<b>Free hard disk drive space</b>	Ultra DMA — 100 or more 450 MB or more (for installing the software) <ul style="list-style-type: none"> <li>• If the compression setting is enabled, errors will occur during recording. Clear the check box for [Compress this drive to save disk space] in [Properties] for the hard disk drive.</li> </ul>
<b>Sound</b>	DirectSound Support
<b>Interface</b>	USB port
<b>Other requirements</b>	Mouse or equivalent pointing device Internet connection

\* Also confirmed to work with Windows 10.

- This software is only for Windows.
- Input is not supported in languages other than English, German, French, Simplified Chinese and Russian.
- Operation cannot be guaranteed on all Blu-ray disc/DVD drives.
- Operation is not guaranteed on Windows Vista Enterprise, Windows 7 Enterprise, Windows 8 Enterprise, Windows 8.1 Enterprise or Windows RT.
- For Windows 8/Windows 8.1, this software is available only as a desktop application.
- This software is not compatible with a multi-boot environment.
- This software is not compatible with a multi-monitor environment.
- If using Windows Vista/Windows 7/Windows 8/Windows 8.1, administrative account and standard account users only can use this software. (An administrative account user should install and uninstall this software.)

### ■ To use the HD Writer LE 3.0

You will need a high performance PC depending on the functions to be used. It may not properly play back or properly operate depending on the environment of the PC used. Refer to the operating environment and notes.

- Operation during the playback may become slow if the CPU or memory is not fulfilling the requirements of the operating environment.
- Always use the most current driver for the video card.
- Always make sure there is enough capacity on the HDD in the PC. It may become inoperable or the operation may stop suddenly if the capacity gets low.

### ■ Operating environment for the card reader function (mass storage)

<b>OS</b>	Windows 10 (32 bit/64 bit) Windows 8/Windows 8.1 (32 bit/64 bit) Windows 7 (32 bit/64 bit) SP1 Windows Vista (32 bit) SP2
<b>CPU</b>	1 GHz or higher 32-bit (x86) or 64-bit (x64) processor
<b>RAM</b>	Windows 7/Windows 8/Windows 8.1/Windows 10: 2 GB or more (64 bit)/1 GB or more (32 bit) Windows Vista Home Basic: 512 MB or more Windows Vista Home Premium/Business/Ultimate/Enterprise: 1 GB or more
<b>Interface</b>	USB port
<b>Other requirements</b>	Mouse or equivalent pointing device

- The USB equipment operates with the driver installed as standard in the OS.



# Installation

When installing the software, log on to your computer as the Administrator or with a user name with equivalent authorization. (If you do not have authorization to do this, consult your manager.)

- Before starting the installation, close all applications that are running.
- Do not perform any other operations on your PC while the software is being installed.
- Explanation of operations is based on Windows 7.

## ■ Installing HD Writer LE 3.0

Check the website below to download/install the software.

- The software is available for download until the end of March 2019.  
[http://panasonic.jp/support/global/cs/soft/download/f\\_le30.html](http://panasonic.jp/support/global/cs/soft/download/f_le30.html)

## ■ Uninstalling HD Writer LE 3.0

Follow the steps below to uninstall any software applications that you no longer require.

- 1 Select **[Start]** → **[Control Panel]** → **[Uninstall a Program]**.
  - 2 Select **[HD Writer LE 3.0]**, then click **[Uninstall]**.
- Proceed with the uninstallation by following the on-screen instructions.
  - After uninstalling the software, be sure to reboot the PC.

# Connecting to a PC

- Connect this unit to the PC after the software applications are installed.

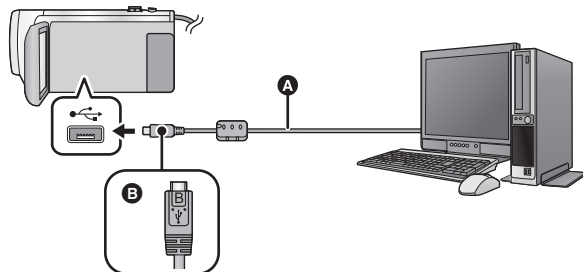

- A** USB cable (supplied)
  - B** Turn the side with the symbol up to connect the micro B end of the USB Cable to the USB terminal of this unit.
- Insert the plugs as far as they will go.

## 1 Connect this unit to the AC adaptor.

- Use the AC adaptor to free you from worrying about the battery running down.

## 2 Turn on the unit.

## 3 Connect this unit to a PC.

- The USB function selection screen will appear.

## 4 Touch [PC] on the screen of this unit.

- The Smart Wizard Screen is automatically displayed when HD Writer LE 3.0 is installed.
- This unit is automatically recognized as an external drive of the PC. (→ 116)
- When you select an option other than [PC], reconnect the USB cable.
- When using the battery, the LCD monitor turns off after about 5 seconds. Touch the screen to turn the LCD monitor on.

- 
- Do not use any other USB cables except the supplied one. (Operation is not guaranteed with any other USB cables.)
  - When this unit is connected to a PC using a USB cable while the unit is turned on, power is also supplied from the PC to this unit.
  - When performing reading/writing between a PC and an SD card, be aware that some SD card slots built into PCs and some SD card readers are not compatible with the SDHC Memory Card or SDXC Memory Card.
  - When using an SDXC Memory Card, check the following support site.  
<http://panasonic.net/avc/sdcard/information/SDXC.html>

## ■ To disconnect USB cable safely

Select the  icon in task tray displayed on the PC, and then select the model number of this unit to disconnect the USB cable.

- Depending on your PC's settings, this icon may not be displayed.

### About the screen indication of the unit

- Do not disconnect the USB cable, battery, or AC adaptor while the access lamp is on or card access icon (  ) appears on the unit screen.
- If the screen does not change when the unit is operated while connected to a PC, disconnect the battery and/or AC adaptor, wait approximately 1 minute, reconnect the battery and/or AC adaptor, wait approximately 1 minute again, and then turn the unit back on. (Data may be destroyed when above operation is performed while accessing the SD card.)

## ■ Charging the battery by connecting it to different devices

When using the battery, if you turn off the unit and connect it to a PC, Panasonic Blu-ray disc recorder or Panasonic DVD recorder, the battery will charge.

- **When connecting this unit to a PC for the first time, make sure to connect this unit to the PC with this unit turned on.**
- Insert the USB cable securely all the way. It will not operate properly if it is not inserted all the way.
- Do not use any other USB cables except the supplied one. (Operation is not guaranteed with any other USB cables.)
- You cannot charge the battery by connecting the supplied DC cable.
- Be sure to connect the unit directly to the PC, Blu-ray disc recorder or DVD recorder.
- During charging, the status indicator flashes.
- You cannot charge when the status indicator flashes rapidly, or when it does not light at all. Charge using the AC adaptor. (→ 10)
- It will take 2 or 3 times longer to charge compared to when using the AC adaptor.
- If the status indicator flashes at a particularly fast or slow rate, refer to page 130.

## About the PC display

When the unit is connected to a PC, it is recognized as an external drive.

- Removable disk (Example:  CAM\_SD (F:) ) is displayed in [Computer].

We recommend using HD Writer LE 3.0 to copy motion picture data.

Using Windows Explorer or other programs on the PC to copy, move or rename files and folders recorded with this unit will result in them being unusable with HD Writer LE 3.0. It is impossible to write data to SD card on this unit from a PC.

### Example folder structure of an SD card:

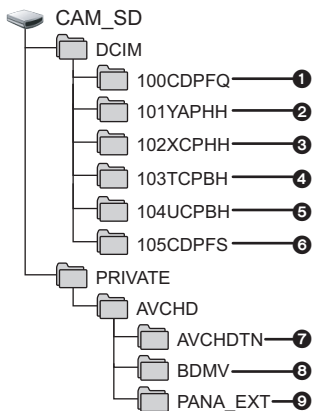

The following data will be recorded.

- 1 Up to 999 still pictures in JPEG format ([S1000001.JPG] etc.)
- 2 MP4 format (1080/60p) motion picture files ([S1000001.MP4] etc.)
- 3 MP4 format (720/30p) motion picture files ([S1000001.MP4] etc.)
- 4 MP4 format (360/30p) motion picture files ([S1000001.MP4] etc.)
- 5 iFrame format motion picture files ([S1000001.MP4] etc.)
- 6 JPEG format still pictures created from the motion picture
- 7 The motion picture thumbnails
- 8 AVCHD format motion picture files ([00000.MTS] etc.)
- 9 For management

### ■ Copying your still pictures to your PC

#### Card reader function (mass storage)

Still pictures recorded with this unit can be copied to the PC with Explorer or other programs.

- 1 Double-click the folder that contains the still pictures. ([DCIM] → [100CDPFQ] etc.)
- 2 Drag and drop the still pictures onto the destination folder (on the PC's HDD).

- Do not delete the SD card's folders. Doing so may make the SD card unusable in this unit.
- Do not delete or edit files on the SD card or USB HDD on the PC. If you do so, this unit may not be able to read these files or its functions may not operate correctly.
- When data not supported by this unit has been recorded on a PC, it will not be recognized by this unit.
- Always use this unit to format SD cards.

## Starting HD Writer LE 3.0

- To use the software, log on as an Administrator or as user name for standard user account.  
The software cannot be used with the user name for a guest account.

(On the PC)

Select [Start] → [All Programs] → [Panasonic] → [HD Writer LE 3.0] → [HD Writer LE 3.0].

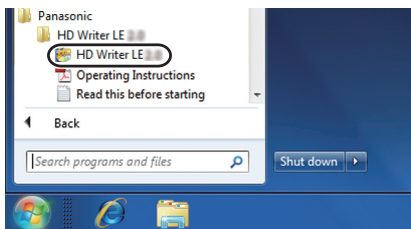

- For details on how to use the software applications, read the PDF operating instructions of the software.

## Reading the operating instructions of the software applications

- You will need Adobe Acrobat Reader 5.0 or later or Adobe Reader 7.0 or later to read the PDF operating instructions.

Select [Start] → [All Programs] → [Panasonic] → [HD Writer LE 3.0] → [Operating Instructions].

## If using Mac (mass storage)

- HD Writer LE 3.0 is not compatible with Mac.
- iMovie and Final Cut Pro X supported. For details about iMovie and Final Cut Pro X, please contact Apple Inc.

### ■ Operating environment

PC	Mac
OS	OS X v10.11
CPU	Intel Core 2 Duo or better
RAM	2 GB or more
Interface	USB port
Other requirements	Mouse or equivalent pointing device

- Even if the system requirements mentioned in this owner's manual are fulfilled, some computers cannot be used.
- The USB equipment operates with the driver installed as standard in the OS.

### ■ Copying still pictures on a Mac

#### 1 Connect this unit to a Mac via the supplied USB cable.

- The USB function selection screen will appear.

#### 2 Touch [PC] on the screen of this unit.

- This unit is automatically recognized as an external drive of Mac.
- When you select an option other than [PC], reconnect the USB cable.
- When using the battery, the LCD monitor turns off after about 5 seconds. Touch the screen to turn the LCD monitor on.

#### 3 Double-click [CAM\_SD] displayed on the desktop.

- Files are stored in [100CDPFQ] folder etc. in the [DCIM] folder.

#### 4 Using a drag-and-drop operation, move the pictures you want to acquire or the folder storing those pictures to any different folder on the Mac.

### ■ To disconnect USB cable safely

Drag [CAM\_SD] disk icon to the [Trash], and then disconnect the USB cable.

# Indications

## ■ Recording indications

Motion Picture Recording Mode

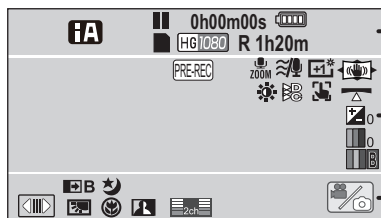

Still Picture Recording Mode

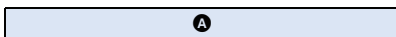
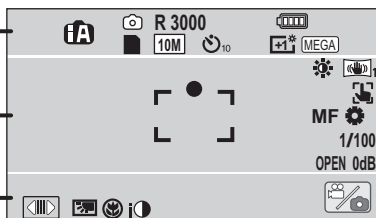

Intelligent Auto Mode (→ 40)



Intelligent Auto Plus Mode (→ 42)



Creative Control Mode (→ 42)



Scene Mode (→ 45)

**MNL** Manual Mode (→ 47)

Endless Loop Recording Mode (→ 46)

**●/II (Red)** Recording

**II (Green)** Recording pause

**0h00m00s** Elapsed recording time (→ 20)

("h" is an abbreviation for hour, "m" for minute and "s" for second.)

Eye-Fi transfer (→ 106)

Remaining battery power (→ 11)

**■ (White)** Card recording possible status

**■ (Green)** Recognizing the card

**1080/60p / PH1080 / HA1080 / HG1080 / HE1080 /**

**1080 / 720 / iFrame**

Motion Picture Recording Mode (→ 62)

**R 1h20m** Remaining time for motion picture recording (→ 20)

**(White)** Still picture recording icon

**(Red)** Recording still picture

**R3000** Remaining number of still pictures (→ 22)

















**10M / 2.1M / 7.4M / 0.3M / 7.7M / 2M**









Number of recording pixels for still pictures (→ 22, 67, 69)

In Playback Mode, the picture size is not displayed for still pictures recorded with other products that have different picture sizes from the sizes shown above.

**10/2** Self-timer Recording (→ 58)

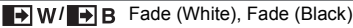
**MEGA** MEGA OIS (→ 22)

<b>B</b>	
	PRE-REC (→ 58)
	Time Lapse Recording (→ 44)
	Zoom Microphone (→ 65)
	Stereo Microphone (→ 65)
	Wind cut (→ 65)
	Power LCD (→ 32)
	Image Stabilizer (→ 52)/Optical Image Stabilizer Lock (→ 54)
	Picture Adjustment (→ 66)
	Digital Cinema Color (→ 64)
	Brightness Adjustment (Miniature Effect/8mm movie/Silent movie) (→ 43, 44)
	Vividness Adjustment (Miniature Effect) (→ 43)
	Color balance Adjustment (8mm movie) (→ 44)
	AF/AE tracking (→ 53)
	Level Shot Function (→ 38)
	Touch Shutter (→ 55)
<b>MF</b>	Manual Focus (→ 50)
	White Balance (→ 48)
<b>1/100</b>	Shutter Speed (→ 49)
<b>OPEN/F2.0</b>	Iris value (→ 49)
<b>0dB</b>	Gain value (→ 49)
<b>○ (White)/● (Green)</b>	Focus indication (→ 21)

<b>C</b>	
	Display Touch Menu (→ 17)
	Backlight Compensation (→ 59)
	Tele Macro (→ 59)
	Intelligent Contrast Control (→ 57)
	Microphone Level (→ 66)
	Fade (White), Fade (Black) (→ 57)
	Night Mode (→ 59)
	Intelligent Exposure (→ 58)
	World Time setting (→ 28)
	Recording mode switching icon (→ 15)
<b>NOV 15 2016</b>	Date indication (→ 18)
<b>12:34PM</b>	Time indication (→ 18)



## ■ Playback indications



Display during playback (→ 25, 68)

<b>0h00m00s</b>	Playback Time (→ 25)
<b>No.10</b>	Scene Number
	Repeat Playback (→ 70)
	Resume Playback (→ 71)
<b>100-0001</b>	Still picture folder/file name
	Transfer/Protected motion pictures/still pictures (→ 88, 105)

AVCHD / 1080/60p / 1080/60i / MP4/iFrame / 1080 /  
720 / 360 / iFrame

Play mode selection display (→ 24)

	AVCHD [1080/60p] scene (→ 24)
	AVCHD [PH] scene (→ 24)
	AVCHD [HA] scene (→ 24)
	AVCHD [HG] scene (→ 24)
	AVCHD [HE] scene (→ 24)
	MP4 [1080/60p] scene (→ 24)
	MP4 [720/30p] scene (→ 24)
	MP4 [360/30p] scene (→ 24)
	iFrame scene (→ 24)
<b>MINI</b>	Miniature-recorded scene (→ 43)
	Time lapse-recorded scene (→ 44)
	Scenes saved with Highlight Playback (→ 78)
	Eye-Fi transfer status (→ 104)

## ■ Indication of connection to USB HDD

USB HDD Playback (→ 99)

## ■ Indication of connection to other devices

Accessing the card (→ 101, 115)

## ■ Confirmatory indications

(Time display) The built-in battery is low. (→ 18)

Warning for recording of yourself (→ 19)

SD card is not inserted or is incompatible.

# Messages

Major confirmation/error messages to be indicated on the screen in text.

## CHECK CARD.

This card is not compatible or it cannot be recognized by the unit.

If this message appears even though motion pictures and still pictures are recorded on an SD card, the card may be unstable. Reinsert the SD card, then turn the unit off and then on again.

## THIS BATTERY CANNOT BE USED.

- Use a battery that is compatible with this unit. (→ 9)  
If using a Panasonic battery compatible with this unit, remove the battery and then insert it again. If the message appears even after repeating this several times, this unit needs repair. Detach the power and consult the dealer who you purchased this unit from. Do not attempt to repair it by yourself.
- You are attempting to connect an AC adaptor not compatible with this unit. Use the supplied AC adaptor. (→ 10)

## THIS EXTERNAL DRIVE CANNOT BE USED./ PLEASE CHECK THE EXTERNAL DRIVE.

The external drive that this unit cannot recognize is connected. Check if the USB HDD can be connected and used with this unit and try to reconnect. (→ 95)

## About recovery

If faulty management information is found, the messages may appear and a repair is performed. (Repairing may take time depending on the error.)

-  is displayed when abnormal management information is detected when the scenes are displayed in thumbnail.
- 
- Use a sufficiently charged battery or the AC adaptor.
  - Depending on the condition of the data, it may not be possible to completely repair the data.
  - If recovery fails, it will not be possible to play back scenes recorded before the unit turned off.
  - When data recorded on another device is recovered, it may not be possible to play back the data on this unit or the other device.
  - If recovery fails, turn the unit off and on again after waiting a while. If recovery fails repeatedly, format a media on the unit. Please be aware that if a media is formatted, then all the data recorded on the media will be erased.
  - If the thumbnail information is recovered, displaying the thumbnails may become slower.

# Troubleshooting



## ■ It is not a malfunction in following cases

<b>A clicking sound is heard when the unit is shaken.</b>	<ul style="list-style-type: none"> <li>This is the sound of the lens moving and is not a defect. This sound will no longer be heard when the unit is turned on and set this unit to the Motion Picture Recording Mode or Still Picture Recording Mode.</li> </ul>
<b>Object seems to be warped.</b>	<ul style="list-style-type: none"> <li>Object seems to be warped slightly when the object moves across the image very fast, but this is because the unit is using MOS for the image sensor. This is not a malfunction.</li> </ul>
<b>The lens or LCD monitor fog up.</b>	<ul style="list-style-type: none"> <li>This is due to condensation. It is not a malfunction. Please refer to page 2.</li> </ul>



## Power

Problem	Check points
<p><b>This unit cannot be turned on.</b></p> <p><b>This unit does not stay on long enough.</b></p> <p><b>Battery runs down quickly.</b></p>	<ul style="list-style-type: none"> <li>Charge the battery again to ensure it is sufficiently charged. (→ 10)</li> <li>In cold places, the battery using time becomes shorter.</li> <li>The battery has a limited life. If the operating time is still too short even after the battery is fully charged, the battery has worn out and needs to be replaced.</li> </ul>
<b>This unit is turned off automatically.</b>	<ul style="list-style-type: none"> <li>If the unit turns off when you turn off the power to the TV using the TV remote control, the VIERA Link is at work. If you are not using the VIERA Link, set [VIERA Link] to [OFF]. (→ 93)</li> </ul>
<p><b>This unit cannot be operated though it is turned on.</b></p> <p><b>This unit does not operate normally.</b></p>	<ul style="list-style-type: none"> <li>Remove the battery or AC adaptor, wait about 1 minute and then reconnect the battery or AC adaptor. Then about 1 minute later, turn on the unit again. (Conducting the above operation while the media is being accessed may damage the data on the media.)</li> <li>If normal operation is still not restored, detach the power connected, and consult the dealer who you purchased this unit from.</li> </ul>
<b>"ERROR OCCURRED. PLEASE TURN UNIT OFF, THEN TURN ON AGAIN." is displayed.</b>	<ul style="list-style-type: none"> <li>The unit has automatically detected an error. Restart the unit by turning the unit off and on.</li> <li>The unit will be turned off in about 1 minute if the unit is not turned off and on.</li> <li>Repair is needed if it is repeatedly displayed even if it is restarted. Detach the power connected, and consult the dealer who you purchased this unit from. Do not attempt to repair the unit by yourself.</li> </ul>

## Recording

Problem	Check points
<p><b>The unit arbitrarily stops recording.</b></p>	<ul style="list-style-type: none"> <li>● Use an SD card that can be used for motion picture recording. (→ 12)</li> <li>● The recordable time may have shortened due to the deterioration of the data writing speed or repeated recording and deletion. Using the unit, format the SD card. (→ 34)</li> <li>● If [AGS] is [ON], record in the normal horizontal position or set [AGS] to [OFF]. (→ 64)</li> </ul>
<p><b>Auto Focus function does not work.</b></p>	<ul style="list-style-type: none"> <li>● Switch to Intelligent Auto Mode or Intelligent Auto Plus Mode.</li> <li>● If you are trying to record a scene which is hard to bring into focus in Auto Focus Mode, use the Manual Focus Mode to adjust the focus. (→ 41, 50)</li> </ul>
<p><b>Color balance of images is strange when recording in a place such as a gymnasium.</b></p>	<ul style="list-style-type: none"> <li>● In a place with multiple light sources, such as a gymnasium or a hall, set the White Balance setting to  (Indoor mode 2). If you cannot record clearly with the  (Indoor mode 2), set it to  (Manual adjustment mode). (→ 48)</li> </ul>
<p><b>Color or brightness of the image changes, or you may see horizontal bars in the image.</b></p> <p><b>The LCD monitor flickers indoors.</b></p>	<ul style="list-style-type: none"> <li>● Color or brightness of the image may change, or you may see horizontal bars in the image when the object is recorded under fluorescent light, mercury light or sodium light, etc., but this is not a malfunction.</li> <li>● In Motion Picture Recording Mode, record in Intelligent Auto Mode/Intelligent Auto Plus Mode or set the shutter speed to 1/60 in areas where the power supply frequency is 60 Hz, or 1/100 in areas of 50 Hz.</li> <li>● In Still Picture Recording Mode, this will not affect the recorded image.</li> </ul>
<p><b>“ENVIRONMENT TOO DARK, OR LENS COVER CLOSED.” is displayed.</b></p>	<ul style="list-style-type: none"> <li>● Before turning on the unit, open the lens cover.</li> <li>● This message may also be displayed when recording in a very dark location.</li> </ul>

## Playback

Problem	Check points
<b>Scenes/still pictures cannot be played back.</b>	<ul style="list-style-type: none"> <li>Any scenes/still pictures where the thumbnails are displayed as  cannot be played back.</li> </ul>
<b>Scenes cannot be deleted.</b>	<ul style="list-style-type: none"> <li>Release the protect setting. (→ 88)</li> <li>Any scenes/still pictures where the thumbnails are displayed as  cannot be deleted. If the scenes/still pictures are unnecessary, format the media to erase the data. (→ 34) Please be aware that if a media is formatted then all the data recorded on the media is erased and cannot be recovered. Back up important data on a PC, disc etc.</li> </ul>

## With other products

Problem	Check points
<p><b>Even when this unit is correctly connected to a TV, images or sounds are not output.</b></p> <p><b>The images are squeezed horizontally.</b></p>	<ul style="list-style-type: none"> <li>Please read the operating instructions of your TV and select the channel that matches the input used for the connection.</li> <li>Change the [TV ASPECT] setting to match the aspect ratio of the TV. (→ 92)</li> <li>The audio during playback mode is not output from this unit when connected to a TV. Sound levels cannot be adjusted using this unit, so adjust the sound on the TV.</li> </ul>
<b>Even when this unit is connected to the TV by the HDMI mini cable, images or sounds are not output.</b>	<ul style="list-style-type: none"> <li>Check if the HDMI mini cable is connected correctly.</li> <li>Insert the HDMI mini cable all the way in.</li> </ul>
<b>If the SD card is inserted in another device, it is not recognized.</b>	<ul style="list-style-type: none"> <li>Check that the device is compatible with the capacity or type of SD card (SD Memory Card/SDHC Memory Card/SDXC Memory Card) that you inserted. Refer to the operating instructions of the device for details.</li> </ul>
<b>When connected by the USB cable, this unit is not detected by the other devices.</b>	<ul style="list-style-type: none"> <li>When connected to other devices using only the battery, reconnect using the AC adaptor.</li> </ul>
<b>VIERA Link does not work.</b>	<p>(Setting on this unit)</p> <ul style="list-style-type: none"> <li>Connect with an HDMI mini cable (supplied). (→ 90)</li> <li>Touch , then touch [SETUP] → [VIERA Link] → [ON]. (→ 93)</li> <li>Turn the unit off and then back on again.</li> </ul> <p>(Setting on other devices)</p> <ul style="list-style-type: none"> <li>If the TV input does not switch automatically, switch the input using the TV remote control.</li> <li>Check the VIERA Link setting on the connected device.</li> <li>Please refer to the operating instructions of the connected device.</li> </ul>

### With other products

Problem	Check points
Cannot copy scenes on the SD card by connecting to other equipment with the USB cable.	<ul style="list-style-type: none"> <li>Other equipment might have not recognized the SD card. Unplug the USB cable once, and reconnect it.</li> </ul>

### With a PC

Problem	Check points
When connected by the USB cable, this unit is not detected by the PC.	<ul style="list-style-type: none"> <li>After re-inserting the SD card into the unit, reconnect the supplied USB cable.</li> <li>Select another USB terminal on the PC.</li> <li>Check the operating environment. (→ 111, 118)</li> <li>Connect the supplied USB cable again after restarting the PC and turning on this unit again.</li> </ul>
When the USB cable is disconnected, an error message will appear on the PC.	<ul style="list-style-type: none"> <li>To disconnect the USB cable safely, select the  icon in task tray displayed on the PC, and then select the model number of this unit to disconnect the USB cable.</li> </ul>
Cannot see the PDF operating instructions for HD Writer LE 3.0.	<ul style="list-style-type: none"> <li>You will need Adobe Acrobat Reader 5.0 or later or Adobe Reader 7.0 or later to read the PDF operating instructions for HD Writer LE 3.0.</li> </ul>

### Others

Problem	Check points
If the SD card is inserted in this unit, it is not recognized.	<ul style="list-style-type: none"> <li>If the SD card is formatted on a PC, it may not be recognized by this unit. Use this unit to format SD cards. (→ 34)</li> </ul>

## ■ If AVCHD scenes do not change smoothly when played back on another device

The images may be still for several seconds at the joins between the scenes if the following operations are performed when multiple scenes have been continuously played back using another unit.

- Just how smoothly the scenes will be played back depends on the playback unit. Depending on the unit used, the images may stop moving and become still for a moment even when none of the following conditions are applicable.
- A continuous recording of motion picture data that exceeds 4 GB may momentarily stop at every 4 GB of data when played back with another device.
- It may not play back smoothly when the editing of scenes was done with the HD Writer LE 3.0, but it will play back smoothly if you set the seamless settings in the HD Writer LE 3.0. Refer to the operating instructions for the HD Writer LE 3.0.

<b>Principal reasons for not playing back smoothly</b>
● <b>When the scenes were recorded on different dates</b>
● <b>When scenes lasting under 3 seconds have been recorded</b>
● <b>When PRE-REC was used for recording</b>
● <b>When the Miniature Effect recording is used</b>
● <b>When the Time Lapse Recording is used</b>
● <b>When deleting scenes</b>
● <b>When scenes recorded more than 99 scenes on the same date</b>

# Cautions for use

## About this unit

The unit and the SD card become warm during use. This is not a malfunction.

**Keep this unit as far away as possible from electromagnetic equipment (such as microwave ovens, TVs, video games etc.).**

- If you use this unit on top of or near a TV, the pictures and/or sound on this unit may be disrupted by electromagnetic wave radiation.
- Do not use this unit near cell phones because doing so may result in noise adversely affecting the pictures and/or sound.
- Recorded data may be damaged, or pictures may be distorted, by strong magnetic fields created by speakers or large motors.
- Electromagnetic wave radiation generated by microprocessors may adversely affect this unit, disturbing the pictures and/or sound.
- If this unit is adversely affected by electromagnetic equipment and stops functioning properly, turn this unit off and remove the battery or disconnect AC adaptor. Then reinsert the battery or reconnect AC adaptor and turn this unit on.

**Do not use this unit near radio transmitters or high-voltage lines.**

- If you record near radio transmitters or high-voltage lines, the recorded pictures and/or sound may be adversely affected.

**Make sure to use the supplied cords and cables. If you use optional accessories, use the cords and the cables supplied with them.**

**Do not extend the cords and the cables.**

**Do not spray insecticides or volatile chemicals onto the unit.**

- If the unit is sprayed with such chemicals, its body may be marred and the surface finish may peel off.
- Do not leave rubber or plastic products in contact with the unit for a long time.

**When you use the unit in a sandy or dusty place such as a beach, do not let sand or fine dust get into the body and terminals of the unit.**

**Also, keep the unit away from sea water.**

- Sand or dust may damage the unit. (Care should be taken when inserting and removing a card.)
- If sea water splashes onto the unit, wipe off the water with a well wrung cloth. Then wipe the unit again with a dry cloth.

**When carrying the unit, do not drop or bump it.**

- A strong impact can break the unit's casing, causing it to malfunction.

## Cleaning

- Before cleaning, detach the battery or pull the AC adaptor from the AC outlet, and then wipe the unit with a soft, dry cloth.
- If the unit is very dirty, dip a cloth in water and squeeze firmly, and then wipe the unit with the damp cloth. Next, dry the unit with a dry cloth.
- Use of benzine, paint thinner, alcohol, or dishwashing liquid may alter the camera body or peel the surface finish. Do not use these solvents.
- When using a chemical dust cloth, follow the instructions that came with the cloth.



### **Do not use the unit for surveillance purposes or other business uses.**

- This unit was designed for consumer intermittent use. It was not intended for continuous use, or for any industrial or commercial application resulting in prolonged use.
- In certain situations, continuous use could cause the unit to overheat and cause a malfunction. Such use is strongly discouraged.

### **When you are not going to use the unit for an extended time**

- When storing the unit in a cupboard or cabinet, it is recommended that you place a desiccant (silica gel) in with it.

## **About the battery**

The battery used in this unit is a rechargeable lithium-ion battery. It is susceptible to humidity and temperature and the effect increases the more the temperature rises or falls. In cold areas, the full charge indication may not appear or the low battery indication may appear about 5 minutes after starting use. At high temperatures, the protection function may be triggered, making it impossible to use the unit.

### **Be sure to detach the battery after use.**

- If the battery is left attached, a minute amount of current continues to flow even if the unit is off. Keeping the unit in this state may result in over discharge of the battery. This may result in you not being able to use the battery even after it is charged.
- The battery should be stored in the vinyl bag so metal does not come into contact with the terminals.
- The battery should be stored in a cool place free from humidity, with as constant temperature as possible. (Recommended temperature: 15 °C to 25 °C (59 °F to 77 °F), Recommended humidity: 40%RH to 60%RH)
- Extremely high temperatures or low temperatures will shorten the life of the battery.
- If the battery is kept in high-temperature, high-humidity, or oily-smoky places, the terminals may rust and cause malfunctions.

- To store the battery for a long period of time, we recommend you charge it once every year and store it again after you have completely used up the charged capacity.
- Dust and other matter attached to the battery terminals should be removed.

### **Prepare spare batteries when going out for recording.**

- Prepare batteries enough to last for 3 to 4 times the period you are planning to record for. Cold places such as a ski resort can shorten recording time.

### **If you drop the battery accidentally, check to see if the terminals are damaged.**

- Inserting a battery with damaged terminals can damage the unit.

### **Do not throw an old battery into fire.**

- Heating a battery or throwing it into a fire may result in an explosion.

### **If the operating time is very short even after the battery has been recharged, the battery has worn out. Please purchase a new battery.**

## **About the AC adaptor**

- If the temperature of the battery is extremely high or extremely low, charging may take time or the battery may not be charged.
- If you use the AC adaptor near a radio, radio reception may be disturbed. Keep the AC adaptor 1 m (3.3 feet) or more away from the radio.
- When using the AC adaptor, it may generate whirring sounds. However, this is normal.
- After use, be sure to disconnect the AC adaptor. (If it is left connected, a minute amount of current is consumed.)
- Always keep the electrodes of the AC adaptor and battery clean.

## About status indicator during charging

When the status indicator is flashing at a particularly fast or slow rate, the following should be considered.

**Flashing with approx. 4 second period (off for approx. 2 seconds, on for approx. 2 seconds):**

- When the battery is over discharged or the temperature of the battery is too high or low. It can be charged, but it may take a few hours to complete the charging normally.
- It will flash in approx. 2 second intervals when normal charging resumes. Even in such cases, it may start flashing in approx. 4 second intervals until charging is completed depending on the conditions of use.

**Flashing with approx. 0.5 second period (off for approx. 0.25 second, on for approx. 0.25 second):**

- The battery is not charged. Remove the battery from the unit, and try charging again.
- Check that the terminals of the unit or battery are not dirty or covered with a foreign object, and connect the battery correctly once again. If a foreign object or dirt is present, turn off the unit before removing.
- The battery or environment is at an extremely high or low temperature. Wait until the temperature has returned to an appropriate level and try charging again. If you are still unable to charge, there may be a fault in the unit, battery or AC adaptor.

**Off:**

- Charging has finished.
- If the status indicator stays off despite the charging being unfinished, there may be a fault in the unit, battery or AC adaptor. Refer to page 129 for details on the battery.

## About the SD card

When disposing of or giving away the SD card, note that:

- Formatting and deletion of data on this unit or computer only changes the file management information and does not completely delete the data in the SD card.
- It is recommended that the SD card is physically destroyed or the SD card is physically formatted using this unit when disposing of or giving away the SD card.

To physically format the SD card, connect the unit via the AC adaptor, select [SETUP] → [FORMAT MEDIA] → [YES] from the menu, and then press and hold the recording start/stop button on the screen below for about 3 seconds. When the SD card data deletion screen appears, select [YES], and then follow the on-screen instructions.

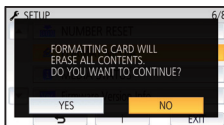

- The customer is responsible for the management of the data in the SD card.

## LCD monitor

- When the LCD screen is dirty or condensation has occurred, please wipe it using a soft cloth such as eyeglass cleaner.
- Do not touch the LCD monitor with your fingernails, or rub or press with strong force.
- It may become hard to see or hard to recognize the touch when the LCD protection sheet is affixed.
- When the unit has become very cold, for example due to storage in a cold area, its LCD monitor will be slightly darker than usual immediately after the unit is turned on. The normal brightness will be restored when the unit's internal temperature rises.

Extremely high precision technology is employed to produce the LCD Monitor screen. The result is more than 99.99% effective dots with a mere 0.01% of the dots inactive or always lit. However, this is not a malfunction and does not affect the recorded picture.

## About personal information

When a name or birthday is set by Baby Calendar, personal information will be included in this unit.

### Disclaimer

- Information including personal information may be altered or vanish due to erroneous operation, effect of static electricity, accident, malfunction, repair, or other handlings. Please note in advance that Panasonic is not liable in any way for any direct or indirect damage from the alteration or vanishing of information or personal information.

### When requesting a repair, transferring to another party, or disposing.

- To protect personal information, delete the registered details of Baby Calendar unless they are necessary for the repair. (→ 83)
- Remove the Memory Card from this unit when requesting a repair.
- Settings may return to factory default when this unit is repaired.
- Please contact the dealer where you purchased this unit or Panasonic if above operations are not possible due to malfunction.

**When transferring to another party, or disposing of the Memory Card, please refer to “When disposing of or giving away the SD card, note that:”. (→ 130)**

### When uploading images on web services

- Images may contain information that can be used for identifying individuals such as titles and recording dates. When uploading images on web services, check carefully, and then upload.

# About copyright

## ■ Carefully observe copyright laws

**Whatever you have recorded and created can be used for your personal entertainment only. Under copyright laws, other materials cannot be used without obtaining permission from the holders of the copyrights.**

## ■ Licenses

- SDXC Logo is a trademark of SD-3C, LLC.
- "AVCHD", "AVCHD Progressive" and the "AVCHD Progressive" logo are trademarks of Panasonic Corporation and Sony Corporation.
- Manufactured under license from Dolby Laboratories. Dolby and the double-D symbol are trademarks of Dolby Laboratories.
- The terms HDMI and HDMI High-Definition Multimedia Interface, and the HDMI Logo are trademarks or registered trademarks of HDMI Licensing, LLC in the United States and other countries.
- VIERA Link™ is a trademark of Panasonic Corporation.
- EZ Sync™ is a trademark of Panasonic Corporation.
- HDAVI Control™ is a trademark of Panasonic Corporation.
- x.v.Color™ is a trademark.
- Microsoft®, Windows® and Windows Vista® are either registered trademarks or trademarks of Microsoft Corporation in the United States and/or other countries.
- Microsoft product screen shot(s) reprinted with permission from Microsoft Corporation.
- Intel®, Pentium® and Intel®Core™ are trademarks of Intel Corporation in the U.S. and/or other countries.
- AMD Athlon™ is a trademark of Advanced Micro Devices, Inc.
- iMovie, Final Cut Pro, Mac and OS X are trademarks of Apple Inc. registered in the U.S. and other countries.
- QR Code is a registered trademark of DENSO WAVE INCORPORATED.
- "Eye-Fi" is a trademark of Eye-Fi, Inc.
- Other names of systems and products mentioned in these instructions are usually the registered trademarks or trademarks of the manufacturers who developed the system or product concerned.

This product is licensed under the AVC Patent Portfolio License for the personal use of a consumer or other uses in which it does not receive remuneration to (i) encode video in compliance with the AVC Standard ("AVC Video") and/or (ii) decode AVC Video that was encoded by a consumer engaged in a personal activity and/or was obtained from a video provider licensed to provide AVC Video. No license is granted or shall be implied for any other use. Additional information may be obtained from MPEG LA, L.L.C. See <http://www.mpegla.com>

# Recording modes/approximate recordable time

- The stated times are the approximate recordable times for continuous recording.



Recording format		[AVCHD]				
Recording mode		[1080/60p]	[1080/60i]			
Picture size/ Frame rate			[PH]	[HA]	[HG]	[HE]
		1920×1080/ 60p	1920×1080/ 60i	1920×1080/ 60i	1920×1080/ 60i	1920×1080/ 60i
SD card	4 GB	19 min	21 min	30 min	40 min	1 h 30 min
	16 GB	1 h 20 min	1 h 30 min	2 h	2 h 40 min	6 h 40 min
	64 GB	5 h 20 min	6 h	8 h 30 min	11 h	27 h 30 min

- A** Favors image quality
- B** Favors Recording time

Recording format		[MP4/iFrame]		
Recording mode		[1080]	[720]	[iFrame]
Picture size/ Frame rate		1920×1080/ 60p	1280×720/ 30p	960×540/ 30p
SD card	4 GB	19 min	1 h	19 min
	16 GB	1 h 20 min	4 h 10 min	1 h 20 min
	64 GB	5 h 20 min	16 h 50 min	5 h 20 min

- "h" is an abbreviation for hour, "min" for minute and "s" for second.
- If recording for long periods, prepare batteries for 3 or 4 times the period you wish to record for. (→ 11)
- The default setting for [REC FORMAT] is [AVCHD], and the default setting for [REC MODE] is [HG].
- Maximum continuously recordable time for one scene: 6 hours
- The recording is paused once the recording time for one scene exceeds 6 hours, and the recording will automatically resume after a few seconds.
- The recordable time may be reduced when lot of action scenes are recorded or recording of short scene is repeated.
- Use time in the row of 4 GB in above table as a guideline for the time that can be copied onto one DVD disc (4.7 GB).
- The maximum remaining recordable time that can be displayed for motion picture recording is 99 hours and 59 minutes. Any remaining recordable time exceeding 99 hours and 59 minutes will be displayed as "R99h59m+". This display remains unchanged until the remaining recordable time drops to 99 hours and 59 minutes or less.

# Approximate number of recordable pictures

- The stated number is the approximate number of recordable pictures.

Picture size		10M 4224×2376	2.1M 1920×1080	7.4M 3136×2352	0.3M 640×480
Aspect ratio		[16:9]		[4:3]	
SD card	4 GB	600	3200	800	14000
	16 GB	2500	12500	3300	58000
	64 GB	10000	52000	13000	237000

Picture size		7.7M 3408×2272	2M 1728×1152
Aspect ratio		[3:2]	
SD card	4 GB	800	2200
	16 GB	3200	8500
	64 GB	13000	36000

- The number of recordable pictures depends on the subject being recorded.**
- Maximum number of recordable pictures that can be displayed is 9999. If the number of recordable pictures exceeds 9999, R 9999+ is displayed. The number will not change when the picture is taken until the number of recordable pictures is 9999 or less.
- The memory capacity indicated on the label of an SD card is the total of the capacity for copyright protection and management and the capacity which can be used on the unit, a PC etc.

# Optional accessories

Some optional accessories may not be available in some countries.

## About the Remote Pan Tilt Cradle

If you connect this unit to the Remote Pan Tilt Cradle VW-CTR1 (optional) by USB cable, this unit can automatically track the movement of the subject being recorded. This unit zooms in/out the image automatically, and the Remote Pan Tilt Cradle pans and tilts this unit.

### Connecting the Remote Pan Tilt Cradle to this unit

#### 1 Attach this unit to the Remote Pan Tilt Cradle.

- For details on attachment method, refer to the operating instructions of Remote Pan Tilt Cradle.

#### 2 Connect the Remote Pan Tilt Cradle to this unit using the USB cable (supplied with this unit).

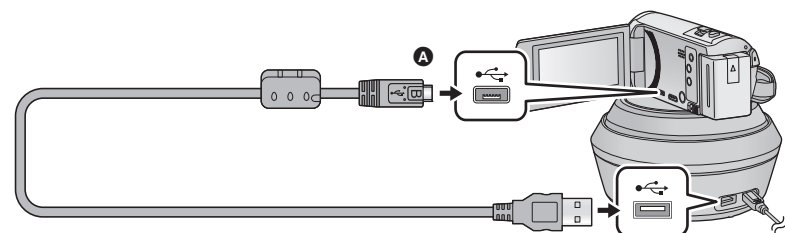

- A** Turn the side with the symbol up to connect the micro B end of the USB Cable to the USB terminal of this unit.

#### 3 Press the power button of the Remote Pan Tilt Cradle to turn it on.

- The status indicator **B** lights on.

#### 4 Turn on this unit.

#### 5 Touch [Remote Pan Tilt Cradle].

- The Remote Pan Tilt Cradle Mode selection screen is displayed.
- If you have touched an item other than [Remote Pan Tilt Cradle] or if the Remote Pan Tilt Cradle is not recognized correctly, reconnect the USB cable.
- If you turn off and on this unit with the USB cable connected, this unit may operate in the previous Remote Pan Tilt Cradle Mode.

#### 6 Install the Remote Pan Tilt Cradle so that its home position will face the front of the subject.

- The home position runs through the center of the power button.

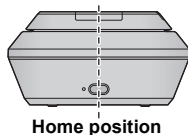
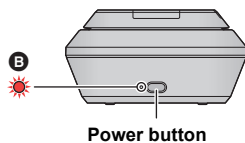

- Do not use any other USB cables except the supplied one. (Operation is not guaranteed with any other USB cables.)
- As shown in the illustration, connect the USB cable or DC cable so that it will not be caught in objects such as the moving part of the Remote Pan Tilt Cradle and other cables. If the cable is caught in the moving part of the Remote Pan Tilt Cradle, it may cause the recording position to change or cause a malfunction.
- Install the Remote Pan Tilt Cradle in a location that meets the following requirements:
  - A location out of the reach of children and pets
  - A level location with no obstacles
  - A location approximately 2 to 3 m away from subjects
- Before mounting this unit on the Remote Pan Tilt Cradle, insert the SD card and the battery.
- When this unit is mounted on the Remote Pan Tilt Cradle, make sure to hold the Remote Pan Tilt Cradle to carry them. Carrying them by holding this unit may cause malfunction.
- Do not use the Remote Pan Tilt Cradle for surveillance purposes.
- Do not force the Remote Pan Tilt Cradle to stop moving during panning/tilting operation.
- The Remote Pan Tilt Cradle is not capable of supplying power to this unit.
- When the Remote Pan Tilt Cradle detects a problem, its status indicator flashes, and both this unit and the Remote Pan Tilt Cradle turn off.

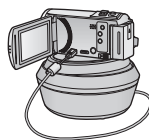

## Using the Remote Pan Tilt Cradle

- **Connecting the Remote Pan Tilt Cradle to this unit. (→ 135)**
- **Set [Panning Angle]/[Tilt Angle]/[Tilt Speed] in advance. (→ 138)**

### 1 Touch the desired Remote Pan Tilt Cradle Mode.

Mode	Operation of the Remote Pan Tilt Cradle	Description
[Party Scene]	The operation is automatic. <ul style="list-style-type: none"> <li>• The Remote Pan Tilt Cradle works within the recording range set in [Panning Angle]/[Tilt Angle].</li> </ul>	At an event such as a party, recording will be performed while the Remote Pan Tilt Cradle automatically controls the recording direction within the recording range. <ul style="list-style-type: none"> <li>• When a person or a moving object is detected, recording of the person or the object takes priority for a specific period of time.</li> </ul>
[Moving Object]		When a moving object is detected within the recording range, the object will be tracked and recorded automatically.
[Manual]	The operation is manual.	This mode lets you manually operate the Remote Pan Tilt Cradle.

- If you touch [SETUP], the Setup menu will be displayed. (→ 138)

### 2 (When [Manual] is selected)

**Touch , and operate the Remote Pan Tilt Cradle with / / / .**

- When you finish the operation, touch [ENTER].



### 3 Press the recording start/stop button.

(When [Party Scene]/[Moving Object] is selected)

- Before recording starts, the Remote Pan Tilt Cradle rotates and returns to its home position. It takes time until recording starts.
- The Remote Pan Tilt Cradle operates within the range set in advance.

(When [Manual] is selected)

- Performing the operation of Step 2 during recording may cause the recording screen to shake or the Remote Pan Tilt Cradle to move from its original location.

#### **To switch the Remote Pan Tilt Cradle Mode**

Touch .

- The selection screen of the Remote Pan Tilt Cradle Mode is displayed. Touch the desired mode.

#### **To exit the Remote Pan Tilt Cradle**

Touch [EXIT].

- The Remote Pan Tilt Cradle rotates and returns to its home position.
- After the operation, the Remote Pan Tilt Cradle turns off. Before removing this unit, disconnect the USB cable.

- 
- When this unit is connected to the Remote Pan Tilt Cradle, this unit is set to Motion Picture Recording Mode. You cannot switch this unit to Still Picture Recording Mode.
  - We recommend that you make a test recording in advance to check if the image and sound are recorded correctly.
  - The sound of the Remote Pan Tilt Cradle in operation will be recorded.
  - If you start recording after making changes to the setup of the Remote Pan Tilt Cradle, such as switching the Remote Pan Tilt Cradle Mode or changing the location of the Remote Pan Tilt Cradle, it may rotate and return to its home position.
  - Once the operation starts, do not disconnect the USB cable or move the Remote Pan Tilt Cradle and this unit until the operation is finished. This may cause a malfunction or the motion picture not to be recorded correctly.
  - When you press the power button or when [ECONOMY (BATT)] (→ 31) or [ECONOMY (AC)] (→ 31) works, this unit and the Remote Pan Tilt Cradle will turn off after the Remote Pan Tilt Cradle rotates and returns to its home position.
  - When the Remote Pan Tilt Cradle is in operation, neither [ECONOMY (BATT)] nor [ECONOMY (AC)] will work.
  - The following functions will be set to [OFF]:
    - Level Shot Function
    - Optical Image Stabilizer
    - [SHOOTING GUIDE]
  - If you experience fatigue, a feeling of discomfort or other symptoms when playing back a scene recorded with the Remote Pan Tilt Cradle, stop the playback.

(About [Party Scene]/[Moving Object])

- Still pictures cannot be recorded during Motion picture recording.
- Depending on recording conditions, the color tone of the image being recorded may change or subjects may not be recorded automatically in cases such as the following:
  - The subject is too large or too small
  - The background and the subject are similar in color

- The recording location is dark
- Bright light is detected (sky, TV, lamp, etc.)
- The subject is moving too fast, or not moving
- The area being recorded is close to a window
- Depending on recording conditions, scenes may not be recorded as intended. In such cases, we recommend setting the mode to [Manual].

(About [Moving Object])

- When recording starts, a moving subject will be detected. Before recording, point the camera at the subject.
- This unit cannot track more than one subject simultaneously.
- Certain types of subjects, such as a fast moving subject, may not be tracked.

## Remote Pan Tilt Cradle settings

When the Remote Pan Tilt Cradle is connected to this unit, the Remote Pan Tilt Cradle setup menu can be set.

- **Connecting the Remote Pan Tilt Cradle to this unit (→ 135)**

**1** Touch [SETUP] in the Remote Pan Tilt Cradle Mode screen.

**2** Touch desired menu item.

### [Panning Angle] [±180°]/[±90°]/[±45°]/[Stationary]

Set the left/right pan range of the Remote Pan Tilt Cradle for [Party Scene]/[Moving Object].

<b>[±180°]:</b>	Pans to the left/right up to approx. 180 °.
<b>[±90°]:</b>	Pans to the left/right up to approx. 90 °.
<b>[±45°]:</b>	Pans to the left/right up to approx. 45 °.
<b>[Stationary]:</b>	Panning to the left/right is off.

### [Tilt Angle] [±15°]/[Stationary]

Set the up/down tilt range of the Remote Pan Tilt Cradle for [Party Scene]/[Moving Object].

<b>[±15°]:</b>	Tilts up/down up to approx. 15 °.
<b>[Stationary]:</b>	Tilting up/down is off.

### [Tilt Speed] [High]/[Normal]

Set the up/down operation speed of the Remote Pan Tilt Cradle.

## [Pan/Tilt Check]

---

You can confirm the operating range of the Remote Pan Tilt Cradle set for [Party Scene]/[Moving Object].

- The Remote Pan Tilt Cradle moves in the ranges set at [Panning Angle] and [Tilt Angle].
- When the confirmation operation is finished, the Remote Pan Tilt Cradle returns to its home position.

## [Firmware Version Info]

---

The firmware version of the Remote Pan Tilt Cradle is displayed.

## [Firmware Upgrade]

---

You can update the firmware version of the Remote Pan Tilt Cradle.

**For the latest update information, check the support website below. (As of November 2015)**

[http://panasonic.jp/support/global/cs/e\\_cam](http://panasonic.jp/support/global/cs/e_cam)  
(This Site is English only)

- Before updating this unit, update the Remote Pan Tilt Cradle.  
If you update this unit first, the Remote Pan Tilt Cradle may become unusable.

## [Party Scene Demo]

---

You can watch the demonstration of how the Remote Pan Tilt Cradle will operate when [Party Scene] is set.

- Touch [Party Scene Demo], the demonstration automatically starts.  
When you touch [EXIT], the demonstration will be canceled.

## [Moving Object Demo]

---

You can watch the demonstration of how the Remote Pan Tilt Cradle will operate when [Moving Object] is set.

- Touch [Moving Object Demo], the demonstration automatically starts.  
When you touch [EXIT], the demonstration will be canceled.

**Panasonic Corporation**  
Web site: <http://www.panasonic.com>