

Panasonic®

Owner's Manual

High Definition Video Camera

Model No. **HC-MDH3**

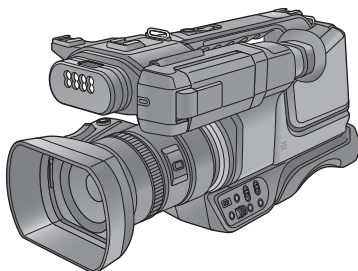

Please read these instructions carefully before using this product, and save this manual for future use.

AVCHD™
Progressive

HDMI

SD™
XC

DOLBY AUDIO™

Register online at <http://shop.panasonic.com/support> (U.S. customers only)

If you have any questions, visit :
U.S.A. : <http://shop.panasonic.com/support>
Canada : www.panasonic.ca/english/support

DVQP1612ZA

F0418AR0

PP

Dear Customer,

Thank you for choosing Panasonic!

You have purchased one of the most sophisticated and reliable products on the market today. Used properly, we're sure it will bring you and your family years of enjoyment. Please take time to fill in the information on the right.

The serial number is on the tag located on the back of your camera. Be sure to **retain this manual** as your convenient camera information source.

Date of Purchase _____

Dealer Purchased From _____

Dealer Address _____

Dealer Phone No. _____

Model No. _____

Serial No. _____

U.S.A./CANADA CONSUMERS: ATTENTION:



A lithium ion battery that is recyclable powers the product you have purchased. Please call 1-800-8-BATTERY for information on how to recycle this battery.

Safety Precautions

WARNING:

To reduce the risk of fire, electric shock or product damage,

- Do not expose this unit to rain, moisture, dripping or splashing.
- Do not place objects filled with liquids, such as vases, on this unit.
- Use the recommended accessories.
- Do not remove covers.
- Do not repair this unit by yourself. Refer servicing to qualified service personnel.

CAUTION!

To reduce the risk of fire, electric shock or product damage,

- Do not install or place this unit in a bookcase, built-in cabinet or in another confined space. Ensure this unit is well ventilated.
- Do not obstruct this unit's ventilation openings with newspapers, tablecloths, curtains, and similar items.
- Do not place sources of naked flames, such as lighted candles, on this unit.

THE FOLLOWING APPLIES ONLY IN THE U.S.A.

FCC Note:

This equipment has been tested and found to comply with the limits for a Class B digital device, pursuant to Part 15 of the FCC Rules. These limits are designed to provide reasonable protection against harmful interference in a residential installation. This equipment generates, uses, and can radiate radio frequency energy and, if not installed and used in accordance with the instructions, may cause harmful interference to radio communications. However, there is no guarantee that interference will not occur in a particular installation. If this equipment does cause harmful interference to radio or television reception, which can be determined by turning the equipment off and on, the user is encouraged to try to correct the interference by one or more of the following measures:

- Reorient or relocate the receiving antenna.
- Increase the separation between the equipment and receiver.
- Connect the equipment into an outlet on a circuit different from that to which the receiver is connected.
- Consult the dealer or an experienced radio/TV technician for help.

FCC Caution: To assure continued compliance, follow the attached installation instructions and use only shielded interface cables when connecting to peripheral devices.

Any changes or modifications not expressly approved by the party responsible for compliance could void the user's authority to operate this equipment.

This device complies with Part 15 of the FCC Rules. Operation is subject to the following two conditions: (1) This device may not cause harmful interference, and (2) this device must accept any interference received, including interference that may cause undesired operation.

Declaration of Conformity

Trade Name:	Panasonic
Model No.:	HC-MDH3
Responsible Party:	Panasonic Corporation of North America Two Riverfront Plaza, Newark, NJ 07102-5490
Support Contact:	http://shop.panasonic.com/support



THE FOLLOWING APPLIES ONLY IN CANADA.

CAN ICES-3(B)/NMB-3(B)

(For the U.S.A. and Canada only)

AC adaptor

This AC adaptor operates on AC between 100 V and 240 V.

But

- In the U.S.A. and Canada, the AC adaptor must be connected to a 120 V AC power supply only.
- When connecting to an AC supply outside of the U.S.A. or Canada, use a plug adaptor to suit the AC outlet configuration.
- When connecting to a supply of greater than AC 125 V, ensure the cord you use is suited to the voltage of the AC supply and the rated current of the AC adaptor.
- Contact an electrical parts distributor for assistance in selecting a suitable AC plug adaptor or AC cord set.

The power plug is the disconnecting device. Install this unit so that the power plug can be unplugged from the socket outlet immediately.

(Except for the U.S.A. and Canada)

The mains plug is the disconnecting device. Install this unit so that the mains plug can be unplugged from the socket outlet immediately.

This unit is intended for use in moderate climates.

IMPORTANT SAFETY INSTRUCTIONS

Read these operating instructions carefully before using the unit. Follow the safety instructions on the unit and the applicable safety instructions listed below. Keep these operating instructions handy for future reference.

- 1) Read these instructions.
- 2) Keep these instructions.
- 3) Heed all warnings.
- 4) Follow all instructions.
- 5) Do not use this apparatus near water.
- 6) Clean only with dry cloth.
- 7) Do not block any ventilation openings. Install in accordance with the manufacturer's instructions.
- 8) Do not install near any heat sources such as radiators, heat registers, stoves, or other apparatus (including amplifiers) that produce heat.
- 9) Do not defeat the safety purpose of the polarized or grounding-type plug. A polarized plug has two blades with one wider than the other. A grounding-type plug has two blades and a third grounding prong. The wide blade or the third prong are provided for your safety. If the provided plug does not fit into your outlet, consult an electrician for replacement of the obsolete outlet.
- 10) Protect the power cord from being walked on or pinched particularly at plugs, convenience receptacles, and the point where they exit from the apparatus.
- 11) Only use attachments/accessories specified by the manufacturer.
- 12) Use only with the cart, stand, tripod, bracket, or table specified by the manufacturer, or sold with the apparatus. When a cart is used, use caution when moving the cart/apparatus combination to avoid injury from tip-over.
- 13) Unplug this apparatus during lightning storms or when unused for long periods of time.
- 14) Refer all servicing to qualified service personnel. Servicing is required when the apparatus has been damaged in any way, such as power-supply cord or plug is damaged, liquid has been spilled or objects have fallen into the apparatus, the apparatus has been exposed to rain or moisture, does not operate normally, or has been dropped.



■ Concerning the battery

Battery pack (Lithium ion battery pack)

- Use the specified unit to recharge the battery pack.
- Do not use the battery pack with equipment other than the specified unit.
- Do not get dirt, sand, liquids, or other foreign matter on the terminals.
- Do not touch the plug terminals (+ and -) with metal objects.
- Do not disassemble, remodel, heat or throw into fire.

If any electrolyte should come into contact with your hands or clothes, wash it off thoroughly with water.

If any electrolyte should come into contact with your eyes, never rub the eyes. Rinse eyes thoroughly with water, and then consult a doctor.

Warning

Risk of fire, explosion and burns. Do not disassemble, heat above 60 °C (140 °F) or incinerate.

CAUTION

- Danger of explosion if battery is incorrectly replaced. Replace only with the type recommended by the manufacturer.
- When disposing of the batteries, please contact your local authorities or dealer and ask for the correct method of disposal.

■ Product identification marking

Product	Location
High Definition Video Camera	Bottom
AC adaptor	Bottom

Conforms to UL STD 60065.

Certified to CAN/CSA STD C22.2 No.60065.

■ Cautions for use

About this unit

The unit and the SD card become warm during use. This is not a malfunction.

Keep this unit as far away as possible from electromagnetic equipment (such as microwave ovens, TVs, video games etc.).

- If you use this unit on top of or near a TV, the pictures and/or sound on this unit may be disrupted by electromagnetic wave radiation.
- Do not use this unit near cell phones because doing so may result in noise adversely affecting the pictures and/or sound.
- Recorded data may be damaged, or pictures may be distorted, by strong magnetic fields created by speakers or large motors.
- Electromagnetic wave radiation generated by microprocessors may adversely affect this unit, disturbing the pictures and/or sound.
- If this unit is adversely affected by electromagnetic equipment and stops functioning properly, turn this unit off and remove the battery or disconnect AC adaptor. Then reinsert the battery or reconnect AC adaptor and turn this unit on.

Do not use this unit near radio transmitters or high-voltage lines.

- If you record near radio transmitters or high-voltage lines, the recorded pictures and/or sound may be adversely affected.

About using a headphone

- Excessive sound pressure from earphones and headphones can cause hearing loss.
- Listening at full volume for long periods may damage the user's ears.

Make sure to use the supplied cords and cables. If you use optional accessories, use the cords and the cables supplied with them.

Do not extend the cords and the cables.

Do not spray insecticides or volatile chemicals onto the unit.

- If the unit is sprayed with such chemicals, its body may be marred and the surface finish may peel off.
- Do not leave rubber or plastic products in contact with the unit for a long time.

When you use the unit in a sandy or dusty place such as a beach, do not let sand or fine dust get into the body and terminals of the unit.

Also, keep the unit away from sea water.

- Sand or dust may damage the unit. (Care should be taken when inserting and removing a card.)
- If sea water splashes onto the unit, wipe off the water with a well wrung cloth. Then wipe the unit again with a dry cloth.

When carrying the unit, do not drop or bump it.

- A strong impact can break the unit's casing, causing it to malfunction.
- When carrying this unit, please hold the handle, grip belt or shoulder strap firmly and treat it with care.

Cleaning

- Before cleaning, detach the battery or pull the AC cable from the AC outlet, and then wipe the unit with a soft, dry cloth.
- If the unit is very dirty, dip a cloth in water and squeeze firmly, and then wipe the unit with the damp cloth. Next, dry the unit with a dry cloth.
- Use of benzene, paint thinner, alcohol, or dishwashing liquid may alter the camera body or peel the surface finish. Do not use these solvents.
- When using a chemical dust cloth, follow the instructions that came with the cloth.

When you are not going to use the unit for an extended time

- When storing the unit, it is recommended that you place a desiccant (silica gel) in with it.

Do not lift up this unit by the handle with the tripod still attached

- When the tripod is attached, its weight will also affect the unit's handle, possibly causing the handle to break and hurting the user.
- To carry the unit while the tripod is attached, take hold of the tripod.

Do not swing the unit around, shake it by, or allow it hang from the handle

- Do not jar, swing, or shake the unit by its handle. Any strong jolt to the handle may damage the unit or result in personal injury.

Do not allow the cord to drag on the ground or pull a connected cord along the passage

- The cord will be damaged, causing fire or electrical shock, when the cord gets caught by the feet, excite will also cause personal injury.

Do not look at the light-emitting portion of the built-in LED light directly while the light is turned on.

Do not bring the portion close to human eyes and turn on the light.

- The bright light may hurt the eyes.

Do not touch the light-emitting portion of the built-in LED light directly with your hands.

Do not use the built-in LED light if there is dust or other foreign matter on it.

Do not cover the built-in LED light with an object such as tape.

- Doing so may cause burns.
- Do not touch the built-in LED light for a while even after turning it off.
- Hold both the left and right sides of the supplied filter to remove it.

About the battery

The battery used in this unit is a rechargeable lithium-ion battery. It is susceptible to humidity and temperature and the effect increases the more the temperature rises or falls. In cold areas, the full charge indication may not appear or the low battery indication may appear about 5 minutes after starting use. At high temperatures, the protection function may be triggered, making it impossible to use the unit.

Be sure to detach the battery after use.

- If the battery is left attached, a minute amount of current continues to flow even if the unit is off. Keeping the unit in this state may result in over discharge of the battery. This may result in you not being able to use the battery even after it is charged.
- The battery should be stored in the vinyl bag so metal does not come into contact with the terminals.
- The battery should be stored in a cool place free from humidity, with as constant temperature as possible. (Recommended temperature: 15 °C to 25 °C (59 °F to 77 °F), Recommended humidity: 40%RH to 60%RH)
- Extremely high temperatures or low temperatures will shorten the life of the battery.
- If the battery is kept in high-temperature, high-humidity, or oily-smoky places, the terminals may rust and cause malfunctions.
- To store the battery for a long period of time, we recommend you charge it once every year and store it again after you have completely used up the charged capacity.
- Dust and other matter attached to the battery terminals should be removed.

Prepare spare batteries when going out for recording.

- Prepare batteries enough to last for 3 to 4 times the period you are planning to record for. Cold places such as a ski resort can shorten recording time.

If you drop the battery accidentally, check to see if the terminals are damaged.

- When this unit is attached with the terminal part in a deformed state, this unit may be damaged.

Do not throw old battery into fire.

- Heating a battery or throwing it into a fire may result in an explosion.

If the operating time is very short even after the battery has been recharged, the battery has worn out. Please purchase a new battery.

About the AC adaptor

- If the temperature of the battery is extremely high or extremely low, charging may take time or the battery may not be charged.
- If you use the AC adaptor near a radio, radio reception may be disturbed. Keep the AC adaptor 1 m (3.3 feet) or more away from the radio.
- When using the AC adaptor, it may generate whirring sounds. However, this is normal.
- After use, be sure to disconnect the AC cable from the AC outlet. (If you leave this unit connected, the AC adaptor will consume approximately 0.3 W.)
- Always keep the electrodes of the AC adaptor and battery clean.
- **Install the device near an AC outlet so that the power disconnection device (AC mains plug) can be accessed easily by hand.**

About charging lamp during charging

When the charging lamp is flashing, the following should be considered.

Flashing with approx. 4 second period (off for approx. 2 seconds, on for approx. 2 seconds):

- When the battery is over discharged or the temperature of the battery is too high or low. It can be charged, but it may take a few hours to complete the charging normally.
- Once normal charging starts, the charging lamp lights up green. However, depending on the conditions of use, even when normal charging is taking place, the charging lamp may keep flashing in approx. 4 second intervals until charging is completed.

Flashing with approx. 0.5 second period (off for approx. 0.25 second, on for approx.

0.25 second):

- The battery is not charged. Remove the battery from the unit, and try charging again.
- Check that the terminals of the unit or battery are not dirty or covered with a foreign object, and connect the battery correctly once again. If a foreign object or dirt is present, turn off the unit before removing.
- The battery or environment is at an extremely high or low temperature. Wait until the temperature has returned to an appropriate level and try charging again. If you are still unable to charge, there may be a fault in the unit, battery or AC adaptor.

Off:

- Charging has finished.
- If the status indicator stays off despite the charging being unfinished, there may be a fault in the unit, battery or AC adaptor. Refer to page 8 for details on the battery.

About the SD card

When disposing of or giving away the SD card, note that:

- Formatting and deletion of this unit or computer only changes the file management information and does not completely delete the data in the SD card.
- It is recommended that the main SD card is either physically destroyed or the SD card is physically formatted using this unit when disposing of or giving away the SD card.
- To physically format, connect this unit to the AC adaptor, select [OTHER FUNCTION] → [FORMAT MEDIA] → [SD CARD 1] or [SD CARD 2] from the menu, and touch [YES]. Press and hold recording start/stop button in the following screen for three seconds. Screen to delete the SD card data is displayed, so select [YES] and follow the instruction on the screen.

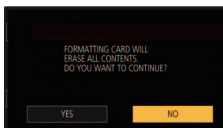

- The customer is responsible for the management of the data in the SD card.

LCD monitor/viewfinder

- When the LCD screen is dirty or condensation has occurred, please wipe it using a soft cloth such as a lens cloth.
- Do not touch the LCD monitor with your finger nails, or rub or press with strong force.
- It may become hard to see or hard to recognize the touch when the LCD protection sheet is affixed.
- When the unit has become very cold, for example due to storage in a cold area, its LCD monitor will be slightly darker than usual immediately after the unit is turned on. The normal brightness will be restored when the unit's internal temperature rises.

Extremely high precision technology is employed to produce the LCD Monitor screen. The result is more than 99.99% effective dots with a mere 0.01% of the dots inactive or always lit. However, this is not a malfunction and does not affect the recorded picture.

Extremely high precision technology is employed to produce the viewfinder screen. The result is more than 99.99% effective dots with a mere 0.01% of the dots inactive or always lit. However, this is not a malfunction and does not affect the recorded picture.

■ About the recording method for recording motion pictures

This unit can record motion pictures using three different recording methods, including MOV, MP4 and AVCHD.

* AVCHD Progressive (1080/60p) supported.

MOV and MP4:

These recording methods are suitable for editing images. Audio is recorded in linear PCM.

- Those methods are not compatible with motion pictures recorded in AVCHD format.

AVCHD:

This recording method is suitable for playback on a high-definition TV.

Audio is recorded in Dolby Audio™.

■ Indemnity about recorded content

Panasonic does not accept any responsibility for damages directly or indirectly due to any type of problems that result in loss of recording or edited content, and does not guarantee any content if recording or editing does not work properly. Likewise, the above also applies in a case where any type of repair is made to the unit.

■ About Condensation (When the lens, the viewfinder or LCD Monitor is fogged up)

Condensation occurs when there is a change in temperature or humidity, such as when the unit is taken from outside or a cold room to a warm room. Please be careful, as it may cause the lens, the viewfinder or LCD monitor to become soiled, moldy, or damaged.

When taking the unit to a place which has a different temperature, if the unit is accustomed to the room temperature of the destination for about one hour, condensation can be prevented. (When the difference in temperature is severe, place the unit in a plastic bag or the like, remove air from the bag, and seal the bag.) When condensation has occurred, remove the battery and/or the AC adaptor and leave the unit like that for about one hour. When the unit becomes accustomed to the surrounding temperature, fogginess will disappear naturally.

■ About security

Be careful about the possibility of theft or loss of the unit, and be careful not to leave the unit unattended. Please note that Panasonic does not accept any responsibility for the compromise, manipulation, and loss of information caused by these events.

■ Caution regarding laser beams

The lens may suffer damage if struck by a laser beam. Make sure that laser beams do not strike the lens when shooting in an environment where laser devices are used.

■ Caution regarding the lens and the viewfinder



Do not aim the lens or viewfinder at the sun or strong light. Doing so may cause the unit to malfunction.

■ Cards that you can use with this unit

SDHC Memory Card and SDXC Memory Card

- 4 GB or more Memory Cards that do not have the SDHC logo or 48 GB or more Memory Cards that do not have the SDXC logo are not based on SD Memory Card Specifications.
- Refer to page 26 for more details on SD cards.

■ For the purposes of this owner's manual

- The battery pack is referred to as the "Battery".
- SDHC Memory Card and SDXC Memory Card are referred to as the "SD card".
- Function that can be used for Recording Mode: 
Function that can be used for Playback Mode: 
- Scene(s) recorded with [REC MODE] set to [MOV] or [MP4]: "MOV/MP4 scene(s)".
- Scene(s) recorded with [REC MODE] set to [AVCHD]: "AVCHD scene(s)".
- Notation of < > indicates the setup item name of the USER button that can be set with the menu of [USER SW]→[USER1] to [USER7].
- Pages for reference are indicated by an arrow, for example: → 00

Contents

Accessories	14
Optional accessories	15

Preparation

What you can do with this unit	16
Recording to the SD card	16
Linking to external devices	16
Names and Functions of Main Parts	18
Power supply	23
Inserting/removing the battery	23
Charging the battery	24
Charging and recording time	25
Preparation of SD cards	26
Cards that you can use with this unit	26
Inserting/removing an SD card	27
Turning the unit on/off	28
Selecting a mode	28
Using the LCD monitor/Viewfinder	29
Switching between the LCD monitor and viewfinder displays	29
How to use the touch screen	30
LCD monitor adjustment	31
Viewfinder adjustment	32
Recording yourself	33
Setting date and time	34
Using the menu screen	36

Recording

Before recording	37
Selecting a media to record	37
Formatting media	38
Recording motion picture	39
Recording still pictures	41
Intelligent Auto Mode/Manual Mode	42
Using the zoom	44
Using the Built-in LED Light	45
Manual Recording	46
Focus	47
One Push AF	48
Push AF	49
Focus Assist	49
Iris/Gain adjustment	53
Iris adjustment	53
Gain adjustment	54
White Balance	56
Manual shutter speed	59
Audio Input	61
Adjusting the audio input level	61
Counter display	63
Setting the Time Code	63

Setting the Recording Counter	65
USER button	66
Setting the USER button	66
Using the USER button	66
Functions of the USER button	67
Using Operation Icons	82
Switching the screen indications/ mode information display	82
Image Stabilizer Function	83
Color Bar Screen	83
Zebra	84
Using of jog dial	85

Playback

Motion picture/Still picture playback	88
Motion picture playback using operation icon	92
Useful functions	93
Creating still picture from motion picture	93
Repeat Playback	94
Resuming the previous playback	94
Playing back scenes or still pictures by date	95

Editing

Deleting scenes/still pictures	96
Protecting scenes/still pictures	97
Copying between SD cards	98

Linking to external devices

Connecting Headphones, a Remote Control or an External Monitor	100
Headphones	100
Remote control	100
TV	101
Setting the external output resolution	103
Importing to PC	105
About the PC display	105
Copying/playing back with an external media device	107
Preparing for copying/playing back	107
Differential copy	109
Copy selected files	110
Playing back the External Media	111
Dubbing with a Blu-ray disc recorder, video device, etc.	112

Menu

Using the Menu	114
Camera Setup	114
System mode	117
User switch	121
Switch setting	122
Recording Setup	125
Audio Setup	128
Output Setup	129
Display setting	131
Other Functions	136
Maintenance	139
Video Setup	140
Picture Setup	141
Copy	141

Display

Indications	142
Messages	145
Warning Indications	147

Others

Troubleshooting	149
About recovery	152
About copyright	153
Recording functions that cannot be used simultaneously	154
Recording modes/approximate recordable time	155
Approximate number of recordable pictures	156
Specification	157
Useful Information (Only For Latin American Countries)	159

Accessories

Check the accessories before using this unit.

Keep the accessories out of reach of children to prevent swallowing.

Product numbers correct as of Mar. 2018. These may be subject to change.

Battery pack

VW-VBD29



AC adaptor

SAE0011



AC cable

K2CA2YY00259



Eyecup (→ 22)

VYC1080



Lens cap (→ 21)

SYA0073



Diffusion filter (white)

(→ 45)

1ZE1HCMDH3GCZ



(For U.S.A. only)







If accessories are lost, customers can visit us at

<http://shop.panasonic.com/support>

for further information about obtaining replacement parts.

Optional accessories

Some optional accessories may not be available in some countries.

Accessory No.	Figure	Description
VW-VMS10		Stereo microphone
AG-BRD50		Battery charger
VW-VBD58		Battery pack
AG-VBR59		Battery pack
AG-VBR89		Battery pack
VW-LF49N		Filter kit

(For U.S.A. only)

To order optional accessories please visit <http://shop.panasonic.com> or your local Photo Specialty Dealer.

NOTE:

Accessories and/or model numbers may vary by country. Please consult your local dealer. Product numbers correct as of Mar. 2018. These may be subject to change.

Attaching the Filter Kit

Attach the ND Filter and MC Protector of the VW-LF49N Filter Kit to the front side of the lens.

Be careful about the following.

Although two accessory items, such as ND filters, can be fitted one behind the other, this is not recommended as it may darken the four corners of the screen (vignetting) when the zoom lever is pressed toward the W side.

What you can do with this unit

Recording to the SD card

It is possible to record motion pictures and still pictures to the SD card (SDHC Memory Card/SDXC Memory Card) using a variety of recording functions.

- This unit supports relay/simultaneous recording using double card slots.

Linking to external devices

Using an external media device for copying/playback

If you connect an external media device, such as USB HDD or USB flash memory (commercially-available) to this unit, you can copy motion pictures and still pictures recorded on this unit to the external media device.

It can also play back the scenes and still pictures copied to the external media device.

- This unit supports USB 2.0.
- Use the USB cable supplied with a USB HDD.

If possible, we recommend using a cable with a length of 1.5 m (4.9 feet) or less.

Refer to the following support site for information about an external media device.

http://panasonic.jp/support/global/cs/e_cam

(This Site is English only)

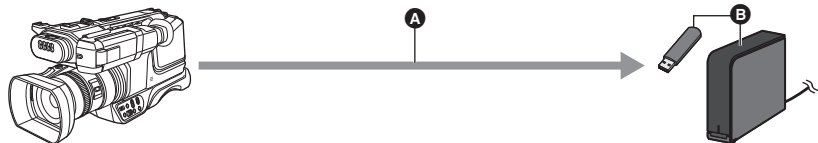

- A** USB 2.0
- B** External media device (commercially-available)

Importing data to a PC

Image data can be imported to a PC for editing by inserting the SD card used for recording with the unit into that PC.

- A PC with an SD card slot or an SD card reader is required.

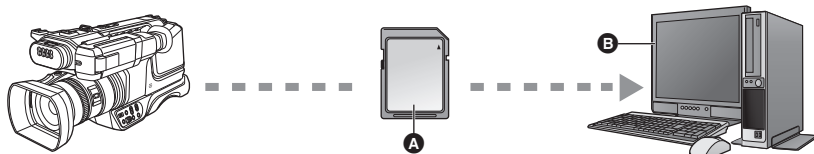

- A** SDHC Memory Card/SDXC Memory Card*
- B** PC

* SD cards are optional and not supplied with this unit.

Connecting to a TV

Connect a TV to output images.

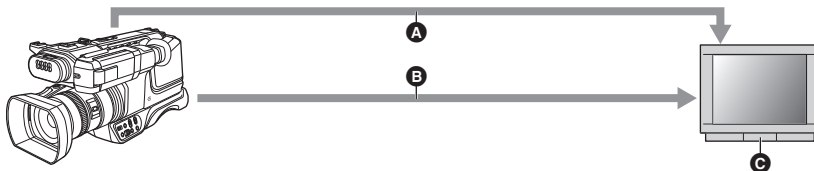

- A** AV cable (commercially-available)
- B** HDMI cable (commercially-available)
- C** TV

- Use a commercially-available AV cable.
- Use a commercially-available High Speed HDMI cable.
If possible, we recommend using a cable with a length of 3 m (9.84 feet) or less.

When connecting with an HDMI cable using an HDMI-to-DVI converter, etc., be sure to connect the HDMI cable to the connector of this unit last. Connecting the HDMI cable to the connector of this unit first may result in malfunction.

Names and Functions of Main Parts

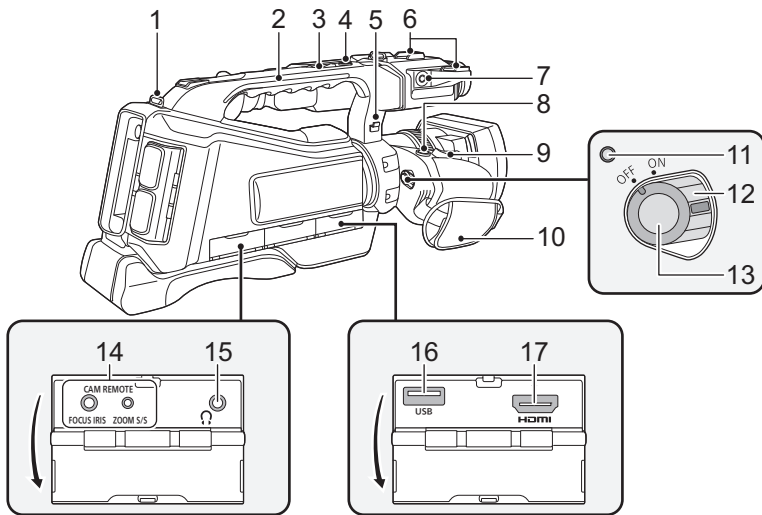

1 Shoulder strap fixture

2 Handle

3 Sub zoom lever (→ 44, 124)

- This lever functions in the same manner as the zoom lever.
- The zoom speed is controlled with this lever in a way different from the way it is controlled with the zoom lever. (→ 44)

4 Sub recording start/stop button (→ 124)

- This button functions in the same manner as the recording start/stop button.

5 Microphone cable holder

- You can fasten the excess cable by tucking it into the cable holder.

6 Accessory shoe

7 External microphone terminal [EXT MIC]

- A compatible plug-in powered microphone can be used as an external microphone.
- When the unit is connected with the AC adaptor, sometimes noise may be heard depending on the microphone type. In this case, please switch to the battery for the power supply and the noise will stop.

- Check that the unit is turned off. Connecting or removing the microphone while the unit is turned on may cause malfunction.

8 User 3 button [FOCUS ASSIST] (→ 66)

9 Zoom lever [T/W] (In Recording Mode) (→ 44)

Volume lever [+VOL-]/

Thumbnail display switch [Q/] (In Playback Mode) (→ 90)

10 Grip belt (→ 21)

11 Status indicator (→ 28)

12 Power switch (→ 28)

13 Recording start/stop button (→ 39)

14 Camera remote terminal [CAM REMOTE] (→ 100)

- FOCUS IRIS terminal (3.5 mm (0.14 ") diameter mini jack)
- ZOOM S/S terminal (2.5 mm (0.1 ") diameter super mini jack)

15 Headphone terminal [] (→ 87, 100)

16 USB terminal (→ 107)

17 HDMI out terminal [HDMI] (→ 101)

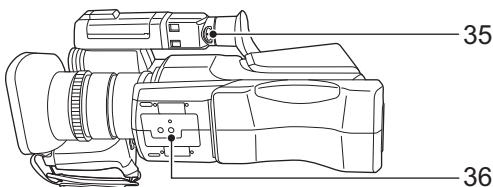
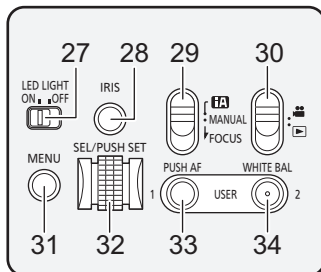
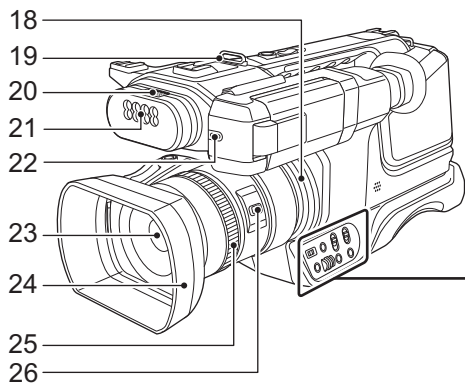

- 18 Ring LED (→ 136)
- 19 Shoulder strap fixture
- 20 Built-in microphone
- 21 Built-in LED light (→ 45)
- 22 Recording lamp (→ 136)
- 23 Lens
- 24 Lens hood
- 25 Multi-manual ring (→ 46)
- 26 Camera function button [CAMERA FUNCTION] (→ 46)
- 27 LED LIGHT switch (→ 45)
- 28 Iris button [IRIS] (→ 53)
- 29 Intelligent auto/Manual/Focus switch [i/MANUAL/FOCUS] (→ 42)
- 30 Mode switch [/] (→ 28)
- 31 Menu button [MENU] (→ 36)
- 32 Jog dial [SEL/PUSH SET] (→ 54, 56, 59, 85, 90)
- 33 USER1 button [PUSH AF] (→ 66)
- 34 USER2 button [WHITE BAL] (→ 66)
- 35 Eyepiece corrector lever (→ 32)
- 36 Tripod receptacle

- Attaching a tripod with a screw length of 5.5 mm (0.22") or more may damage the unit.

- There are tripod receptacle that are compatible with 1/4-20UNC screws.

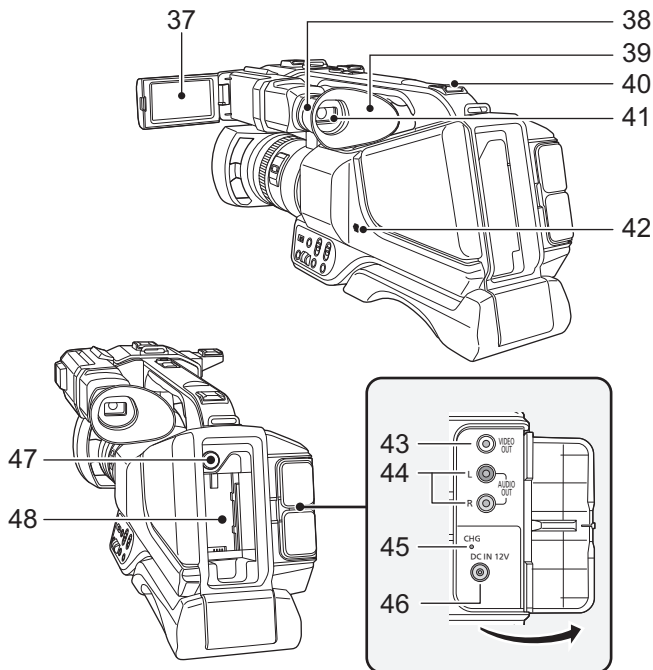

37 LCD monitor (Touch screen) (→ 30)

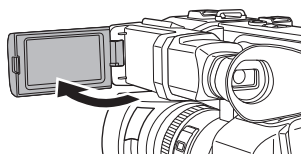

- It can open up to 90°.

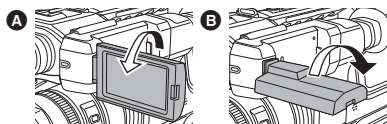

- It can rotate up to 180° **A** towards the lens or 90° **B** towards the opposite direction.

38 Eyecup mount (→ 22)

39 Eyecup (→ 22)

40 Accessory shoe

41 Viewfinder (→ 32)

- Extend the viewfinder before use.

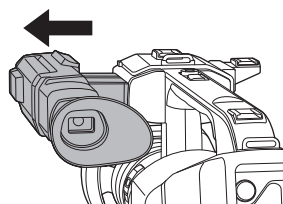

42 Speaker

43 VIDEO OUT terminal (→ 101)

44 AUDIO OUT terminal (→ 101)

45 Charging lamp [CHG] (→ 24)

46 DC input terminal [DC IN] (→ 24)

47 Battery release button [PUSH] (→ 23)

48 Battery holder (→ 23)

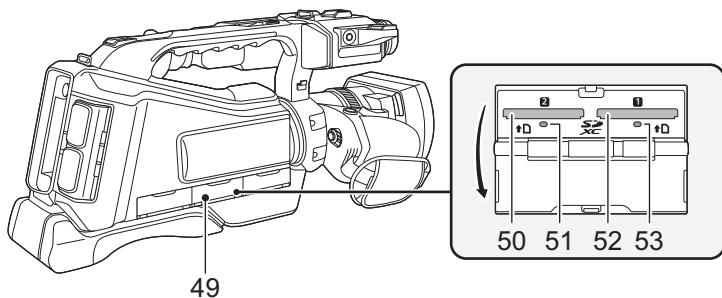

49 SD Card slot cover (→ 27)

50 Card slot 2 (→ 27)

51 Access lamp (card 2) (→ 27)

52 Card slot 1 (→ 27)

53 Access lamp (card 1) (→ 27)

■ Attaching/removing the lens cap

Protect the lens surface with the lens cap while the unit is not used.

- Place your fingers in the recesses on the lens cap to hold it when attaching or removing it.
- To attach the lens cap, align its projections horizontally, and then push them into the slits on the lens hood until a clicking sound is heard.

- A** Slits
- B** Projections

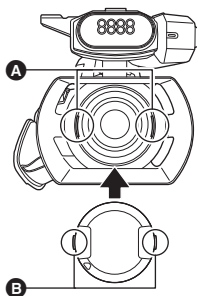

■ Adjust the length of the grip belt so that it fits your hand.

Adjust the grip belt according to the size of your hand.

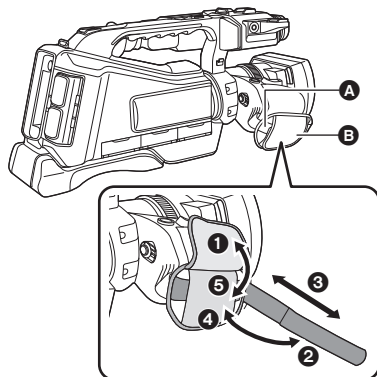

- A** Belt
- B** Belt cover

- 1, 2** Flip the belt cover and the belt.
- 3** Adjust the length.
- 4, 5** Replace the belt.

■ Attaching the eyecup

Attach by aligning the notch of the eyecup attachment part with the protrusion at the inside of the eyecup.

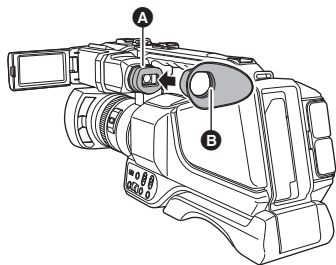

- A** Notch
- B** Protrusion

Power supply

■ About batteries that you can use with this unit (as of March 2018)

The battery that can be used with this unit is VW-VBD29/VW-VBD58/AG-VBR59/AG-VBR89.

It has been found that counterfeit battery packs which look very similar to the genuine product are made available to purchase in some markets. Some of these battery packs are not adequately protected with internal protection to meet the requirements of appropriate safety standards. There is a possibility that these battery packs may lead to fire or explosion. Please be advised that we are not liable for any accident or failure occurring as a result of use of a counterfeit battery pack. To ensure that safe products are used we would recommend that a genuine Panasonic battery pack is used.

Inserting/removing the battery

Install the battery by inserting it in the direction shown in the figure.

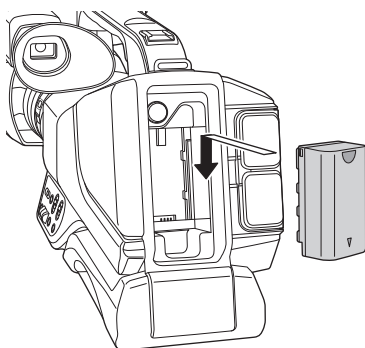

Insert the battery until it clicks and locks.

Removing the battery

Make sure that the power switch is set to OFF and the status indicator is turned off, and then remove by holding onto it taking care not to drop. (→ 28)

While pressing the battery release button, remove the battery.

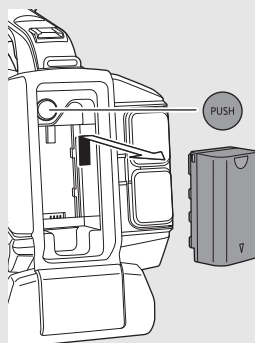

Charging the battery

When this unit is purchased, the battery is not charged. Charge the battery fully before using this unit for the first time.

The unit is in the standby condition when the AC adaptor is connected. The primary circuit is always "live" as long as the AC adaptor is connected to an electrical outlet.

Important:

- Use the supplied AC adaptor. Do not use the AC adaptor of another device.
- Do not use the AC cable with any other equipment as it is designed only for this unit. Also, do not use the AC cable from other equipment with this unit.
- The battery can be charged while the unit is turned off. In Playback Mode, the battery can be charged even while the unit is turned on.
- It is recommended to charge the battery in a temperature between 10 °C and 30 °C (50 °F and 86 °F). (The battery temperature should also be the same.)

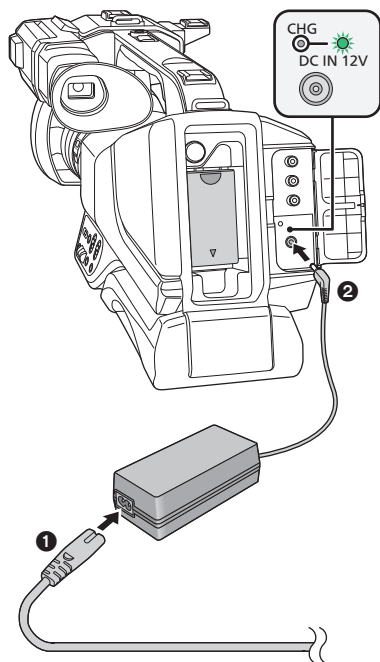

1 Connect the AC cable to the AC adaptor and the AC outlet.

- Insert the plugs as far as they will go.

2 Connect the AC adaptor to the DC input terminal [DC IN].

- As the charging lamp lights up green, charging starts. It will turn off when the charging is completed.
- If the charging lamp flashes, refer to page 9.

■ Connecting to the AC outlet

It is possible to use this unit with power supplied from the AC outlet by turning on the unit with the AC adaptor connected.

Even when you use the AC adaptor for recording images, keep the battery connected. This allows you to continue the recording even if a power failure occurs or the AC adaptor is unplugged from the AC outlet by accident.

- Do not use any other AC adaptors except the supplied one.
- We recommend using Panasonic batteries (→ 25).
- If you use other batteries, we cannot guarantee the quality of this product.
- Do not heat or expose to flame.
- Do not leave the battery(ies) in a car exposed to direct sunlight for a long period of time with doors and windows closed.

Charging and recording time

Charging/Recording time

- The times given apply when the ambient operating temperature is 25 °C (77 °F) and the relative operating humidity is 60%. Charging time may be longer at other temperatures and humidity levels.
- These charging times are for when the unit is turned off.
- The maximum continuous recordable times and the actual recordable times are based on the conditions below. These become shorter in other conditions.
 - When [REC MODE] is set to [AVCHD] and [REC FORMAT] is set to [PH 1080/59.94i]
 - When using the viewfinder (times in parentheses are when using the LCD monitor)
 - A cable is not inserted to the external output terminal

Battery model number	Voltage/Capacity (minimum)	Time required to charge this unit	Maximum continuous recordable time	Actual recordable time
Supplied battery (VW-VBD29)	7.2 V/2900 mAh	3 h 15 min	4 h 35 min (4 h 35 min)	2 h 25 min (2 h 25 min)
VW-VBD58 (optional)	7.2 V/5800 mAh	5 h 15 min	9 h 30 min (9 h 30 min)	5 h (5 h)
AG-VBR59 (optional)	7.28 V/5900 mAh	5 h 30 min	9 h 30 min (9 h 30 min)	5 h (5 h)
AG-VBR89 (optional)	7.28 V/8850 mAh	8 h 5 min	14 h 20 min (14 h 25 min)	7 h 35 min (7 h 35 min)





- "h" is an abbreviation for hour, "min" for minute and "s" for second.
- These times are approximations.
- **The indicated charging time is for when the battery has been discharged completely. Charging time and recordable time vary depending on the usage conditions such as high/low temperature.**
- If this unit is turned on, charging may take longer than the values in the table above.

- The actual recordable time refers to the recordable time when repeatedly starting/stopping recording, turning the unit on/off, moving the zoom lever etc.
- The batteries heat up after use or charging. This is not a malfunction.

■ Batteries that support quick charging

For quick charging of a battery (AG-VBR59/AG-VBR89: optional), use a battery charger (AG-BRD50: optional).

Battery capacity indication

- The display changes as the battery capacity reduces. 
If the battery discharges, then  will flash red.
- If the unit is charged while it is turned on,  will be displayed on the screen.  will disappear after charging is complete.
- As long as the charging lamp is flashing, charging is not complete even after  has disappeared. For more details, please refer to page 9.
- Depending on the menu setting, the battery capacity indication is not displayed. (→ 134) [DISP SETUP] → [CARD & BATTERY]

Preparation of SD cards

The unit can record motion pictures or still pictures to an SD card.

Cards that you can use with this unit

- The cards that you can use are correct as of March 2018.
- We recommend that you use a Panasonic Memory Card.

Card type	Capacity
SDHC Memory Card	4 GB to 32 GB
SDXC Memory Card	48 GB to 128 GB

- **When using an SDHC Memory Card/SDXC Memory Card with other equipment, check the equipment is compatible with these Memory Cards.**
- We do not guarantee the operation of SD cards other than the ones above.
- 4 GB or more Memory Cards that do not have the SDHC logo or 48 GB or more Memory Cards that do not have the SDXC logo are not based on SD Memory Card Specifications.
- When the write-protect switch **A** on SD card is locked, no recording, deletion or editing will be possible on the card.
- Keep the Memory Card out of reach of children to prevent swallowing.

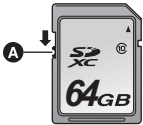

■ About the Speed Class ratings for recording motion pictures

- Depending on [REC MODE] (→ 117) and [REC FORMAT] (→ 118), the required card differs. Use a card that meets the following ratings of the SD Speed Class. Use of a non-compatible card may cause recording to stop suddenly.
- SD Speed Class is the speed standard regarding continuous writing. To check the class, see the labelled side, etc. of the card.

Recording modes	Recording function or Recording format	Speed Class ratings	Label examples
MOV/MP4	Super Slow Recording	Class10	CLASS 10
	50 Mbps		
AVCHD	All	Class4 or more	CLASS 4

Inserting/removing an SD card

When using an SD card for the first time, it is necessary to format the SD card. (→ 38) When the SD card is formatted, all of the recorded data is deleted. Once the data is deleted, it cannot be restored.

Caution:

Check that the access lamp has gone off.

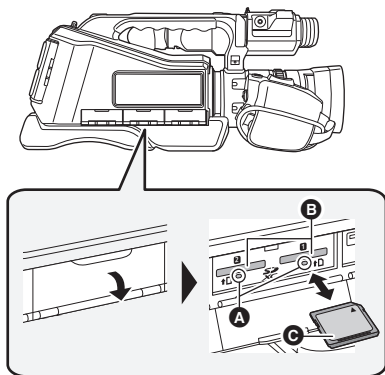

Access lamp **A**

- When this unit is accessing the SD card, the access lamp lights up.

1 Open the SD card slot cover and insert (remove) the SD card into (from) the card slot **B**.

- One SD card can be inserted into each of the card slot 1 and the card slot 2.
- Face the labelled side **C** in the direction shown in the illustration and press it straight in as far as it will go.
- Press the center of the SD card and then pull it straight out.

2 Securely close the SD card slot cover.

- Do not touch the terminals on the back of the SD card.
- Do not apply strong shocks, bend, or drop the SD card.
- Electrical noise, static electricity or the failure of this unit or the SD card may damage or erase the data stored on the SD card.
- When the card access lamp is lit, do not:
 - Remove the SD card
 - Turn the unit off
 - Insert and remove the USB Cable
 - Expose the unit to vibrations or shockPerforming the above while the lamp is on may result in damage to data/SD card or this unit.
- Do not expose the terminals of the SD card to water, dirt or dust.
- Do not place SD cards in the following areas:
 - In direct sunlight
 - In very dusty or humid areas
 - Near a heater
 - Locations susceptible to significant difference in temperature (condensation can occur.)
 - Where static electricity or electromagnetic waves occur
- To protect SD cards, return them to their cases when you are not using them.
- About disposing of or giving away the SD card. (→ 9)

Turning the unit on/off

Set the power switch to ON while pressing the lock release button **B** to turn on the unit.

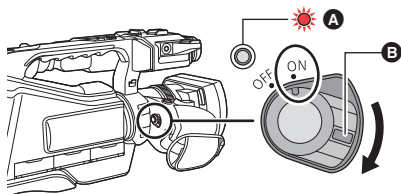

To turn off the unit

Set the power switch to OFF while pressing the lock release button. The status indicator goes off.



A The status indicator lights on.

- To turn on the unit again after the [ECONOMY (BATT)] or [ECONOMY (AC)] is activated, set the power switch to OFF once, and then to ON again. (→ 137)

Selecting a mode

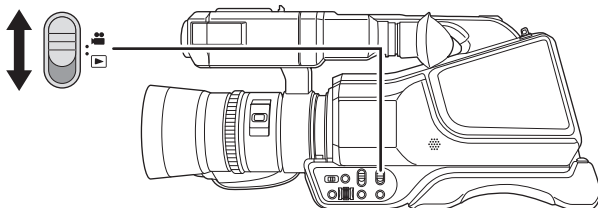
Slide the mode switch to  or .



 Recording Mode (→ 39, 41)	The recording screen is displayed. You can record motion pictures and still pictures.
 Playback Mode (→ 88)	The thumbnail screen for playback is displayed. You can play back motion pictures and still pictures.

Using the LCD monitor/Viewfinder

The viewfinder is turned off and the LCD monitor is turned on when the LCD monitor is opened.
The viewfinder is turned on when the LCD monitor is closed.

Switching between the LCD monitor and viewfinder displays

Select the menu. (→ 36)

 : [OUTPUT SETUP] → [LCD/EVF OUTPUT] → desired setting

[LCD]: The LCD monitor is turned on when the LCD monitor is opened. The viewfinder is not turned on.

[EVF]: The viewfinder turns on. The LCD monitor does not turn on.

■ To change the setting with a USER button

You can change how to display the LCD monitor and Viewfinder by registering <LCD/EVF OUTPUT> to a USER button.

- Please refer to page 66 for details about setting the USER button.

When the recording screen is displayed, press the USER button to which <LCD/EVF OUTPUT> is registered.

- Switches the setting each time the button is pressed.
[LCD] ↔ [EVF]
 - The setting is also applied to the [LCD/EVF OUTPUT] menu setting.
-
- [LCD] will be selected when the LCD monitor is opened.

How to use the touch screen

You can operate by directly touching the LCD monitor (touch screen) with your finger.

■ Touch

Touch and release the touch screen to select icon or picture.

- Touch the center of the icon.
- Touching the touch screen will not operate while you are touching another part of the touch screen.

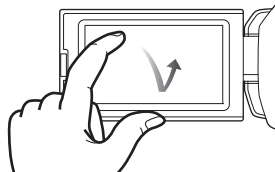

■ Slide while touching

Move your finger while pressing on the touch screen.

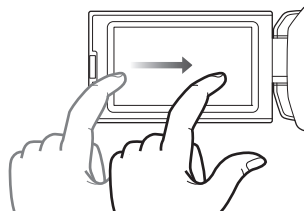

■ About the operation icons



Touch when changing a page or performing settings.



- Do not touch the LCD monitor with hard pointed tips, such as ball point pens.

LCD monitor adjustment

- These settings will not affect the images actually recorded.

[POWER LCD]

This makes it easier to view the LCD monitor in bright places including outdoors.

Select the menu. (→ 36)



: [DISP SETUP] → [POWER LCD] →

[+1] (Makes brighter)/[0] (Normal)/[-1] (Makes less bright)

- When the AC adaptor is in use, [POWER LCD] is set to [+1] automatically.
- [POWER LCD] will be automatically fixed to [0] when the built-in LED light is turned on, even if it is set to [+1].
- This item is not available while the LCD monitor is turned off. (→ 29)

[LCD SET]

It adjusts brightness and color density on the LCD monitor.

1 Select the menu. (→ 36)



: [DISP SETUP] → [LCD SET]

2 Touch the desired setting item.

[COLOR]:	Color level of the LCD monitor
[BRIGHTNESS]:	Brightness of the LCD monitor
[CONTRAST]:	Contrast of the LCD monitor

3 Touch  /  to adjust settings.

- You can select a value between -16 and +16.

4 Touch [RETURN].

- Touch [EXIT] to exit the menu screen.

- This item is not available while the LCD monitor is turned off. (→ 29)

Viewfinder adjustment

- These settings will not affect the images actually recorded.

Adjusting the field of view

It adjusts the field of view to show the image on the viewfinder clearly.

1 Adjust the viewfinder to suit your vision so that you can see the display images clearly.

- Be careful not to trap your fingers when moving the viewfinder.
- The viewfinder can be lifted vertically up to approximately 90°.
- Close the LCD monitor and turn on the viewfinder.

2 Adjust the focus by operating the eyepiece corrector lever **A**.

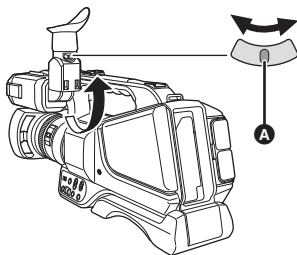

[EVF SET]

Brightness of the viewfinder can be switched.

Select the menu. (→ 36)



: [DISP SETUP] → [EVF SET] → [BRIGHT]/[NORMAL]/[DARK]

[EVF COLOR]

The recording images or playback images on the viewfinder can be selected between color/black and white.

Select the menu. (→ 36)



: [DISP SETUP] → [EVF COLOR] → [ON] or [OFF]

[ON]: Displayed in color

[OFF]: Displayed in black and white

Recording yourself

- Change the mode to Recording Mode. (→ 28)

Rotate the LCD monitor towards the lens side.

- Displaying during the recording yourself can be switched by setting [SELF SHOOT]. (→ 134)

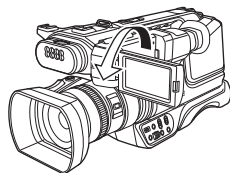

-
- Only some indications will appear on the screen when the [SELF SHOOT] is set to [MIRROR]. When  appears, return the direction of the LCD monitor to normal position and check the warning/alarm indication. (→ 145)
 - The LCD monitor remains turned off while the viewfinder is turned on.

Setting date and time

When this unit is turned on, the message [SET TIME ZONE AND DATE/TIME] may appear. To make these settings, select [YES], and follow the instructions from Steps 2-3 of the time zone setting procedure.

Time zone

Time difference from the Greenwich Mean Time can be set.

1 Select the menu. (→ 36)

 : [OTHER FUNCTION] → [TIME ZONE]

2 Touch / and set the region to record.

3 Touch [EXIT] to complete the setting.

- If the [CLOCK SET] screen appears, perform [CLOCK SET].

- When the time zone setting is changed, the date/time setting of the unit also changes automatically.

Clock setting

1 Select the menu. (→ 36)

 : [OTHER FUNCTION] → [CLOCK SET]

2 Touch the date or time to be set, then set the desired value using / .

- The year can be set between 2000 and 2039.

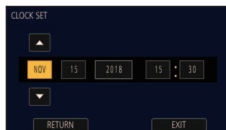

3 Touch [EXIT] to complete the setting.

- The date and time function is driven by a built-in lithium battery.
- If the time display becomes [- -], the built-in lithium battery needs to be charged. To recharge the built-in lithium battery, connect the AC adaptor or attach a charged battery to this unit. Leave the unit as it is for approx. 24 hours and the battery will maintain the date and time for approx. 6 months. (The battery is still being recharged even if the unit is off.)
- The way that time is displayed can be changed in the menu settings. (→ 133)
[DISP SETUP] → [DATE/TIME] or [DATE FORMAT]

■ Time zone table

Time difference	Region	Time difference	Region
0:00	London, Casablanca	+3:30	Tehran
-1:00	Azores	+4:00	Dubai, Abu Dhabi
-2:00	Fernando de Noronha	+4:30	Kabul
-3:00	Rio de Janeiro, Sao Paulo, Buenos Aires	+5:00	Islamabad, Karachi, Male
-3:30	Newfoundland	+5:30	Delhi, Kolkata, Mumbai, Chennai, Colombo
-4:00	Manaus, La Paz	+5:45	Kathmandu
-4:30	Caracas	+6:00	Dhaka
-5:00	Toronto, New York, Miami, Lima	+6:30	Yangon
-6:00	Chicago, Houston, Mexico City	+7:00	Bangkok, Jakarta
-7:00	Denver, Phoenix	+8:00	Beijing, Hong Kong, Kuala Lumpur, Singapore
-8:00	Vancouver, Seattle, Los Angeles	+9:00	Seoul, Tokyo
-9:00	Alaska, Anchorage	+9:30	Adelaide
-10:00	Hawaii, Honolulu, Tahiti	+10:00	Guam, Sydney
-11:00	Midway Islands	+11:00	Solomon Islands, New Caledonia
+1:00	Berlin, Paris, Rome, Madrid	+12:00	Fiji, Auckland, Wellington
+2:00	Helsinki, Athens, Cairo, Johannesburg	+12:45	Chatham Islands
+3:00	Moscow, Kuwait, Riyadh, Nairobi		

Using the menu screen

- You can also select menu items by operating the jog dial. (→ 85)

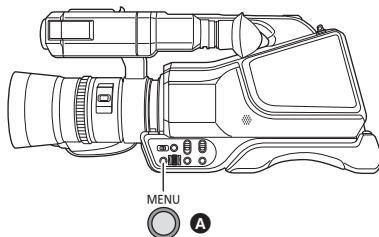

1 Press the MENU button **A**.

2 Touch the top menu **B**.

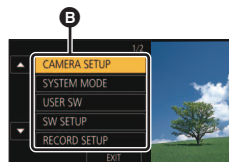

3 Touch the submenu **C**.

- Next (Previous) page can be displayed by touching ▲ / ▼.

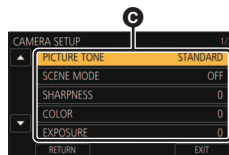

4 Touch the desired item to enter the setting.

5 Touch [EXIT] to exit the menu setting.

Before recording

- When recording, make sure your footing is stable and there is no danger of colliding with another person or object.
- Hold the eyecup of the viewfinder as close as possible to your eye.
- Adjust the angle of the LCD monitor according to the position in which the unit is held.
- When you are outdoors, record pictures with the sunlight behind you. If the subject is backlit, it will become dark in the recording.
- Keep your arms near your body and separate your legs for better balance.
- For stable images, it is recommended to use a tripod whenever possible.



Selecting a media to record

[SD CARD 1] and [SD CARD 2] can be selected separately to record motion pictures or still pictures.

1 Select the menu.

 : [RECORD SETUP] → [MEDIA SELECT]

2 Touch the media to record motion pictures or still pictures.

- The media is selected separately for motion pictures or still pictures and is then highlighted in yellow.

3 Touch [EXIT] to complete the setting.

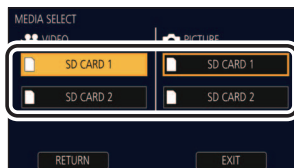

- In the following situation, if you start recording with normal settings or start recording when [2 SLOTS FUNC.] (→ 125) is set to [RELAY REC], the card slot used for motion picture recording will be switched automatically:*
 - An SD card is not inserted to the card slot selected in [MEDIA SELECT], or the SD card in the selected card slot is full when there is another SD card in the other slot.
- * The card slot is not switched when [2 SLOTS FUNC.] is set to [SIMULTANEOUS].
- You can also change the card slot used for motion picture recording by pressing the USER button to which <SLOT SEL> is registered or touching the applicable USER button icon while recording is paused. (→ 66)

Formatting media

If you use the SD cards for the first time for recording with this unit, format the cards. Please be aware that if a medium is formatted, then all the data recorded on the medium will be erased and cannot be restored. Back up important data on a PC etc. (→ 105)

- When using two SD cards, format both SD cards.

1 Select the menu.

 : [OTHER FUNCTION] → [FORMAT MEDIA]

2 Touch [SD CARD 1] or [SD CARD 2].

- When formatting is complete, touch [EXIT] to exit the message screen.
- Do not turn this unit off or remove the SD card, while formatting. Do not expose the unit to vibrations or shock.

Use this unit to format media.

Do not format an SD card using any other equipment such as a PC. Otherwise it may not be possible to use the card on this unit.



Recording motion picture

1 Set the mode switch to  to switch to Recording Mode.

(→ 28)

- Open the LCD monitor.

2 Press the recording start/stop button **A** to start recording.

- B** When you begin recording, REC (red) is displayed.
- Recording will stop when you press the recording start/stop button again.

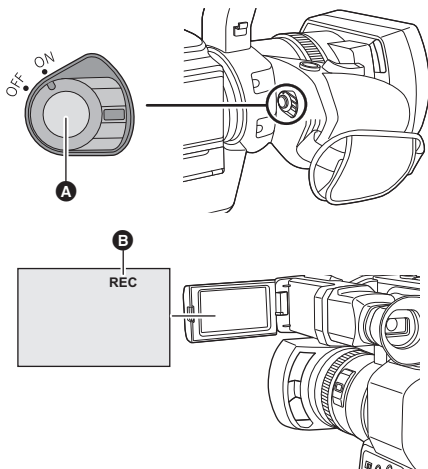

■ Screen indications in the Recording Mode



TC 00:00:00.00	Counter display (→ 63)
1 / 2 (White)	Card slot number
R 1h20m	Approximate remaining recordable time <ul style="list-style-type: none"> • When the remaining time is less than 1 minute, R 0h00m flashes red.
MAIN	Card slot selected for motion picture recording (→ 37)*
PH/080	Recording format (→ 118)
59.94i	Frame rate (→ 118)

* Displayed only during normal recording.

- To change the recording method, change [REC MODE] or [REC FORMAT]. (→ 117, 118)
- The images recorded between pressing the recording start/stop button to start recording and pressing it again to pause recording become one scene.

- When the file size of a recorded scene exceeds one of the following sizes or the recording time exceeds one of the following lengths of time, the scene will be divided automatically. (Recording continues.)

AVCHD scene	Approximately 4 GB
MOV/MP4 scene (when using an SDHC Memory Card)	Approximately 4 GB or 30 minutes
MOV/MP4 scene (when using an SDXC Memory Card)	Approximately 3 hours

- (Maximum recordable scenes of a single SD card)

Recording mode	MOV/MP4	AVCHD
Recordable scenes	Approx. 89100	Approx. 3900
Different dates (→ 95)	Approx. 900	Approx. 900

- When the SD card contains scenes recorded with [REC MODE] set to [MOV]/[MP4] and still pictures, the maximum recordable scenes and the maximum recordable scenes on each date will be smaller than those in the table above.
- Number of scenes that can be recorded will be less than above in following cases:
 - If you change [REC FORMAT] (→ 118)
 - When [2 SLOTS FUNC.] is set to [SIMULTANEOUS] (→ 125)
 - During the Interval Recording (→ 127)
- Please refer to page 155 about approximate recordable time.



Recording still pictures

- Register <CAPTURE> to a USER button. (→ 66)

1 Set the mode switch to to switch to Recording Mode. (→ 28)

- Open the LCD monitor.

2 Press the USER button to which <CAPTURE> is registered or touch the applicable USER button icon to record a still picture.

- For information on the locations of the USER buttons and information on USER button icons, refer to page 66.
- When still pictures are being recorded, the remaining recordable number of still pictures and the still picture indication are displayed.

■ About the screen indications while recording still pictures



	Size of still pictures
R3000	Remaining number of still pictures
	Still picture indication (→ 143)

■ About picture size

Picture sizes in which still pictures will be recorded differ depending on the [REC MODE] setting and the [REC FORMAT] setting (→ 117, 118).

Recording mode	Recording format	Aspect	Picture size
MOV, MP4	[REC FORMAT] setting with a size of FHD (1920×1080)	16:9	1920×1080
AVCHD	[PS 1080/59.94p], [PH 1080/59.94i], [PH 1080/23.98p], [HA 1080/59.94i], [HE 1080/59.94i], [PM 720/59.94p]		640×360
		[SA 480/59.94i]	4:3

- It is possible to record still pictures while recording motion pictures. (rec-and-capture)
- It is recommended to use a tripod when recording under low light conditions because the shutter speed becomes slow.
- If rec-and-capture is used while recording a motion picture, the remaining recordable time will shorten. If you turn off the unit or change the mode switch position, the remaining recordable time may increase.
- Maximum number of recordable pictures that can be displayed is 9999. If the number of recordable pictures exceeds 9999, R 9999+ is displayed. The number will not change when the picture is taken until the number of recordable pictures is 9999 or less.
- The 16:9 still pictures recorded using this unit may be cropped at the edges when printed. So, be sure to check before printing in the store or on your printer.
- Please refer to page 156 about approximate number of recordable pictures.
- The recording time may be long depending on the recording condition.



Intelligent Auto Mode/Manual Mode

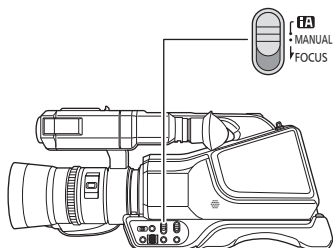

iA/MANUAL/FOCUS switch

Slide the switch to change the Intelligent Auto Mode/Manual Mode.

- When you slide the switch to FOCUS, the unit will switch between Auto Focus Mode and Manual Focus Mode. (→ 47)
- **iA** appears on the screen in Intelligent Auto Mode.

■ Intelligent Auto Mode

When switching to Intelligent Auto Mode, the Automatic Tracking White Balance and Auto Focus operate and automatically adjust the color balance and focusing. Depending on the brightness of the subject etc., the Iris, gain and shutter speed are automatically adjusted for an optimum brightness.

- Color balance and focus may not be adjusted automatically depending on light sources or scenes. If so, manually adjust these settings. (→ 47, 56)
- The following settings in Manual Mode are canceled when you switch to Intelligent Auto Mode:
 - Focus (→ 47)
 - Focus Assist (→ 49)
 - Iris (→ 53)
 - GAIN (→ 54)
 - White Balance (→ 56)
 - Shutter speed (→ 59)
 - [SCENE MODE] (→ 114)
- When you switch this unit from Manual Mode to Intelligent Auto Mode, Image Stabilizer will be set to / ([ON]). (→ 83)
- If you set the Image Stabilizer to (setting canceled) in Manual Mode and then switch to Intelligent Auto Mode, the Image Stabilizer setting that is selected when you switch to Manual Mode again will be determined by whether or not you touch the operation icon **O.I.S.** in Intelligent Auto Mode.*

* In the same way, the Image Stabilizer setting is also determined by whether or not you press the USER button to which <O.I.S.> is registered.

<p>When the operation icon O.I.S. is pressed or the USER button to which <O.I.S.> is registered is pressed</p>	<p>The Image Stabilizer setting in Intelligent Auto Mode will be applied.</p>
<p>When the operation icon O.I.S. is not pressed or the USER button to which <O.I.S.> is registered is not pressed</p>	<p>The Image Stabilizer will be set to (setting canceled).</p>

Automatic Tracking White Balance

The Auto Tracking White (ATW) Balance function of this unit automatically adjusts the White Balance according to the lighting condition.

If Auto Tracking White Balance does not work correctly, switch to Manual Mode first, and then adjust the White Balance. (→ 56)

Auto Focus

The unit focuses automatically.

- Auto Focus does not work correctly in the following situations. Record pictures in the Manual Focus Mode. (→ 47)
 - Recording distant and close-up objects at the same time
 - Recording a subject behind dirty or dusty window
 - Recording a subject that is surrounded by objects with glossy surfaces or by highly reflective objects

■ Camera controls that are disabled in Intelligent Auto Mode

The camera function button and the IRIS button are disabled in Intelligent Auto Mode.

■ USER buttons that are disabled in Intelligent Auto Mode

USER buttons 1 to 3 may be disabled in Intelligent Auto Mode, depending on the USER button functions registered to them. When any of the following USER button functions is registered, use it in Manual Mode:

- <FOCUS ASSIST 1>
- <FOCUS ASSIST 2>
- <SUPER GAIN>
- <AREA>
- <PUSH AF>
- <DRS>
- <FLASH BAND>
- <SUPER SLOW>



Using the zoom

It can be zoomed up to 20×.

- It can zoom up to approx. 40× when the [i.Zoom] is set to [ON]. (→ 125)
- Zoom magnification can be checked in the screen display of Z00 to Z99. The value gets larger when zoomed in, and the value gets smaller when zoomed out.
 - If you set [i.Zoom] to [ON], the magnification level will be displayed as follows:
 - iZ00 to iZ99: optical zoom range
 - **iZ99**: i.Zoom

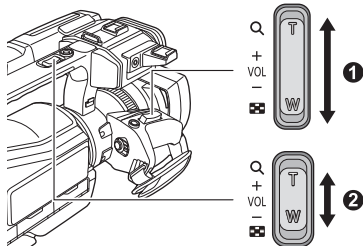

Zoom lever ①/Sub zoom lever ②

T side:

Close-up recording (zoom in)

W side:

Wide-angle recording (zoom out)

■ Zooming with the multi-manual ring

You can also perform zooming by rotating the multi-manual ring.

- You can also adjust focus and iris with the multi-manual ring. (→ 46)

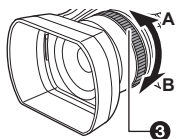

Multi-manual ring ③

A side:

Wide-angle recording (zoom out)

B side:

Close-up recording (zoom in)

■ About the zoom speed

- The zoom speed will vary depending on how far the zoom lever is pressed or how fast the multi-manual ring is rotated.
 - The zoom operation using the sub zoom lever will be performed at a constant speed. Zoom speed of the sub zoom lever will vary depending on the setting of [SUB ZOOM]. (→ 124)
-
- If you take your finger off the zoom lever during zoom operation, the operation sound may be recorded. When returning the zoom lever to the original position, move it quietly.
 - The sound of the zoom mechanism becomes louder than usual during fast zoom operation. This may cause the sound to be recorded during recording.
 - It can be focused approximately 1.5 m (4.9 feet) or further when the zoom magnification is at its maximum.
 - It can be focused approximately 3.0 cm (1.2 ") or further when the zoom magnification is set to 1×.

Utilizing the USER button

Digital zoom can be used by assigning <D.ZOOM> to a USER button. (→ 70)

- Please refer to page 66 for details about setting the USER button.



Using the Built-in LED Light

Even in dark locations, you can record brighter scenes by turning on the built-in LED light. Slide the LED LIGHT switch to turn on the built-in LED light.

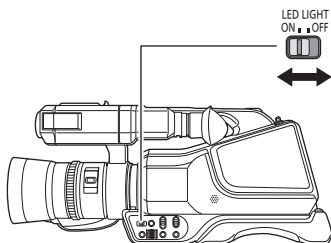

LED LIGHT switch

Slide the switch to turn on/off the built-in LED light.

ON: Turned on

OFF: Turned off

- Do not look at the light-emitting portion of the built-in LED light directly while the light is turned on, or bring the portion close to someone's eyes and turn on the light.
- The recordable time with the battery becomes shorter with the use of the built-in LED light.
- The White Balance mode [ATW] (Auto Tracking White Balance) may not work correctly while the built-in LED light is turned on, depending on recording conditions. In this case, switch to Manual Mode and adjust the White Balance. (→ 56)
- When the battery becomes low, the built-in LED light may not turn on.

■ Using the diffusion filter (supplied) of the built-in LED light

The supplied diffusion filter softens the light by reducing its glare. Use the diffusion filter when the built-in LED light is too bright.

Attaching/removing the filter for the built-in LED light

(How to attach/detach the filter)

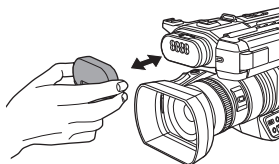

- Push in until a clicking sound is heard.
- Hold both the left and right sides of the filter to remove it.



Manual Recording

Zoom, focus, and iris can be adjusted by operating the multi-manual ring. Gain, White Balance and shutter speed can be adjusted by operating the manual icon and the jog dial.

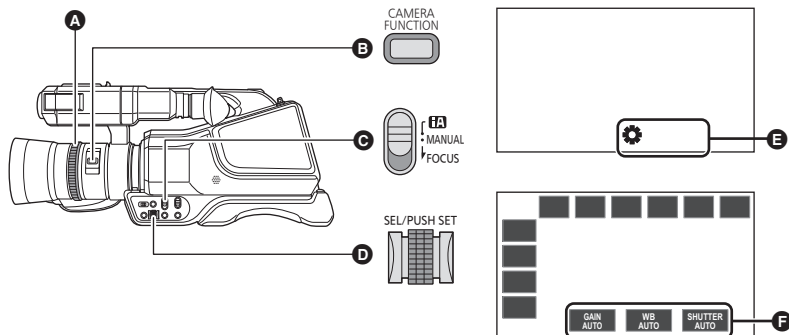



- A** Multi-manual ring
- B** Camera function button
- C** iA/MANUAL/FOCUS switch

- D** Jog dial
- E** Manual ring setting
[FOCUS], [ZOOM], [IRIS]
- F** Manual icon

1 Set the iA/MANUAL/FOCUS switch to MANUAL to switch to Manual Mode.

- Touch the manual icon to set the gain, White Balance and shutter speed.

-  Gain (→ 54)
-  White Balance (→ 56)
-  Shutter speed (→ 59)

2 (When adjusting focus and iris)

Slide the iA/MANUAL/FOCUS switch to the FOCUS position, or press the IRIS button.

- The iA/MANUAL/FOCUS switch will return to the MANUAL position.

3 (When adjusting focus and iris)

Press the camera function button to change the manual ring setting.

- Switches the setting each time the button is pressed.

[ FOCUS] → [ ZOOM] → [ IRIS]

4 Rotate the multi-manual ring to adjust.

- Refer to the following pages for details about focus and iris:
 - Focus (→ 47)
 - Iris (→ 53)



Focus

Use the multi-manual ring to adjust focus. If auto focusing is difficult due to the conditions, then use Manual Focus.

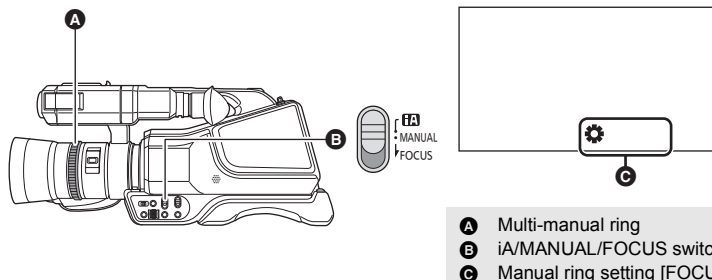

- A** Multi-manual ring
- B** iA/MANUAL/FOCUS switch
- C** Manual ring setting [FOCUS]

● Switch to Manual Mode. (→ 42)

1 Slide the iA/MANUAL/FOCUS switch to the FOCUS position.

- The iA/MANUAL/FOCUS switch will return to the MANUAL position.
- It will switch to MF from AF.
- The manual ring setting will change to [FOCUS].

2 Rotate the multi-manual ring to adjust the focus.

- The focus value can be set from MF00 (focus distance: approximately 3 cm (1.2")) to MF99 (focus distance: infinity). The larger the focus value gets, the further the position where focus is achieved.
- If you slide and hold the iA/MANUAL/FOCUS switch towards FOCUS, the focus will be adjusted to MF95 on the infinity side.
- To return to Auto Focus, perform one of the following operations:
 - Set the iA/MANUAL/FOCUS switch to FOCUS again.
 - Set the iA/MANUAL/FOCUS switch to iA to switch to Intelligent Auto Mode.

-
- When the distance to the subject approaches within 1.5 m (4.9 feet) approx., the unit switches to the macro range and [AF] or [MF]. (The unit may switch to the macro range even when the distance to the subject is 1.5 m (4.9 feet) or more depending on the subject.)
 - Depending on the zoom magnification, this unit may fail to switch to the macro range, or go to a non-displayed focus value.
 - When you perform a zoom operation in the macro range, this unit may go out of focus.
 - This item cannot be set during Freeze Frame. (→ 72)

■ To emphasize the outline of images

Setting [EVF/LCD DETAIL] to [ON] helps you achieve focus easier by emphasizing the outlines of an image displayed on the LCD monitor and viewfinder.

You can also adjust the emphasis level or change the frequency.

- You can also enable or disable this function with the applicable USER button. (→ 74)
- These settings will not affect the images actually recorded.

 : [DISP SETUP] → [EVF/LCD DETAIL] → [ON]

Adjusting the level of [EVF/LCD DETAIL]

1 Select the menu.

 : [DISP SETUP] → [EVF/LCD PEAK LEVEL]

2 Touch / to adjust settings.

- You can select a value between -3 and +3.

3 Touch [EXIT] to complete the setting.

Setting the peaking frequency of [EVF/LCD DETAIL]

Select the menu.

 : [DISP SETUP] → [EVF/LCD PEAK FREQ.] → [HIGH] or [LOW]

- [EVF/LCD DETAIL] is canceled in following cases:
 - When Focus Assist (peaking function) is used (→ 49)

One Push AF

If you press the USER button to which <PUSH AF> is registered in Manual Focus Mode, the camera performs high-speed focusing until the image is focused.

- This function is registered to the USER1 button by default.
- **Switch to Manual Focus Mode.** (→ 47)

Press the USER button to which <PUSH AF> is registered or touch the applicable USER button icon.

- Auto Focus will be activated and the camera will perform high-speed focusing until the image is focused.
- The focus setting returns to Manual Focus Mode once the image is focused or a certain time has elapsed.

- One Push AF does not work in following cases:
 - When Auto Focus is used

Push AF

If you press and hold the USER button to which <PUSH AF> is registered, Manual Focus will be temporarily switched to Auto Focus.

- This function is registered to the USER1 button by default.

• **Set this unit to Manual Focus.** (→ 47)

Press and hold the USER button to which <PUSH AF> is registered or touch and hold the applicable USER button icon.

- The focus position will be automatically adjusted for the subject at the center of the screen.
- If you set [AREA MODE] to [FOCUS], [FOCUS/IRIS] or [FOCUS/Y GET] and use Area Mode, the focus position will be automatically adjusted to the subject you have touched. (→ 73)
- It will be canceled when the button is released, and the focus position set by the Push AF will be maintained.

- Push AF does not work in following cases:

– When Auto Focus is used

Focus Assist

You can use Focus Assist by pressing the USER button to which <FOCUS ASSIST 1> or <FOCUS ASSIST 2> is registered.

- For information on how to set the USER buttons, refer to page 66.
- <FOCUS ASSIST 1> is registered to the USER3 button by default.

Selecting a Focus Assist method

■ To select the Focus Assist method for the USER button to which <FOCUS ASSIST 1> is registered

Select the menu.

 : [SW SETUP] → [FOCUS ASSIST 1] → desired setting

[EXPAND]: Magnifies the central area of the screen when Focus Assist is used.

[PEAKING]: Highlights in-focus portions with color when Focus Assist is used.

[BOTH]: Sets both [EXPAND] and [PEAKING].

■ To select the Focus Assist method for the USER button to which <FOCUS ASSIST 2> is registered

Select the menu.

 : [SW SETUP] → [FOCUS ASSIST 2] → desired setting

[EXPAND] / [PEAKING]

- You can use the magnified display and the peaking function separately or use them in combination by selecting different settings for [FOCUS ASSIST 1] and [FOCUS ASSIST 2].
- If [FOCUS ASSIST 1] is set to [BOTH], [FOCUS ASSIST 2] is not available. In addition, the USER button to which <FOCUS ASSIST 2> is registered is disabled.

Using Focus Assist

- Register <FOCUS ASSIST 1> or <FOCUS ASSIST 2> to a USER button. (→ 66)
- Switch to Manual Focus Mode. (→ 47)

Press the USER button to which <FOCUS ASSIST 1> or <FOCUS ASSIST 2> is registered or touch the applicable USER button icon.

- To cancel, perform one of the following operations:
 - Press the USER button again, or touch the USER button icon again.
 - Touch [EXIT].

■ To adjust the magnified display

If you set Focus Assist to ON by following either of the procedures below, the central area of the screen will be magnified. You can change the magnification and position of the magnified display.

- Setting the menu item [FOCUS ASSIST 1] to [EXPAND] or [BOTH] and pressing the USER button to which <FOCUS ASSIST 1> is registered.
 - Setting the menu item [FOCUS ASSIST 2] to [EXPAND] and pressing the USER button to which <FOCUS ASSIST 2> is registered.
- You can also change the magnification level of the magnified display using the jog dial.

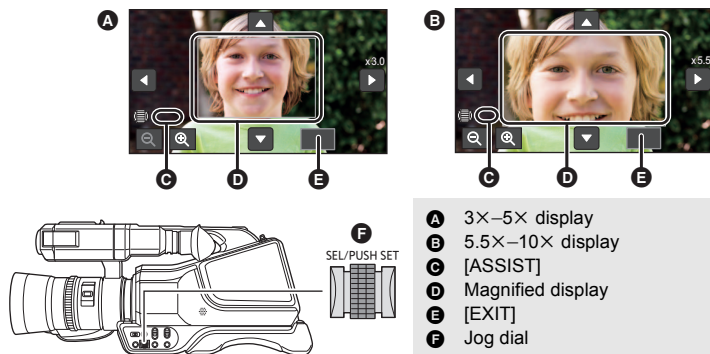

(To change the magnification level)

Touch / or rotate the jog dial to change the magnification level.



: Increases the magnification level by 0.5×.

: Decreases the magnification level by 0.5×.

- You can adjust the magnification from 3× to 10×.

(Moving the magnified area)

Touch / / / or slide the screen while touching it to move the magnified area.

■ To change the peaking settings

If you set Focus Assist to ON by following either of the procedures below, in-focus portions are highlighted with color (Peaking ) .



- Setting the menu item [FOCUS ASSIST 1] to [PEAKING] or [BOTH] and pressing the USER button to which <FOCUS ASSIST 1> is registered.
 - Setting the menu item [FOCUS ASSIST 2] to [PEAKING] and pressing the USER button to which <FOCUS ASSIST 2> is registered.
- You can set the peaking color and strength.

(When changing the peaking color)

Select the menu.

 : [SW SETUP] → [PEAKING COLOR] → desired color

[Red]/[Blue]/[Yellow]/[White]

(When setting the peaking strength)

1 Select the menu.

 : [SW SETUP] → [PEAKING LEVEL] → desired setting

2 Touch / to adjust settings.

- You can select a value between -7 and +7.

3 Touch [EXIT] to complete the setting.

(Notes on Focus Assist)

- Focus Assist is not possible in following cases:
 - During Recording Check (→ 71)
 - During Freeze Frame (→ 72)
 - When color bars are displayed. (→ 83)
- Focus Assist is canceled in following cases:
 - If you turn the unit off
 - When the mode switch position is changed
 - (If you operate the USER button to which <FOCUS ASSIST 1> is registered)
When the setting of [FOCUS ASSIST 1] (→ 50) is changed
 - (If you operate the USER button to which <FOCUS ASSIST 2> is registered)
When the setting of [FOCUS ASSIST 2] (→ 50) is changed
 - When you set this unit to Auto Focus
- The magnified display and peaking are not displayed on recorded images.
- The magnified display and peaking are not displayed on a TV.
- Freeze Frame is not available when you use Focus Assist. (→ 72)
- Peaking may not be displayed when you use Digital Zoom (→ 70). To zoom in and use peaking at the same time, we recommend increasing the magnification level of the magnified display by setting [FOCUS ASSIST 1] to [BOTH] or by using the magnified display and the peaking function in combination.

(Notes on the magnified display of Focus Assist)

- Some information on the screen disappears when the screen is magnified.
- Still pictures cannot be recorded when the screen is magnified.
- In the following cases, the screen is not magnified during Focus Assist:
 - During motion picture recording or PRE-REC (→ 77, 128)
 - When using Digital Zoom
 - When using Area Mode (→ 73)
 - During auto recording (→ 80)
 - During Super Slow Recording (→ 78)
- If you set the magnification level of the magnified display to 5.5× or higher, peaking may not be displayed when using i.Zoom (→ 44).



Iris/Gain adjustment

When recording a scene that is too dark (or bright) or a scene in a similar situation, manually adjust the iris and gain.

Iris adjustment

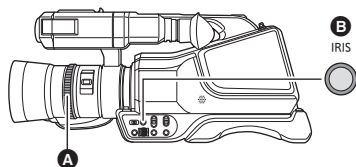

- A** Multi-manual ring
 - B** IRIS button
 - C** Manual ring setting [IRIS]
 - D** Auto iris icon*
 - E** Iris value
- * It is displayed in Auto Iris Mode.

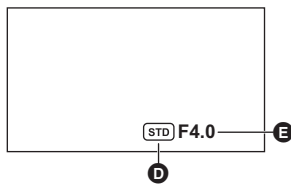
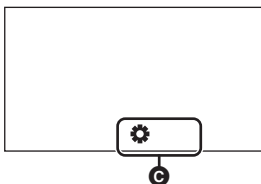

- Switch to Manual Mode. (→ 42)

1 Press the IRIS button to switch to Manual Iris Mode.

- [STD] disappears.
- The manual ring setting will change to [⚙️ IRIS].

2 Rotate the multi-manual ring to adjust the setting.

Iris value:

CLOSE ↔ (F11 to F1.9) ↔ **OPEN**

- Value closer to CLOSE darkens the image.
- Value closer to OPEN brightens the image.
- To return to Auto Iris Mode, perform one of the following operations:
 - Press the IRIS button.
 - Set the iA/MANUAL/FOCUS switch to iA to switch to Intelligent Auto Mode.



-
- It is not possible to adjust the iris in the following situations:
 - When a setting in [SCENE MODE] is enabled (→ 114)
 - During Freeze Frame (→ 72)
 - Depending on the zoom magnification, there are iris values that are not displayed.
 - In Auto Gain Mode or Auto Shutter Mode, the screen brightness may not change even if you adjust the iris. (→ 54, 59)

■ To enable Backlight Compensation

If you enable [BACKLIGHT COMPENS.] in Auto Iris Mode, automatic iris control will be activated for backlight compensation, brightening the screen image by preventing subjects from appearing dark when there is a light source behind them.

Select the menu. (→ 36)

MENU : [CAMERA SETUP] → [BACKLIGHT COMPENS.] → [ON]

-  appears when it is set.
 - It will return to standard Auto Iris Mode () when it is canceled. (→ 53)
-
- You can also change the setting using the USER button to which <BACKLIGHT> is registered (→ 69)
 - This function is not available in the following cases:
 - When [SCENE MODE] is set to [Fireworks] (→ 114)
 - During Freeze Frame (→ 72)
 - Backlight Compensation is canceled when you turn off this unit.

Gain adjustment

- Use the jog dial to change the settings.

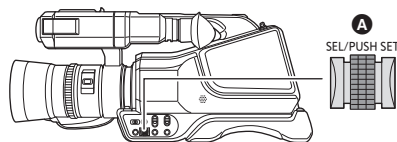

- A** Jog dial
- B** Gain value
 - In Auto Gain Mode, "AGC" is displayed; in Manual Gain Mode, the gain value is displayed in dB.
- C** [GAIN]

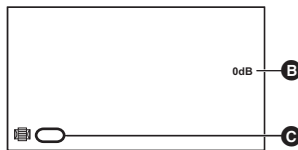
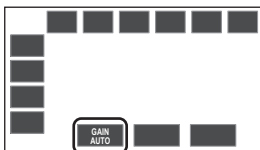

- Switch to Manual Mode. (→ 42)

1 Touch the LCD monitor in the recording screen.

- Operation icons are displayed.

2 Touch  to switch to Manual Gain Mode.

- The gain value will be displayed in dB.

3 Adjust the gain by rotating the jog dial.

Gain value:

0dB to 30dB

- Value closer to 0dB darken the image.
- Value closer to 30dB brighten the image.



- To return to Auto Gain Mode, perform one of the following operations:
 - Touch .
 - Set the iA/MANUAL/FOCUS switch to iA to switch to Intelligent Auto Mode.

-
- It is not possible to adjust the [GAIN] in the following situations:
 - When a setting in [SCENE MODE] is enabled (→ 114)
 - During Freeze Frame (→ 72)
 - If the gain value is increased, the noise on the screen increases.
 - In Auto Iris Mode or Auto Shutter Mode, the screen brightness may not change even if you adjust the gain. (→ 53, 59)

■ Changing the maximum possible gain value for Auto Gain Mode

- Switch to Manual Mode. (→ 42)

Select the menu.

 : [SW SETUP] → [AGC LIMIT] → desired setting

[3 dB]/[6 dB]/[9 dB]/[12 dB]/[15 dB]/[18 dB]/[21 dB]/[24 dB]/[27 dB]/[30 dB]

-
- [AGC LIMIT] is not available when a setting in [SCENE MODE] is enabled. (→ 114)

Super Gain

You can use Super Gain by registering <SUPER GAIN> to a USER button.

Super Gain allows you to set the gain value to 33 dB or 36 dB.

- Please refer to page 66 for details about setting the USER button.

- Switch to Manual Mode. (→ 42)

Press the USER button to which <SUPER GAIN> is registered or touch the applicable USER button icon.

- To cancel Super gain, press the USER button or touch the USER button icon again.

■ To change the gain value of Super Gain

Select the menu.

 : [SW SETUP] → [SUPER GAIN] → desired setting

[33 dB]/[36 dB]

-
- Super Gain is not available in the following cases:
 - In Intelligent Auto Mode
 - When a setting in [SCENE MODE] is enabled (→ 114)
 - During Freeze Frame (→ 72)
 - Super Gain will be canceled when the unit is turned off.



White Balance

Automatic White Balance function may not reproduce natural colors depending on the scenes or lighting conditions. If so, you can adjust the White Balance manually.

- Use the jog dial to change the settings.

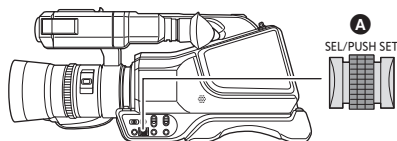

- A** Jog dial
- B** [WB]
- C** Color temperature display
- Displayed when the White Balance mode is set to VAR.
- D** White Balance

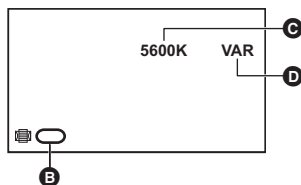
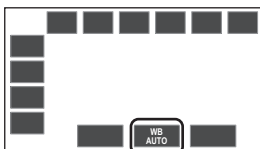

- **Switch to Manual Mode. (→ 42)**

1 Touch the LCD monitor in the recording screen.

- Operation icons are displayed.

2 Touch **WB AUTO** to switch to Manual White Balance Mode.

- The previously used White Balance mode will be selected.
- Each time you touch the icon, the White Balance mode is switched between Auto Tracking White (ATW) Balance Mode and Manual White Balance Mode (P3200K/P5600K/VAR/Ach/Bch).

3 Rotate the Jog dial to switch the White Balance mode.

- The mode will be switched in the following order:

P3200K ↔ P5600K ↔ VAR ↔ Ach ↔ Bch



About White Balance modes

Display (mode)	Settings
ATW (Auto Tracking White Balance)	It will automatically adjust in accordance with the recording condition.
LOCK (ATW Lock)	It will lock the setting for ATW.
P3200K (P3200K)	Preset value for studio/indoor recording (halogen lamp, etc.)
P5600K (P5600K)	Preset value for outdoors
VAR (VAR)	Setting can be finely adjusted in accordance to the recording conditions. (→ 58)
Ach (Ach)	Setting in accordance to the recording scenes can be set. (→ 58)
Bch (Bch)	Setting in accordance to the recording scenes can be set. (→ 58)

- To return to ATW (Auto Tracking White Balance), perform one of the following operations:
 - Touch .
 - Press the USER button assigned as <WHITE BAL>.
 - Set the iA/MANUAL/FOCUS switch to iA to switch to Intelligent Auto Mode.
-
- You can perform the same operation as step 2 with the USER button assigned as <WHITE BAL>. This function is registered to the USER2 button by default.
 - It is not possible to change the white balance mode in the following situations:
 - When [SCENE MODE] is set to [Beach]/[Sunset]/[Fireworks] (→ 114)
 - During Freeze Frame (→ 72)

To set ATW Lock

You can set ATW Lock by registering <ATW LOCK> to a USER button.

- Please refer to page 66 for details about setting the USER button.
- 1 Set the White Balance mode to [ATW]. (→ 56)**
 - Touch the operation icon  when using a mode other than [ATW].
 - 2 Press the USER button to which <ATW LOCK> is registered or touch the applicable USER button icon to switch to [LOCK].**
 - To cancel ATW Lock, press the USER button or touch the USER button icon again. Canceling ATW Lock will return the White Balance mode back to [ATW].
-
- ATW Lock is not available except when the White Balance mode is set to [ATW].
 - It will be canceled when the unit is turned off.

To finely adjust the White Balance

Setting the White Balance mode to [VAR] allows you to set a White Balance value between 2000K and 15000K.

- Use the jog dial to change the settings.

- **Switch to Manual Mode.** (→ 42)

1 Set the White Balance mode to [VAR]. (→ 56)

2 Push the jog dial.



3 Rotate the jog dial to adjust the color balance.



4 Push the jog dial to finish the adjustment.

- The set value is not guaranteed to be an exact value. Use it only as a guide.



To set the White Balance in accordance to the recording scene

1 Fill the screen with a white subject or place a white piece of paper in front of the lens.

2 Set the White Balance mode to [Ach] or [Bch]. (→ 56)

3 Touch and hold  or press and hold the jog dial to perform Auto White Balance adjustment.

- Adjust the Black Balance first, and then the White Balance. The screen goes dark momentarily, "WB SET OK" is displayed, and the adjustment ends.

- If the White Balance mode is set to anything other than [Ach] or [Bch], Auto Black Balance adjustment is performed when you touch and hold  or  or press and hold the jog dial during recording pause. Adjustment is complete when the screen blacks out momentarily and [BB SET OK] is displayed*.

* When the White Balance mode is set to [ATW] (Auto Tracking White Balance), touch and hold  to perform Auto Black Balance adjustment.

- You can also perform Auto White Balance or Auto Black Balance adjustment by pressing and holding the USER button assigned as <WHITE BAL>.

- When the Auto White Balance/Auto Black Balance cannot be performed, an error message "WB SET NG" or "BB SET NG" is displayed on the screen. In such case, use other mode.

- Settings assigned to [Ach] or [Bch] can be finely adjusted in [AWB Ach ADJUST]/[AWB Bch ADJUST]. (→ 116)

- The contents previously set are maintained in the [Ach] or [Bch]. Perform the setting again when the recording condition has changed.



Manual shutter speed

Adjust the shutter speed when recording fast-moving subjects.

- Use the jog dial to change the settings.

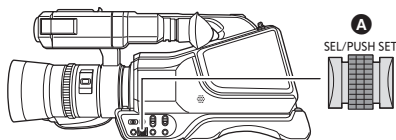

- A** Jog dial
- B** [SHUTTER]
- C** Auto Shutter display
 - This is displayed in Auto Shutter Mode.
- D** Shutter speed

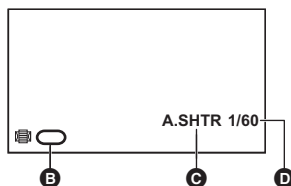
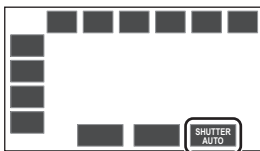

- Switch to Manual Mode. (→ 42)

1 Touch the LCD monitor in the recording screen.

- Operation icons are displayed.

2 Touch **SHUTTER AUTO** to switch to Manual Shutter Mode.

3 Adjust the shutter speed by rotating the jog dial.

- To return to Auto Shutter Mode, perform one of the following operations:

- Touch **SHUTTER MANUAL**.
- Set the iA/MANUAL/FOCUS switch to iA to switch to Intelligent Auto Mode.



Shutter speed:

The shutter speed varies depending on the frame rate in [REC FORMAT]. (→ 118)

Frame rates	Shutter speed
59.94p/59.94i	1/8 ↔ 1/15 ↔ 1/30 ↔ 1/60 ↔ 1/100 ↔ 1/120 ↔ ... 1/8000
29.97p	1/8 ↔ 1/15 ↔ 1/30 ↔ 1/50 ↔ 1/60 ↔ 1/100 ↔ ... 1/8000
23.98p	1/6 ↔ 1/12 ↔ 1/24 ↔ 1/48 ↔ 1/50 ↔ 1/60 ↔ ... 1/8000

- The shutter speed closer to 1/8000 is faster.

-
- The shutter speed cannot be adjusted in the following cases:
 - When a setting in [SCENE MODE] is enabled (→ 114)
 - During Freeze Frame (→ 72)
 - You may see a band of light around an object that is shining very bright, or highly reflective.
 - During normal playback, image movement may not look smooth.
 - If you record an extremely bright object or record under indoor lighting, color and screen brightness may change or a horizontal line may appear on the screen. In such cases, change settings as follows:
 - Set this unit to Auto Shutter Mode.
 - Adjust the shutter speed to 1/50, 1/60 or 1/100.
 - In Auto Iris Mode or Auto Gain Mode, the screen brightness may not change even if you adjust the shutter speed. (→ 53, 54)
 - When the shutter speed setting is slow, this unit may not be able to keep up with changes in the image. In such a case, set the iris, focus, and White Balance mode to manual settings.



Audio Input

This unit can record audio in 2 ch.

■ About audio recording methods

The audio recording method varies depending on the [REC MODE] setting. (→ 117)

Recording mode	Audio recording method
MOV	Linear PCM (LPCM)
MP4	
AVCHD	Dolby Audio

Adjusting the audio input level

Selecting an adjustment method

1 Select the menu.

: [AUDIO SETUP] → [AUDIO LEVEL] → desired setting

[AUTO]: Adjusts the level automatically.

[MANUAL]: Adjusts the level manually.

2 (When [MANUAL] has been selected) Confirm that the jog dial icon [MIC VOLUME] (A (yellow display: Function Selection Mode) is displayed, and press the jog dial button.

- Touch the screen if operation icons are displayed.
- The jog dial icon turns white. (Function Execution Mode)



3 Rotate the jog dial to adjust the input level.

- After adjusting, press the jog dial. The jog dial icon turns yellow.
- You can also adjust the volume by touching / . If you leave the unit idle after adjustment, it will exit the setting mode.

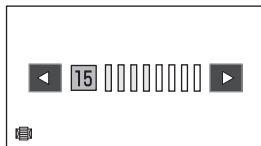

Using the ALC function

ALC can reduce audio noise.

1 Set [AUDIO LEVEL] to [MANUAL]. (→ 61)

2 Select the menu.

 : [AUDIO SETUP] → [AUDIO ALC] → **desired setting**

[ON]: Enables ALC, allowing you to record audio with reduced noise.

[OFF]: Allows you to record natural-sounding audio.

Counter display

You can change a counter display that indicates how much time has elapsed during recording or playback.

1 Touch the LCD monitor while the recording screen is displayed.

- Operation icons will be displayed.

2 Touch **COUNT** to switch the counter display.

- The display will be switched in the following order:
Time Code → Recording Counter → Off

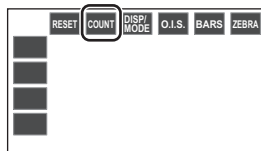

Counter display	Indications
Time Code	TC 00:00:00:00 or TC 00:00:00.00 <ul style="list-style-type: none"> • Display will change depending on the setting of the [DF MODE]. (→ 64)
Recording Counter (→ 65)	(In Recording Mode) 0:00:00 or SCN 0:00:00 (In Playback Mode) SCN 0:00:00 <ul style="list-style-type: none"> • In Recording Mode, display will change depending on the setting of the [REC COUNTER]. • In Playback Mode, display will return to SCN 0:00:00 for each scene.

Setting the Time Code

Time code will display the recording time in hours, minutes, seconds, and frames.

TC 00:00:00:00 (hour : minute : second : frame [NDF])

TC 00:00:00.00 (hour : minute : second . frame [DF])

- The number of frames (frame count per second) varies depending on the frame rate in [REC FORMAT]. (→ 118)

Frame rates	Frame
59.94p/59.94i/29.97p	0 to 29
23.98p	0 to 23

[DF MODE]



Select the compensation mode for the time code.

Select the menu.

: [RECORD SETUP] → [DF MODE] → **desired setting**

[DF]: Time code is compensated in accordance with the actual time. It is mainly used for broadcasting such as TV programs.

[NDF]: It will not compensate the time code. (There will be a difference from the actual time)

- This item will be set to [NDF] automatically in following cases:
 - When the frame rate in [REC FORMAT] is 23.98p (→ 118)
 - During the Interval Recording (→ 127)

[TCG]



Sets the way the time code will move.

Select the menu.

: [RECORD SETUP] → [TCG] → **desired setting**

[FREE RUN]*: It will constantly move.

[REC RUN]: It will move only when recording.

- * If the frame rate in [REC FORMAT] is set to 23.98p, a slight time error may occur when switching to Playback Mode. (→ 118)
- [FREE RUN] is automatically selected during PRE-REC. (→ 77, 128)
- It is automatically set to [REC RUN] in following cases:
 - During Super Slow Recording (→ 78)
 - During the Interval Recording (→ 127)

- The time code will reset when the built-in lithium battery is exhausted when it is set to [FREE RUN].

[TC PRESET]



You can set the initial time code.

1 Select the menu.

: [RECORD SETUP] → [TC PRESET]

2 Touch the item to set and change with / .

- It will be set to 00h00m00s00f when the [Reset] is touched.
- “h” is an abbreviation for hour, “m” for minute, “s” for second and “f” for frame.

3 Touch [EXIT] to complete the setting.

- This unit will adjust the time code in accordance with the frame rate of the [REC FORMAT] (→ 118). Therefore, it may not be continuous from the previous final time code when the recording format is changed.
- If the frame rate in [REC FORMAT] is set to 23.98p, set the number of frames to [00] or a multiple of 4. If you enter a different value, time code will not be recorded correctly.

Setting the Recording Counter

Recording Counter will display the recording time in seconds.

0:00:00 (hour : minute : second (When [REC COUNTER] is set to [TOTAL]))

SCN 0:00:00 (hour : minute : second (When [REC COUNTER] is set to [SCENE]))

[REC COUNTER]



Select the counting method during the recording.

Select the menu.

 : [DISP SETUP] → [REC COUNTER] → desired setting

[TOTAL]:	The count continues to increase until the Recording Counter is reset.
[SCENE]:	Resets the Recording Counter at start of recording. Counts the time of each recording session.

To reset the Recording Counter for the Recording Mode

The Recording Counter will be set to 0:00:00 when  is touched while displaying the counter.

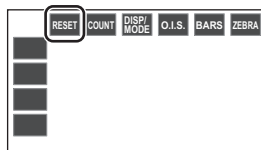

USER button

Each of the USER button can register one function from the 30 available functions.

- There are 3 USER buttons (USER1 to 3) on the main body and 4 USER button icons (USER4 to USER7) displayed on the LCD monitor.



Setting the USER button

1 Select the menu.

 : [USER SW] → [USER1] to [USER7]

- It is not possible to register functions to [USER4] to [USER7] in Playback Mode.

2 Touch the item to register.

- For the functions of the USER button that can be registered, refer to page 67.
- Touch <INHIBIT> if not registering.
- Next (Previous) page can be displayed by touching  / .

3 Touch [EXIT] to complete the setting.

- The tables below show the default settings.

USER1	<PUSH AF>
USER2	<WHITE BAL>
USER3	<FOCUS ASSIST 1>
USER4	<FRZ FRAME>

USER5	<DRS>
USER6	<LEVEL GAUGE>
USER7	<MENU>

- Performing [YES] in [INITIAL SET] restores these default settings. (→ 138)

Using the USER button

To use the function assigned to a USER button or USER button icon, press the applicable USER button (one of the USER buttons 1 to 3), or touch the applicable USER button icon (one of the USER button icons 4 to 7) while operation icons are displayed.

(When you use the USER1 to USER2 button)

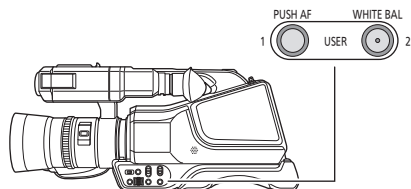

(When you use the USER3 button)

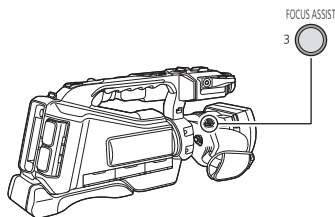

(When using button icons USER4 to USER7)

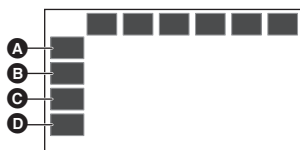

- A [USER4]
- B [USER5]
- C [USER6]
- D [USER7]

- To cancel, press the USER button or touch the USER button icon again.
For canceling or using of the following functions for the USER buttons, refer to each page.
 - <BLACK FADE> (→ 69)
 - <WHITE FADE> (→ 69)
 - <D.ZOOM> (→ 70)
 - <REC CHECK> (→ 71)
 - <LAST SCN DEL> (→ 71)
 - <AREA> (→ 73)
 - <AUTO REC> (→ 80)
 - <LCD/EVF OUTPUT> (→ 29)
 - <PUSH AF> (→ 48)
 - <PICTURE TONE> (→ 80)
 - <WHITE BAL> (→ 57, 58)

■ Switch display/not-display of the USER buttons

Display/not-display of the USER button icons in the LCD monitor can be switched.

Select the menu.

MENU  : [USER SW] → [USER BUTTON DISPLAY] → [ON] or [OFF]

■ Check the setting of the USER buttons

To check the USER button (USER1 to 3) settings on the recording screen, touch and hold the  to display the mode information screen. (→ 82)

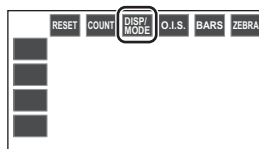

Functions of the USER button

■ List of USER button functions

Item	Icon	Function
<INHIBIT>	[INH]	Invalid
<FOCUS ASSIST 1>	[FA1]	Focus Assist 1*
<FOCUS ASSIST 2>	[FA2]	Focus Assist 2*
<BACKLIGHT>	[B.Light]	Backlight Compensation
<BLACK FADE>	[B.FD]	Black Fade
<WHITE FADE>	[W.FD]	White Fade
<SLOT SEL>	[SlotSel]	Slot Selection

Item	Icon	Function
<ATW LOCK>	[ATW.L]	ATW Lock
<D.ZOOM>	[D.ZM]	Digital Zoom
<HISTOGRAM>	[HIST]	Histogram
<REC CHECK>	[REC.C]	Recording Check
<LAST SCN DEL>	[LstDel]	Last Scene Delete
<DRS>	[DRS]	DRS*
<FRZ FRAME>	[FRZ]	Freeze Frame
<SUPER GAIN>	[S.Gain]	Super Gain*
<AREA>	[AREA]	Area Mode*
<PUSH AF>	[PushAF]	Push AF*
<CAPTURE>	[Capture]	Capture
<EVF/LCD DETAIL>	[DETAIL]	EVF/LCD detail
<LCD/EVF OUTPUT>	[LCD/EVF]	LCD/EVF Output
<LEVEL GAUGE>	[Level]	Level Gauge
<LEVEL SHOT>	[LevelShot]	Level Shot Function
<FLASH BAND>	[FBC]	Flash band compensation*
<PRE-REC>	[PRE-REC]	PRE-REC
<SUPER SLOW>	[SuperSlow]	Super Slow Recording*
<AUTO REC>	[AutoRec]	Auto Rec
<O.I.S.>	[O.I.S.]	Optical Image Stabilizer
<ZEBRA>	[ZEBRA]	Zebra
<PICTURE TONE>	[P.TONE]	Picture Tone
<WHITE BAL>	[WB]	White Balance
<MENU>	[MENU]	Menu

* These functions are not available in Intelligent Auto Mode.

- The following USER button function can also be set from the menu.
 - [BACKLIGHT COMPENS.] (→ 54)
 - [HISTOGRAM] (→ 133)
 - [DRS] (→ 116)
 - [LEVEL GAUGE] (→ 133)
 - [LEVEL SHOT] (→ 117)
 - [EVF/LCD DETAIL] (→ 48)
 - [FLASH BAND COMPENSATION] (→ 117)
 - [PRE-REC] (→ 128)
 - [LCD/EVF OUTPUT] (→ 29)
 - [SUPER SLOW REC] (→ 128)
 - [PICTURE TONE] (→ 114)

<FOCUS ASSIST 1>



- Register <FOCUS ASSIST 1> to a USER button. (→ 66)

You can set the Focus Assist. (→ 49)

- You can set the Focus Assist method in [FOCUS ASSIST 1] in the [SW SETUP] menu.

<FOCUS ASSIST 2>



- **Register <FOCUS ASSIST 2> to a USER button. (→ 66)**

You can set the Focus Assist. (→ 49)

- You can set the Focus Assist method in [FOCUS ASSIST 2] in the [SW SETUP] menu.
-

- When [FOCUS ASSIST 1] in the [SW SETUP] menu is set to [BOTH], the USER button is disabled.

<BACKLIGHT>



- **Register <BACKLIGHT> to a USER button. (→ 66)**

Switches to automatic iris control to compensate the backlight.

This makes the image brighter to prevent darkening of a backlit subject. (→ 54)

<BLACK FADE>



- **Register <BLACK FADE> to a USER button. (→ 66)**

Fade in/fade out effect (black) can be added to the video and audio that is being recorded.

Press USER button or touch USER button icon in the recording screen.

- Fade out will start, and fade in will start after completing the fade out.
 - It will fade out when the button is pressed and held, and fade in will start when the button is released.
-

- Recording will not start even if the fade out is started. It is possible to press the recording start/stop button during the fade in or fade out.

- Black Fade is not possible in following cases:

- During Super Slow Recording (→ 78)
- During the Interval Recording (→ 127)
- During Freeze Frame (→ 72)

- The thumbnails of scenes recorded using fade in become black.

<WHITE FADE>



- **Register <WHITE FADE> to a USER button. (→ 66)**

Fade in/fade out effect (white) can be added to the video and audio that is being recorded.

Press USER button or touch USER button icon in the recording screen.

- Fade out will start, and fade in will start after completing the fade out.
 - It will fade out when the button is pressed and held, and fade in will start when the button is released.
-

- Recording will not start even if the fade out is started. It is possible to press the recording start/stop button during the fade in or fade out.

- White Fade is not possible in following cases:

- During Super Slow Recording (→ 78)
- During the Interval Recording (→ 127)
- During Freeze Frame (→ 72)

- The thumbnails of scenes recorded using fade in become white.

<SLOT SEL>



- Register <SLOT SEL> to a USER button. (→ 66)

You can change the card slot used for motion picture recording or the playback media.

- You can change the setting in the following situations:
 - While recording is paused in Recording Mode
 - While a thumbnail screen is displayed in Playback Mode (→ 88)
 - While the list by date is selected (→ 95)

<ATW LOCK>



- Register <ATW LOCK> to a USER button. (→ 66)

This sets the White Balance mode to [ATW LOCK]. (→ 57)

<D.ZOOM>



- Register <D.ZOOM> to a USER button. (→ 66)

Press USER button or touch USER button icon in the recording screen.

- When [DIGITAL ZOOM] is set to [×2], [×5] or [×10], Digital Zoom will be turned on/off each time you press the button.
- When [DIGITAL ZOOM] is set to [TOGGLE], the zoom magnification will change each time you press the button.
2× → 5× → 10× → Setting canceled

■ To change the zoom magnification of Digital Zoom

The zoom magnification of Digital Zoom varies depending on the [DIGITAL ZOOM] setting.



: [SW SETUP] → [DIGITAL ZOOM] → desired setting

[×2]:	Sets the zoom magnification to 2×.
[×5]:	Sets the zoom magnification to 5×.
[×10]:	Sets the zoom magnification to 10×.
[TOGGLE]:	Changes the zoom magnification each time you press the applicable USER button.

- When using Digital Zoom, the larger you set the zoom magnification, the lower the picture quality becomes.
- Digital Zoom is not possible in following cases:
 - During Freeze Frame (→ 72)
 - When using Area Mode (→ 73)
 - During Super Slow Recording (→ 78)
 - During the Interval Recording (→ 127)
- Digital zoom is canceled in following cases:
 - If you turn the unit off
 - When the mode switch position is changed

<HISTOGRAM>



- Register <HISTOGRAM> to a USER button. (→ 66)

A graph with brightness as horizontal axis and number of pixels at that brightness as vertical axis is displayed. It is possible to determine the exposure of the whole image by looking at the distribution in the graph.

■ To move a histogram

You can move a histogram by touching and holding the histogram display **A**. Slide the display while touching it to move it to the desired display location.

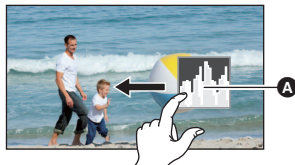

- This item cannot be set during Freeze Frame. (→ 72)
- To adjust the brightness, refer to page 53.

<REC CHECK>



- Register <REC CHECK> to a USER button. (→ 66)

Approximately 2 seconds at the end of the video recorded last can be played back. It will return to recording screen once the playback is completed.

- Playback operation is not possible during the Recording Check.
- Recording Check is not possible in following cases:
 - When the unit is turned on/off
 - When the mode switch position is changed
 - When the SD card is inserted/removed
 - When the setting of [REC FORMAT] is changed (→ 118)
 - Set [2 SLOTS FUNC.] to [SIMULTANEOUS]. (→ 125)
 - PRE-REC is used (→ 77, 128)
 - During the Interval Recording (→ 127)
 - During Freeze Frame (→ 72)

<LAST SCN DEL>



- Register <LAST SCN DEL> to a USER button. (→ 66)

The motion picture recorded last can be deleted.

Deleted scenes cannot be restored.

- 1 Press USER button or touch USER button icon in the recording screen.
- 2 Touch [YES].

- It will return to recording screen without deleting by touching [NO].

- Last Scene Delete is not possible in following cases:
 - When the unit is turned on/off
 - When the mode switch position is changed
 - When the SD card is inserted/removed
 - When the setting of [REC FORMAT] is changed (→ 118)
 - Set [2 SLOTS FUNC.] to [SIMULTANEOUS]. (→ 125)
 - During the Interval Recording (→ 127)

<DRS>



- Register <DRS> to a USER button. (→ 66)
- Switch to Manual Mode. (→ 42)

Selects the DRS (Dynamic Range Stretcher) function.

It is possible to expand the dynamic range by compressing the video signal level of the highly illuminated area that gets washed out with standard recording.

-
- This item cannot be set during Super Slow Recording. (→ 78)
 - If there are extremely dark or bright parts or the brightness is insufficient, the effect may not be clear.

<FRZ FRAME>



- Register <FRZ FRAME> to a USER button. (→ 66)

Freezes the image on the unit.

- Freeze will appear on the screen and flash.

-
- If you record a motion picture during Freeze Frame, the frozen image and sounds will be recorded.
 - You can perform the following camera operations during Freeze Frame. Other camera operations will be disabled.
 - Recording motion pictures
 - Canceling Freeze Frame
 - This function is not available in the following cases:
 - When using Focus Assist (→ 49)
 - During Super Slow Recording (→ 78)
 - During the Interval Recording (→ 127)
 - When color bars are displayed. (→ 83)
 - Freeze Frame is canceled in the following cases:
 - Turning off the unit
 - When the mode switch position is changed
 - This function is disabled during Super Slow Recording. (→ 78)

<SUPER GAIN>



- Register <SUPER GAIN> to a USER button. (→ 66)
- Switch to Manual Mode. (→ 42)

This changes the gain value to a [SUPER GAIN] value. (→ 55)



You can apply a variety of effects to the subject you touch.

■ Setting an Area Mode effect

You can select the following menu items to set an effect to be applied when you touch the subject.



[SW SETUP] → [AREA MODE] → desired setting

[INH]:	Does not apply any effects of Area Mode.
[FOCUS]:	Optimizes the focus automatically for the subject you touch.
[IRIS]:	Optimizes the iris automatically for the subject you touch.
[Y GET]:	Displays the luminance level of the subject you touch.
[FOCUS/IRIS]:	Optimizes the focus and iris automatically for the subject you touch.
[FOCUS/Y GET]:	Optimizes the focus automatically for the subject you touch and displays the luminance level of the subject.

■ Using Area Mode

- Register <AREA> to a USER button. (→ 66)
- Switch to Manual Mode. (→ 42)

1 Press the applicable USER button or touch the applicable USER button icon on the recording screen.

- Area Mode will be enabled and **AREA** will be displayed.

2 Touch the recording screen.

- The area frame **A** will be displayed on the part you have touched. The effect of the selected menu item will be applied.

To turn off Area Mode

(With a USER button)

Press the USER button.

(With a USER button icon)

1 Touch and hold the recording screen to display operation icons.

2 Touch the USER button icon.

To change the size of the area frame

You can rotate the jog dial to change the size of the area frame.

- The area frame is available in three sizes.

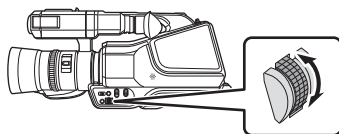
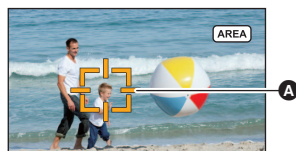

-
- Area Function is not possible in following cases:
 - When a setting in [SCENE MODE] is enabled (→ 114)
 - During Super Slow Recording (→ 78)
 - Area mode is canceled in following cases:
 - If you turn the unit off
 - When the mode switch position is changed
 - If you switch to Intelligent Auto Mode (→ 42)
 - When the setting of [ASPECT CONVERT] is changed (→ 120)
 - When using Area Mode, even if you set zebra function to [MARKER], the luminance display frame will not be displayed. (→ 84)
In addition, the luminance level will not be displayed if [AREA MODE] is set to [FOCUS], [IRIS] or [FOCUS/IRIS].

<PUSH AF>



- Register <PUSH AF> to a USER button. (→ 66)

You can use One Push AF and Push AF. (→ 48)

<CAPTURE>



- Register <CAPTURE> to a USER button. (→ 66)

You can record still pictures or create still pictures from recorded motion pictures. (→ 41, 93)

<EVF/LCD DETAIL>



- Register <EVF/LCD DETAIL> to a USER button. (→ 66)

[EVF/LCD DETAIL] helps you achieve focus easier by emphasizing the outlines of an image displayed on the LCD monitor or the viewfinder. (→ 48)

- These settings will not affect the images actually recorded.

<LCD/EVF OUTPUT>



- Register <LCD/EVF OUTPUT> to a USER button. (→ 66)

This changes how to turn on/off the LCD monitor and Viewfinder. (→ 29)

<LEVEL GAUGE>



- Register <LEVEL GAUGE> to a USER button. (→ 66)

This function displays the horizontal/vertical tilt of the unit with the electronic level.

■ To correct the tilt

(Horizontal direction)

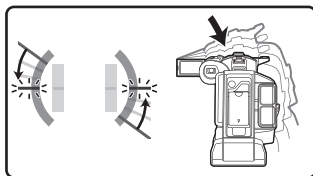

When correcting the leftward tilt

(Vertical direction)

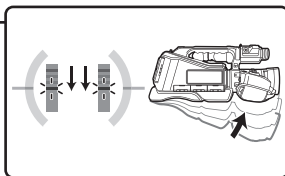

When correcting the downward tilt

- The horizontal tilt display **A** and vertical tilt display **B** appear yellow when there is a tilt, and appear green when there is almost no tilt.
- The maximum tilt display angles are approximately 45° in horizontal direction and 10° in vertical direction.
- The electronic level does not affect the actual recorded images.

-
- This function is not available in the following cases:

- During Freeze Frame (→ 72)
- When color bars are displayed. (→ 83)

- If [SELF SHOOT] (→ 134) is set to [MIRROR], the electronic level will not be displayed when you record yourself.

- Even when the tilt is in the corrected state, an error of approximately 1° may occur.

- In the following cases, the electronic level may not be displayed correctly:

- When moving this unit
- When pointing this unit up or down at an angle closer to perpendicular

<LEVEL SHOT>





- Register <LEVEL SHOT> to a USER button. (→ 66)

This function detects the horizontal tilt of the unit, and automatically corrects it to the level position.

-  is displayed on the screen.

- The icon changes when the tilt exceeds the correction range.

	When the tilt is corrected
	When the tilt is above the correction range

- When the tilt exceeds the correction range, move the unit to the position where  is displayed.

-
- This function is not available in the following cases:

- During Super Slow Recording (→ 78)

- The setting of this function cannot be changed during Freeze Frame. (→ 72)

- [LEVEL GAUGE] turns off if you set [LEVEL SHOT] to [ON]. Conversely, [LEVEL SHOT] turns off if you set [LEVEL GAUGE] to [ON].

- The range that this icon can be displayed correctly the slope is about 45° to the horizontal direction.

- The image may move while zooming depending on the tilt of this unit.
- When recording horizontal images using a tripod, attach the unit on the tripod using [LEVEL SHOT], and set [LEVEL GAUGE] to [ON] again.

<FLASH BAND>



- Register <FLASH BAND> to a USER button. (→ 66)
- Switch to Manual Mode. (→ 42)

If you set this item to [ON], you can compensate for and reduce flash band, a phenomenon that creates markedly different levels of luminance between the top and bottom of the image when recording is performed in an environment where another camera is firing its flash.

- FBC appears on the screen.

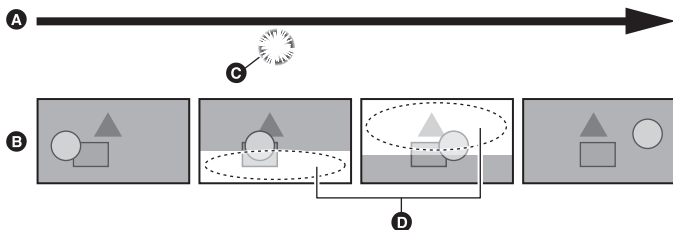

- A** Time flow
- B** Image recorded
- C** Flash firing
- D** Flash band

■ Note on the use of the Flash Band Compensation function

Regardless of whether a flash is fired or not, the Flash Band Compensation function is activated whenever an external light source drastically changes the brightness of the lower half of the screen. The function, as a result, may be activated in recording situations such as when you zoom in or out on a bright window. We recommend using the function in recording situations where flashes are expected to be fired.

Please note that the Flash Band Compensation function may not produce an adequate effect in certain recording situations even when a flash is fired.

- The phenomena below may occur when a flash is fired. These are caused by the Flash Band Compensation function and are not malfunctions.
 - Moving subjects appear as if they have stopped for an instant
 - The resolution deteriorates when a flash is fired.
 - Horizontal lines appear in the image when a flash is fired.
- This function is not available in the following cases:
 - When the frame rate in [REC FORMAT] is 29.97p or 23.98p (→ 118)
 - When a setting in [SCENE MODE] is enabled (→ 114)
 - When using [DIGITAL ZOOM] (→ 70)
 - During Super Slow Recording (→ 78)
 - During Freeze Frame (→ 72)

- The setting will be turned off in the following cases:
 - If you turn the unit off
 - When the mode switch position is changed
 - If you switch to Intelligent Auto Mode
- This function will fix the shutter speed to 1/60. The shutter speed cannot be adjusted.

<PRE-REC>



- **Register <PRE-REC> to a USER button. (→ 66)**

This allows the recording of an image and audio to start before you press the recording start/stop button. AVCHD scenes will be recorded from approximately 3 seconds before the operation, while MOV/MP4 will be recorded from approximately 4 seconds before the operation.

- [P-] is displayed on the screen. After you start recording, the display changes to [P-REC].

- **Aim the unit at the subject beforehand.**

- There is no beep sound.
- This function is not available in the following cases:
 - During Super Slow Recording (→ 78)
 - During the Interval Recording (→ 127)
- In the following cases, a 3 second image that precedes the recording of an AVCHD scene or a 4 second scene that precedes the recording of an MOV/MP4 scene may not be recorded:
 - Immediately after the maximum PRE-REC standby time has elapsed*
 - If the length of time from when [PRE-REC] is set to [ON] to when you start recording is too short
 - When the unit is turned off and on or the mode switch position is changed after PRE-REC is set so the length of time from when you switch to the recording screen until when you start recording is short.
 - When the card slot selected for motion picture recording is switched automatically because you started recording with normal settings or when [2 SLOTS FUNC.] is set to [RELAY REC] (→ 125)

* The maximum PRE-REC standby time is 3 hours. Once PRE-REC is activated, it is automatically deactivated and then re-activated every 3 hours.

- Images displayed on the thumbnail in Playback Mode will differ from the motion pictures displayed at the start of playback.



This enables/disables Super Slow Recording. You can enable this function to record slow motion pictures.

- **Switch to Manual Mode.** (→ 42)
- **Register <SUPER SLOW> to a USER button.** (→ 66)
- **Make the [REC MODE] and [REC FORMAT] settings.** (→ 117, 118)
- Super Slow Recording is available for the following [REC MODE] and [REC FORMAT] settings:

Recording mode	Recording format
MOV, MP4	FHD 1080/59.94p 50M, FHD 1080/29.97p 50M, FHD 1080/23.98p 50M

1 Press USER button or touch USER button icon in the recording screen.

- [SUPER SLOW] will be displayed.
- The frame rate display will change.

(Example)

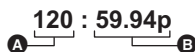

- A** Frame Rate (fps)
- B** Frame rate in [REC FORMAT]

- / will be displayed. Audio is not recorded during recording.

2 Press the recording start/stop button to start recording.

- When recording in Super Slow Recording for the first time since you turned on this unit, a message is displayed, informing you that audio cannot be recorded.

3 Press the recording start/stop button again to stop recording.

- To cancel Super Slow Recording, press USER button, or touch USER button icon.

■ Frame rates and their effects

The slow motion speed during playback varies depending on the frame rate in [REC FORMAT].

Frame rate of [REC FORMAT]	59.94p	29.97p	23.98p
Slow motion speed during playback	1/2× the normal speed	1/4× the normal speed	1/5× the normal speed

- This function can also be set from the menu.
[RECORD SETUP] → [SUPER SLOW REC] (→ 128)
- Super Slow Recording is disabled if any of the following operations is performed:
 - Setting [REC MODE] to [AVCHD]
 - Changing the [REC FORMAT] setting
 - If you switch to Intelligent Auto Mode
- The following functions are canceled:
 - [SCENE MODE] (→ 114)
 - Flash band compensation (→ 76, 117)
 - Relay recording (→ 126)
 - Interval Recording (→ 127)
 - PRE-REC (→ 77, 128)
 - Hybrid Optical Image Stabilizer (→ 83)
 - Area Mode (→ 73)
 - Digital Zoom (→ 70)
 - i.Zoom (→ 44)
 - Slow Shutter (→ 123)
 - Freeze Frame (→ 72)

- When Super Slow Recording is activated, the angle of view will change. (The color of the frame rate value will change to blue.)
- There is a slight gap between the displayed frame rate for Super Slow Recording and the actual frame rate at which Super Slow Recording is performed. Although [120] is displayed on the screen, the actual recording is performed at 119.88 fps.
- The shutter speed cannot be adjusted to a value below 1/120.
- <BLACK FADE> and <WHITE FADE> are disabled. (→ 69)
- Still picture recording cannot be used.
- Even if you press the recording start/stop button as soon as recording has started, it may take some time until the recording stops.
- The maximum continuous recordable time for one scene in Super Slow Recording varies depending on the frame rate of [REC FORMAT]. Recording stops when a certain time has elapsed since the start of the recording, and restarts automatically a few seconds later.

Frame rate of [REC FORMAT]	Maximum continuous recordable time for one scene
59.94p	5 hour
29.97p	2 hour 30 minutes
23.98p	2 hour

<AUTO REC>



- Register <AUTO REC> to a USER button. (→ 66)

This enables/disables a function that controls recording performed with an external device (recorder, etc.) connected to this unit.

1 Select the [HDMI TC OUTPUT] menu.

 : [OUTPUT SETUP] → [HDMI TC OUTPUT] → [ON]

2 Select the [REMOTE REC] menu.

 : [OUTPUT SETUP] → [REMOTE REC] → [ON]

3 Select the [REMOTE REC LINK] menu.

 : [OUTPUT SETUP] → [REMOTE REC LINK] → [OFF]

4 Press USER button or touch USER button icon in the recording screen.

- When HDMI ● is displayed, signals will be transmitted, prompting the external device to start recording.
- To stop the recording being performed with the external device, press the applicable USER button or touch the applicable USER button icon again. When HDMI III is displayed, signals will be transmitted, prompting the external device to stop the recording.

<O.I.S.>



- Register <O.I.S.> to a USER button. (→ 66)

This enables/disables the Image Stabilizer. (→ 83)

<ZEBRA>



- Register <ZEBRA> to a USER button. (→ 66)

You can switch between the zebra and marker displays. (→ 84)

<PICTURE TONE>



- Register <PICTURE TONE> to a USER button. (→ 66)

Changes the contrast of the overall image.

Press USER button or touch USER button icon in the recording screen.

- Switches the setting each time the button is pressed.

[STANDARD] ↔ [SHARP]

[STANDARD]: This mode is standard image setting.

[SHARP]: This mode is high-contrast image setting for both color and luminance.

- The setting is also applied to the menu item [PICTURE TONE].

<WHITE BAL>



- Register <WHITE BAL> to a USER button. (→ 66)

You can switch between Auto White Balance Mode and Manual White Balance Mode by pressing the button. (→ 56)

In addition, if you press and hold the button, Auto White Balance or Auto Black Balance adjustment is performed. (→ 58)

<MENU>



- Register <MENU> to a USER button. (→ 66)

The menu can be displayed.



Using Operation Icons

You can use convenient functions just by the easy operation of touching the screen.

1 Touch the LCD monitor in the recording screen.

- The operation icons are displayed.

2 Touch an operation icon.

- The following function is available. Refer to the respective pages for the operation.



	Resets the counter (→ 65)
	Counter display (→ 63)
	Switching the screen indications/mode information display
	Image Stabilizer Function (→ 83)
	Color Bar Screen (→ 83)
	Zebra (→ 84)
	USER Button Icon (→ 66)
	Switches between Auto Gain Mode/Manual Gain Mode (→ 54)
	Switches between Auto White Balance Mode/Manual White Balance Mode (→ 56)
	Switches between Auto Shutter Mode/Manual Shutter Mode (→ 59)

- If you touch the screen while an operation icon is being displayed or do not touch the icon for a certain period, it will disappear. To display again, touch the screen.

Switching the screen indications/mode information display

You can hide screen indications other than the counter display, zebra display, marker display, and safety zone display. (→ 142)

Touch .

- To cancel this display mode, touch again.

■ To display the Mode Information

If you touch and hold , a list of functions assigned to the USER buttons (USER1 to USER3) and the settings of [SUB REC BUTTON] and [SUB ZOOM] are displayed.

- If the screen is touched while mode information is displayed or no touch operation is performed for a specific period of time, the information will disappear.

Image Stabilizer Function



Use the Image Stabilizer to reduce the effects of shake during recording.

This unit is equipped with Hybrid Optical Image Stabilizer.

Hybrid Optical Image Stabilizer is a hybrid of Optical and Electrical Image Stabilizer.

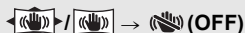
Touch  **to switch the Image Stabilizer on/off.**



- When [HYBRID O.I.S.] is [ON],  is displayed. When [OFF],  is displayed.
- You can also enable or disable this function with the applicable USER button. (→ 80)
- This item cannot be set during Freeze Frame (→ 72)

■ Changing Image Stabilizer Mode

Select the menu.

 : [SW SETUP] → [HYBRID O.I.S.] → [ON] or [OFF]

When set to [ON], you can further improve image stabilization for holding the unit and recording a distant subject with zoom.



- Optical Image Stabilizer will be disabled and the setting cannot be changed in the following cases:
 - When Optical Image Stabilizer is set to  (setting canceled)
 - During Super Slow Recording (→ 78)
- The setting of this function cannot be changed during Freeze Frame. (→ 72)

- Stabilization may not be possible under strong shaking conditions.
- When using a tripod, we recommend that you set the Image Stabilizer to  (setting canceled).

Color Bar Screen

You can display color bars, which are convenient for adjusting the picture quality of a TV.

Touch  .

- To cancel, touch  again.
- It will be canceled when the unit is turned off.
- While the color bar is displayed, a test tone will be output from the headphone terminal, HDMI terminal and AUDIO OUT terminal. (the test tone is output at 1 kHz.)
It will not be output from the speaker of this unit.
- Different color bars are displayed depending on the [BARS TYPE] setting. (→ 124)
- The test tone volume differs depending on the [TEST TONE] setting. (→ 130)
- You can record color bars as motion pictures, but not as still pictures.
- If you touch  while recording color bars as a motion picture, you can stop displaying the color bars. To display them again, stop the recording and touch  .

Zebra

You can switch between the zebra display and marker display.

Touch **ZEBRA**.

Each time the icon is selected, the indication changes in the following order:

Zebra 1 → Zebra 2* → Marker* → setting canceled

* It is not displayed when the [ZEBRA DETECT 2]/[MARKER] is set to [OFF]. (→ 131)

- You can also use this function with a USER button. (→ 80)

(When Zebra 1 is set)

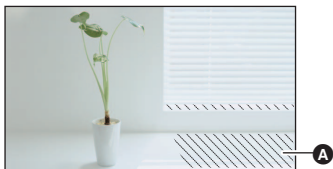

(When Marker is set)

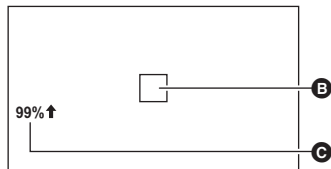

Zebra display:

Parts where white saturation (color saturation) is likely to occur (extremely brightly lit or shiny parts) are displayed with diagonal lines (zebra pattern **A**).

Marker display:

Displays the luminance level of the center of the screen (luminance display frame **B**) in %.

It makes the adjustment of the brightness of the object easier, by checking the luminance level of the object, when recording same object in different surroundings.

- Luminance level **C** is displayed between 0% and 99%. It will be displayed as 99% ↑ when it is over 99%.

-
- This item cannot be set during Freeze Frame. (→ 72)
 - You can record an image with little white saturation if you manually adjust the shutter speed or brightness not to display zebra pattern. (→ 53, 59)
 - The zebra pattern does not appear on the images actually recorded.
 - It is also possible to adjust the level of the zebra pattern to be displayed. (→ 131)
 - It is also possible to change the [ZEBRA MODE] setting to change the display time for the zebra pattern display. (→ 124)

Using of jog dial

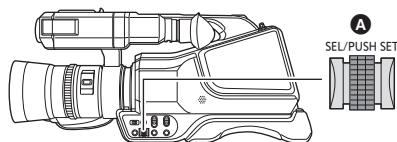

A Jog dial

Selecting/setting items

You can select and set menu items (→ 36), etc. using the jog dial.

1 Rotate the jog dial on the menu screen, etc., to move the cursor.

- The selected item will be displayed in yellow.



2 Push the jog dial to set.



Menu operations for setting a value

When a menu that lets you set a value is displayed, select the value display before adjusting the setting.

- You cannot select ▲/▼/◀/▶ with the jog dial when a screen that lets you adjust a value is displayed.

(Example: When adjusting the brightness for [LCD SET])

1 Rotate the jog dial to move the cursor to the value display **B**.

- Push the jog dial to select the value display.

2 Rotate the jog dial to adjust the setting.

- Pushing the jog dial will set the value you have selected.

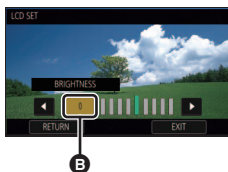









- The jog dial also allows you to select/set operation icons, thumbnails, etc.
- Parts that are finger-touch sensitive can be operated with the jog dial. (Excluding some functions)



Selecting functions/Adjusting function settings

You can select the following functions and adjust their settings using the jog dial.
You can also switch between the functions and adjust their settings.

(When the recording screen is displayed)

Jog dial icon	Functions	Settings
 GAIN	Gain adjustment (→ 54)	Adjusts the gain value.
 SHUTTER	Shutter speed (→ 59)	Adjusts the shutter speed.
 WB	White balance (→ 56)	Changes the white balance mode
 VAR	VAR adjustment (→ 58)	Adjusts the White Balance VAR value.
 AREA	Area Mode (→ 73)	Changes the area frame setting.
 ASSIST	Focus Assist (→ 49)	Changes the magnification level of the magnified display
 VOLUME	Headphone Volume Adjustment (→ 87)	Adjusts the headphone volume.
 MIC VOLUME	Audio level adjustment (→ 61)	Adjusts the audio input level.
 ICONS	Allows you to display/select operation icons on the recording screen.	—



(When the playback screen is displayed)

Jog dial icon	Functions	Settings
 VOLUME	Volume adjustment (→ 90)	Adjusts the speaker and headphone volume during motion picture playback.
 ICONS	Allows you to display/select operation icons on the playback screen.	—

To switch the function set in the recording screen

1 Set so the function to be used can be selected.

- If the desired function cannot be selected, use the settings below.

Functions	Settings to be changed in advance
Gain adjustment	Touch the manual icon  to switch to Manual Gain Mode. (→ 54)
Shutter speed	Touch the manual icon  to switch to Manual Shutter Mode. (→ 59)
White balance	Touch the manual icon  or press the USER button assigned as <WHITE BAL> to switch to Manual White Balance Mode. (→ 56)
VAR adjustment	Rotate the jog dial in Manual White Balance Mode to set the White Balance mode to [VAR]. (→ 56)
Area Mode	Press the USER button assigned as <AREA> to set [AREA MODE] to ON. (→ 73)
Focus Assist	Set [FOCUS ASSIST 1]/[FOCUS ASSIST 2] to [EXPAND] or [BOTH]*, and press the USER button assigned as <FOCUS ASSIST 1>/<FOCUS ASSIST 2> to set Focus Assist to ON. (→ 49) * This item is only set in [FOCUS ASSIST 1].
Headphone Volume Adjustment	Connect headphones to this unit.
Audio level adjustment	—

2 Rotate the jog dial in the recording screen to switch to the desired jog dial icon (yellow display: Function Selection Mode).

3 Push the jog dial.

- The jog dial icon for the selected function turns white. (Function Execution Mode)
- The operation icon can be selected when [ ICONS] is selected. (→ 82)
- The selected function can be adjusted by rotating the jog dial.



■ Headphone Volume Adjustment

Adjust the volume of the headphone while recording.

- Set [VOLUME] to [ON]. (→ 130)

1 Connect headphones to the headphone terminal.

2 Rotate the jog dial to adjust the volume.

- You can also adjust the volume by touching  / . Not performing touch operations after the adjustment allows you to exit the setting.
- Actual volume to be recorded does not change.

3 Push the jog dial to finish the adjustment.

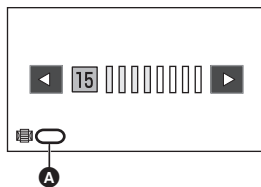

A [VOLUME]



Motion picture/Still picture playback

1 Set this unit to playback mode. (→ 28)

2 Touch the play mode select icon **A**.

C Media display

The selected media is displayed in yellow.

3 Select the media **D** you wish to play back.

4 (To set this unit to Motion Picture Playback Mode)

Touch the desired recording mode **E and recording format **F** for playback.**

- Recording mode options with recorded scenes are displayed in green.
- The available recording format options differ depending on the recording mode option you have touched.
- Touch [ENTER].
- A recording mode icon **E** will be displayed on the thumbnail display. (**MOV** / **MP4** / **AVCHD**)

(If you have touched the recording mode option [MOV] or [MP4])

- After you have touched a recording format option, one of the following icons will be displayed on each thumbnail. The icon to be displayed differs depending on the size of recording format.
 - FHD** : Scenes recorded in FHD (1920×1080)
- If you touch the recording format option [ALL], all scenes of the same recording mode in the selected media are displayed.

The thumbnails of scenes recorded on other devices with different system frequencies are indicated with . This unit cannot play back these scenes.

- (If you have touched the recording mode option [AVCHD])

After you have touched a recording format option, one of the following icons will be displayed on each thumbnail.

- PS** : Scenes recorded in [PS 1080/59.94p]
- PH** : Scenes recorded in [PH 1080/59.94i]/[PH 1080/23.98p]
- HA** : Scenes recorded in [HA 1080/59.94i]
- HE** : Scenes recorded in [HE 1080/59.94i]
- PM** : Scenes recorded in [PM 720/59.94p]
- SA** : Scenes recorded in [SA 480/59.94i]

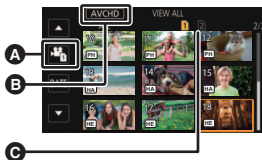

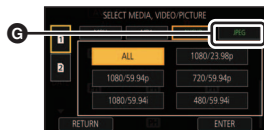

(To set this unit to Still Picture Playback Mode)

Touch the still picture (JPEG) .



5 Touch the scene or the still picture to be played back.



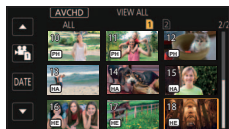





- Next (Previous) page can be displayed by touching  / .
- You can change the playback media by pressing the USER button to which <SLOT SEL> is registered. (→ 66)





6 Select the playback operation by touching the operation icon .





- If you touch the screen while an operation icon is being displayed or do not touch the icon for a certain period, it will disappear. To display again, touch the screen.

Motion picture playback	Still picture playback
<p>: Playback/Pause</p> <p>: Fast rewind playback*</p> <p>: Fast forward playback*</p> <p>: Stops the playback and shows the thumbnails.</p>	<p>: Slide show (playback of the still pictures in numerical order) start/pause.</p> <p>: Plays back the previous picture.</p> <p>: Plays back the next picture.</p> <p>: Stops the playback and shows the thumbnails.</p>

* When touched twice, the fast forward/fast rewind speed increases. (Screen display will change to  /  .)

Change the thumbnail display

While the thumbnail is displayed, the thumbnail display changes in the following order if the zoom lever or the sub zoom lever is operated to  side or  side.

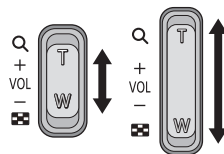

( side)

( side)

20 scenes ↔ 9 scenes ↔ 1 scene ↔ Scene information display*

* Detailed information of the scene is displayed when playing back motion pictures. Following information is displayed.

START TC and DURATION are displayed only for AVCHD scenes.

- START TC
- DATE
- TIME ZONE
- DURATION
- REC MODE
- FORMAT

- If you switch between Recording Mode/Playback Mode with the mode switch, you will return to 9-scene display.
- By displaying in 1 scene, recording date and time are displayed when playing back motion pictures, and recording date and file number when playing back still pictures.

Speaker/Headphone volume adjustment

Operate the volume lever, sub zoom lever or jog dial to adjust the speaker/headphone volume during Motion Picture Playback Mode.

Adjusting the volume with the volume lever/sub zoom lever

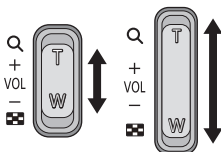
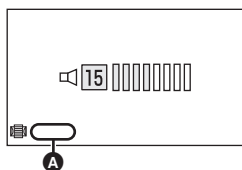

Towards “+”:
Increases the volume

Towards “-”:
Decreases the volume

A [VOLUME]

Adjusting the volume with the jog dial

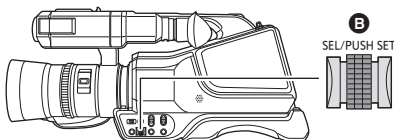

B Jog dial

- 1 Push the jog dial while [ VOLUME] is displayed.



2 Rotate the jog dial to adjust the volume.

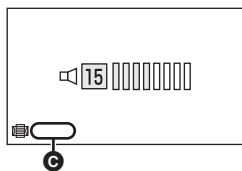

C [VOLUME]



3 Push the jog dial to finish the adjustment.

- Sound will be heard only during normal motion picture playback.
- If pause play is continued for 5 minutes, the screen returns to the thumbnails.
- If you set recording format to [ALL] and play back a scene, the screen may turn dark momentarily when it switches to another scene.

Motion picture compatibility









- This unit is based on AVCHD Progressive/AVCHD.
- Motion pictures recorded with the unit may not be played back correctly or at all on another device, even if it supports their format. (Please check compatibility in the instruction manual of your device.)
- Motion pictures recorded with devices other than this unit are not supported by this unit.

Still picture compatibility

- This unit is compliant with the unified standard DCF (Design rule for Camera File system) established by JEITA (Japan Electronics and Information Technology Industries Association).
- The file format of still pictures supported by this unit is JPEG. (Not all JPEG formatted files will be played back.)
- This unit may degrade or not play back still pictures recorded or created on other products and other products may degrade or not play back still pictures recorded on this unit.
- Depending on the playback device, still pictures may be played back with picture sizes different from the ones with which they were recorded.

Motion picture playback using operation icon

For details on the basic playback operations, refer to page 88.

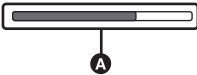
Playback operation	Playback display	Operating steps
Skip playback (to the start of a scene)	<p>During Playback</p> 	<p>Touch the LCD monitor and slide from right to left (from left to right) during playback.</p>
Slow-motion Playback	<p>During Pause</p> 	<p>With the playback paused, continue touching .</p> <p>( is for slow rewind playback.)</p> <p>Slow-motion Playback is performed continuously while the display is touched and held.</p> <ul style="list-style-type: none"> Normal playback is restored when you touch . For slow rewind playback, the intervals between frames and the display time per frame vary depending on the type of the scene.
Frame-by-frame Playback	<p>During Pause</p> 	<p>With the playback paused, touch .</p> <p>(Touch  to advance the frames one at a time in the reverse direction.)</p> <ul style="list-style-type: none"> Normal playback is restored when you touch . For reverse Frame-by-frame Playback, the intervals between frames vary depending on the type of the scene.
Direct playback	<p>During Playback</p> 	<p>Touch the direct playback bar A or slide it while touching.</p> <ul style="list-style-type: none"> The playback pauses temporarily and skips to the position touched or slid to while touching. (When you touch the bar or slide it while touching during playback) Playback will start by releasing your touching or sliding finger.

- Scenes that are large in file size may cause this unit to respond slower to operations performed by the user or cause certain operations performed by this unit to become slower.



Useful functions

Creating still picture from motion picture

You can save a frame of a recorded motion picture as a still picture. The picture size with which a still picture will be recorded differs depending on the picture size of [REC FORMAT] with which the motion picture was recorded.

Recording format	Aspect ratio	Picture size
[REC FORMAT] setting with a size of FHD (1920×1080)	16:9	2.1M 1920×1080
[PS 1080/59.94p]/[PH 1080/59.94i]/ [PH 1080/23.98p]/[HA 1080/59.94i]/ [HE 1080/59.94i]		
[PM 720/59.94p]		0.9M 1280×720

While playing back a motion picture, touch the  at the scene you want to save it as a still picture.

- If you register <CAPTURE> to any of the USER buttons 1–3, you can capture a still picture by pressing the USER button. For information on how to register functions to the USER buttons, refer to page 66.
- It is convenient to use Pause, Slow-motion Playback and Frame-by-frame Playback.
- Date of the motion picture was recorded will be registered as date of the still picture.
- Quality will be different from the normal still picture.



-
- Please refer to page 156 about approximate number of recordable pictures.

Repeat Playback

Playback of the first scene starts after playback of the last scene finishes.

Select the menu.

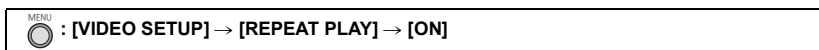

The  indication appears on the full screen views.

- All the scenes displayed in the thumbnail will be repeatedly played back.

-
- Repeat Playback cannot be used for the slide show playback of the still pictures. (→ 89)

Resuming the previous playback

If playback of a scene was stopped halfway, the playback can be resumed from where it was stopped.

Select the menu.

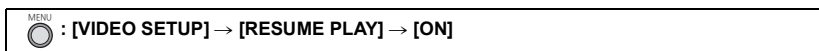

If playback of a motion picture is stopped,  appears on the thumbnail view of the stopped scene.

-
- The memorized resume position is canceled if one of the following operations is performed. (The setting of [RESUME PLAY] does not change):
 - If you turn the unit off
 - When the mode switch position is changed
 - Changing the recording mode and recording format for playback in Playback Mode

Playing back scenes or still pictures by date

The scenes or still pictures recorded on the same day can be played back in succession.

1 Touch the date select icon **A**.

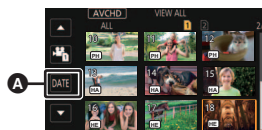

2 Touch the playback date.

- The scenes or still pictures recorded on the date selected are displayed as thumbnails.

3 Touch the scenes or still picture to be played back.

- Dates cannot be selected while the thumbnail screen for the recording format [ALL] of the recording mode [MOV]/[MP4] is displayed.
- If you switch between Recording Mode/Playback Mode with the mode switch, you will return to playback of all scenes.
- In cases such as those described below, scenes and still pictures are grouped separately on the date list, and -1, -2... may be added after the date:
 - When the number of scenes exceeds 99
 - When the number of still pictures exceeds 999
 - When you change the [REC FORMAT] setting (→ 118)
 - When you set [REC MODE] to [AVCHD] and set Interval Recording to an option other than [OFF] (→ 127)
 - When [NUMBER RESET] is performed (→ 138)
- Scenes recorded with the following [REC FORMAT] settings are grouped separately on the date list. A recording format icon will be displayed next to the date.

Recording format	Icon to be displayed
[REC FORMAT] setting with a size of FHD (1920×1080)	FHD
[PS 1080/59.94p]	PS
[PH 1080/59.94i]/[PH 1080/23.98p]	PH
[HA 1080/59.94i]	HA
[HE 1080/59.94i]	HE
[PM 720/59.94p]	PM
[SA 480/59.94i]	SA

-  is displayed after the date in the list by date for the still pictures created from the motion picture. (→ 93)

Deleting scenes/still pictures

Deleted scenes/still pictures cannot be restored, so perform appropriate confirmation of the contents before proceeding with deletion.

- Set the mode switch to . (→ 28)

■ To delete the scene or still picture being played back

Touch while scenes or still pictures to be deleted are being played back.



■ To delete scenes or still pictures from the thumbnail display

- Switch to the thumbnail display of the scenes or still pictures to delete. (→ 88)

1 Select the menu.

MENU



: [VIDEO SETUP] or [PICT. SETUP] → [DELETE] → desired setting

[ALL SCENES]:

All the scenes or still pictures displayed as thumbnails can be deleted.

(When playing back scenes or still pictures by date, all scenes or still pictures of the selected date will be deleted.)

[MULTI]:

Multiple scenes or still pictures can be selected and deleted.

[SINGLE]:

Single scene or still picture can be selected and deleted.

- Protected scenes/still pictures cannot be deleted.

2 (When [MULTI] is selected in Step 1)

Touch the scene/still picture to be deleted.

- When touched, the scene/still picture is selected and the indication appears on the thumbnail. Touch the scene/still picture again to cancel the operation.
- Up to 99 scenes can be selected to be deleted.

(When [SINGLE] is selected in Step 1)

Touch the scene/still picture to be deleted.

3 (When [MULTI] is selected in Step 1)

Touch [Delete].

- To continuously delete other scenes/still pictures, repeat Steps 2-3.



When you stop deleting halfway:

Touch [CANCEL] or press MENU button while deleting.

- The scenes or still pictures that have already been deleted when the deletion is canceled cannot be restored.

To complete editing:

Touch [Return] or press MENU button.

-
- The following scenes/still pictures cannot be deleted:
 - Scenes/still pictures that cannot be played back (the thumbnails are displayed as )
 - Scenes recorded on other devices with different system frequencies (thumbnails indicated with )
 - In case of [ALL SCENES], the deletion may take time if there are many scenes or still pictures.
 - If you delete scenes recorded on other products or still pictures conforming to DCF standard with this unit, all the data related to the scenes/still pictures may be deleted.
 - When still pictures recorded on an SD card by other products are deleted, a still picture (other than JPEG) that cannot be played back on this unit, may be erased.

Protecting scenes/still pictures



Scenes/still pictures can be protected so that they are not deleted by mistake.

(Even if you protect some scenes/still pictures, formatting the SD card will delete them.)

- Set the mode switch to  . (→ 28)

1 Select the menu.

 : [VIDEO SETUP] or [PICT. SETUP] → [SCENE PROTECT]

2 Touch the scene/still picture to be protected.

- When touched, the scene/still picture is selected and the  indication appears on the thumbnail. Touch the scene/still picture again to cancel the operation.
- Touch [Return] to complete the settings.

Copying between SD cards

Motion pictures or still pictures recorded with this unit can be copied between SD Cards inserted in this unit.

- Copying is not possible if the type of the source SD card (SDHC Memory Card/SDXC Memory Card) is different from that of the target SD card.

■ Check the used space of the copy destination

It is possible to check the used space of the SD Card by [MEDIA STATUS]. (→ 136)

- By displaying in 1 scene, recording date and time can be checked when playing back motion pictures, and recording date and file number when playing back still pictures.
- Depending on the media condition, some remaining capacity of the SD Card may not be used.

Copying

1 Set the mode switch to . (→ 28)

- Use a sufficiently charged battery or the AC adaptor.

2 Select the menu.

: [COPY] → [SELECT COPY]

- [→]: Copies from card 1 to card 2
- [→]: Copies from card 2 to card 1
- [→]*: Copies from card 1 to an external media device
- [→]*: Copies from card 2 to an external media device

* Displayed only when the external media is connected. (→ 107)

3 Touch desired items following the screen display.

- It will return to the previous step by touching [Return].
- (When [SELECT SCENES] is selected)
When touched, the scene/still picture is selected and the indication appears on the thumbnail. Touch the scene/still picture again to cancel the operation.
- (When [SELECT DATE] is selected)
When touched, the date is selected and surrounded by red. Touch the date again to cancel the operation.
- Up to 99 scenes/still pictures or 99 dates can be set in succession.

4 Touch [EXIT] when the copy complete message is displayed.

- The thumbnail view of the copy destination is indicated.

When you stop copying halfway

Touch [CANCEL] while copying.

If you will delete the motion pictures or still pictures after copying is complete, be sure to play back the motion pictures or still pictures to check that they have been copied to correctly before deleting.

- Depending on the following conditions, the time it takes for copying may be longer.
 - The number of recorded scenes is large.
- If some motion pictures or still pictures have already been recorded to the copy destination, then the same date may be assigned or images may not display by date when the list by date is selected.
- Motion pictures that have been recorded on another device may not be copied. Data recorded on a PC cannot be copied.
- The settings for the copied motion pictures and still pictures will be cleared if the protected motion pictures or still pictures are copied.
- The order in which the scenes or still pictures were copied cannot be changed.

Connecting Headphones, a Remote Control or an External Monitor

Headphones

You can connect headphones (commercially-available) to the headphone output jack (3.5 mm (0.14 ") diameter stereo mini jack).

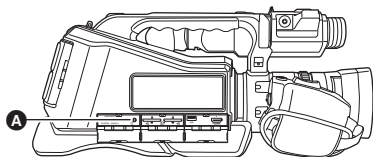

A Headphone output jack

- Sound is not output from the speaker when headphones are connected.

Remote control



You can connect a remote control (commercially-available) to either of the CAM REMOTE terminals (FOCUS IRIS or ZOOM S/S).

- Connecting a remote control to the FOCUS IRIS terminal (3.5 mm (0.14 ") diameter mini jack) allows you to remotely control the focus and iris.
- Connecting a remote control to the ZOOM S/S terminal (2.5 mm (0.1 ") diameter super-mini jack) allows you to remotely control the zoom and start/stop recording.

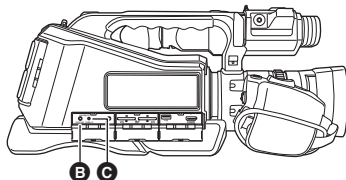

B FOCUS IRIS terminal
C ZOOM S/S terminal

- Do not connect any device other than a remote control to the CAM REMOTE terminals. Doing so may change the image brightness or cause the image to be out of focus.

(When a remote control is connected to the FOCUS IRIS terminal)

- Priority for iris adjustment is given to the remote control. It is not possible to adjust the iris with the multi-manual ring of this unit.
- It is not possible to use the remote control in the Intelligent Auto Mode.

Confirm the terminals on your TV and use a cable compatible with the terminals. Image quality may vary with the connected terminals.

- A** High quality
- 1** HDMI terminal
- 2** Video terminal

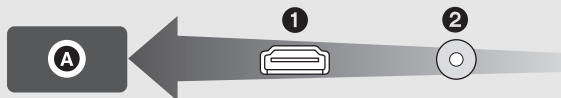

- If you connect this unit to an HDMI compatible high definition TV and then play back the recorded high definition images, you can enjoy them in high resolution with high quality sound.

1 Connect this unit to a TV.

- Check that the plugs are inserted as far as they go.

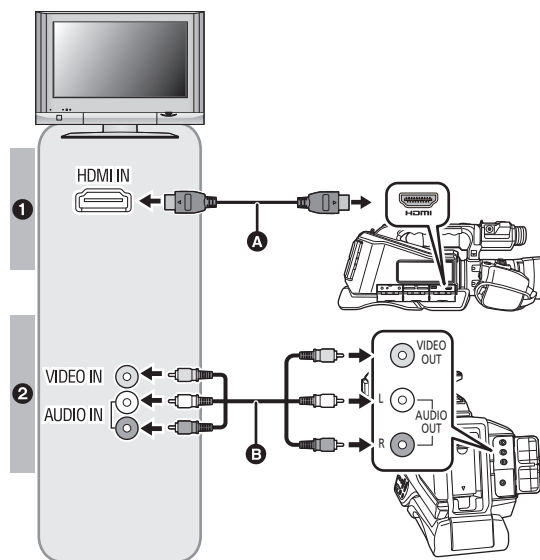

- A** HDMI cable (commercially-available)
- Be sure to connect to the HDMI terminal.
- For information on external output resolution settings, refer to page 103.
- B** AV cable (commercially-available)

Picture quality

- 1** High-definition images when connecting to HDMI terminal
- 2** Standard images when connecting to video terminal

2 Select the video input on the TV.

- Example:
Select the [HDMI] channel with a HDMI cable.
Select the [Video 2] channel with an AV cable.
(The name of the channel may differ depending on the connected TV.)
- Check the input setting (input switch) and the audio input setting on the TV. (For more information, please read the operating instructions for the TV.)

3 Play back the recorded images of this unit.

**When connecting with an HDMI cable using an HDMI-to-DVI converter, etc., be sure to connect the HDMI cable to the connector of this unit last.
Connecting the HDMI cable to the connector of this unit first may result in malfunction.**

- This unit is not compatible with the VIERA Link.
 - Use a commercially-available High Speed HDMI cable.
If possible, we recommend using a cable with a length of 3 m (9.84 feet) or less.
 - If you connect this unit to the TV when this unit is set to Recording Mode, a squealing sound* may be output. Before connecting this unit, set it to Playback Mode.
- * The microphone may pick up the sound from the speakers, producing an abnormal sound.
- When an HDMI cable is connected to this unit, images and audio are not output from the VIDEO OUT terminal and AUDIO OUT terminal.
 - When this unit is connected to a TV with an AV cable, set [RESOLUTION] to [DOWN CONV.].
 - Some screens, such as the menu screen, may be displayed in reduced sizes on the TV.

■ To watch images on a regular TV (4:3) or when both sides of the images do not appear on the screen

Change the menu setting to display the images correctly. (Check the TV setting.)

Select the menu.



 : [OUTPUT SETUP] → [RESOLUTION] → [DOWN CONV.]

 : [OUTPUT SETUP] → [DOWN CONV.] → desired setting

[SIDE CROP]:	Outputs an image by fitting it to the height of the TV screen
[LETTERBOX]:	Outputs an image by fitting it to the width of the TV screen
[SQUEEZE]:	Outputs an image by compressing it in the horizontal direction to fit it in the screen.

- This item is fixed to [SQUEEZE] in the following cases:
 - When [REC FORMAT] is set to [SA 480/59.94i]

Example of images with a [16:9] aspect ratio on a regular TV (4:3):

[DOWN CONV.] setting	
[LETTERBOX]	[SQUEEZE]
	

- When [DOWN CONV.] is set to [SIDE CROP], the sides of an image will be cut off, causing some icons on the TV to be hidden from the TV screen.
- If a wide-screen TV is connected, adjust the aspect setting on the TV. (Refer to the operating instructions of the TV for details.)

■ To display the on-screen information on the TV

When the menu setting is changed, the information displayed on the screen (operation icon and Counter display etc.) can be displayed/not displayed on the TV.

 : [DISP SETUP] → [VIDEO OUT OSD] → [ON] or [OFF]

- This item is set to [OFF] in the following situations when this unit is in Recording Mode:
 - During auto recording (→ 80, 129)

The recorded pictures can be played back on a TV with an SD Memory Card slot

- It may not be possible to play back scenes on the TV depending on the [REC FORMAT] or [REC MODE].
- For details on how to play back, please read the operating instructions for the TV.

Setting the external output resolution

Change the setting for outputting images to a TV or other external device (recorder, etc.).

Select the menu.

 : [OUTPUT SETUP] → [RESOLUTION] → desired setting

[SYSTEM]/[1080p]/[1080i]/[DOWN CONV.]

- [SYSTEM] automatically sets the output resolution according to the setting in [REC FORMAT]. If the images are not output on the TV/external device when the setting is [SYSTEM], switch to the method [1080p], [1080i] or [DOWN CONV.] which enables the images to be displayed on your TV/external device. (Please read the operating instructions for the TV/external device.)
 - [DOWN CONV.] outputs images in standard picture quality.
 - Select [DOWN CONV.] when connecting with the AV cable (commercially-available).
-
- When [REC FORMAT] is set to [SA 480/59.94i], [RESOLUTION] is fixed to [SYSTEM].
 - [RESOLUTION] cannot be set during Freeze Frame. (→ 72)
 - Images may not be displayed on the external device for several seconds in some cases, such as when changing between scenes.

About external output resolutions

The external output resolution varies depending on the [RESOLUTION] setting and connected terminal.

- When [RESOLUTION] is set to [SYSTEM], the external output resolution varies depending on the picture size and frame rate in [REC FORMAT].

Setting		External output resolution	
Picture size/Frame rate in [REC FORMAT]	[RESOLUTION] setting	HDMI OUT terminal	VIDEO OUT terminal
FHD (1920×1080)/ 59.94p, PS 1080/59.94p	[SYSTEM]	1080/59.94p	—
	[1080p]		
	[1080i]		
	[DOWN CONV.]	480/59.94p	480/59.94i
FHD (1920×1080)/ 59.94i, PH 1080/59.94i, HA 1080/59.94i, HE 1080/59.94i	[SYSTEM]	1080/59.94i	—
	[1080p]	1080/59.94p	
	[1080i]	1080/59.94i	
	[DOWN CONV.]	480/59.94p	480/59.94i
FHD (1920×1080)/ 29.97p	[SYSTEM]	1080/29.97p	—
	[1080p]	1080/59.94p	
	[1080i]	1080/59.94i	
	[DOWN CONV.]	480/59.94p	480/59.94i
FHD (1920×1080)/ 23.98p, PH 1080/23.98p	[SYSTEM]	1080/23.98p	—
	[1080p]	1080/59.94p	
	[1080i]	1080/59.94i	
	[DOWN CONV.]	480/59.94p	480/59.94i
PM 720 (1280×720)/ 59.94p	[SYSTEM]	720/59.94p	—
	[1080p]	1080/59.94p	
	[1080i]	1080/59.94i	
	[DOWN CONV.]	480/59.94p	480/59.94i
SA 480 (720×480)/ 59.94i	[SYSTEM]	480/59.94p	480/59.94i
In Playback Mode (still picture)	[SYSTEM]	1080/59.94p	—
	[1080p]		
	[1080i]		
	[DOWN CONV.]	480/59.94p	480/59.94i

- If you enable Super Slow Recording when [RESOLUTION] is set to [SYSTEM], the resolution will be set to either 1080/59.94p. (→ 78)



Importing to PC

Image data can be imported to a PC for editing by inserting the SD card used for recording with the unit into that PC.

- A PC with an SD card slot or an SD card reader is required.
-
- When performing reading/writing between a PC and an SD card, be aware that some SD card slots built into PCs and some SD card readers are not compatible with the SDHC Memory Card or SDXC Memory Card.
 - **Data on SDXC Memory Cards cannot be detected, depending on the PC. Check that the PC supports SDXC Memory Cards.**

About the PC display

When you insert an SD card recorded with the unit into a PC for editing, a removable disk (example:

 CAM_SD (F:)) is displayed in [This PC].

Data recorded using AVCHD format has excellent compatibility with computers, due to its file form; however, it contains not just image and sound data, but also various important information, and it is associated using a folder structure which is like a figure. If even part of this information is changed or erased, faults may occur; for example, it may not be possible for the data to be recognized as AVCHD data, or it may no longer be possible for the SD card to be used in an AVCHD device.

Example folder structure of a SD card:

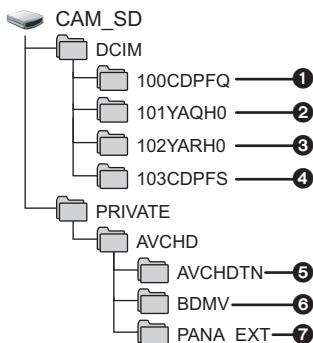

The following data will be recorded.

- 1 Up to 999 still pictures in JPEG format ([01000001.JPG] etc.)
- 2 MOV format motion picture data ([01000001.MOV], etc.)
- 3 MP4 format motion picture data ([01000001.MP4], etc.)
- 4 JPEG format still pictures created from the motion picture
- 5 The motion picture thumbnails
- 6 AVCHD format motion picture files ([00000.MTS] etc.)
- 7 For management

■ Folder names for motion picture data recorded in MOV/MP4 format

The fifth, sixth, and eighth characters of the folder name of a recorded MOV/MP4 scene are determined by its frame rate, motion picture format, and camera number setting, respectively.

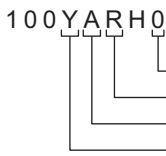

- A** Camera number setting (→ 120)
- B** Motion picture format
- C** Frame rate
- D** Picture size

(Example) If the folder name is 100YARH0:

Motion picture data that has a picture size of 1920×1080 , frame rate of 59.94 fps, and motion picture format categorized as progressive recording (MP4 and LPCM) is stored.

Picture size	Y: 1920×1080
Frame rate	A: 59.94 fps C: 29.97 fps F: 23.98 fps
Motion picture format	J: Interlace recording (MOV, LPCM) K: Interlace recording (MP4, LPCM) Q: Progressive recording (MOV, LPCM) R: Progressive recording (MP4, LPCM)
Camera number setting	0 to 9: Numbers between 0 and 9 is set in [CAMERA NUMBER SET]. A to G: Numbers between 10 and 16 is set in [CAMERA NUMBER SET].

- Do not delete the SD card's folders on a PC. Doing so may make the SD card unusable in this unit.
- When data not supported by this unit has been recorded on a PC, it will not be recognized by this unit.
- Always use this unit to format SD cards.



Copying/playing back with an external media device

● In these Operating Instructions, "USB hard disk drive" is indicated as "USB HDD".
If you connect an external media device, such as USB HDD or USB flash memory (commercially-available) to this unit, you can copy motion pictures and still pictures recorded on this unit to an external media device.

It can also play back the scenes and still pictures copied to the external media device.

- This unit supports USB 2.0.
- You can copy scenes and still pictures recorded with this unit while maintaining the image quality.
- Please read the operating instructions of the external media device for how to use it.

Preparing for copying/playing back

Refer to the following support site for information about an external media device.

http://panasonic.jp/support/global/cs/e_cam

(This Site is English only)

When the external media device that requires formatting is connected, a message is displayed. Follow the instructions on the screen to format it.

Once the external media device has been formatted, all data stored on it will be deleted. The data cannot be recovered.

- This unit formats the external media device in exFAT*.
- In the following cases, an external media device cannot be used by connecting it to this unit:
 - An external media device with a capacity below 32 GB or above 2 TB
 - When an external media device has two or more partitions
 - If an external media device is in a format other than FAT32* or exFAT
 - When connected by using a USB hub
- * FAT32 is a format used for SDHC Memory Cards.
exFAT is a format used for SDXC Memory Cards.
- You cannot copy scenes recorded on an SDXC Memory Card to an external media device in FAT32 format.

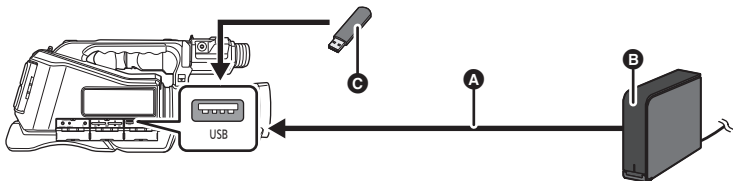

- Ⓐ Connect this unit to the external device with USB Cable (supplied with the external media device)
- Ⓑ External media device (commercially-available)
- Ⓒ USB flash memory (commercially-available)

1 (When using USB HDD)

Connect the AC adaptor (supplied with USB HDD) to the USB HDD.

- If you are using a bus-powered or portable USB HDD, this unit can supply power to the USB HDD by USB Cable (supplied with USB HDD).

2 Connect the AC adaptor to this unit.

- Use the AC adaptor to free you from worrying about the battery running down.

3 Turn on the unit and set the mode switch to .

4 Connect the external media device to the USB terminal of this unit.

- If you use a USB HDD, connect to the USB HDD with the USB Cable supplied with the USB HDD.
- It may take several minutes until the connection is completed.

5 Touch the desired item.

[DIFFERENTIAL COPY]:	Copies all scenes and still pictures recorded with this unit that have not been copied yet. (→ 109)
[SELECT COPY]:	Allows you to select desired scenes/still pictures, and then copy. (→ 110)
[Playback from External Media]:	Plays back scenes and still pictures stored in an external media device on this unit. (→ 111)
[Safe Removal]:	Allows you to safely remove this unit and an external media device.

When the external media device is connected to other devices such as Blu-ray disc recorder, a message prompting to format the external media device may display. All the scenes and still pictures recorded on the external media device will be erased if formatted. Do not format as important data will get erased and it will be impossible to restore.

■ Points to check before copying

- When using an external media device for the first time, or using an external media device that has been used with other devices, first run **[FORMAT MEDIA]**.
- Before copying, go to **[MEDIA STATUS]** to check the amount of free space on the external media device. (→ 109)
- It may take longer to copy when there are many scenes.
- If you copy protected scenes or still pictures, the protection setting of the copied scenes or still pictures are canceled.
- The order in which the scenes were copied cannot be changed.

Before you delete the data on the SD card after copying is complete, be sure to play back the external media device to check that they have been copied to correctly. (→ 111)

■ Formatting

This is for initializing the external media device.

- Please be aware that if a media is formatted then all the data recorded on the media is erased and cannot be recovered. Back up important data on a PC etc.
- Connect this unit to the external media device and touch [Playback from External Media]. Select the menu.



- When formatting is complete, touch [EXIT] to exit the message screen.
- Connect this unit and the external media device to format.
You may no longer be able to use the external media device if you format them on another device such as a PC etc.
- This unit formats the external media device in exFAT.

■ Displaying media information

The used space of the external media device can be checked.

- Connect this unit to the external media device and touch [Playback from External Media]. Select the menu.

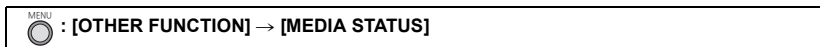

- If you touch [CHANGE MEDIA], you can switch the display between the SD card 1, SD card 2, and the external media device.

Differential copy

1 Connect this unit to the external media device to prepare for copying. (→ 107)

2 Touch [DIFFERENTIAL COPY].

- You can also access this function by selecting menu items.
[COPY] → [DIFFERENTIAL COPY]

3 Touch the media you want to copy.

4 Touch [YES].

5 Touch [EXIT] when the copy complete message is displayed.

- The thumbnail view of the copy destination is indicated.

When you stop copying halfway:

Touch [CANCEL] while copying.

Copy selected files



1 Connect this unit to the external media device to prepare for copying. (→ 107)

2 Touch [SELECT COPY].

- You can also access this function by selecting menu items.

[COPY] → [SELECT COPY]

3 Touch the media you want to copy.

[ → ]: When copying from the SD card 1 to the external media device.

[ → ]: When copying from the SD card 2 to the external media device.

- For information on copying between SD cards, refer to page 98.

4 Touch the desired items following the instructions on the screen.

- It will return to the previous step by touching [Return].
- (When [SELECT SCENES] is selected)
When touched, the scene/still picture is selected and the  indication appears on the thumbnail. Touch the scene/still picture again to cancel the operation.
- (When [SELECT DATE] is selected)
When touched, the date is selected and surrounded by red. Touch the date again to cancel the operation.
- Up to 99 scenes/99 dates can be selected continuously.

5 Touch [EXIT] when the copy complete message is displayed.

- The thumbnail view of the copy destination is indicated.

When you stop copying halfway:

Touch [CANCEL] while copying.

Playing back the External Media

- Only motion picture/still picture that have been copied by connecting this unit to the external media device can be played back.

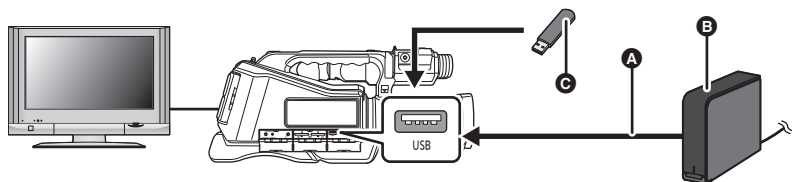

- **A** USB Cable (supplied with USB HDD)
- **B** USB HDD (commercially-available)
- **C** USB flash memory (commercially-available)

1 Connect this unit to the external media device to prepare for playback. (→ 107)

- When playing back on an external monitor, connect this unit to the external monitor. (→ 101)

2 Touch [Playback from External Media].

3 Touch the scene or still picture to be played back and then play it back.



- The playback operation is performed the same as when playing back motion pictures or still pictures. (→ 88, 92)

To terminate the connection between this unit and the external media device

Touch the play mode select icon (→ 88) and then touch .

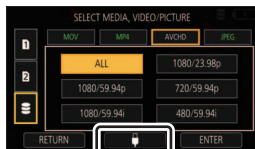
- Disconnect the USB Cable from this unit.





- It is also possible to switch the media to play back by touching the play mode select icon. When the external media device is connected, the  (external media device) can be selected from the displayed media types. (→ 88)
- Deleting scenes and still pictures on the external media device may take time.
- You cannot set the [SCENE PROTECT] during playback of  (external media device). (→ 97)

Dubbing with a Blu-ray disc recorder, video device, etc.

■ Check before dubbing

Check the equipment used for dubbing.

Equipment used for dubbing	Dubbing picture quality	To dub
Equipment with SD card slot	High-definition picture quality*	Insert the SD card directly 
Equipment without SD card slot or USB terminal	Standard picture quality This can be played back on equipment incompatible with high-definition (AVCHD), so it is convenient if you are dubbing for distribution.	Connect with the AV cable (commercially-available) (→ 113) 

- * Some equipment may not be compatible with high-definition (AVCHD) picture quality or MP4. In such a case, connect with the AV cable (commercially-available) and dub with standard picture quality. (→ 113)
- For the positions of the SD card slot, or terminal for connecting the AV cable, refer to the operating instructions of the equipment used.

You can dub scenes recorded with this unit to a Panasonic Blu-ray disc recorder or DVD recorder that supports their recording mode and recording format.

- **Note that the equipment described may not be available in certain countries and regions.**

Dubbing in high-definition picture quality

■ To dub using equipment with an SD card slot

You can dub by directly inserting an SD card.

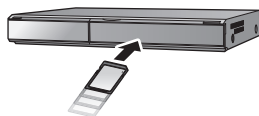

- For details on dubbing and playback methods, read the operating instructions of the Blu-ray disc recorder or DVD recorder.

Dubbing in standard picture quality

■ Dubbing using equipment without an SD card slot or using a video device

You can dub by connecting an AV cable (commercially-available).

- Use the AC adaptor to free you from worrying about the battery running down.

Change the video input on the video device and TV that this unit is connected to.

- The channel set will differ depending on the terminal to which the unit is connected. (See the operating instructions of the video device and TV for details.)

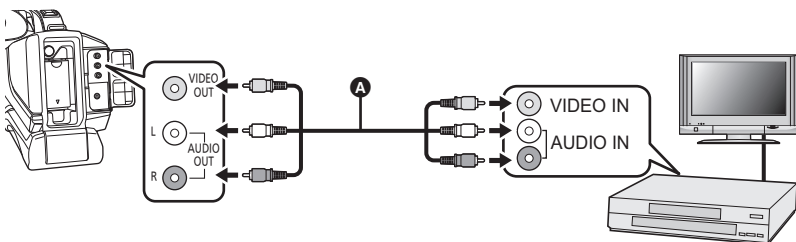

A AV cable (commercially-available)

- Insert the plugs as far as they will go.

- Set the mode switch to . (→ 28)

1 Connect this unit to a video device and start playback on this unit.

2 Start recording on the connected device.

- To stop recording (dubbing), stop playback on this unit after stopping recording on the recorder.

-
- To play back scenes that are not found in the recording format option [SA 480/59.94i], set [RESOLUTION] to [DOWN CONV.]. (→ 103)

- Some screens, such as the menu screen, may be displayed in reduced sizes on the TV.

- If the date and time display and function indication are not wanted, cancel them before dubbing. (→ 103, 133)

If the dubbed images are played back on a wide-screen TV, the images may be stretched vertically.

In this case, refer to the operating instruction for the device you are connecting to or read the operating instructions of the wide-screen TV and set the aspect ratio to 16:9.

Using the Menu

Refer to page 36 for how to set up the Menu.

Camera Setup



All default settings are indicated with underlined text.

 : **[CAMERA SETUP]** → **desired setting**

[PICTURE TONE]

Changes the contrast of the overall image.

[STANDARD]:	This mode is standard image setting.
[SHARP]:	This mode is high-contrast image setting for both color and luminance.

[SCENE MODE]

The shutter speed and aperture, etc. are automatically adjusted to match the scene you want to record.

- **Switch to Manual Mode. (→ 42)**
- 1 Touch [SCENE MODE].**
- 2 Touch the item you want to set.**



OFF:	Cancel the setting
Sports:	To make fast moving scenes less shaky with slow playback and pause of playback
Portrait:	To make people stand out against the background
Soft skin:	To makes skin colors appear softer for a more attractive appearance
Spotlight:	Improved quality when subject is brightly illuminated.
Snow:	Improved image quality when shooting in snowy locations.
Beach:	To make blue in the sea or sky vibrant
Sunset:	To make red in the sunrise or sunset vibrant
Scenery:	For spatial scenery
Fireworks:	To capture the fireworks in the night sky beautifully
Night scenery:	To capture the evening or night scenery beautifully

- 3 Touch [EXIT] to exit the menu screen.**

-
- This function is disabled during Super Slow Recording (→ 78)
 - **(Sunset/Scenery/Fireworks/Night Scenery)**
 - Image may get blurry when close object is recorded.
 - **(Sports)**
 - During normal playback, the image movement may not look smooth.
 - Color and screen brightness may change under indoor lighting.
 - If the brightness is insufficient, the Sports Mode does not function. The [Sports] display flashes.
 - **(Portrait)**
 - Color and screen brightness may change under indoor lighting.
 - **(Soft Skin)**
 - If the background or anything else in the scene has colors similar to the skin color, they will also be smoothed.
 - If the brightness is insufficient, the effect may not be clear.
 - If you record a person in the distance, the face may not be recorded clearly. In this case, cancel Soft Skin Mode or zoom in on the face (close-up) to record.
 - **(Fireworks)**
 - Image may get washed out when recorded in bright surrounding.
 - **(Night Scenery)**
 - Using a tripod is recommended.

[SHARPNESS]



Adjusts the degree of overall outline correction in images.

- **Switch to Manual Mode.** (→ 42)
- 1 Touch [SHARPNESS].
 - 2 Touch  /  to adjust settings.
- You can select a value between -5 and +5.
- 3 Touch [EXIT] to exit the menu screen.

-
- The default setting is 0.

[COLOR]

Adjusts color density.



- **Switch to Manual Mode.** (→ 42)
- 1 Touch [COLOR].
 - 2 Touch  /  to adjust settings.
- You can select a value between -5 and +5.
- 3 Touch [EXIT] to exit the menu screen.

-
- The default setting is 0.

[EXPOSURE]

Adjusts color balance.



- **Switch to Manual Mode.** (→ 42)

- 1 Touch [EXPOSURE].
- 2 Touch  /  to adjust settings.
- You can select a value between -10 and +10.
- 3 Touch [EXIT] to exit the menu screen.

- The default setting is 0.
- [EXPOSURE] is not available when [SCENE MODE] is set to [Fireworks]. (→ 114)

[AWB Ach ADJUST]



Finely adjusts color temperature after Ach Auto White Balance adjustment.

- **Switch to Manual Mode.** (→ 42)
- 1 Touch [AWB Ach ADJUST].
 - 2 Touch  /  to adjust settings of color.
 - You can select a value between -5 and +5.
 - 3 Touch [EXIT] to exit the menu screen.

- The default setting is 0.

[AWB Bch ADJUST]

Finely adjusts color temperature after Bch Auto White Balance adjustment.

- **Switch to Manual Mode.** (→ 42)
- 1 Touch [AWB Bch ADJUST].
 - 2 Touch  /  to adjust settings of color.
 - You can select a value between -5 and +5.
 - 3 Touch [EXIT] to exit the menu screen.

- The default setting is 0.

[BACKLIGHT COMPENS.]

Switches to automatic iris control to compensate the backlight.

This makes the image brighter to prevent darkening of a backlit subject. (→ 54)

[ON]/[OFF]

[DRS]

Selects the DRS (Dynamic Range Stretcher) function. (→ 72)

- **Switch to Manual Mode.** (→ 42)

[ON]/[OFF]

[LEVEL SHOT]

This function detects the horizontal tilt of the unit, and automatically corrects it to the level position. (→ 75)

[ON]/[OFF]

[FLASH BAND COMPENSATION]

If you set this item to [ON], you can compensate for and reduce flash band, a phenomenon that creates markedly different levels of luminance between the top and bottom of the image when recording is performed in an environment where another camera is firing its flash. (→ 76)

- **Switch to Manual Mode.** (→ 42)

[ON]/[OFF]

[NR CONTROL]

You can control the noise reduction effect and afterimage intensity by adjusting the noise reduction setting.

1 Touch [NR CONTROL].

2 Touch / to adjust settings.

- You can select a value between -5 and +5.
- Adjusting the setting in the minus (-) direction weakens the noise reduction effect, thereby reducing afterimages. Note that this also tends to increase noise.
- Adjusting the setting in the plus (+) direction enhances the noise reduction effect, thereby reducing noise. Note that this may also cause afterimages to appear more frequently.

3 Touch [EXIT] to exit the menu screen.

- The default setting is 0.

System mode



All default settings are indicated with underlined text.



: [SYSTEM MODE] → desired setting

[REC MODE]

Switch the recording mode of the motion pictures to record.

[MP4]*:	This recording method is suitable for editing images. Motion pictures will be saved in MP4 format.
[MOV]*:	This recording method is suitable for editing images. Motion pictures will be saved in MOV format.
[AVCHD]:	This recording method is suitable for playback on a high-definition compatible TV.

* It is not compatible with motion pictures recorded in AVCHD.

- This item cannot be set during Freeze Frame. (→ 72)

[REC FORMAT]

Switch the picture quality of motion pictures to be recorded with this unit.
Depending on the settings of [REC MODE], the available [REC FORMAT] settings differ.

How to read a [REC FORMAT] setting

Items that make up a [REC FORMAT] setting represent Size, Vertical resolution, Frame rate, and Bit rate. (Excluding the [REC FORMAT] settings that are available when [REC MODE] is set to [AVCHD])

FHD 1080 / 59.94p 50M

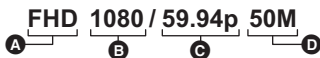

A Size

B Vertical resolution

C Frame rate

D Bit rate

- Smoother motion picture can be recorded with the higher value for the frame rate. [i] and [p] of the frame rate means interlace and progressive respectively.

Interlace (interlacing scanning)

Video signal that divides the effective scanning lines to half and send them alternatively

Progressive (progressive scanning)

High density video signal sending the effective scanning lines simultaneously (It will be higher quality image than the interlace.)

- The higher the bit rate value is, the higher the picture quality becomes.
- It can record with highest quality image in this unit when set to [FHD 1080/59.94p 50M].
- Depending on the [REC MODE] setting and the bit rate of the [REC FORMAT] setting, its required Speed Class of the SD card differs. Use an SD card that meets the settings. For details, refer to "About the Speed Class ratings for recording motion pictures" on page 26.

- When [MOV] or [MP4] in [REC MODE] is selected

Recording format	Size (Picture size)	Frame rate	Bit rate (VBR)
[FHD 1080/59.94p 50M]	FHD (1920×1080)	59.94p	Average 50 Mbps
[FHD 1080/29.97p 50M]		29.97p	
[FHD 1080/23.98p 50M]		23.98p	
[FHD 1080/59.94i 50M]		59.94i	

● When [AVCHD] in [REC MODE] is selected

Recording format	Picture size	Frame rate	Bit rate (VBR)
[PS 1080/59.94p]	1920×1080	59.94p	Average 25 Mbps
[PH 1080/59.94i]		59.94i	
[PH 1080/23.98p]		23.98p	Average 21 Mbps
[HA 1080/59.94i]		59.94i	
[HE 1080/59.94i]	1440×1080		Average 5 Mbps
[PM 720/59.94p]	1280×720	59.94p	Average 8 Mbps
[SA 480/59.94i]	720×480	59.94i	Average 9 Mbps

● **Recordable time using the battery (→ 25)**

- The default setting for [REC MODE] is [AVCHD], and the default setting for [REC FORMAT] is [PH 1080/59.94i].
- This item cannot be set during Freeze Frame. (→ 72)
- Please refer to page 155 about approximate recordable time.
- When the unit is moved a lot or moved quickly, or when a fast-moving subject is recorded, mosaic-type noise may appear at playback. (Only when recording AVCHD scenes)

About recording formats and recording functions

The relationship between recording formats and recording functions of this unit are shown below.

- “○”: Available; “—”: Not available*

* “Not available” includes instances where the desired function cannot be used or selected.

Recording format	Recording function				
	Normal recording	Interval Rec (→ 127)	Super Slow Recording (→ 78, 128)	Relay recording (→ 126)	Simultaneous recording (→ 126)
[FHD 1080/59.94p 50M]	○	—	○	○	○
[FHD 1080/29.97p 50M]	○	○	○	○	○
[FHD 1080/23.98p 50M]	○	—	○	○	○
[FHD 1080/59.94i 50M]	○	—	—	○	○
[PS 1080/59.94p]	○	—	—	○	○
[PH 1080/59.94i]	○	—	—	○	○
[PH 1080/23.98p]	○	—	—	○	○
[HA 1080/59.94i]	○	○	—	○	○
[HE 1080/59.94i]	○	—	—	○	○
[PM 720/59.94p]	○	—	—	○	○
[SA 480/59.94i]	○	—	—	○	○

[ASPECT CONVERT]

This sets the aspect ratio of images to be recorded with a [REC FORMAT] setting of [SA 480/59.94i].

- Set [REC FORMAT] to [SA 480/59.94i]. (→ 118)

[SIDE CROP]:	Records images in standard 4:3 mode. The sides will be cut off.
[SQUEEZE]:	Records images by compressing images in the horizontal direction. When recorded images are played back on a wide-screen TV, they appear in the 16:9 aspect ratio.

- This function is not available in the following cases:
 - When [REC FORMAT] is set to an option other than [SA 480/59.94i] (→ 118)
 - During Freeze Frame (→ 72)

[CAMERA NUMBER SET]

This sets the camera number for this unit.

1 Touch [CAMERA NUMBER SET].

2 Touch  /  to change the Camera Number.

- Numbers between 0 and 16 can be set.

3 Touch [RETURN].

- Touch [EXIT] to exit the menu screen.

- This function's default setting is "0".

User switch

All default settings are indicated with underlined text.

 : [USER SW] → desired setting

[USER1]/[USER2]/[USER3]



Sets the function to assign to the USER buttons. (→ 66)

- For the functions of the USER button that can be registered, refer to page 67.

- The default settings are as follows:

- USER1: <PUSH AF>
- USER2: <WHITE BAL>
- USER3: <FOCUS ASSIST 1>

[USER4]/[USER5]/[USER6]/[USER7]



Register functions to USER button icons. (→ 66)

- For the functions of the USER button that can be registered, refer to page 67.

- The default settings are as follows:

- USER4: <FRZ FRAME>
- USER5: <DRS>
- USER6: <LEVEL GAUGE>
- USER7: <MENU>

[USER BUTTON DISPLAY]



Switches the display of the set USER button icons. (→ 67)

[ON]/[OFF]

Switch setting



All default settings are indicated with underlined text.

 : [SW SETUP] → desired setting

[IRIS RING]

Sets the rotational direction and aperture control of the multi-manual ring for iris adjustment.

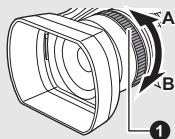

[DOWN OPEN]: Iris will open when it is turned toward B.

[UP OPEN]: Iris will open when it is turned toward A.

1 Multi-manual ring

[SUPER GAIN]

Sets the gain value for the USER button function <SUPER GAIN>. (→ 55)

• **Switch to Manual Mode.** (→ 42)

[33 dB]/[36 dB]

[AGC LIMIT]

Sets the maximum possible gain value for Auto Gain Mode. (→ 55)

• **Switch to Manual Mode.** (→ 42)

[3 dB]/[6 dB]/[9 dB]/[12 dB]/[15 dB]/[18 dB]/[21 dB]/[24 dB]/[27 dB]/[30 dB]

[HYBRID O.I.S.]

You can set the Hybrid Optical Image Stabilizer. (→ 83)

[ON]/[OFF]

[SLOW SHUTTER]

You can record bright pictures even in dark places by slowing the shutter speed.

Slow Shutter works in Auto Shutter Mode. (→ 59)

[ON]/[OFF]

- The shutter speed will be adjusted to one of the following values according to the ambient brightness. The value will differ depending on the frame rate of the [REC FORMAT].

Frame rates	Shutter speed
59.94p/59.94i/29.97p	1/30 or more
23.98p	1/24 or more

- This function is not available in the following cases:
 - When a setting in [SCENE MODE] is enabled (→ 114)
 - During Super Slow Recording (→ 78)
 - During Freeze Frame (→ 72)
- When the shutter speed becomes 1/30 or 1/24, the screen may be seen as if frames are missed and after images may appear.

[FOCUS ASSIST 1]

Sets the Focus Assist method for the FOCUS ASSIST button and the USER button to which <FOCUS ASSIST 1> is registered. (→ 49)

[EXPAND]/[PEAKING]/[BOTH]

[FOCUS ASSIST 2]

Sets the Focus Assist method for the USER button to which <FOCUS ASSIST 2> is registered. (→ 49)

This item is not available when [FOCUS ASSIST 1] is set to [BOTH].

- Set [FOCUS ASSIST 1] to [EXPAND] or [PEAKING]

[EXPAND]/[PEAKING]

[PEAKING COLOR]

You can set the peaking color for Focus Assist. (→ 51)

[Red]/[Blue]/[Yellow]/[White]

[PEAKING LEVEL]

You can set the peaking strength for Focus Assist. (→ 51)

- This function's default setting is "0".

[AREA MODE]

You can set an Area Mode effect. (→ 73)

[INH]/[FOCUS]/[IRIS]/[Y GET]/[FOCUS/IRIS]/[FOCUS/Y GET]

[ZEBRA MODE]

This sets the display duration of the zebra display.

[CONTINUE]: Displays the zebra display until it is switched to another zebra display setting.

[MOMENT]: Displays the zebra display for approximately 5 seconds.

[BARS TYPE]

You can switch the type of color bars to be displayed when you press the BARS button. (→ 83)

[TYPE 1]	[TYPE 2]	[TYPE 3]
		

[SUB REC BUTTON]

Enable/disable of the sub recording start/stop button on the handle can be switched.

[INHIBIT]/[ACTIVE]

[SUB ZOOM]

Enable/disable of the sub zoom lever on the handle can be switched. Zoom speed will be different depending on the setting.

[OFF]/[1]/[2]/[3]/[4]/[5]/[6]/[7]

- The larger the value is, the faster the zoom speed becomes, and vice versa.

[DIGITAL ZOOM]

Changes the zoom magnification setting of Digital Zoom. (→ 70)

[×2]/[×5]/[×10]/[TOGGLE]

[i.Zoom]

You can zoom in while maintaining the beauty of high-definition picture quality up to a magnification of 40×.

[ON]/[OFF]

- This function is not available in the following cases:
 - During Super Slow Recording (→ 78)
 - During Freeze Frame (→ 72)

Recording Setup



All default settings are indicated with underlined text.



: [RECORD SETUP] → **desired setting**

[MEDIA SELECT]

[SD CARD 1] and [SD CARD 2] can be selected separately to record motion pictures or still pictures. (→ 37)

[2 SLOTS FUNC.]

You can set relay/simultaneous recording.

- **Insert SD cards to card slot 1 and card slot 2.**

[OFF]:	Cancel the setting.
[RELAY REC] ^{*1} :	Set the relay recording
[SIMULTANEOUS] ^{*2} :	Set the simultaneous recording

*1 This function is not available in the following cases:

- During Super Slow Recording (→ 78)
- During the Interval Recording (→ 127)

*2 This item is not available when different types of SD cards (SDHC Memory Card/SDXC Memory Card) are used.

■ Relay recording

This is simple Relay Recording. It is possible to continuously record on the SD card in the other card slot even when the available capacity of the SD card runs out during the recording.

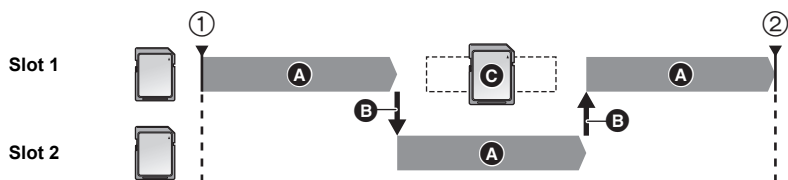

- ① Recording is started
- ② Recording is paused
- A Recording
- B The card slot used for recording is switched automatically.
- C Replace the SD card with a recordable one.

- [RELAY] is displayed beside the display of the SD card selected as the recording destination of motion pictures in [MEDIA SELECT] (→ 37). When the recording media is switched and Relay Recording starts, [RELAY] will disappear from the location and instead be displayed beside the other SD card display.
- Even after switching of the recording media, you can replace the SD card that ran out of space with a new one and record the motion picture onto three or more SD cards. Since it may take a while for this unit to recognize a new SD card, replace the SD card that ran out of space when the SD card currently being used as a destination still has sufficient remaining recordable time.
- The maximum recording time for Relay Recording is 10 hours.
- When the recording time of Relay Recording reaches 10 hours, the recording will stop temporarily. It will restart automatically a few seconds later.

■ Simultaneous recording

Same motion picture can be recorded on two SD cards.



- ① Recording is started
- ② Recording is paused
- A Recording

- [SIMUL] is displayed beside the display of the SD card selected as the recording destination of motion pictures in [MEDIA SELECT] (→ 37).
- If you set the recording destination of motion pictures to [SD CARD 1] in [MEDIA SELECT], they will also be recorded to [SD CARD 2] simultaneously.
- We recommend that you perform simultaneous recording using SD cards of the same Speed Class rating and capacity.

(Relay recording)

- Destination to record still pictures will be switched to other SD card after performing the relay recording. In addition, a message about the remaining card capacity will be displayed. Replace the SD card that ran out of space or set [2 SLOTS FUNC.] to [OFF].

(Simultaneous recording)

- Simultaneous recording will not be performed for still pictures.
- When performing simultaneous recording, even in the case where an error has occurred in one of the SD cards and recording has stopped, recording can be continued using the other SD card.
- When one of the media reaches its maximum recording time, the simultaneous recording stops.

[INTERVAL REC]

A scene that moves slowly for long period of time is recorded frame by frame with an interval, and is recorded as a short time motion picture.

One frame is recorded every recording interval that is set.

- 30 frames make up a scene of 1 second.
- Set [REC FORMAT] to [FHD 1080/29.97p 50M] or [HA 1080/59.94i].

[OFF]/[1 SEC.]/[10 SEC.]/[30 SEC.]/[1 MINUTE]/[2 MINUTES]

- [-] is displayed on the screen. The icon changes to [-REC] after recording starts.
- After recording, the setting of Interval Recording is canceled.
- Audio cannot be recorded.

Setup example	Setup time (recording interval)	Recording time	Recorded time
Sunset	1 s	1 h	2 min
Blooming	30 s	3 h	12 s

- "h" is an abbreviation for hour, "min" for minute and "s" for second.
- These times are approximations.
- Maximum recordable time is 168 hours.

-
- Still picture recording cannot be used.
 - This function is not available in the following cases:
 - During Freeze Frame (→ 72)
 - PRE-REC is used (→ 77, 128)
 - During Super Slow Recording (→ 78)
 - [INTERVAL REC] is canceled in the following cases.
 - If you turn the unit off
 - When the mode switch position is changed
 - If you set [REC FORMAT] to a setting other than [FHD 1080/29.97p 50M] and [HA 1080/59.94i].
 - The shortest motion picture recording time is approx. 2 second.
 - Color balance and focus may not be adjusted automatically depending on light sources or scenes. If so, manually adjust these settings. (→ 47, 56)
 - We recommend connecting the AC adaptor to this unit when recording images for a long period of time.

[SUPER SLOW REC]

This enables/disables Super Slow Recording.

- **Switch to Manual Mode.** (→ 42)

[ON]/[OFF]

[PRE-REC]

This allows the recording of an image and audio to start before you press the recording start/stop button. AVCHD scenes will be recorded from approximately 3 seconds before the operation, while MOV/MP4 will be recorded from approximately 4 seconds before the operation. (→ 77)

[ON]/[OFF]

[DF MODE]

Selects the compensation mode for the time code. (→ 64)

[DF]/[NDF]

[TCG]

Sets the way the time code will move. (→ 64)

[FREE RUN]/[REC RUN]

[TC PRESET]

Initial value of the time code can be set. (→ 64)

Audio Setup



All default settings are indicated with underlined text.

MENU



: [AUDIO SETUP] → desired setting

[AUDIO LOW CUT]

Reduces the level of low-pitched sound.

[ON]/[OFF]

- This is displayed only when an external microphone is connected.
- You may not see the full effect depending on the recording conditions.

[AUDIO LEVEL]

Switches the adjustment method of the audio recording level. (→ 61)

[AUTO]/[MANUAL]

[AUDIO ALC]

If you set this item to [ON], you can reduce the audio noise.
It will record with natural sound when set to [OFF]. (→ 62)

[ON]/[OFF]

Output Setup

Different menu items are displayed depending on whether this unit is in Recording Mode or Playback Mode.

All default settings are indicated with underlined text.

MENU



: [OUTPUT SETUP] → desired setting

[RESOLUTION]



This changes the way in which images are output to an external device. (→ 103)

[SYSTEM]/[1080p]/[1080i]/[DOWN CONV.]

[DOWN CONV.]



This function allows you to select how to display images with a 16:9 aspect ratio on a TV with a 4:3 aspect ratio. (→ 102)

- Set [RESOLUTION] to [DOWN CONV.]. (→ 103)

[SIDE CROP]/[LETTERBOX]/[SQUEEZE]

[REMOTE REC]



This enables/disables a function that controls recording performed with an external device connected to the unit.

[ON]/[OFF]

[REMOTE REC LINK]



When [ON] is selected, you can control recording performed with this unit and an external device using the recording start/stop button.

[ON]: Controls recording performed with this unit and an external device using the recording start/stop button.

[OFF]: Controls recording performed with an external device using the USER button function <AUTO REC>. (→ 80)

[HDMI TC OUTPUT]



Switches the output setting of time code information when this unit is connected to another device (HDMI-SDI converter, etc.) with an HDMI cable.

- When performing remote recording with the <AUTO REC> USER button function, select [ON].
(→ 80)
- (In Playback Mode)
Touch the play mode select icon, and set this unit to Motion Picture Playback Mode. (→ 88)

[ON]/[OFF]

[H/PHONE MODE]



Select the sound heard through the headphone terminal and AUDIO OUT terminal.

[LIVE]:	The sound which has been input from the microphone is output as is. This setting is selected when delays in the sound are annoying.
[RECORDING]:	The sound in the status which is to be recorded (the sound synchronized with the images) is output.

- When an HDMI cable is connected to this unit, even if you select [LIVE], sound will be output according to [RECORDING].

[VOLUME]



When [ON] is selected, you can adjust the headphone volume in Recording Mode. (→ 87)

[ON]/[OFF]

[TEST TONE]



Selects the test tone output when color bars are displayed. (→ 83)

[OFF]:	Does not output a test tone.
[LEVEL 1]:	Outputs a high volume test tone.
[LEVEL 2]:	Outputs a low volume test tone.

[LCD/EVF OUTPUT]



This sets how to turn on/off the LCD monitor and viewfinder. (→ 29)

[LCD]/[EVF]

Display setting

Different menu items are displayed depending on whether this unit is in Recording Mode or Playback Mode.

All default settings are indicated with underlined text.

 : [DISP SETUP] → desired setting

[ZEBRA DETECT 1]



Selects the brightness level of the left-leaning zebra patterns on the screen.

1 Touch [ZEBRA DETECT 1].

- Touch [YES].

2 Touch / to adjust settings.

- You can select a value between 50% and 105%.

3 Touch [EXIT] to complete the setting.

- This function's default setting is "80%".

[ZEBRA DETECT 2]



Selects the brightness level of the right-leaning zebra patterns on the screen.

[SET] / [OFF]

1 Touch [ZEBRA DETECT 2].

- Touch [SET].

2 Touch / to adjust settings.

- You can select a value between 50% and 105%.

3 Touch [EXIT] to complete the setting.

- You can display [ZEBRA 2] after setting the level. (→ 84)

- This function's default setting is "100%".

[MARKER]



Displaying of the luminance level display marker can be switched.

[ON] / [OFF]

- Marker can be displayed when set to [ON]. (→ 84)

[GUIDE LINES]



You can check if the image is level while recording motion pictures and still pictures. The function can also be used to estimate the balance of the composition.

[≡]/[⊕]/[⊞]/[OFF]

- The guidelines do not appear on the images actually recorded.
- The setting changes as follows when using Focus Assist. (→ 49)
 - The guidelines are not displayed. (They are displayed on the TV when this unit is connected to the TV.)
 - The setting cannot be changed.

[SAFETY ZONE]



Display of the range that can be displayed with the external monitor (safety zone **A**) can be switched.

(When [16:9 90%] is set)

Aspect ratio	[SAFETY ZONE]
16:9	[16:9 90%]/[4:3]/[14:9]/[1.85:1]/[2:1]/ [2.35:1]/[2.39:1]/[OFF]
4:3*	[4:3 90%]/[4:3]/[OFF]



* When [REC FORMAT] is set to [SA 480/59.94i] and [ASPECT CONVERT] is set to [SIDE CROP] (→ 118, 120)

- The safety zone is not displayed on the images that is actually recorded.

[CENTER MARKER]



Displays/hides the center marker.

[ON]/[OFF]

[REC COUNTER]



Selects the operation of the Recording Counter during recording. (→ 65)

[TOTAL]/[SCENE]

[VIDEO OUT OSD]



The information displayed on the screen (operation icon and counter display etc.) can be displayed/not displayed on the TV. (→ 103)

[ON]/[OFF]

[DATE/TIME]



It is possible to change the date and time display mode.

[OFF]/[TIME]/[DATE]/[DATE&TIME]

[DATE FORMAT]



It is possible to change the date format.

[Y/M/D]/[M/D/Y]/[D/M/Y]

[LEVEL GAUGE]



This function displays the horizontal/vertical tilt of the unit with the electronic level. (→ 75)

[ON]/[OFF]

[HISTOGRAM]



A graph with brightness as horizontal axis and number of pixels at that brightness as vertical axis is displayed. It is possible to determine the exposure of the whole image by looking at the distribution in the graph. (→ 71)

[ON]/[OFF]

[AUDIO LEVEL METER]



Select to display the audio level meter.

- (In Playback Mode)

Touch the play mode select icon, and set this unit to Motion Picture Playback Mode. (→ 88)

[ON]/[OFF]

[LENS STATUS]



Display relating to lens can be switched. (Zoom Display, Optical Image Stabilizer, Focus Display, White Balance, Iris, Gain, Auto Iris, Shutter Speed, Level Shot, Built-in LED light)

[ON]/[OFF]

[CARD & BATTERY]



Display can be switched between the remaining recordable time of the SD card and the remaining battery capacity indication.

[ON]/[OFF]

[OTHER DISPLAY]



This shows or hides indications on the screen except for [USER BUTTON DISPLAY], [GUIDE LINES], [SAFETY ZONE], [CENTER MARKER], [DATE/TIME], [AUDIO LEVEL METER], [LENS STATUS] and [CARD & BATTERY].

[ON]/[OFF]

[POWER LCD]



This makes it easier to view the LCD monitor in bright places including outdoors. (→ 31)

[+1]/[0]/[-1]

[LCD SET]



It adjusts brightness and color density on the LCD monitor. (→ 31)

[COLOR]/[BRIGHTNESS]/[CONTRAST]

- The default settings are as follows:
 - [COLOR]: “0”
 - [BRIGHTNESS]: “0”
 - [CONTRAST]: “0”

[EVF SET]



Brightness of the viewfinder can be switched. (→ 32)

[BRIGHT]/[NORMAL]/[DARK]

[SELF SHOOT]



Switches the mirror function of the LCD monitor when recording yourself. (→ 33)
The image on the LCD monitor is displayed mirrored horizontally during recording of yourself when it is set to [MIRROR].

[MIRROR]/[NORMAL]

[EVF COLOR]



The recording images or playback images on the viewfinder can be selected between color/black and white. (→ 32)

[ON]/[OFF]

[EVF/LCD DETAIL]



Setting this item to [ON] helps you achieve focus easier by emphasizing the outlines of an image displayed on the LCD monitor and viewfinder. (→ 48)

[ON]/[OFF]

[EVF/LCD PEAK LEVEL]



Adjusts the emphasis strength for [EVF/LCD DETAIL]. (→ 48)

- This function's default setting is "0".

[EVF/LCD PEAK FREQ.]



Sets the peaking frequency for [EVF/LCD DETAIL]. (→ 48)

[HIGH]/[LOW]

Other Functions

Different menu items are displayed depending on whether this unit is in Recording Mode or Playback Mode.

All default settings are indicated with underlined text.

 : [OTHER FUNCTION] → desired setting

[FORMAT MEDIA]



The SD card or the external media device can be formatted. (→ 38, 109)

- Please be aware that if a medium is formatted, then all the data recorded on the medium will be erased and cannot be restored. Back up important data on a PC etc. (→ 105)

[MEDIA STATUS]



The used space and remaining recordable time of the SD card can be checked.

- Touching [CHANGE MEDIA] switches the unit between the display for the SD card 1 and the display for the SD card 2.
 - Only in Recording Mode, remaining recordable time for the selected recording format is displayed.
 - Touch [EXIT] to close the indication.
-
- The SD card requires some space to store information and manage system files, so the actual usable space is slightly less than the indicated value. The usable space is generally calculated as 1 GB=1,000,000,000 bytes. The capacities of this unit, PCs and software are expressed as 1 GB=1,024×1,024×1,024=1,073,741,824 bytes. Therefore, the indicated value of the capacity appears to be smaller.

[REC LAMP]



The recording lamp lights up during recording. When this is set to [OFF], it does not light during recording.

[ON]/[OFF]

[CLOCK SET]



Set date and time. (→ 34)

[TIME ZONE]



Set the time difference from Greenwich Mean Time. (→ 34)

[RING LED (BLUE)]



The ring LED lights up blue in Recording Mode.

[ON]/[5 SEC.]/[OFF]

- When [5 SEC.] is set, the ring LED lights up for 5 seconds after the unit is turned on or the Recording Mode is switched.
- When [RING LED (RED)] is set to [ON], the ring LED lights up red during recording.

[RING LED (RED)]



The ring LED lights up red during recording.

[ON]/[OFF]

- When the [REC LAMP] is set to [OFF], this item cannot be set.

[QUICK POWER ON]



The unit is put into recording pause approx. 1 second when the unit is turned on.

[ON]/[OFF]

- Depending on the recording conditions, start time may be longer than 1 second.
- In the Quick Power On Mode, the zoom magnification becomes approx. 1×.

[ALERT SOUND]



Touch screen operation, start and stop of recording can be confirmed with this sound.
When [OFF] is selected, the sound is not output at the start/end of recording, etc.

[OFF] / (Volume low) / (Volume high)

2 Beeps for 4 times

When an error occurs. Check the message displayed on the screen. (→ 145)

[ECONOMY (BATT)]



When about 5 minutes have passed without any operation, this unit automatically turns off to save battery life.

[ON]/[OFF]

- This unit will not automatically turn off even if the [ECONOMY (BATT)] is set to [ON] in following cases:
 - PRE-REC is used (→ 77, 128)

[ECONOMY (AC)]



When connected to AC adaptor about 15 minutes have passed without any operation, this unit automatically turns off.

[ON]/[OFF]

- This unit will not automatically turn off even if the [ECONOMY (AC)] is set to [ON] in following cases:
 - PRE-REC is used (→ 77, 128)

[INITIAL SET]



The menu settings is reset to the default.

[YES]: This is for initializing all menus.*

[NO]: This is for not performing initialization.

* Settings for [CLOCK SET] and [TIME ZONE] will not be changed.

- Returning all settings to the default is not possible during Freeze Frame. (→ 72)

[NUMBER RESET]



Set the file number of the MOV/MP4 and still picture recorded next to 0001.

- Folder number is updated and file number will start from 0001. (→ 105)
- To reset the folder number, format the SD card, and then perform [NUMBER RESET].

[LANGUAGE]



You can select the language on the screen display and the menu screen.

Maintenance



MENU



: [MAINTENANCE] → desired setting

[VERSION]

The version of the firmware of this unit is displayed.

[UPDATE]

The firmware of this unit is updated.

For the latest update information, check the support website below.

(As of March 2018)

http://panasonic.jp/support/global/cs/e_cam

(This Site is English only)

[HOUR METER]

This displays the operation time of this unit, how many times the zoom lever has been operated, how many times the zoom motor has worked and how many times the jog dial has been pressed.

Video Setup



All default settings are indicated with underlined text.

- Set the mode switch to  . (→ 28)
- Touch the play mode select icon, and set this unit to Motion Picture Playback Mode. (→ 88)

MENU



: [VIDEO SETUP] → desired setting

[REPEAT PLAY]

Playback of the first scene starts after playback of the last scene finishes when set to [ON]. (→ 94)

[ON]/[OFF]

[RESUME PLAY]

If playback of a scene was stopped halfway, the playback can be resumed from where it was stopped when set to [ON]. (→ 94)

[ON]/[OFF]

[SCENE PROTECT]

Scenes can be protected so that they are not deleted by mistake.

(Even if you protect some scenes, formatting the SD card will delete them.) (→ 97)

[DELETE]

Deletes a scene. (→ 96)

Picture Setup



- Set the mode switch to . (→ 28)
- Touch the play mode select icon, and set this unit to Still Picture Playback Mode. (→ 88)



: [PICT. SETUP] → desired setting

[SCENE PROTECT]

Still pictures can be protected so that they are not deleted by mistake.

(Even if you protect some still pictures, formatting the SD card will delete them.) (→ 97)

[DELETE]

Deletes a still picture. (→ 96)

Copy



- Set the mode switch to . (→ 28)



: [COPY] → desired setting

[DIFFERENTIAL COPY]

This copies all scenes and still pictures recorded with this unit that have never been copied to another device to the external media device connected to this unit. (→ 109)

[SELECT COPY]

This allows you to select and copy the scenes/still pictures. You can copy between the SD cards in this unit or from either of them to the external media device. (→ 98, 110)

[1 → 2]/[2 → 1]/[1 →]/[2 →]

Indications

■ Recording indications

Example: Display in English

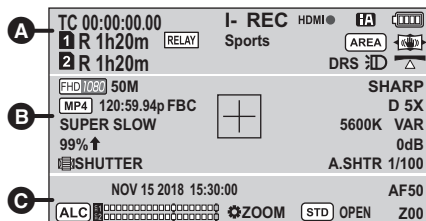

A	TC 00:00:00.00, TC 00:00:00:00 Counter display (→ 63)
I-	Interval Recording (→ 127)
I-REC (Red)	Interval Recording (Recording)
P-	PRE-REC (→ 77, 128)
P-REC (Red)	PRE-REC (Recording)
REC (Red)	Recording
REC (Flashing red)	Recording pause
HDMI ●, HDMI II	Automatic recording (→ 80)
fA	Intelligent Auto (→ 42)
	Remaining battery power (→ 25)
	Battery charging icon (→ 25)
1, 2 (White)	Recording to card possible (motion picture)
1, 2 (Green)	Card is being recognized (motion picture)
R 1h20m	Remaining time for motion picture recording (→ 39)
MAIN	Card slot selected for motion picture recording (during normal recording) (→ 37, 39)
RELAY	Relay recording (→ 126)

SIMUL Simultaneous recording (→ 126)

Sports, Portrait, Soft skin, Spotlight, Snow, Beach, Sunset, Scenery, Fireworks, Night scenery
SCENE MODE (→ 114)

AREA Area Mode (→ 73)

Freeze Freeze Frame (→ 72)

Image Stabilizer (→ 83)

DRS DRS (→ 72, 116)

Built-in LED light (→ 45)

Level shot (→ 75, 117)

B
FHD 1080, PS 1080, PH 1080, HA 1080, HE 1080, PM 720, SA

Recording format (→ 118)

50M Bit rate (→ 118)

SHARP, STANDARD
Picture tone (→ 80, 114)

MOV, MP4 Recording mode (→ 117)

120:59.94p
Frame rate during Super Slow Recording (→ 78, 128)

59.94p, 59.94i, 29.97p, 23.98p
Frame rate (→ 118)

FBC Flash band compensation (→ 76, 117)

D 2X, D 5X, D10X Digital Zoom (→ 70)

SUPER SLOW

Super Slow Recording (→ 78, 128)

5600K Color temperature display (→ 56)

ATW, LOCK, P3200K, P5600K, VAR, Ach, Bch

White Balance (→ 56)

99% ↑ Luminance level (→ 73, 84)



Luminance display frame (→ 84)



Center Marker (→ 132)

AGC, 0dB Gain value (→ 54)

SHUTTER Jog Dial Function (→ 86)

A.SHTR Auto Shutter display (→ 59)

1/100 Shutter speed (→ 59)



NOV 15 2018 15:30:00

Date indication

Time indication (→ 34)

AF50, MF50, AF 00, MF 00

Focus (→ 47)



When [AUDIO ALC] is enabled (→ 62)



When [AUDIO ALC] is enabled and audio cannot be recorded. (→ 78)



Audio level meter

(White): -12 dB

(Red): 0 dB



Sound recording disabled (→ 78)



ZOOM Manual ring setting (→ 46)



Auto iris mode (→ 53)



Backlight Compensation (→ 69)

OPEN, F2.0 Iris value (→ 53)

Z00, iZ00 Zoom magnification (→ 44)

iZ99 i.Zoom (→ 44)

1, 2 (White) Card recording possible status (still picture)

2.1M, 0.9M, 0.3M, 0.2M

Number of recording pixels for still pictures (→ 41, 93)

In Playback Mode, the picture size is not displayed for still pictures recorded with other products that have different picture sizes from the sizes shown above.

R3000 Remaining number of still pictures (→ 41)



(Red) Recording still picture

■ Playback indications

Example: Display in English

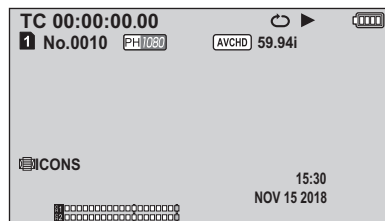

▶, ||, ►►, ►►►, ◀◀, ◀◀◀, ▶, ◀, ►►, ◀◀◀, ▶, ◀, ||►, ◀◀

Display during playback (→ 88, 92)

TC 00:00:00.00, TC 00:00:00:00

Counter Display (→ 63)

15:30 Time indication (→ 34)

NOV 15 2018 Date indication (→ 34)

No.0010 Scene Number



Repeat Playback (→ 94)



Resume Playback (→ 94)

100-0001 Still picture folder/file name



Protected motion pictures/still pictures (→ 97)

MOV, MP4, AVCHD

Recording mode (When thumbnails are displayed) (→ 88)

FHD, PS, PH, HA, HE, PM, SA

Recording format (When thumbnails are displayed) (→ 88, 118)

10 Scene Number (In 9-scene display in thumbnail mode)
(→ 88)

■ Indication of connection to the external media device

 Playback of the external media device (→ 111)

■ Confirmatory indications

-- (Time display) The built-in battery is low. (→ 34)

 Warning for recording of yourself (→ 33)

 SD card is not inserted.

 SD card is write-protected.

 SD card is non-compatible.

 SD card is full.

 Playback-only SD card

Messages

Major confirmation/error messages to be indicated on the screen in text.

During recording/playback

Display	Description	Behavior and cause
CHECK CARD.	The SD card is not supported by this unit.	<ul style="list-style-type: none"> • Check the SD card.
THIS CARD CANNOT RECORD IN VIDEO MODE.	This is displayed when the SD card has a capacity of less than 4 GB.	<ul style="list-style-type: none"> • Use an SD card with a capacity of 4 GB or more.
INCOMPATIBLE CARD. CHECK CARD SPEED.	This is displayed if the maximum writing speed of the SD card is not fast enough.	<ul style="list-style-type: none"> • The operation will continue. • Use an SD card with a maximum writing speed that is fast enough.
CANNOT BE USED DUE TO INCOMPATIBLE DATA.	The SD card cannot be used with this unit.	<ul style="list-style-type: none"> • Insert a recordable SD card.
CANNOT RECORD - INCOMPATIBLE CONTROL DATA.	The content versions do not match. This is displayed when the SD card contains scenes recorded with another device, for example.	<ul style="list-style-type: none"> • Match the device and content version.
ERROR OCCURRED. RECORDING IS STOPPED.	This is displayed when the SD card is removed during recording or data cannot be written to the SD card correctly.	<ul style="list-style-type: none"> • Check the SD card.
CANNOT RECORD.THE NUMBER OF SCENES HAS EXCEEDED THE MAXIMUM LIMIT.	No additional scenes can be recorded to the SD card.	<ul style="list-style-type: none"> • Delete unnecessary scenes, or use a new SD card.
CANNOT RECORD - DATE CAPACITY IS FULL. Cannot record - Playlist capacity is full.	This is displayed when you try to record in excess of the maximum number of scenes allowed for one SD card.	<ul style="list-style-type: none"> • The operation will stop. • Replace the SD card or delete unnecessary scenes.
INVALID	This is displayed when the operation is invalid.	<ul style="list-style-type: none"> • Before performing the operation, wait until this unit is ready for it.
ERROR - UNABLE TO REPAIR DATA.	This is displayed when the management information cannot be recovered.	<ul style="list-style-type: none"> • Check the SD card.

Display	Description	Behavior and cause
CANNOT USE SD CARD IN VIDEO MODE, CONTROL DATA ERROR.	This is displayed when the management information cannot be recovered.	<ul style="list-style-type: none"> • The operation will stop. • Use another SD card to perform recording.
CONTROL DATA ERROR HAS BEEN DETECTED. (SD CARD)	Defective management information has been found.	<ul style="list-style-type: none"> • The management information will be automatically recovered after this message is displayed.
SUPER SLOW MODE NO AUDIO RECORDING	Audio cannot be recorded if you record using Super Slow Recording.	<ul style="list-style-type: none"> • To record audio, disable Super Slow Recording.
CANNOT PLAY.	This is displayed when an error in the recording folder name or file name has occurred, for example.	<ul style="list-style-type: none"> • Check the SD card.

During thumbnail and menu operation

Display	Description	Behavior and cause
NO DATA.	There are no scenes in the currently selected recording mode option and recording format option.	<ul style="list-style-type: none"> • Select a recording mode option or recording format option containing recorded scenes.
CANNOT DELETE.	The content versions do not match. This is displayed when you try to delete scenes recorded with another device, for example.	<ul style="list-style-type: none"> • Match the device and content version.
CARD ERROR. PLEASE REFORMAT.	This is displayed when the SD card cannot be formatted.	<ul style="list-style-type: none"> • Check the SD card. • Replace the SD card in the card slot at which the error has occurred.
UNABLE TO FORMAT.	Formatting is not possible due to, for example, a problem with the SD card.	<ul style="list-style-type: none"> • Check the SD card.
Cannot delete data on card.	The SD card cannot be formatted.	<ul style="list-style-type: none"> • Check the SD card.
CANNOT PROTECT.	The content versions do not match. This is displayed when you try to set protection for scenes recorded with another device, for example.	<ul style="list-style-type: none"> • Match the device and content version.
CANNOT RESET NUMBER.	The SD card cannot be used with this unit.	<ul style="list-style-type: none"> • Insert a recordable SD card.

When connected to an external media

Display	Description	Behavior and cause
CANNOT CHECK CONNECTED DEVICE. DISCONNECT THE USB CABLE FROM THIS UNIT.	This is displayed when the device is connected to this unit with a product such as a USB hub.	<ul style="list-style-type: none"> Do not connect the devices with a product such as a USB hub. Connect to this unit directly.
FORMATTING FAILED.	The external media device cannot be formatted.	<ul style="list-style-type: none"> Change the connected external media device.

During copying between SD cards or copying to an external media device



Display	Description	Behavior and cause
PLEASE CHECK THE EXTERNAL MEDIA.	Copying cannot be performed due to, for example, a problem with the copy destination media device.	<ul style="list-style-type: none"> Check the copy destination media device.
THIS SCENE CANNOT BE COPIED. Cannot copy: contains recordings from other devices.	This is displayed when one or more of the scenes you are trying to copy cannot be played back on this unit.	<ul style="list-style-type: none"> Copy scenes except for the ones that cannot be copied.
COPY FAILED. PLEASE CHECK THE CARD.	An error has occurred while accessing the SD card.	<ul style="list-style-type: none"> Check the SD card.
Cancel card lock to write information.	The write-protect switch of the copy destination SD card is locked.	<ul style="list-style-type: none"> Unlock the write-protect switch of the SD card.

Display

Warning Indications

When an error is detected immediately after this unit is turned on or while it is being operated, the status indicator and on-screen displays inform you of the error.

System error	Status indicator	It flashes once per second.
	On-screen display	—
	Meaning of the warning	A reference signal error or communication error has occurred.
	Recording/playback	The operation stops.
	Solution	Turn off and on this unit. If the warning persists, consult your dealer.

The battery is depleted (Low input voltage)	Status indicator	It flashes once per second.
	On-screen display	The message [LOW BATTERY.] is displayed.
	Meaning of the warning	The battery is depleted.
	Recording/playback	The operation stops. This unit turns off automatically.
	Solution	Charge or replace the battery. Connect the AC adaptor to cancel the warning.
The card is full	Status indicator	—
	On-screen display	The remaining recordable time flashes red when it reaches [R 0h00m].
	Meaning of the warning	The SD card capacity is full.
	Recording/playback	The recording stops.
	Solution	Delete unnecessary scenes, or use a new SD card.
Recording error	Status indicator	It flashes once per second.
	On-screen display	—
	Meaning of the warning	A recording error or recording circuit setting error has occurred.
	Recording/playback	The recording may either continue or stop.
	Solution	Turn off and on this unit. If the warning persists, consult your dealer.
Card error	Status indicator	—
	On-screen display	[] is displayed.
	Meaning of the warning	An SD card error has occurred during recording or playback.
	Recording/playback	The operation stops.
	Solution	Replace the SD card.
The battery will be depleted soon	Status indicator	—
	On-screen display	The message [CHANGE THE BATTERY.] is displayed and  flashes red.
	Meaning of the warning	The battery will be depleted soon.
	Recording/playback	The operation continues.
	Solution	Charge or replace the battery as needed. Connect the AC adaptor to cancel the warning.

The card is nearly full	Status indicator	—
	On-screen display	The remaining recordable time flashes red. (When it is less than 1 minute)
	Meaning of the warning	The SD card is almost out of space.
	Recording/playback	The recording continues.
	Solution	Delete unnecessary scenes or use a new SD card as needed.

Others

Troubleshooting

■ It is not a malfunction in following cases

The lens, the viewfinder or LCD monitor fog up.	<ul style="list-style-type: none"> This is due to condensation. This is not a malfunction. Please refer to page 10.
A clicking sound is heard when the unit is shaken.	<ul style="list-style-type: none"> This is the sound of the lens moving and is not a defect. This sound will no longer be heard when the unit is turned on and switch to Recording Mode.
Object seems to be warped.	<ul style="list-style-type: none"> Object seems to be warped slightly when the object moves across the image very fast, but this is because the unit is using MOS for the image sensor. This is not a malfunction.

Power

Problem	Check points
<p>This unit cannot be turned on.</p> <p>This unit does not stay on long enough.</p> <p>Battery runs down quickly.</p>	<ul style="list-style-type: none"> Charge the battery again to ensure it is sufficiently charged. (→ 24) In cold places, the battery using time becomes shorter. The battery has a limited life. If the operating time is still too short even after the battery is fully charged, the battery has worn out and needs to be replaced.
<p>This unit cannot be operated though it is turned on.</p> <p>This unit does not operate normally.</p>	<ul style="list-style-type: none"> Remove the battery or AC adaptor, wait about 1 minute and then reconnect the battery or AC adaptor. Then about 1 minute later, turn on the unit again. (Conducting the above operation while the SD card is being accessed may damage the data on the media.) If normal operation is still not restored, detach the power connected, and consult the dealer who you purchased this unit from.

Power

Problem	Check points
<p>"ERROR OCCURRED. PLEASE TURN UNIT OFF, THEN TURN ON AGAIN." is displayed.</p>	<ul style="list-style-type: none"> ● The unit has automatically detected an error. Restart the unit by turning off and on. ● The unit will be turned off in about 1 minute if the unit is not turned off and on. ● Repair is needed if it is repeatedly displayed even if it is restarted. Detach the power connected, and consult the dealer who you purchased this unit from. Do not attempt to repair the unit by yourself.



Indication

Problem	Check points
<p>Function display (Remaining Display, Counter Display, etc.) is not displayed.</p>	<ul style="list-style-type: none"> ● [CARD & BATTERY] or [OTHER DISPLAY] of the [DISP SETUP] is [OFF]. (→ 134) ● Touch the icon  to switch the counter display. (→ 63)



Recording

Problem	Check points
<p>The unit arbitrarily stops recording.</p>	<ul style="list-style-type: none"> ● Use an SD card that can be used for motion picture recording. (→ 26) ● The recordable time may have shortened due to the deterioration of the data writing speed or repeated recording and deletion. Using the unit, format the SD card. (→ 38)
<p>Auto Focus function does not work.</p>	<ul style="list-style-type: none"> ● If you are trying to record a scene which is hard to bring into focus in Auto Focus Mode, use the Manual Focus Mode to adjust the focus. (→ 43, 47)
<p>Audio is not recorded.</p>	<ul style="list-style-type: none"> ● Super Slow Recording or Interval Recording is enabled. (→ 78, 127) ●  is displayed and audio is not recorded during Super Slow Recording. ● Audio is not recorded for Interval Recording.
<p>Color or brightness of the image changes, or you may see horizontal bars in the image.</p> <p>The LCD monitor flickers indoors.</p>	<ul style="list-style-type: none"> ● Color or brightness of the image may change, or you may see horizontal bars in the image when the object is recorded under fluorescent light, mercury light or sodium light, etc., but this is not a malfunction. ● Set as below. <ul style="list-style-type: none"> – Record in Auto Shutter Mode. – Adjust the shutter speed to 1/50, 1/60 or 1/100.

Recording

Problem	Check points
Scenes/still pictures cannot be played back.	<ul style="list-style-type: none"> ● Any scenes/still pictures where the thumbnails are displayed as  cannot be played back. ● In most cases,  is displayed for the following scenes: <ul style="list-style-type: none"> – Scenes recorded with another device or edited with editing software – Scenes with damaged data ● The thumbnails of scenes recorded on other devices with different system frequencies are indicated with . This unit cannot play back these scenes.

Playback

Problem	Check points
Scenes/still pictures cannot be deleted.	<ul style="list-style-type: none"> ● Release the protect setting. (→ 97) ● It may not be possible to delete the following scenes/still pictures: <ul style="list-style-type: none"> – Any scenes/still pictures where the thumbnails are displayed as  – Any scenes where the thumbnails are indicated with  <p>If the scenes/still pictures are unnecessary, format the SD card to erase the data. (→ 38) Please be aware that if a SD card is formatted then all the data recorded on the SD card is erased and cannot be recovered. Back up important data on a PC etc.</p>

With other products

Problem	Check points
<p>Although this unit is correctly connected to a TV, images cannot be seen.</p> <p>The images are squeezed horizontally.</p>	<ul style="list-style-type: none"> ● Please read the operating instructions of your TV and select the channel that matches the input used for the connection. ● Change the setting of the unit depending on the cable connecting to the TV. (→ 103)
Even when this unit is connected to the TV by the HDMI cable, images or sounds are not output.	<ul style="list-style-type: none"> ● Check if the HDMI cable is connected correctly. ● Insert the HDMI cable all the way in.
If the SD card is inserted in another device, it is not recognized.	<ul style="list-style-type: none"> ● Check that the device is compatible with the capacity or type of SD card (SDHC Memory Card/SDXC Memory Card) that you inserted. Refer to the operating instructions of the device for details.

Others

Problem	Check points
If the SD card is inserted in this unit, it is not recognized.	<ul style="list-style-type: none">● If the SD card is formatted on a PC, it may not be recognized by this unit. Use this unit to format SD cards. (→ 38)

■ If AVCHD scenes do not change smoothly when played back on another device

The images may be still for several seconds at the joins between the scenes if the following operations are performed when multiple scenes have been continuously played back using another device.

- Just how smoothly the scenes will be played back depends on the playback device. Depending on the device used, the images may stop moving and become still for a moment even when none of the following conditions are applicable.
- A continuous recording of motion picture data that exceeds 4 GB may momentarily stop at every 4 GB of data when played back with another device.

Principal reasons for not playing back smoothly

- The recording format [PS] was switched to another recording format when a scene was recorded
- When the scenes were recorded on different dates
- When scenes lasting under 3 seconds have been recorded
- When PRE-REC was used for recording
- When the Interval Recording is used
- When deleting scenes
- When scenes recorded more than 99 scenes on the same date

About recovery

If faulty management information is found, the messages may appear and a repair is performed. (Repairing may take time depending on the error.)

-  is displayed when abnormal management information is detected when the scenes are displayed in thumbnail.
-
- Use a sufficiently charged battery or the AC adaptor.
 - Depending on the condition of the data, it may not be possible to completely repair the data.
 - If recovery fails, it will not be possible to play back scenes recorded before the unit turned off.
 - When data recorded on another device is recovered, it may not be possible to play back the data on this unit or the other device.
 - If recovery fails, turn the unit off and on again after waiting awhile. If recovery fails repeatedly, format a media on the unit. Please be aware that if a media is formatted, then all the data recorded on the media will be erased.
 - If the thumbnail information is recovered, displaying the thumbnails may become slower.

About copyright

■ Carefully observe copyright laws

Whatever you have recorded and created can be used for your personal entertainment only. Under copyright laws, other materials cannot be used without obtaining permission from the holders of the copyrights.

■ Licenses

- SDXC Logo is a trademark of SD-3C, LLC.
- "AVCHD", "AVCHD Progressive" and the "AVCHD Progressive" logo are trademarks of Panasonic Corporation and Sony Corporation.
- Dolby, Dolby Audio, and the double-D symbol are trademarks of Dolby Laboratories.
- The terms HDMI and HDMI High-Definition Multimedia Interface, and the HDMI Logo are trademarks or registered trademarks of HDMI Licensing Administrator, Inc. in the United States and other countries.
- Microsoft product screen shot(s) reprinted with permission from Microsoft Corporation.
- Other names of systems and products mentioned in these instructions are usually the registered trademarks or trademarks of the manufacturers who developed the system or product concerned.

This product is licensed under the AVC Patent Portfolio License for the personal use of a consumer or other uses in which it does not receive remuneration to (i) encode video in compliance with the AVC Standard ("AVC Video") and/or (ii) decode AVC Video that was encoded by a consumer engaged in a personal activity and/or was obtained from a video provider licensed to provide AVC Video. No license is granted or shall be implied for any other use. Additional information may be obtained from MPEG LA, L.L.C.

See <http://www.mpegla.com>

This product incorporates the following software:

- (1) the software developed independently by or for Panasonic Corporation,
- (2) the software owned by third party and licensed to Panasonic Corporation,
- (3) the software licensed under the GNU General Public License, Version 2.0 (GPL V2.0),
- (4) the software licensed under the GNU LESSER General Public License, Version 2.1 (LGPL V2.1), and/or
- (5) open source software other than the software licensed under the GPL V2.0 and/or LGPL V2.1.

The software categorized as (3) - (5) are distributed in the hope that it will be useful, but WITHOUT ANY WARRANTY, without even the implied warranty of MERCHANTABILITY or FITNESS FOR A PARTICULAR PURPOSE. For more information, refer to the license conditions described in the supplied separate leaflet "Open Source Software Information".

At least three (3) years from delivery of this product, Panasonic will give to any third party who contacts us at the contact information provided below, for a charge no more than our cost of physically performing source code distribution, a complete machine-readable copy of the corresponding source code covered under GPL V2.0 or LGPL V2.1, as well as the respective copyright notice thereof.

Contact Information: oss-cd-request@gg.jp.panasonic.com

The source code and the copyright notice are also available for free in our website below.
<https://panasonic.net/cns/oss/index.html>

Recording functions that cannot be used simultaneously

Due to the specifications of this unit, depending on the recording function being used, it is not possible to use or select certain other recording functions.

● “○”: Available; “—”: Not available*

* “Not available” includes instances where the desired function cannot be used or selected.

Recording function to be set	Currently set recording function			
	Interval Rec	Super Slow Recording	Relay recording	Simultaneous recording
Interval Rec (→ 127)		—	○	○
Super Slow Recording (→ 78, 128)	○		○	○
Relay recording (→ 126)	—	—		○
Simultaneous recording (→ 126)	○	○	○	
PRE-REC (→ 77, 128)	—	—	○	○
Capture (→ 74)	—	—	○	○
Black Fade (→ 69)	—	—	○	○
White Fade (→ 69)	—	—	○	○
Recording Check (→ 71)	—	○	○	—
Last Scene Delete (→ 71)	—	○	○	—

Recording modes/approximate recordable time

- SD cards are only mentioned with their main memory size. The stated times are the approximate recordable times for continuous recording.
 - “h” is an abbreviation for hour, “min” for minute and “s” for second.
 - If recording for long periods, prepare batteries for 3 or 4 times the period you wish to record for. (→ 25)
 - The default setting for [REC MODE] is [AVCHD], and the default setting for [REC FORMAT] is [PH 1080/59.94i].
 - Maximum continuously recordable time for one scene: 10 hours*
 - The recording is paused once when the recording time for one scene exceeds 10 hours, and the recording will automatically resume after a few seconds.*
 - For information on the maximum continuous recordable time for one scene during Super Slow Recording, refer to page 79.
 - The recordable time may be reduced if recording with a lot of action is recorded or recording of short scene is repeated.
 - The recordable times depends on the recording condition or card type to be recorded.
 - For information on picture sizes, frame rates, and bit rates in [REC FORMAT], refer to page 118.
- * Including when recording is performed with [2 SLOTS FUNC.] set to [RELAY REC]

• When [REC MODE] is set to [MOV] or [MP4]





Recording format	SD card		
	4 GB	16 GB	64 GB
[FHD 1080/59.94p 50M]	10 min	40 min	2 h 40 min
[FHD 1080/29.97p 50M]			
[FHD 1080/23.98p 50M]			
[FHD 1080/59.94i 50M]			

• When [REC MODE] is set to [AVCHD]

Recording format	SD card		
	4 GB	16 GB	64 GB
[PS 1080/59.94p]	19 min	1 h 20 min	5 h 20 min
[PH 1080/59.94i]	21 min	1 h 30 min	6 h
[PH 1080/23.98p]			
[HA 1080/59.94i]	30 min	2 h	8 h 30 min
[HE 1080/59.94i]	1 h 30 min	6 h 40 min	27 h 30 min
[PM 720/59.94p]	1 h	4 h 15 min	17 h 10 min
[SA 480/59.94i]	1 h	4 h	16 h 30 min

Approximate number of recordable pictures

- SD cards are only mentioned with their main memory size. The stated number is the approximate number of recordable pictures.

Picture size	Aspect ratio	Memory Card		
		4 GB	16 GB	64 GB
 1920×1080	16:9	3200	12500	52000
 1280×720		7000	29000	118000
 640×360		4:3	28000	117000
 640×480				

- Maximum number of recordable pictures that can be displayed is 9999. If the number of recordable pictures exceeds 9999, R 9999+ is displayed. The number will not change when the picture is taken until the number of recordable pictures is 9999 or less.
- The number of recordable pictures depends on the recording condition or card type to be recorded.
- The memory capacity indicated on the label of an SD card is the total of the capacity for copyright protection and management and the capacity which can be used on the unit, a PC etc.

Specification

High Definition Video Camera

Power source:

7.2 V --- (When using battery)

12 V --- (When using AC adaptor)

Power consumption:

27.4 W (During recording: 9.2 W; during charging: 27.4 W)



indicates safety information

Recording format:

[MOV]/[MP4]

AVCHD version 2.0

(AVCHD Progressive)

Motion picture compression:

MPEG-4 AVC/H.264

Audio compression:

[MOV]/[MP4]; Linear PCM

[AVCHD]; Dolby Audio

Motion picture recording:

Recording method; MOV, MP4, AVCHD

Recording format;

- When [REC MODE] = [MOV], [MP4]
[FHD 1080/59.94p 50M]/
[FHD 1080/29.97p 50M]/
[FHD 1080/23.98p 50M]/
[FHD 1080/59.94i 50M];
Average 50 Mbps (VBR)
- When [REC MODE] = [AVCHD]
[PS 1080/59.94p]; Average 25 Mbps (VBR)
[PH 1080/59.94i]; Average 21 Mbps (VBR)
[PH 1080/23.98p]; Average 21 Mbps (VBR)
[HA 1080/59.94i]; Average 17 Mbps (VBR)
[HE 1080/59.94i]; Average 5 Mbps (VBR)
[PM 720/59.94p]; Average 8 Mbps (VBR)
[SA 480/59.94i]
(When [ASPECT CONVERT] = [SIDE
CROP], [SQUEEZE]);
Average 9 Mbps (VBR)

Refer to page 155 for the picture size and recordable time of a motion picture.

Still picture recording:

Recording method; JPEG corresponding

(Design rule for Camera File system, based on Exif 2.2 standard)

Refer to page 156 for picture size of a still picture and number of recordable pictures.

Recording media:

SDHC Memory Card (4 GB to 32 GB)/

SDXC Memory Card (48 GB to 128 GB)

Refer to page 26 for details on SD cards usable in this unit.

Recording slots:

2 slots

2 Slot function:

Relay, simultaneous

System frequency:

59.94 Hz

Image sensor:

1/3.1" MOS image sensor

Effective pixels;

Motion picture/Still picture;

Approx. 6030 K (16:9)

Lens:

Auto Iris optical zoom (Full range AF)

F value (focal length)

F1.8 to F3.6 (Focal length; 4.08 mm to 81.6 mm)

35 mm equivalent;

Motion picture/Still picture;

29.5 mm to 612.0 mm (16:9)

Minimum focus distance;

Approx. 3 cm (1.2") (Wide/

Approx. 1.5 m (4.9 feet) (Tele)

Filter diameter:

49 mm

Zoom:

20× optical zoom, 40× i.Zoom,

2×/5×/10× digital zoom

White balance adjustment:

[ATW], [ATW LOCK], [Ach], [Bch],

preset 3200K, preset 5600K, VAR (2000K to 15000K)

Shutter speed:

1/8 to 1/8000

1/6 to 1/8000 (at 23.98p)

1/120 to 1/8000 (During Super Slow Recording)

Super Slow Recording:

Recording frame rate; FHD 120 fps
 Slow motion effect; 1/2, 1/4 or 1/5 the normal speed

Image stabilizer function:

Optical (with 5-Axis Hybrid O.I.S.)

Level Shot Function:

[ON]/[OFF]

Monitor:

3" wide LCD monitor
 (Approx. 460 K dots)

Viewfinder:

0.24" wide EVF
 (Approx. 1555 K dots equivalent)

Microphone:

Stereo microphone

Minimum required illumination:

Approx. 1.4 lx (at a Super Gain value of 36 dB and a shutter speed of 1/30)

Built-in LED light:

Illumination level; Approx. 300 lx (1.0 m)
 With the diffusion filter; Approx. 70 lx (1.0 m)
 Illuminating angle; Approx. 30°
 Color temperature; Approx. 5000 K

Video output:**HDMI Type A connector video output level;**

1080/59.94p/29.97p/23.98p/59.94i,
 720/59.94p, 480/59.94p,
 VIERA Link not supported

AV connector video output level;

1.0 Vp-p, 75 Ω

Audio output:**HDMI Type A connector audio output level;**

Linear PCM

AV connector audio output level (Line);

2 ch

Headphone output;

3.5 mm (0.14 ") stereo mini jack

Camera remote terminal:

2.5 mm (0.1 ") super mini jack × 1 (ZOOM S/S)
 3.5 mm (0.14 ") mini jack × 1 (FOCUS/IRIS)

MIC input:

-60 dBV (Mic sensitivity -40 dB equivalent,
 0 dB=1 V/Pa, 1 kHz)
 Input impedance; 5600 Ω
 (Stereo mini jack)

USB:

USB terminal Type A
 Hi-Speed USB (USB 2.0), (for external media device connection*), bus power supported

* External media device with a capacity of 32 GB or below or a capacity above 2 TB cannot be used.

Dimensions:

205 mm (W)×217 mm (H)×494 mm (D)
 [8.07 " (W)×8.54 " (H)×19.4 " (D)]

Mass (Weight):

Approx. 2330 g (Approx. 5.14 lbs.)
 [without the battery (supplied) and SD cards (optional)]

Mass (Weight) in operation:

Approx. 2450 g (Approx. 5.4 lbs.)
 [with the battery (supplied) and two SD cards (optional)]

Operating temperature:

0 °C to 40 °C (32 °F to 104 °F)

Operating humidity:

10%RH to 80%RH

Battery operation time:

See page 25.

AC adaptor**Power source:**

100 V to 240 V ~, 50 Hz/60 Hz, 1.2 A
 79 VA (for 100 V ~)
 99 VA (for 240 V ~)

Power output:

12 V ==, 3.0 A, 36 W

 indicates safety information

Ambient operating temperature:

0 °C to 40 °C (32 °F to 104 °F)

Ambient operating humidity:

10%RH to 90%RH (no condensation)

Mass (Weight):

Approx. 225 g (Approx. 0.496 lbs.)

Dimensions (W×H×D):

115 mm×37 mm×57 mm
 [4-17/32 " × 1-15/32 " × 2-1/4 "]
 (Excluding the DC cord portion)

The symbols on this product (including the accessories) represent the following:

~	AC
==	DC
	Class II equipment (The construction of the product is double-insulated.)

Useful Information (Only For Latin American Countries)

Customer Service

Customer Service Directory

Obtain products information and operative assistant; localize the closer distributor or Service Center; buy spare parts and accessories by our Web Site to Latin American:

COUNTRY	WEB SITE	CONTACT CENTER
Panama	www.panasonic.com/pa/soporte/	800-7262
Colombia	www.panasonic.com/co/soporte/	01-8000-947262
Ecuador	www.panasonic.com/ec/soporte/	1-800-726276
Costa Rica	www.panasonic.com/cr/soporte/	800-7262737
El Salvador	www.panasonic.com/sv/soporte/	800-7262
Guatemala	www.panasonic.com/gt/soporte/	1-801-811-7262
Uruguay	www.panasonic.com/uy/soporte/	0-800-7262
Paraguay	www.panasonic.com/uy/soporte/	0-800-11-7262
Chile	www.panasonic.com/cl/soporte/	800-390-602 022-797-5000
Peru	www.panasonic.com/pe/soporte/	0800-00726
Venezuela	www.panasonic.com/ve/soporte/	800-7262-800
Mexico	www.panasonic.com/mx/soporte/	01800-847-7262 55-5000-1200
Argentina	www.panasonic.com/ar/soporte/	0800-333-7262 0810-321-7262
Dominican Republic	www.panasonic.com/do/soporte/	809-200-8000

Panasonic Corporation

Web site: <http://www.panasonic.com>

Panasonic Corporation of North America

Two Riverfront Plaza, Newark, NJ 07102-5490

<http://shop.panasonic.com>

Panasonic Canada Inc.

5770 Ambler Drive, Mississauga, Ontario, L4W 2T3

www.panasonic.com

© Panasonic Corporation 2018