

# Technics®



## Operating Instructions

### Network CD Receiver

### SA-C100

Music is borderless and timeless, touching people's hearts across cultures and generations.

Each day the discovery of a truly emotive experience from an unencountered sound awaits.

Let us take you on your journey to rediscover music.

Rediscover Music™

**Technics**

## Delivering the Ultimate Emotive Musical Experience to All

At Technics we understand that the listening experience is not purely about technology but the magical and emotional relationship between people and music.

We want people to experience music as it was originally intended and enable them to feel the emotional impact that enthuses and delights them.

Through delivering this experience we want to support the development and enjoyment of the world's many musical cultures. This is our philosophy.

With a combination of our love of music and the vast high-end audio experience of the Technics team, we stand committed to building a brand that provides the ultimate emotive musical experience by music lovers, for music lovers.

Director  
Michiko Ogawa

A handwritten signature in black ink, reading "Michiko Ogawa". The signature is fluid and cursive, with a long horizontal flourish extending to the right.

Thank you for purchasing this product.

Please read these instructions carefully before using this product, and save this manual for future use.

- About descriptions in these operating instructions
  - Pages to be referred to are indicated as “⇒ ○○”.
  - The illustrations shown may differ from your unit.
  - Unless otherwise indicated, operations are described using the remote control.

## Sales and Support Information

### **Customer Communications Centre**

- For customers within the UK: 0333 222 8777
- For customers within Ireland: +353 1 912 4460
- Monday–Friday 9:00 am – 5:00 pm, (Excluding public holidays).
- For further support on your product, please visit our website: [www.technics.com/uk/](http://www.technics.com/uk/)

# Features

Wide compatibility of music source can be easily accessed

Amplifier, CD player and network player are installed in one slim and compact body.

The music contents such as Hi-res music sources, the latest music streaming service, Bluetooth®, AirPlay 2, USB, line-optical input, CD, radio, etc. are widely available.

Colourful and rich sound space

High-quality audio technologies originally developed by Technics such as the full digital amplifier function “JENO Engine” reproduces the sound information precisely, achieve the clearer sound position and open sound space expression.

Optimum sound adjustment with Space Tune

4 preset modes such as “Wall” which is suitable to install the speakers near the wall are implemented to the Space Tune function provides the optimum sound according to the customer’s room or speaker location. The dedicated application “Technics Audio Center” is available for more precise adjustment.

# Table of contents

---

Read first	06
------------	----

Please carefully read the "Safety precautions" of this manual before use.

---

Control reference guide	14
-------------------------	----

This unit, Remote control

---

Connections	22
-------------	----

Antenna connection, AC mains lead connection, Network settings

---

Operations	34
------------	----

Playing back CDs, etc.

---

Settings	86
----------	----

Sound adjustment, Other settings

---

Others	100
--------	-----

Troubleshooting, Specifications, etc.

---

# Accessories

AC mains lead (1)  
K2CT3YY00096

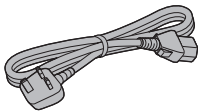

DAB antenna (1)  
N1EYYY000015

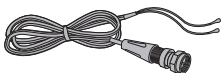

Remote control (1)  
N2QAYA000230

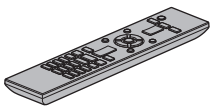

Batteries for remote control (2)



- Product numbers provided in these operating instructions are correct as of December 2021.
- These may be subject to change.
- Do not use AC mains lead with other equipment.

# Read first

<b>Safety precautions.....</b>	<b>07</b>
Warning .....	07
Caution .....	08
<b>Installation .....</b>	<b>13</b>
Installation .....	13
Unit care .....	13
To dispose of or transfer this unit .....	13

🔄 Table of contents ... 04

## Safety precautions

### Warning

#### Unit

- To reduce the risk of fire, electric shock or product damage,
  - Do not expose this unit to rain, moisture, dripping or splashing.
  - Do not place objects filled with liquids, such as vases, on this unit.
  - Use only the recommended accessories.
  - Do not remove covers.
  - Do not repair this unit by yourself. Refer servicing to qualified service personnel.
  - Do not let metal objects fall inside this unit.
  - Do not place heavy items on this unit.

#### AC mains lead

- To reduce the risk of fire, electric shock or product damage,
  - Ensure that the power supply voltage corresponds to the voltage printed on this unit.
  - Insert the mains plug fully into the socket outlet.
  - Do not pull, bend, or place heavy items on the lead.
  - Do not handle the plug with wet hands.
  - Hold onto the mains plug body when disconnecting the plug.
  - Do not use a damaged mains plug or socket outlet.
- The mains plug is the disconnecting device. Install this unit so that the mains plug can be unplugged from the socket outlet immediately.
- Ensure the earth pin on the mains plug is securely connected to prevent electrical shock.
  - An apparatus with CLASS I construction shall be connected to a mains socket outlet with a protective earth connection.

## Caution

### Unit

- Do not place sources of naked flames, such as lighted candles, on this unit.
- This unit may receive radio interference caused by mobile telephones during use. If such interference occurs, please increase separation between this unit and the mobile telephone.
- This unit is intended for use in moderate and tropical climates.
- Do not put any objects on this unit. This unit becomes hot while it is on.
- This unit utilizes a laser. Use of controls or adjustments or performance of procedures other than those specified herein may result in hazardous radiation exposure.
- Do not look at the laser with an observation optical system like magnifying glass, however it does not affect the human health.
- Keep magnetic items away from the product. Powerful magnets inside the top cover and disc tray part may damage debit cards, travel cards (transit passes), clocks and other objects.

### Placement

- Place this unit on an even surface.
- To reduce the risk of fire, electric shock or product damage,
  - Do not install or place this unit in a bookcase, built-in cabinet or in another confined space. Ensure this unit is well ventilated.
  - Do not obstruct this unit's ventilation openings with newspapers, tablecloths, curtains, and similar items.
  - Do not expose this unit to direct sunlight, high temperatures, high humidity, and excessive vibration.
- Do not lift or carry this unit by holding the top cover or front of this unit. Doing so may cause this unit to fall, resulting in personal injury or malfunction of this unit.

### Battery

- Danger of explosion if battery is incorrectly replaced. Replace only with the type recommended by the manufacturer.
- Mishandling of batteries can cause electrolyte leakage and may cause a fire.
  - Remove the battery if you do not intend to use the remote control for a long period of time. Store in a cool, dark place.
  - Do not heat or expose to flame.
  - Do not leave the battery(ies) in a car exposed to direct sunlight for a long period of time with doors and windows closed.
  - Do not take apart or short circuit.
  - Do not recharge alkaline or manganese batteries.
  - Do not use batteries if the covering has been peeled off.



- Do not mix old and new batteries or different types at the same time.
- When disposing of the batteries, please contact your local authorities or dealer and ask for the correct method of disposal.
- Avoid the use in the following conditions
  - High or low extreme temperatures during use, storage or transportation.
  - Replacement of a battery with an incorrect type.
  - Disposal of a battery into fire or a hot oven, or mechanically crushing or cutting of a battery, that can result in an explosion.
  - Extremely high temperature and/or extremely low air pressure that can result in an explosion or the leakage of flammable liquid or gas.



## Caution for AC Mains Lead

(For the AC mains plug of three pins)

For your safety, please read the following text carefully.

This appliance is supplied with a moulded three pin mains plug for your safety and convenience.

A 3-ampere fuse is fitted in this plug.

Should the fuse need to be replaced please ensure that the replacement fuse has a rating of 3-ampere and that it is approved by ASTA or BSI to BS1362.

Check for the ASTA mark  or the BSI mark  on the body of the fuse.

If the plug contains a removable fuse cover you must ensure that it is refitted when the fuse is replaced.

If you lose the fuse cover the plug must not be used until a replacement cover is obtained.

A replacement fuse cover can be purchased from your local dealer.

### Before use

Remove the connector cover.

### How to replace the fuse

The location of the fuse differ according to the type of AC mains plug (figures A and B). Confirm the AC mains plug fitted and follow the instructions below. Illustrations may differ from actual AC mains plug.

1. Open the fuse cover with a screwdriver.

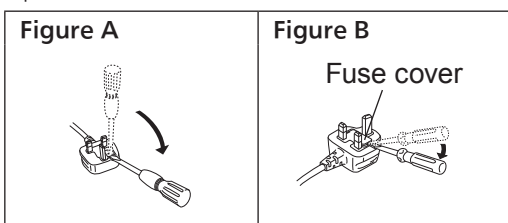

2. Replace the fuse and close or attach the fuse cover.

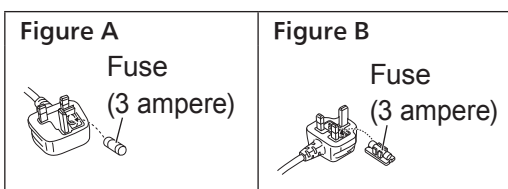

Panasonic Corporation, a company having its registered office of 1006, Oaza Kadoma, Kadoma City, Osaka 571-8501, Japan, automatically collects personal data such as IP address and/or Device ID from your device as soon as you connect it to the Internet. We do this to protect our customers and the integrity of our Service as well as to protect the rights or property of Panasonic.

You have a right of access, rectification and objection to in certain circumstances, a right of erasure, restriction of processing, data portability and a right to object to other forms of processing. If you wish to exercise any of the above rights and/or wish to know more about the processing of your personal data in this context, please refer to the full text of our privacy policy displayed at the support page of your device, <http://panasonic.jp/support/global/cs/audio/>, <http://www.technics.com/support/> or contact our customer communications/support number or address described in the Pan European Guarantee included in your device box to send you the full text of our privacy policy.

### **Disposal of Old Equipment and Batteries Only for European Union and countries with recycling systems**



These symbols on the products, packaging, and/or accompanying documents mean that used electrical and electronic products and batteries must not be mixed with general household waste.

For proper treatment, recovery and recycling of old products and used batteries, please take them to applicable collection points in accordance with your national legislation.

By disposing of them correctly, you will help to save valuable resources and prevent any potential negative effects on human health and the environment.

For more information about collection and recycling, please contact your local municipality.

Penalties may be applicable for incorrect disposal of this waste, in accordance with national legislation.



#### **Note for the battery symbol (bottom symbol):**

This symbol might be used in combination with a chemical symbol. In this case it complies with the requirement set by the Directive for the chemical involved.

### EU Declaration of Conformity (DoC)

Hereby, "Panasonic Corporation" declares that this product is in compliance with the essential requirements and other relevant provisions of Directive 2014/53/EU.

Customers can download a copy of the original DoC to our RE products from our DoC server:

<https://www.ptc.panasonic.eu>

Contact to Authorised Representative:

Panasonic Marketing Europe GmbH, Panasonic Testing Centre, Winsbergring 15, 22525 Hamburg, Germany

5.15 - 5.35 GHz band is restricted to indoor operations only in the following countries.

AT	BE	BG	CZ	DK	EE	FR	DE	IS
IE	IT	EL	ES	CY	LV	LI	LT	LU
HU	MT	NL	NO	PL	PT	RO	SI	SK
TR	FI	SE	CH	UK(NI)	HR			

### UK Declaration of Conformity (DoC)

Hereby, "Panasonic Corporation" declares that this product is in compliance with the essential requirements and other relevant provisions of the Radio Equipment Regulations 2017 No.1206.

Customers can download a copy of the original DoC to our RE products from our DoC server:

<https://www.ptc.panasonic.eu/compliance-documents>

Contact in the UK : Panasonic Testing Centre on behalf of Panasonic UK, a branch of Panasonic Marketing Europe GmbH (Importer)

Maxis 2, Western Road, Bracknell, Berkshire, RG12 1RT

5.15 – 5.35 GHz band is restricted to indoor operations only in the United Kingdom.

Type of wireless	Frequency band	Maximum power (dBm e.i.r.p.)
WLAN	2412 - 2472 MHz	18 dBm
	5180 - 5320 MHz	18 dBm
	5500 - 5700 MHz	18 dBm
	5745 - 5825 MHz	14 dBm
Bluetooth®	2402 - 2480 MHz	4 dBm

# Installation

---

## Installation

- Turn off all the equipment before connection and read the appropriate operating instructions. Be sure to raise this unit when moving, and do not drag this unit.

## Unit care

- Pull out the AC mains lead from the socket before maintenance. Clean this unit with a soft cloth.
- When dirt is heavy, wring a wet cloth tightly to wipe the dirt, and then wipe it with a soft cloth.
- Do not use solvents including benzene, thinner, alcohol, kitchen detergent, chemical wiper, etc. Doing so may cause the exterior case to be deformed or the coating to come off.

## To dispose of or transfer this unit

This unit may contain private information. Before disposing of or transferring this unit, perform the following to delete the data, including personal or secret information.

- "To restore all the settings to the factory defaults"  
(⇒ 102)

# Control reference guide

<b>This unit (front)</b> .....	<b>15</b>
<b>This unit (rear)</b> .....	<b>17</b>
<b>Remote control</b> .....	<b>18</b>
Using the remote control .....	20
Remote control mode .....	20
<a href="#">↻ Table of contents ...</a>	04

## This unit (front)

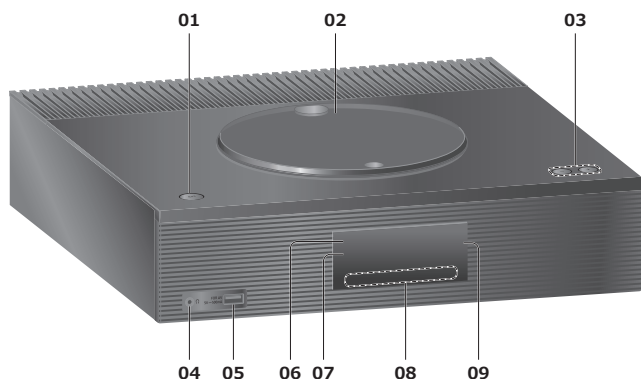

### 01 Standby/on switch (⏻/⏻)

- Press to switch the unit from on to standby mode or vice versa. In standby mode, the unit is still consuming a small amount of power.

### 02 Top cover

(⇒ 37)

- The magnet is built-in to keep the top cover closing.
- Do not apply too much force to the top cover when sliding it. Doing so may cause malfunction.
- Do not leave the top cover open for a prolonged period. Doing so will cause the lens to become dirty.

### 03 Adjust volume

- 0 (min) to 100 (max)

### 04 Headphones jack

- When a plug is connected, the speakers do not output sound.
- Excessive sound pressure from earphones and headphones can cause hearing loss.
- Listening at full volume for long periods may damage the user's ears.

### 05 USB-A terminal (For AV) (5 V $\equiv$ 500 mA)

- Port for USB devices (⇒ 50)

### 06 Power indicator

- Blue: The unit is on.
- Red: The unit is in standby mode with the network standby function.
- Off: The unit is in standby mode with no function available.

### 07 Remote control signal sensor

- Reception distance:  
Within approx. 7 m directly in front
- Reception angle:  
Approx. 30° left and right

## 08 Touch switches

- [SELECT]:  
Switch the input source  
(⇒ 50, 54, 57, 59, 62, 69, 73, 77)
- [⏮], [⏭], [■], [▶/⏸]:  
Playback operation buttons
- Each time you press the switch, a beep sound will be heard. (⇒ 95)

## 09 Display

- Input source, clock, playback status, etc. are displayed. (⇒ 109)



## This unit (rear)

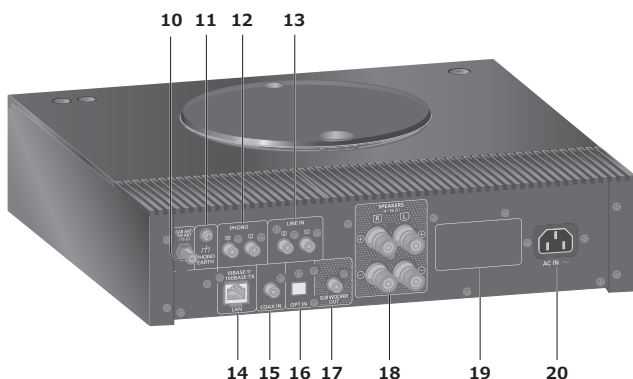

**10 DAB ANT/FM ANT terminal**

(⇒ 23, 41, 45)

**11 PHONO EARTH terminal**

(⇒ 56)

- For connecting the ground wire of a turntable.

**12 Analogue audio input terminals (PHONO)**

(⇒ 56)

- Please use the cable less than 3 m.

**13 Analogue audio input terminals (LINE)**

(⇒ 56)

**14 LAN terminal**

(⇒ 29)

**15 Coaxial digital input terminals (COAX)**

(⇒ 54)

**16 Optical digital input terminal (OPT)**

(⇒ 54)

**17 Subwoofer terminal**

**18 Speaker output terminals**

(⇒ 24)

**19 Product identification marking**

- The model number is indicated.

**20 AC IN terminal (∼)**

(⇒ 26)

## Remote control

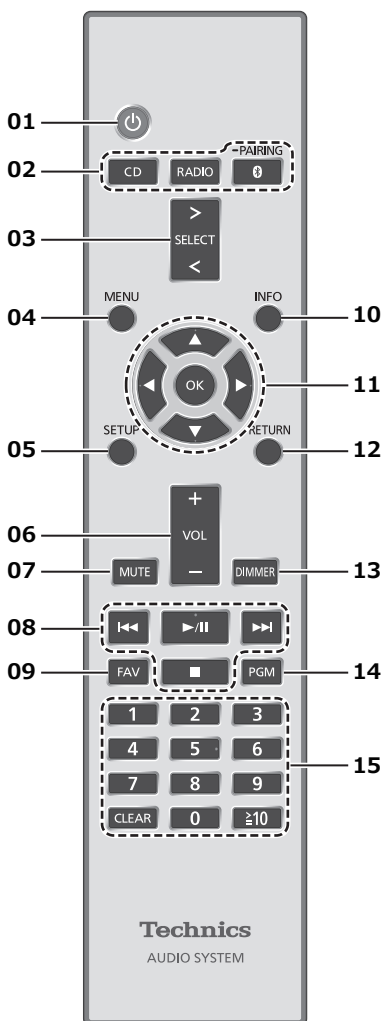

### 01 [ ]: Standby/on switch

- Press to switch the unit from on to standby mode or vice versa. In standby mode, the unit is still consuming a small amount of power.

### 02 [CD]/[RADIO]/[ -PAIRING]: Select the device to be operated

(⇒ 37, 41, 45, 47)

### 03 [>SELECT<]: Switch the input source

(⇒ 50, 54, 57, 59, 62, 69, 73, 77)

### 04 [MENU]: Enter menu

(⇒ 39, 41, 45, 47, 51, 57, 60, 63, 64, 70, 74, 78)

### 05 [SETUP]: Enter setup menu (⇒ 89)

### 06 [+VOL-]: Adjust the volume

- 0 (min) to 100 (max)

## **07 [MUTE]: Mute the sound**

- Press [MUTE] again to cancel. "MUTE" is also cancelled when you adjust the volume or when you turn the unit to standby.

## **08 Playback operation buttons**

## **09 [FAV]: Select the favourite radio station or playlist (DAB/DAB+, FM, Internet Radio, Podcasts, etc.)**

- You can register up to 9 favourite stations. (⇒ 88)

## **10 [INFO]: View content information**

- Press this button to display the track, artist, and album names, file type, sampling frequency, and other information. (The information varies depending on the input source.)
- Press and hold this button to display the setting status of "RE-MASTER".

## **11 [▲], [▼], [◀], [▶]/[OK]: Selection/OK**

## **12 [RETURN]: Return to the previous display**

## **13 [DIMMER]: Adjust the brightness of the display, etc.**

- When the display is turned off, it will light up for a few seconds only when you operate this unit. Before the display turns off, "Display Off" will be displayed for a few seconds.
- Press repeatedly to switch the brightness.

## **14 [PGM]: Set the programme function**

## **15 Numeric buttons, etc.**

- To select a 2-digit number  
Example:  
16: [≧10] > [1] > [6]
- To select a 4-digit number  
Example:  
1234: [≧10] > [≧10] > [≧10] > [1] > [2] > [3] > [4]
- [CLEAR]: Clear the entered value.

## Using the remote control

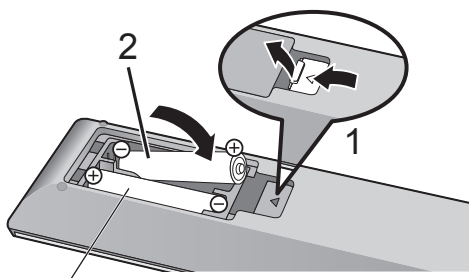

R03/LR03, AAA  
(Alkaline or manganese batteries)

### Note

- Insert the battery so the terminals ( $\oplus$  and  $\ominus$ ) match those in the remote control.
- Point it at the remote control signal sensor on this unit. ( $\Rightarrow$  15)
- Keep the batteries out of reach of children to prevent swallowing.

## Remote control mode

When other equipment responds to the supplied remote control, change the remote control mode.

- The factory default is "Mode 1".

**1 Press [SETUP].**

**2 Press [ $\blacktriangle$ ], [ $\blacktriangledown$ ] to select "Remote Control" and then press [OK].**

- The current remote control mode of this unit is displayed.

**3 When "Set Mode 1/2" is displayed, change the remote control mode of the remote control.**

To set "Mode 1":

Press and hold [OK] and [1] for at least 4 seconds.

To set "Mode 2":

Press and hold [OK] and [2] for at least 4 seconds.

**4 Point the remote control at this unit, and press and hold [OK] for at least 4 seconds.**

- When the remote control mode is changed, the new mode will appear on the display for a few seconds.

■ **When “Remote 1” or “Remote 2” is displayed**

When “Remote 1” or “Remote 2” is displayed, the remote control modes of this unit and remote control are different. Perform step 3 above.

# Connections

<b>Antenna</b> .....	<b>23</b>
Antenna connection.....	23
<b>Speakers</b> .....	<b>24</b>
Speaker connection .....	24
<b>AC mains lead</b> .....	<b>26</b>
AC mains lead connection .....	26
<b>Network settings</b> .....	<b>27</b>
Wired LAN connection.....	29
Wireless LAN connection .....	30
This unit's name on the network "Friendly Name" .....	33
To check the MAC address of this unit "MAC Address" .....	33

[↶ Table of contents ...](#) 04

## Antenna

- This unit can receive DAB+ and FM stations with the DAB antenna.

### Antenna connection

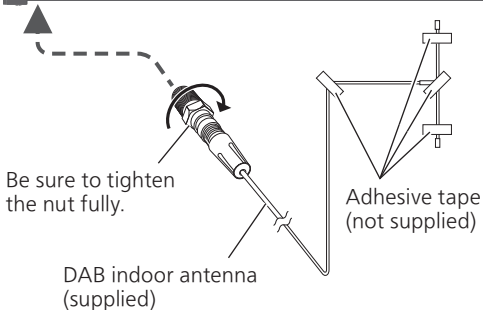
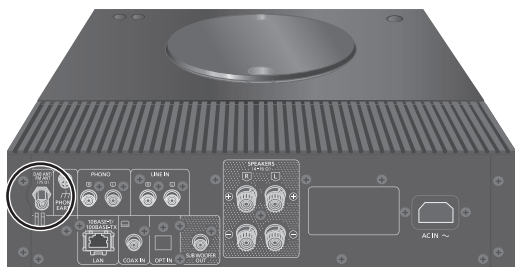

- Tape the antenna to a wall or column at the position with the least amount of interference.
- If radio reception is poor, use a DAB outdoor antenna (not supplied).

#### Note

- The interference may occur if any electronic devices are nearby.

### Speaker connection

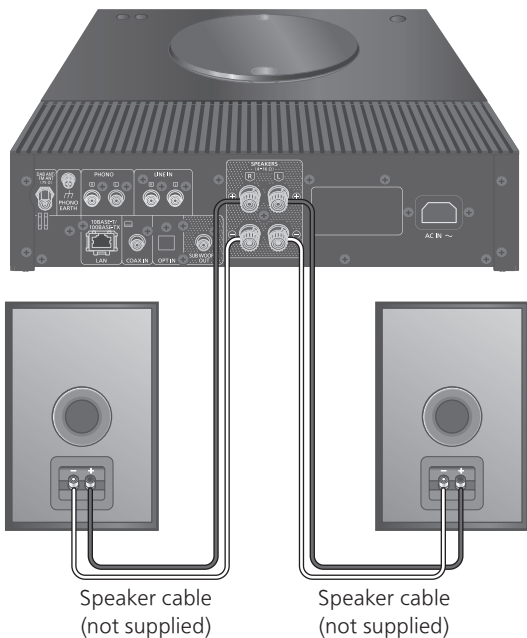

- 1 Turn the knobs to loosen them, and insert the core wires into the holes.

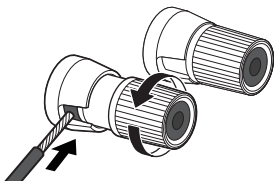

- 2 Tighten the knobs.

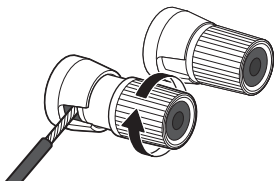

#### Note

- When the connections are completed, pull the speaker cables lightly to check that they are connected firmly.
- Be careful not to cross (short-circuit) or reverse the polarity of the speaker wires as doing so may damage the amplifier.



**DO NOT**

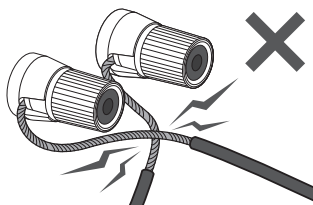

- Wire the polarity (+/-) of the terminals correctly. Not doing so may adversely affect stereo effects or cause malfunction.
- For details, refer to the operating instructions of the speakers.

## AC mains lead

- Use only the supplied AC mains lead.
- Insert the plugs of the cables to be connected all the way in.
- Do not bend cables at sharp angles.

### AC mains lead connection

**Connect only after all other connections are completed.**

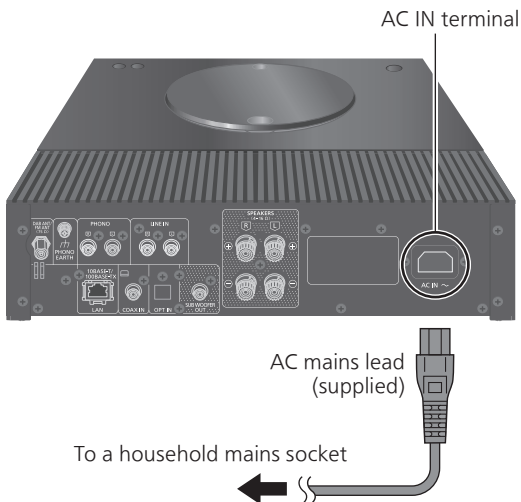

- Wireless LAN (Wi-Fi®) setting may start when this unit is turned on. If you stop the Wi-Fi setting, select "No" in "Wi-Fi Setup" screen. Select "Yes" to keep the Wi-Fi setting. (⇒ 30)

#### Note

- This unit consumes a small amount of AC power (⇒ 117) even when the unit is in standby mode. Remove the plug from the main electrical outlet if you will not be using the unit for an extended period of time. Place the unit so the plug can be easily removed.

## Network settings

You can stream online music services or music files from your smartphone/tablet to this unit. To use these features, this system must join the same internet-connected network as the compatible device.

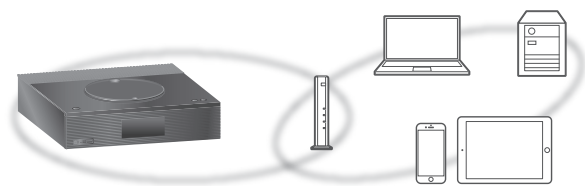

This unit can be connected to a router using a LAN cable or built-in Wi-Fi®.

For a stable connection to the network, a wired LAN connection is recommended.

### Note

- If you try to change the network settings immediately after turning on this unit, it may take some time until the network setup screen is displayed.
- If “Firmware update is available” is displayed after the network connection is set up, the firmware for this unit is available.
  - Refer to “Firmware updates” (⇒ 98) for details on update.
  - For the update information, refer to the following website.  
[www.technics.com/support/firmware/](http://www.technics.com/support/firmware/)

### ■ Preparation

If you install the Google Home app on your smartphone/tablet, you can set up a connection using the application.

- When using Google Cast™-enabled apps to play music on this unit, set up a connection using the Google Home app.
- Make sure that the Wi-Fi function is activated on your smartphones/tablet.

### 1 Install the Google Home app on your smartphone/tablet.

- To download the Google Home app, visit:  
<https://www.google.com/cast/setup/>



## 2 Connect your smartphone/tablet to the same network as this unit before setting.

- Make sure that the network is connected to the Internet.

### Note

- For using stream audio via AirPlay, you do not have to set up using the Google Home app. You can use the Apple Home app to add this unit to the network. Adding this unit to the network via the Apple Home app will also allow the user to stream audio using Siri.

## Wired LAN connection

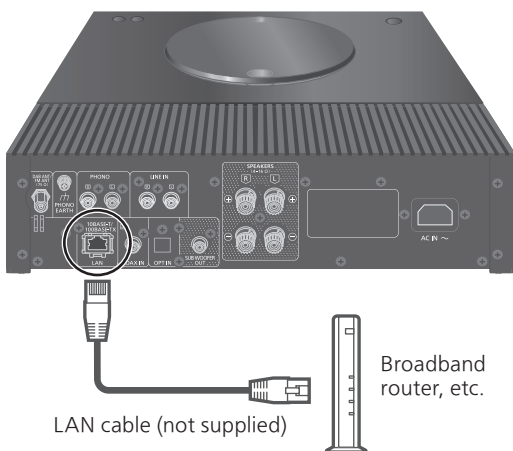

- 1 **Disconnect the AC mains lead.**
- 2 **Connect this unit to a broadband router, etc. using a LAN cable.**
- 3 **Connect the AC mains lead to this unit, and press [⏻]. (⇒ 26)**
  - When the connection is established, "  " is displayed.
- 4 **Press [>SELECT<] to select "Google Cast".**
- 5 **Open the Google Home app and follow the on-screen instructions to set up a connection. (⇒ 31)**

### Note

- While the AC mains lead is disconnected, the LAN cable must be connected or disconnected.
- Use category 7 or above straight LAN cables (STP) when connecting to peripheral devices.
- Inserting any cable other than a LAN cable in the LAN port can damage the unit.
- When a LAN cable is connected, the Wi-Fi function may be disabled.
- For using stream audio via AirPlay, you can set up a network connection using Apple Home app.

# Wireless LAN connection

## ■ Preparation

- ① Disconnect the AC mains lead.
- ② Disconnect the LAN cable.
- ③ Place this unit as close to the wireless router as possible.
- ④ Connect the AC mains lead to this unit. (⇒ 26)

### Note

- The setting will be cancelled after the set time limit. In that case, try the setting again.
- To cancel this setting in the middle, press [■] or turn the unit to standby mode.
- When the connection is established, "📶" is displayed.

## Network setting for the first time using the Google Home app

- 1 Press [⏻] to turn this unit on.**
  - "Wi-Fi Setup" is displayed.
- 2 Press [▲], [▼] to select "Yes" and then press [OK].**
- 3 Open the Google Home app and follow the on-screen instructions. (⇒ 31)**

### Note

- This unit will be displayed as "Technics-SA-C100-\*\*\*\*" if the device name is not set. ("\*\*\*\*" stands for characters unique to each set.)
- You can check your network information (SSID, MAC address and IP address) from the Google Home app or "Technics Audio Center" app.
- Some items on the Google Home app are irrelevant to this unit.
- When this unit is switched to standby mode and turned on before the Wi-Fi setting is complete, "Wi-Fi Setup" is displayed. Set "Wi-Fi Menu" to "Off" to turn off the display.
- For using stream audio via AirPlay, you can set up a network connection using Apple Home app.

Setting the network from the setup menu

- 1 Press [**>SELECT<**] to select “Google Cast”.
- 2 Press [**SETUP**].
- 3 Press [**▲**], [**▼**] repeatedly to select “Network” and then press [**OK**].
  - When “Wi-Fi Menu” screen is displayed, press [**OK**].
- 4 Press [**▲**], [**▼**] to select “On” and then press [**OK**]. (The wireless LAN function is enabled.)
- 5 Press [**▲**], [**▼**] to select “Wi-Fi Setup” and then press [**OK**].
  - “Setting” is displayed.
- 6 Open the Google Home app and follow the on-screen instructions. (As follows)

#### ■ Using the Google Home app “Wi-Fi Setup”

(When using Google Cast-enabled apps with this unit)

You can set up a connection using the Google Home app.

- 1 **Open the Google Home app and follow the on-screen instructions to set up a connection.**
  - When the connection is established, “Success” is displayed.
    - “Fail” may be displayed if the connection was not complete. Try this method again from the setup menu. If “Fail” is still displayed, try other methods.
- 2 **Press [**OK**] to exit the setting.**

#### Note

- This unit will be displayed as “Technics-SA-C100-\*\*\*\*” if the device name is not set. (“\*\*\*\*” stands for characters unique to each set.)
- You can check your network information (SSID, MAC address and IP address) from the Google Home app or “Technics Audio Center” app.
- Some items on the Google Home app are irrelevant to this unit.
- For using stream audio via AirPlay, you can set up a network connection using Apple Home app.

## Streaming music over the network

This unit is compatible with Google Cast-enabled apps. For detailed information of Google Cast-enabled apps, visit:

[g.co/cast/apps](http://g.co/cast/apps)

You can also stream music files from the device on your network to this unit by using the free app "Technics Audio Center". Download and install the app from the website below.

[www.technics.com/support/](http://www.technics.com/support/)

And, you can also stream music over AirPlay.

### ■ Preparation

- Complete the network settings. (⇒ 27)  
(Make sure that the network is connected to the Internet.)
- Install the supported application on your device.
- Connect the device to the network currently used at home.

- 1 Open a Google Cast-enabled app, AirPlay-enabled app (⇒ 66) or "Technics Audio Center" app on your device (smartphone, tablet, etc.), and select this unit as the output speaker.**
- 2 Play back the music.**

Not all music streaming services are available in all countries/regions. Registration/subscription may be required, or fees may be charged to use music streaming services. Services are subject to change or be discontinued. For details, visit an individual music streaming service's website.

### **Important notice:**

Before you dispose of or transfer this unit to a third party, be sure to log out of your music streaming services accounts to prevent unauthorised use of your accounts.



## This unit's name on the network "Friendly Name"

You can change this unit's name on the network (e.g. "Room 1" or "Living Room" etc.).

- 1 Press [SETUP].
- 2 Press [▲], [▼] repeatedly to select "Network" and then press [OK].
- 3 Press [▲], [▼] repeatedly to select "Friendly Name" and then press [OK].
  - The current name of this unit is displayed. Press [OK] to edit.
- 4 Press [▲], [▼], [◀], [▶] to input the friendly name.
  - Only ASCII characters can be used.
  - "A" can be added when you press the [▶] at the time of the last letter of the Friendly Name is selected.
  - Press [CLEAR] to delete a letter.
  - Press [≥10] to insert a letter "A".
  - Default name is "Technics-SA-C100-\*\*\*\*". "\*\*\*\*" stands for a number that is unique to each set.
- 5 Press [OK] to apply the settings.
- 6 Press [RETURN] to exit the settings.
  - When Friendly Name is not displayed properly, delete and input the friendly name again. If the problem still persists, restore all the settings to the factory defaults. (⇒ 102)

## To check the MAC address of this unit "MAC Address"

- 1 Press [SETUP].
- 2 Press [▲], [▼] repeatedly to select "Network" and then press [OK].
- 3 Press [▲], [▼] repeatedly to select "MAC Address" (Wired/Wireless) and then press [OK].
  - The MAC address of this unit is displayed.
- 4 Press [RETURN] to exit the screen.

# Operations

<b>Playing back CDs</b> .....	<b>37</b>
Operations during playback .....	38
Repeat playback "Repeat" .....	39
Random playback "Random" .....	39
Programme playback "PGM" .....	40
<b>Listening to DAB/DAB+</b> .....	<b>41</b>
Storing DAB/DAB+ stations .....	41
Listening to the stored DAB/DAB+ stations .....	41
Presetting DAB/DAB+ stations.....	42
Listening to preset DAB/DAB+ stations .....	42
Listening to the secondary service .....	42
Display .....	43
Automatic clock adjustment.....	43
Manually tuning .....	44
Checking the DAB/DAB+ signal reception quality .....	44
<b>Listening to FM Radio</b> .....	<b>45</b>
Storing FM stations .....	45
Listening to a preset FM channel.....	45
Manual tuning and presetting .....	46
For reducing noisy sound .....	46
Radio Data System broadcasting.....	46
<b>Using Bluetooth®</b> .....	<b>47</b>
Bluetooth® transmission mode .....	48
Operations during playback .....	49
Disconnecting a Bluetooth® device.....	49
<b>Using USB device</b> .....	<b>50</b>
Operations during playback .....	51
Repeat playback "Repeat" .....	51
Random playback "Random" .....	52
Add a track to playlist.....	52
Calling up the playlist .....	52
Deleting the track from playlist .....	53

<b>Using digital audio output device .....</b>	<b>54</b>
<b>Using analogue audio output device (LINE/PHONO).....</b>	<b>56</b>
Using PHONO cable/analogue audio cable.....	57
Switching a phase of record to play.....	57
<b>Playing back music files on the media server .....</b>	<b>58</b>
Playing back content stored on the media server by controlling it from this unit .....	59
Operations during playback .....	59
Repeat playback "Repeat" .....	60
Random playback "Random" .....	60
Operations using the dedicated app "Technics Audio Center" .....	60
Playing back content stored on the media server by controlling it from a DMC .....	61
<b>Playing back Internet Radio and Podcasts.....</b>	<b>62</b>
Operations during playback .....	63
Repeat playback "Repeat" .....	63
Random playback "Random" .....	63
Adding a station to favourite list "Add Favourites" .....	64
Call up the favourite station .....	64
Deleting the favourite station "Delete Favourites" .....	64
Operations using the dedicated app "Technics Audio Center" .....	65
<b>Using AirPlay .....</b>	<b>66</b>
Operations during playback .....	67
<b>Playing audio using Spotify Connect.....</b>	<b>68</b>
<b>Using TIDAL.....</b>	<b>69</b>
Operations during playback .....	70
Repeat playback "Repeat" .....	70
Random playback "Random" .....	71
Adding a track/album/artist, etc. to favourite list "Add Favourites" .....	71
Call up the favourite track/album/artist .....	71
Deleting the favourite track/album/artist "Delete Favourites" .....	72
Operations using the dedicated app "Technics Audio Center" .....	72

<b>Using Deezer .....</b>	<b>73</b>
Operations during playback .....	74
Repeat playback "Repeat" .....	74
Random playback "Random" .....	75
Adding a track/album/artist, etc. to favourite list "Add Favourites" .....	75
Call up the favourite track/album/ artist .....	75
Deleting the favourite track/album/ artist "Delete Favourites" .....	76
Operations using the dedicated app "Technics Audio Center" .....	76
<b>Using Amazon Music .....</b>	<b>77</b>
Operations during playback .....	78
Repeat playback "Repeat" .....	78
Random playback "Random" .....	79
Operations using the dedicated app "Technics Audio Center" .....	79
<b>Using Qobuz.....</b>	<b>80</b>
Operations during playback .....	81
Repeat playback "Repeat" .....	81
Random playback "Random" .....	82
Adding a track/album/artist, etc. to favourite list "Add Favourites" .....	82
Call up the favourite track/album/ artist .....	82
Deleting the track/album/artist "Delete Favourites" .....	83
Operations using the dedicated app "Technics Audio Center" .....	83
<b>Listening to music using Google Cast-enabled app.....</b>	<b>84</b>

 Table of contents ... 04

## Playing back CDs

Insert the CD for music playback.

- Refer to "Notes on CDs" (⇒ 112) for the discs this unit can play back.

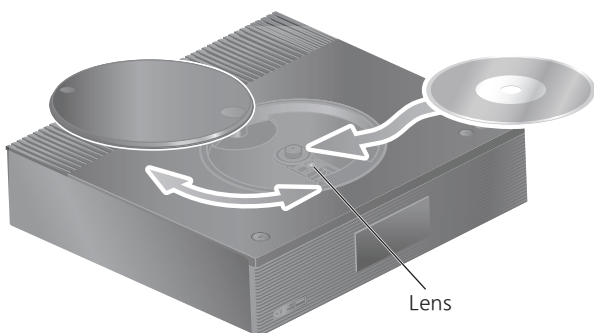

**1 Press [⏻] to turn this unit on.**

**2 Press [CD].**

**3 Open the top cover with a sliding motion and then insert the CD.**

- The top cover can slide to the both sides.
- Place the CD with its label facing up, and push the centre of the CD until a clicking sound is heard.

**4 Close the top cover with a sliding motion.**

- This unit cannot play back the CD while the top cover is open.

**5 Press [▶/⏸].**

### ■ To eject the CD

- ① Open the top cover with a sliding motion.
- ② Eject the CD.



- Be careful not to hit the CD with the top cover.
- Eject the CD after the CD has stopped turning.

## Note

- Be careful not to get your finger caught in the top cover when opening/closing it.
- Do not apply too much force to the top cover when sliding it. Doing so may cause malfunction.
- Do not leave the top cover open for a prolonged period. Doing so will cause the lens to become dirty.
- Be careful not to touch the lens with your fingers.
- The lens lights when the following operations are performed with no CD inserted. This is not a malfunction.
  - When turning the power on
  - When selecting “CD” as the input source
  - When opening and closing the top cover

## Operations during playback

<b>Stop</b>	[■]
<b>Pause</b>	[▶/  ] • Press again to resume.
<b>Skip</b>	[⏮] [⏭]
<b>Search</b>	Press and hold [⏮] or [⏭].
<b>View available information</b>	[INFO] • Press repeatedly to switch the information.

## Repeat playback

### “Repeat”

- 1 Press [MENU].
- 2 Press [▲], [▼] repeatedly to select “Repeat” and then press [OK].
- 3 Press [▲], [▼] to select an item and then press [OK].

#### 1-Track:

Repeatedly plays only the selected track. (“1↻” is displayed.)

#### All:

All tracks are repeated. (“↻” is displayed.)

- Setting contents are stored even when the input source is switched.

## Random playback

### “Random”

- 1 Press [MENU].
- 2 Press [▲], [▼] repeatedly to select “Random” and then press [OK].
- 3 Press [▲], [▼] to select “On” and then press [OK].

- “RND” is displayed.
- Setting contents are stored even when the input source is switched.
- During random playback, you cannot skip to the previous track.

# Programme playback

## “PGM”

### 1 Press [PGM] in the stop mode.

- “Program Mode” screen is displayed.

### 2 Press the numeric buttons to select tracks.

- Repeat this step to make further selections.

### 3 Press [▶/II] to start playback.

<b>Stop</b>	Press [■]. • Programmed contents are stored.
<b>Check the programmed order</b>	Press [◀] or [▶] in the stop mode.
<b>Add tracks</b>	Do step 2 in the stop mode.
<b>Clear the last track</b>	Press [CLEAR] in the stop mode. • You cannot select and clear a desired programmed track.

- Press [PGM] in the stop mode to cancel the programme mode, and the programme memory will be stored.
- To cancel the programme mode (The programme memory will be cleared.)
  - ① Press [■] in the stop mode.
  - ② Press [▲], [▼] to select “Yes” and then press [OK].

#### Note

- The programme memory is cleared when replacing the CD.
- The programme mode is cancelled when the random playback is set.



## Listening to DAB/DAB+

Make sure that the DAB antenna is connected. (⇒ 23)

### Storing DAB/DAB+ stations

To listen to DAB/DAB+ broadcasts, the available stations need to be stored in this unit.

- This unit will automatically start scanning and store the stations available in your region if the memory is empty.

**1 Press [RADIO] to select "DAB/DAB+".**

**2 "Auto Scan" starts automatically.**

- "Scan Failed" is displayed if the auto scan is unsuccessful. Locate the position with the best reception (⇒ 23) and then re-scan DAB/DAB+ stations.

#### ■ To re-scan DAB/DAB+ stations

When new stations are added or when the antenna has been moved, perform the auto scan again.

**1 Press [MENU].**

**2 Press [▲], [▼] repeatedly to select "Auto Scan" and then press [OK].**

**3 Press [▲], [▼] to select "Yes" and then press [OK].**

### Listening to the stored DAB/DAB+ stations

**1 Press [MENU].**

**2 Press [▲], [▼] repeatedly to select "Tuning Mode" and then press [OK].**

**3 Press [▲], [▼] to select "Station" and then press [OK].**

**4 Press [◀], [▶] to select the station.**

- You can also select the preset stations by pressing the numeric buttons.

## Presetting DAB/DAB+ stations

You can preset up to 20 DAB/DAB+ stations.

**1 Press [RADIO] to select "DAB/DAB+".**

**2 Press [PGM] while listening to a DAB broadcast.**

**3 Press [◀◀], [▶▶] to select the desired preset channel, and then press [PGM].**

- Presetting is not available when the station is not broadcasting or when the secondary service is selected.
- The station occupying a channel is erased if another station is preset in that channel.

## Listening to preset DAB/DAB+ stations

**1 Press [MENU].**

**2 Press [▲], [▼] repeatedly to select "Tuning Mode" and then press [OK].**

**3 Press [▲], [▼] to select "Preset" and then press [OK].**

**4 Press [◀◀], [▶▶] to select the station.**

- You can also select the preset stations by pressing the numeric buttons.
- To select the station by preset, make sure that the station has already been preset manually.

## Listening to the secondary service

Some DAB/DAB+ stations provide a secondary service as well as the primary service. If the station you are listening to is providing a secondary service, "▼" will be displayed.

**1 Press [MENU].**

**2 Press [▲], [▼] repeatedly to select "Secondary" and then press [OK].**

**3 Press [▲], [▼] to select "DAB Secondary" and then press [OK].**

- The setting will be restored to the primary service when changes are made (e.g. The station is changed).

## Display

The information switches on the display when pressing [INFO] each time.

**Dynamic label:**

Information about the broadcast

**PTY display:**

Programme type

**Ensemble label:**

Name of the ensemble

**Frequency display:**

The frequency block and frequency are displayed.

**Station name:**

Name of the broadcasting station

## Automatic clock adjustment

If the DAB broadcast includes time information, this unit's clock will be automatically updated.

- 1 Press [MENU].
  - 2 Press [▲], [▼] repeatedly to select "Auto CLOCK Adj" and then press [OK].
  - 3 Press [▲], [▼] to select "On" and then press [OK].
- Select "Off" to turn off the automatic clock adjustment function.

## Manually tuning

If “Scan Failed” is displayed after “DAB/DAB+” is selected or after an auto scan, use this function to scan a frequency block.

### ■ Preparation

- Note down a frequency block that can be received in your region (e.g., 12B 225.648 MHz).
- Adjust the position of the DAB antenna.

**1 Press [MENU].**

**2 Press [▲], [▼] repeatedly to select “Manual Scan” and then press [OK].**

**3 Press [▲], [▼] to select the frequency block that is receivable in your region and then press [OK].**

- If “Scan Failed” is still displayed, repeat steps 1 to 3 until a station is stored. If the situation does not improve, use an outdoor DAB antenna or consult your dealer.

## Checking the DAB/DAB+ signal reception quality

**1 Press [MENU].**

**2 Press [▲], [▼] repeatedly to select “Signal Quality” and then press [OK].**

- The current frequency block is displayed and then the reception quality is indicated.
- Reception quality: 0 (poor) – 8 (excellent)

**3 If the signal reception quality is poor, move the antenna to a position where the reception quality improves.**

**4 (To continue checking the quality of other frequency blocks:)**

**Press [▲], [▼] again and select the desired frequency.**

**5 Press [OK] to exit.**

- If the antenna has been adjusted, perform the auto scanning and update the station memory.

## Listening to FM Radio

Make sure that the antenna is connected.  
(⇒ 23)

### Storing FM stations

You can preset up to 30 channels.

- A station previously stored is overwritten when another station is selected for the same channel by presetting.

- 1 Press [RADIO] repeatedly to select "FM".**
- 2 Press [MENU].**
- 3 Press [▲], [▼] repeatedly to select "Auto Preset" and then press [OK].**
- 4 Press [▲], [▼] to select an item and then press [OK].**

#### **Lowest:**

To begin the auto preset with the lowest frequency (FM 87.50).

#### **Current:**

To begin the auto preset with the current frequency.

- The tuner starts to preset all the stations it can receive into the channels in ascending order.
- The factory default is "Lowest".

### Listening to a preset FM channel

- 1 Press [MENU].**
- 2 Press [▲], [▼] repeatedly to select "Tuning Mode" and then press [OK].**
- 3 Press [▲], [▼] to select "Preset" and then press [OK].**
- 4 Press [◀◀], [▶▶] or numeric buttons to select the channel.**

## Manual tuning and presetting

- 1 Press [MENU].
- 2 Press [▲], [▼] repeatedly to select "Tuning Mode" and then press [OK].
- 3 Press [▲], [▼] to select "Manual" and then press [OK].
- 4 Press [◀◀], [▶▶] to tune to the required station.

To start automatic tuning, press and hold [◀◀] or [▶▶] until the frequency starts scrolling. Tuning stops when a station is found.

### ■ To preset the channel

- ① While listening to the radio broadcast, press [PGM].
- ② Press [◀◀] or [▶▶] to select the channel and then press [PGM].

## For reducing noisy sound

- 1 Press [MENU].
  - 2 Press [▲], [▼] repeatedly to select "FM Mode" and then press [OK].
  - 3 Press [▲], [▼] to select "Mono" and then press [OK].
- Select "Auto(Stereo)" in step 3 to return to stereo broadcasts.
  - "Mono" is cancelled if the frequency is changed.

## Radio Data System broadcasting

The unit can display the text data transmitted by the radio data system available in some areas.

### Note

- Radio Data System is available only when stereo works in reception.
- Radio Data System displays may not be available if reception is poor.

## Using Bluetooth®

You can listen to the sound from the Bluetooth® audio device from this unit wirelessly.

- Refer to the operating instructions of the Bluetooth® device for details.



Bluetooth® device

### ■ Pairing a Bluetooth® device

- Turn on the Bluetooth® feature of the device and place the device near this unit.
- If a Bluetooth® device is already connected, disconnect it. (⇒ 49)

#### 1 Press [**Bluetooth-PAIRING**].

- When “Pairing” is indicated on the display, proceed to step 5.
- By pressing and holding [**Bluetooth-PAIRING**] this unit starts waiting for registering. Proceed to step 5.

#### 2 Press [**MENU**].

#### 3 Press [**▲**], [**▼**] repeatedly to select “Pairing” and then press [**OK**].

#### 4 Press [**▲**], [**▼**] to select “Yes” and then press [**OK**].

- “Pairing” is displayed, and this unit waits for registering.

#### 5 Select “Technics-SA-C100-\*\*\*\*” from the Bluetooth® device’s menu.

- The name of the connected device is indicated on the display.
- The MAC address “\*\*\*\*” (“\*\*\*\*” stands for a character that is unique to each set.) may be displayed before “Technics-SA-C100-\*\*\*\*” is displayed.
- If the device name is set on the Google Home app, the set name is displayed.

### Note

- You can also enter pairing mode by pressing and holding [Ⓜ-PAIRING] when the input source is "Bluetooth".
- If prompted for the passkey, input "0000".
- You can register up to 8 devices with this unit. If a 9th device is paired, the device that has not been used the longest may be replaced.
- While "Standby Mode" is set to "On" (⇒ 96), this unit automatically turns on when a Bluetooth® connection is established to this unit from a paired Bluetooth® device.

### ■ Listening to music stored on a Bluetooth® device

#### 1 Press [Ⓜ-PAIRING].

- "Ready" or "Pairing" is indicated on the display.

#### 2 Select "Technics-SA-C100-\*\*\*\*" from the Bluetooth® device's menu.

- The name of the connected device is indicated on the display.
- If the device name is set on the Google Home app, the set name is displayed.

#### 3 Start playback on the Bluetooth® device.

### Note

- This unit can only be connected to one device at a time.
- When "Bluetooth" is selected as the input source, this unit will automatically try and connect to the last connected Bluetooth® device. ("Linking" is displayed during this process.)

## Bluetooth® transmission mode

#### 1 Press [Ⓜ-PAIRING].

- If a Bluetooth® device is already connected, disconnect it.

#### 2 Press [MENU].

#### 3 Press [▲], [▼] repeatedly to select "Link Mode" and then press [OK].

#### 4 Press [▲], [▼] to select the mode and then press [OK].

#### Mode1:

Emphasis on connectivity

#### Mode2:

Emphasis on sound quality (default)

### Note

- Select "Mode1" if the sound is interrupted.



## Operations during playback

Stop	■
Pause	▶/   • Press again to resume.
Skip	⏮ ⏭
Search	Press and hold [⏮] or [⏭].

### Note

- To use this unit's remote control/touch switches with a Bluetooth® device, the Bluetooth® device must support AVRCP (Audio Video Remote Control Profile). Depending on the status of the device, some controls may not work.
- When enjoying video contents with this function, the video and audio output may not be synchronised.

## Disconnecting a Bluetooth® device

- 1 Press [MENU].
- 2 Press [▲], [▼] repeatedly to select "Disconnect?" and then press [OK].
- 3 Press [▲], [▼] to select "Yes" and then press [OK].

### Note

- The Bluetooth® device will be disconnected if a different audio source is selected.

## Using USB device

You can connect a USB device to the unit and play back music stored on the USB device.

- Refer to “USB” (⇒ 113) for information about the USB device this unit can play back.

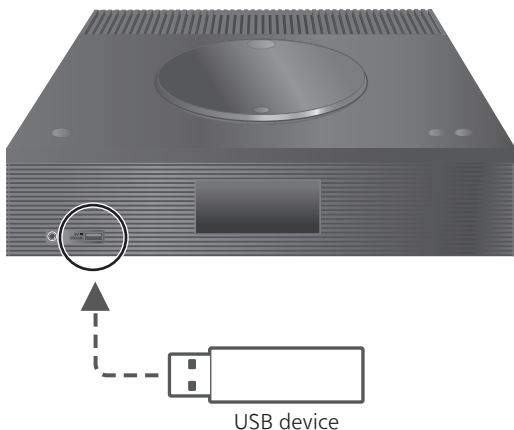

### 1 Connect a USB device to the unit.

- Depending on a thickness of USB device, you may not connect USB device while LAN cable is connected.

### 2 Press [**>SELECT<**] repeatedly to select “USB”.

- The folder/content selection screen will be displayed.

### 3 Press [**▲**], [**▼**] to select an item and then press [**OK**].

- Repeat this step to make further selections.
- Press [**RETURN**] to return to the previous folder.

## Operations during playback

<b>Stop</b>	[■]
<b>Pause</b>	[▶/  ] • Press again to resume.
<b>Skip</b>	[⏮] [⏭]
<b>Search</b>	Press and hold [⏮] or [⏭].
<b>View available information</b>	[INFO] • Press repeatedly to switch the information.

- This operation may not be available for some formats.

## Repeat playback

### “Repeat”

- 1 Press [MENU].
- 2 Press [▲], [▼] repeatedly to select “Repeat” and then press [OK].
- 3 Press [▲], [▼] to select an item and then press [OK].

#### 1-Track:

Repeatedly plays only the selected track. (“1↻” is displayed.)

#### All:

All tracks in the folder are repeated. (“↻” is displayed.)

- Setting contents are stored even when the input source is switched.

## Random playback

### “Random”

- 1 Press [MENU].
  - 2 Press [▲], [▼] repeatedly to select “Random” and then press [OK].
  - 3 Press [▲], [▼] to select “On” and then press [OK].
- “RND” is displayed.
  - All tracks may not be played back. Set the repeat playback (“All”).
  - Setting contents are stored even when the input source is switched.

## Add a track to playlist

You can add your favourite track to playlist.

- 1 Press [▲], [▼] to select a track to add.
  - 2 Press [MENU].
  - 3 Press [▲], [▼] to select “Add to Playlist” and then press [OK].
- “Added” is displayed after adding.
  - You can add up to 1000 tracks to playlist.

### Note

- The playlist cannot be played back properly with the other USB device except the registered one. When the contents of USB device is changed or another USB device is connected, delete all tracks and add them again.
- The setting is deleted when AC mains lead is disconnected. It may also be deleted when this unit is turned off while “Standby Mode” is set to or “Off”.

## Calling up the playlist

- 1 Press [▲], [▼] to select “Playlist” and then press [OK].
  - Press [RETURN] to return to the previous folder.
- 2 Press [▲], [▼] to select a track and then press [OK].

## Deleting the track from playlist

- 1 Press [▲], [▼] to select "Playlist" and then press [OK].**
  - Press [RETURN] to return to the previous folder.
- 2 Press [▲], [▼] to select a track to delete.**
- 3 Press [MENU].**
- 4 Press [▲], [▼] to select "Delete One" and then press [OK].**
  - Select "Delete All" and press [OK] to delete all tracks from playlist.
  - "Deleted" is displayed after deleting.
  - "Empty" is displayed if no track is registered to the playlist.

## Using digital audio output device

You can connect a DVD player, etc. with coaxial digital cable (not supplied)/optical digital audio cable (not supplied) and play back music.

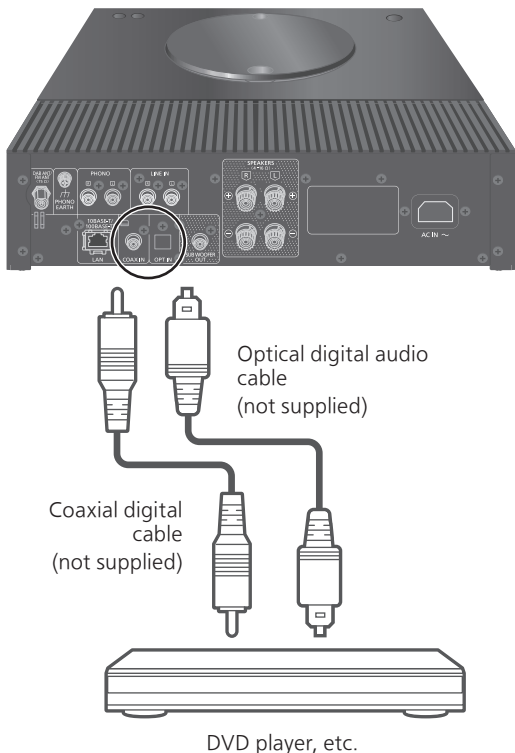

- 1 Disconnect the AC mains lead.
- 2 Connect this unit and a DVD player etc.
- 3 Connect the AC mains lead to this unit.  
(⇒ 26)
- 4 Press [⏻] to turn this unit on.
- 5 Press [>SELECT<] repeatedly to select "COAX"/"OPT".
- 6 Start playback on the connected device.

**Note**

- The digital audio input terminal of this unit can only detect the following linear PCM signals. For details, refer to the operating instructions of the connected device.
  - Sampling frequency:
    - Coaxial digital input  
32/44.1/48/88.2/96/176.4/192 kHz
    - Optical digital input  
32/44.1/48/88.2/96 kHz
  - Number of quantisation bits:  
16/24 bit

# Operations

## Using analogue audio output device (LINE/PHONO)

You can connect the turntable with PHONO cable (not supplied) or the Blu-ray Disc player, etc. with analogue audio cable (not supplied) to this unit and play back music.

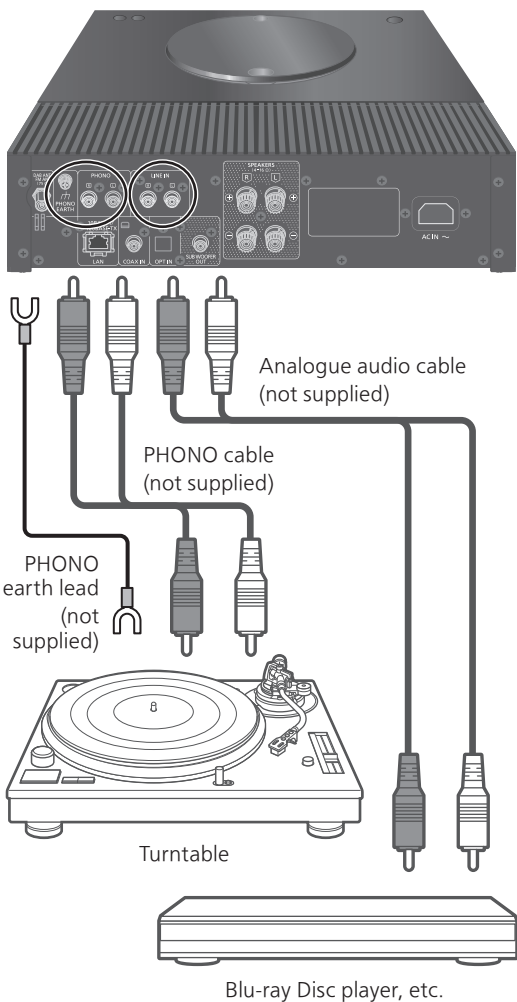



## Using PHONO cable/ analogue audio cable

- 1 Disconnect the AC mains lead.**
- 2 Connect this unit and a device.**
- 3 Connect the AC mains lead to this unit.**  
(⇒ 26)
  - Turn the volume down before switching the input source.
- 4 Press [>SELECT<] repeatedly to select "LINE"/"PHONO".**
- 5 Start playback on the connected device.**

### Note

- When connecting a turntable with a built-in PHONO equalizer, turn the equalizer of turntable off or connect the PHONO cable to the analogue audio input terminals (LINE) of this unit.
- When connecting a turntable with a PHONO earth lead, connect the PHONO earth lead to the PHONO EARTH terminal of this unit.

## Switching a phase of record to play

Sets to play back and enjoy the inverted phase audio.

- The factory default is "Normal".

- 1 Press [MENU].**
- 2 Press [▲], [▼] repeatedly to select "Phase" and then press [OK].**
- 3 Press [▲], [▼] to select "Normal" / "Invert" and then press [OK].**
  - While setting to "Invert", "INV" is displayed.

# Playing back music files on the media server

You can share music files stored in the media server (PC, Network Attached Storage, etc.) connected to your home network, and enjoy the contents with this unit.

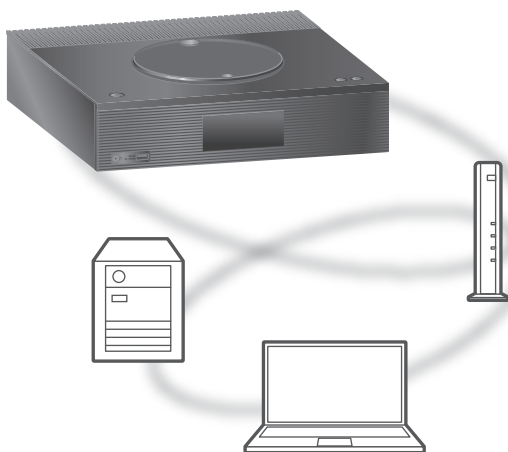

### ■ Preparation

- Complete the network settings. (⇒ 27)
- Connect the device to be used to the network of this unit.
- To use Windows Media® Player
  - Add the contents and folder to the libraries of the Windows Media® Player 11 or 12, or a smartphone, etc.
  - Playlist of Windows Media® Player can playback only the contents that are stored in the libraries.
  - To use Windows Media® Player for streaming, you need to configure it in advance.

Playing back content stored on the media server by controlling it from this unit

- 1 Press [>SELECT<] repeatedly to select "DMP".**
  - The server selection screen will be displayed.
- 2 Press [▲], [▼] to select a media server on the network, and then press [OK].**
  - The folder/content selection screen will be displayed. Repeat this step to make further selections.
  - Folders/content may be displayed in different order from the order on the server, depending on its specifications.
- 3 Press [▲], [▼] to select an item and then press [OK].**

#### Note

- The connected server and its contents may not be displayed properly depending on its condition. (e.g. soon after adding the contents to the server, etc.)  
Please try again later. For details, refer to the operating instructions of the device.

## Operations during playback

<b>Stop</b>	[■]
<b>Pause</b>	[▶/  ] • Press again to resume.
<b>Skip</b>	[◀◀] [▶▶]
<b>Search</b>	Press and hold [◀◀] or [▶▶].
<b>View available information</b>	[INFO] • Press repeatedly to switch the information.

## Repeat playback

### “Repeat”

- 1 Press [MENU].
- 2 Press [▲], [▼] repeatedly to select “Repeat” and then press [OK].
- 3 Press [▲], [▼] to select an item and then press [OK].

#### 1-Track:

Repeatedly plays only the selected track. (“1↻” is displayed.)

#### All:

All tracks are repeated. (“↻” is displayed.)

- Setting contents are stored even when the input source is switched.

## Random playback

### “Random”

- 1 Press [MENU].
- 2 Press [▲], [▼] repeatedly to select “Random” and then press [OK].
- 3 Press [▲], [▼] to select “On” and then press [OK].

- “RND” is displayed.
- All tracks may not be played back. Set the repeat playback (“All”).
- Setting is available even when the input source is switched.

## Operations using the dedicated app

### “Technics Audio Center”

If you install the dedicated app “Technics Audio Center” (free of charge) on your tablet/smartphone, you can control this unit using a wide variety of functions.

For details, visit:

[www.technics.com/support/](http://www.technics.com/support/)

## Playing back content stored on the media server by controlling it from a DMC

By controlling a DMC (Digital Media Controller) compatible device, you can play back music stored on the media server on this unit (DMR—Digital Media Renderer).

- 1 Press [⏻] to turn this unit on.**
- 2 Operate the DMC compatible device and connect to this unit.**

- The device name of this unit will be displayed as “Technics-SA-C100-\*\*\*\*”<sup>\*1, 2</sup>.
- For details on how to use DMC compatible devices, refer to the operating instructions of the devices or the software.

### Note

- When you operate DMC, playback of other audio sources will stop and media server output will have priority.
  - Depending on the contents and the connected equipment, operations or playback may not be possible.
  - This unit does not guarantee connection with all DMC applications. Use the dedicated app “Technics Audio Center”.
- \*1: “\*\*\*\*” stands for a digit that is unique to each set.
- \*2: The device name can be changed from “This unit’s name on the network”. (⇒ 33)

## Playing back Internet Radio and Podcasts

This unit supports an audio broadcasting service transmitted via the Internet, and Internet Radio and Podcasts can be played back.

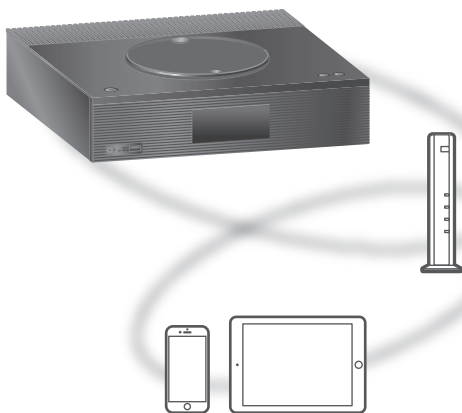

### ■ Preparation

- Complete the network settings. (⇒ 27)
  - Make sure that the network is connected to the Internet.

### 1 Press [**>**SELECT<] repeatedly to select “Internet Radio” / “Podcasts”.

- When “Internet Radio” / “Podcasts” is selected as the source, this unit will automatically try and connect to the last selected station.

### 2 Press [**▲**], [**▼**] to select a station and then press [OK].

- Repeat this step to make further selections according to the genre, region, etc.
- The station that does not broadcast cannot be played back. (It will be skipped or return to the list.)

### Note

- Internet Radio and Podcasts may be suspended or be otherwise unavailable without notice.
- Internet Radio may not be played back properly depending on the network condition.

## Operations during playback

<b>Stop</b>	[■] (Returns to the list.)
<b>Pause</b> (Podcasts)	[▶/  ] • Press again to resume.
<b>Skip</b>	[⏮] [⏭]
<b>Search</b> (Podcasts)	Press and hold [⏮] or [⏭].

## Repeat playback

### “Repeat”

- 1 Press [MENU].
- 2 Press [▲], [▼] repeatedly to select “Repeat” and then press [OK].
- 3 Press [▲], [▼] to select an item and then press [OK].

#### 1-Track:

Repeatedly plays only the selected track. (“1↻” is displayed.)

#### All:

All tracks are repeated. (“↻” is displayed.)

- Repeat playback is not available for the content of “Internet Radio”.
- Setting contents are stored even when the input source is switched.

## Random playback

### “Random”

- 1 Press [MENU].
- 2 Press [▲], [▼] repeatedly to select “Random” and then press [OK].
- 3 Press [▲], [▼] to select “On” and then press [OK].

- “RND” is displayed.
- Random playback is not available for the content of “Internet Radio”.
- All tracks may not be played back. Set the repeat playback (“All”).
- Setting is available even when the input source is switched.

## Adding a station to favourite list "Add Favourites"

You can add a station to favourite list and call up the station easily.

- 1 Press [▲], [▼] to select a station to add and then press [OK].**
  - 2 Press [MENU].**
  - 3 Press [▲], [▼] repeatedly to select "Add Favourites" and then press [OK].**
- "Added" is displayed after registering.

## Call up the favourite station

- 1 Press [▲], [▼] repeatedly to select "Favorites" and then press [OK].**
    - "Favorites" is displayed on the first layer. Press [RETURN] to return to the previous folder.
  - 2 Press [▲], [▼] to select the station and then press [OK].**
- "Empty" is displayed if no item is registered to the favourite list.

## Deleting the favourite station "Delete Favourites"

- 1 Press [▲], [▼] repeatedly to select "Favorites" and then press [OK].**
    - "Favorites" is displayed on the first layer. Press [RETURN] to return to the previous folder.
  - 2 Press [▲], [▼] to select a station to delete from the favourite list.**
  - 3 Press [MENU].**
  - 4 Press [▲], [▼] repeatedly to select "Delete Favourites" and then press [OK].**
  - 5 Press [▲], [▼] to select "Yes" and then press [OK].**
- "Deleted" is displayed after deleting.
  - "Empty" is displayed if no station is registered to the favourite list.



## Operations using the dedicated app “Technics Audio Center”

If you install the dedicated app “Technics Audio Center” (free of charge) on your tablet/smartphone, you can control this unit using a wide variety of functions.

For details, visit:

[www.technics.com/support/](http://www.technics.com/support/)

## Using AirPlay

You can play back music stored on iOS device, etc. using AirPlay.

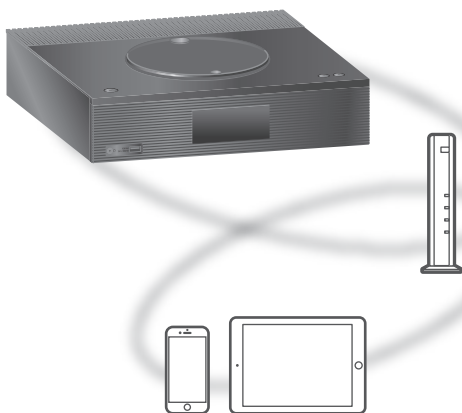

### ■ Preparation

- Complete the network settings. (⇒ 27)
- Connect the iOS device or PC to the same network as this unit.

#### 1 (iOS device)

**Start the “Music” (or iPod) app.**

(PC)

**Start “iTunes”.**

#### 2 Select “Technics-SA-C100-\*\*\*\*”<sup>\*1,2</sup> from the AirPlay icon (e.g. ).

- If the device name is set on the Google Home app, the set name is displayed.

#### 3 Start play.

- Check the volume settings before starting the playback.
- When AirPlay is used for the first time, the volume may be output at the maximum setting.
- The playback will start with a slight delay.

\*1: “\*\*\*\*” stands for a number that is unique to each set.

\*2: The device name can be changed from “This unit’s name on the network”. (⇒ 33)

#### Note

- Some operations may not be available depending on the music streaming service.

## Operations during playback

<b>Pause</b>	[■] [▶/  ] • Press [▶/  ] again to resume.
<b>Skip</b>	[⏮] [⏭]
<b>View available information</b>	[INFO] • Press repeatedly to switch the information.

- You can also operate on the connected iOS device/PC.

### Note

- Volume changes on the iOS device or iTunes will apply to this unit. (Refer to the iTunes Help for the required settings in iTunes.)
- Playback of other audio sources will stop and AirPlay output will have priority.
- With some iOS and iTunes versions, it may not be possible to restart the AirPlay playback if the selector is changed or the unit is turned to standby mode, during the AirPlay playback. In this case, select a different device from the AirPlay icon of the Music app or iTunes and then re-select this unit as the output speakers.
- AirPlay will not work when playing back videos on iTunes.

## Playing audio using Spotify Connect

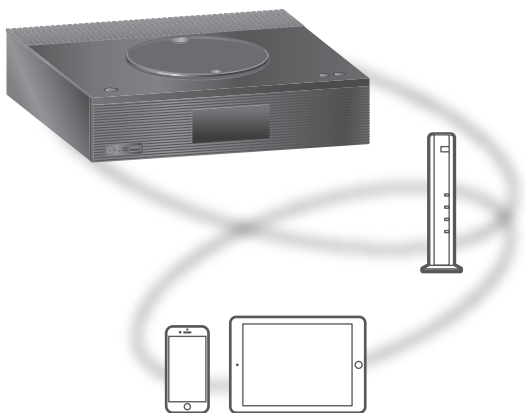

Use your phone, tablet or computer as a remote control for Spotify.

Go to [spotify.com/connect](https://spotify.com/connect) to learn how

### ■ Preparation

- Complete the network settings. (⇒ 27)
  - Make sure that the network is connected to the Internet.
- Connect the device to be used to the network of this unit.

#### Note

- The device name of this unit will be displayed as "Technics-SA-C100-\*\*\*\*"\*1, 2.
  - If the device name is set on the Google Home app, the set name is displayed.
  - Registration/subscription is required.
  - Services, icons, and specifications are subject to change.
- \*1: "\*\*\*\*" stands for a number that is unique to each set.
- \*2: The device name can be changed from "This unit's name on the network". (⇒ 33)

## Using TIDAL

You can play music from the music streaming service, TIDAL on this unit by operating the dedicated application “Technics Audio Center” (free of charge) on your smartphone, tablet, etc.

For details of TIDAL, visit the following website.

[www.tidal.com](http://www.tidal.com)

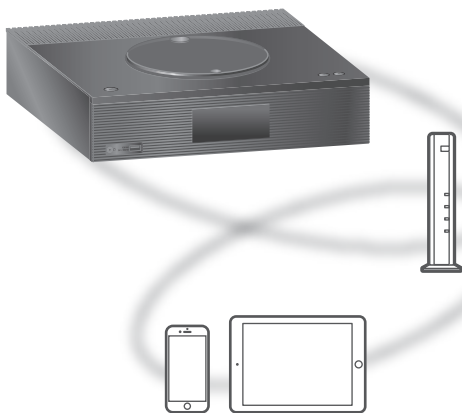

### ■ Preparation

- Install the latest “Technics Audio Center” on your device (smartphone, tablet, etc.). For details, visit: [www.technics.com/support/](http://www.technics.com/support/)
- Connect this unit and your device on which “Technics Audio Center” has been installed to the network connected to the internet. For details, refer to their operating instructions.
- When TIDAL is used for the first time, log into TIDAL. Perform the following steps for login.
  - ① Start “Technics Audio Center” on your device (smartphone, tablet, etc.).
  - ② Select “TIDAL” from “Technics Audio Center”.
  - ③ Log into TIDAL. (If you do not have an account, you need to register the account.)

## 1 Press [**>SELECT<**] repeatedly to select "TIDAL".

- When TIDAL is used for the first time, "Operate via App" is displayed. Use the dedicated app "Technics Audio Center" for operating.

## 2 Press [**▲**], [**▼**] to select an item and then press [**OK**].

- Repeat this step to make further selections.
- Press [RETURN] to return to the previous folder.
- Folders/content may be displayed in different order from the order on the connected device, depending on its specifications.

### Note

- Depending on the country or region, playback may not be available.

## Operations during playback

Stop	[■]
Pause	[▶/  ] • Press again to resume.
Skip	[◀◀] [▶▶]
Search	Press and hold [◀◀] or [▶▶].

## Repeat playback

### "Repeat"

#### 1 Press [MENU].

#### 2 Press [**▲**], [**▼**] repeatedly to select "Repeat" and then press [OK].

#### 3 Press [**▲**], [**▼**] to select an item and then press [OK].

##### 1-Track:

Repeatedly plays only the selected track. ("1↻" is displayed.)

##### All:

All tracks are repeated. ("↻" is displayed.)

- Setting contents are stored even when the input source is switched.

## Random playback

### “Random”

- 1 Press [MENU].
  - 2 Press [▲], [▼] repeatedly to select “Random” and then press [OK].
  - 3 Press [▲], [▼] to select “On” and then press [OK].
- “RND” is displayed.
  - All tracks may not be played back. Set the repeat playback (“All”).
  - Setting contents are stored even when the input source is switched.

## Adding a track/album/artist, etc. to favourite list

### “Add Favourites”

You can add a track/album/artist, etc. to favourite list and call up the content easily.

- 1 Press [▲], [▼] to select a content to add and then press [OK].
    - Repeat this step to make further selections.
    - Press [RETURN] to return to the previous folder.
    - Folders/content may be displayed in different order from the order on the connected device, depending on its specifications.
  - 2 Press [MENU].
  - 3 Press [▲], [▼] repeatedly to select “Add Favourites” and then press [OK].
- “Added” is displayed after registering.

## Call up the favourite track/album/artist

- 1 Press [▲], [▼] repeatedly to select “My Music” and then press [OK].
    - “My Music” is displayed on the first layer. Press [RETURN] to return to the previous folder.
  - 2 Press [▲], [▼] to select the content and then press [OK].
- “Empty” is displayed if no item is registered to the favourite list.

## Deleting the favourite track/ album/artist

### “Delete Favourites”

- 1 Press [▲], [▼] repeatedly to select “My Music” and then press [OK].**
  - “My Music” is displayed on the first layer. Press [RETURN] to return to the previous folder.
- 2 Press [▲], [▼] to select a content to delete from the favourite list.**
- 3 Press [MENU].**
- 4 Press [▲], [▼] repeatedly to select “Delete Favourites” and then press [OK].**
- 5 Press [▲], [▼] to select “Yes” and then press [OK].**
  - “Deleted” is displayed after deleting.
  - “Empty” is displayed if no item is registered to the favourite list.

## Operations using the dedicated app

### “Technics Audio Center”

You start the playback using “Technics Audio Center” on your tablet/smartphone.

- If you select TIDAL from “Technics Audio Center” on your tablet/smartphone, the input is automatically switched to TIDAL.
- For details, visit:  
[www.technics.com/support/](http://www.technics.com/support/)



## Using Deezer

You can play music from the music streaming service, Deezer on this unit with the dedicated application “Technics Audio Center” (free of charge) on your smartphone, tablet, etc.

For details of Deezer, visit the following website.

[www.deezer.com](http://www.deezer.com)

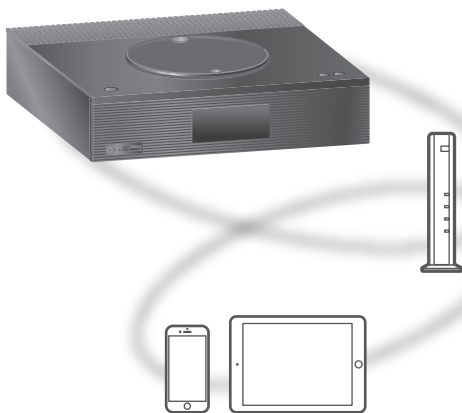

# DEEZER

### ■ Preparation

- Install the latest “Technics Audio Center” on your device (smartphone, tablet, etc.).  
For details, visit:  
[www.technics.com/support/](http://www.technics.com/support/)
- Connect this unit and your device on which “Technics Audio Center” has been installed to the network connected to the internet. For details, refer to their operating instructions.
- When Deezer is used for the first time, log into Deezer. Perform the following steps for login.
  - ① Start “Technics Audio Center” on your device (smartphone, tablet, etc.).
  - ② Select “Deezer” from “Technics Audio Center”.
  - ③ Log into Deezer. (If you do not have an account, you need to register the account.)

## 1 Press [**>SELECT<**] repeatedly to select “Deezer”.

- When Deezer is used for the first time, “Operate via App” is displayed. Use the dedicated app “Technics Audio Center” for operating.

## 2 Press [**▲**], [**▼**] to select an item and then press [**OK**].

- Repeat this step to make further selections.
- Press [RETURN] to return to the previous folder.
- Folders/content may be displayed in different order from the order on the connected device, depending on its specifications.

### Note

- Some operations may not be available depending on the music streaming service.

## Operations during playback

Stop	[■]
Pause	[▶/  ] • Press again to resume.
Skip	[◀◀] [▶▶]
Search	Press and hold [◀◀] or [▶▶].

## Repeat playback

### “Repeat”

#### 1 Press [MENU].

#### 2 Press [**▲**], [**▼**] repeatedly to select “Repeat” and then press [**OK**].

#### 3 Press [**▲**], [**▼**] to select an item and then press [**OK**].

##### 1-Track:

Repeatedly plays only the selected track. (“1↻” is displayed.)

##### All:

All tracks are repeated. (“↻” is displayed.)

- Setting contents are stored even when the input source is switched.
- Repeat playback may not be available depending on the content.

## Random playback

### “Random”

- 1 Press [MENU].
  - 2 Press [▲], [▼] repeatedly to select “Random” and then press [OK].
  - 3 Press [▲], [▼] to select “On” and then press [OK].
- “RND” is displayed.
  - All tracks may not be played back. Set the repeat playback (“All”).
  - Setting contents are stored even when the input source is switched.
  - Random playback may not be available depending on the content.

## Adding a track/album/artist, etc. to favourite list

### “Add Favourites”

You can add a track/album/artist, etc. to favourite list and call up the content easily.

- 1 Press [▲], [▼] to select a content to add and then press [OK].
    - Repeat this step to make further selections.
    - Press [RETURN] to return to the previous folder.
    - Folders/content may be displayed in different order from the order on the connected device, depending on its specifications.
  - 2 Press [MENU].
  - 3 Press [▲], [▼] repeatedly to select “Add Favourites” and then press [OK].
- “Added” is displayed after registering.

## Call up the favourite track/album/artist

- 1 Press [▲], [▼] repeatedly to select “My library” and then press [OK].
    - “My library” is displayed on the first layer. Press [RETURN] to return to the previous folder.
  - 2 Press [▲], [▼] to select the content and then press [OK].
- “Empty” is displayed if no item is registered to the favourite list.

## Deleting the favourite track/ album/artist

### “Delete Favourites”

- 1 Press [▲], [▼] repeatedly to select “My library” and then press [OK].**
  - “My library” is displayed on the first layer. Press [RETURN] to return to the previous folder.
- 2 Press [▲], [▼] to select a content to delete from the favourite list.**
- 3 Press [MENU].**
- 4 Press [▲], [▼] repeatedly to select “Delete Favourites” and then press [OK].**
- 5 Press [▲], [▼] to select “Yes” and then press [OK].**
  - “Deleted” is displayed after deleting.
  - “Empty” is displayed if no item is registered to the favourite list.

## Operations using the dedicated app

### “Technics Audio Center”

You start the playback using “Technics Audio Center” on your tablet/smartphone.

- If you select Deezer from “Technics Audio Center” on your tablet/smartphone, the input is automatically switched to Deezer.
- For details, visit:  
[www.technics.com/support/](http://www.technics.com/support/)

## Using Amazon Music

You can play music from the music streaming service, Amazon Music on this unit with the dedicated application “Technics Audio Center” (free of charge) on your smartphone, tablet, etc.

For details of Amazon Music, visit the following website.

[www.amazonmusic.com](http://www.amazonmusic.com)

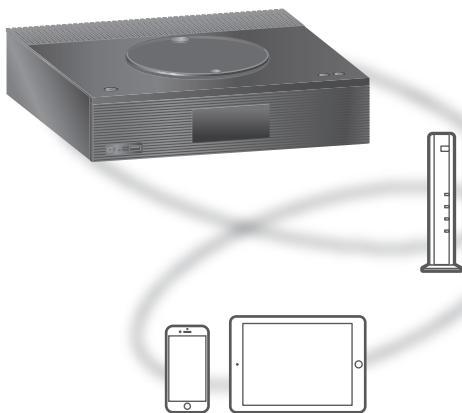

# amazon music

### ■ Preparation

- Install the latest “Technics Audio Center” on your device (smartphone, tablet, etc.).  
For details, visit:  
[www.technics.com/support/](http://www.technics.com/support/)
- Connect this unit and your device on which “Technics Audio Center” has been installed to the network connected to the internet. For details, refer to their operating instructions.
- When Amazon Music is used for the first time, log into Amazon Music. Perform the following steps for login.
  - ① Start “Technics Audio Center” on your device (smartphone, tablet, etc.).
  - ② Select “Amazon Music” from “Technics Audio Center”.
  - ③ Log into Amazon Music. (If you do not have an account, you need to register the account.)

## 1 Press [**>SELECT<**] repeatedly to select “Amazon Music”.

- When Amazon Music is used for the first time, “Operate via App” is displayed. Use the dedicated app “Technics Audio Center” for operating.

## 2 Press [**▲**], [**▼**] to select an item and then press [**OK**].

- Repeat this step to make further selections.
- Press [RETURN] to return to the previous folder.
- Folders/content may be displayed in different order from the order on the connected device, depending on its specifications.

### Note

- Some operations may not be available depending on the music streaming service.

## Operations during playback

Stop	[■]
Pause	[▶/  ] • Press again to resume.
Skip	[◀◀] [▶▶]
Search	Press and hold [◀◀] or [▶▶].

## Repeat playback “Repeat”

### 1 Press [MENU].

### 2 Press [**▲**], [**▼**] repeatedly to select “Repeat” and then press [OK].

### 3 Press [**▲**], [**▼**] to select an item and then press [OK].

#### 1-Track:

Repeatedly plays only the selected track. (“1↻” is displayed.)

#### All:

All tracks are repeated. (“↻” is displayed.)

- Setting contents are stored even when the input source is switched.
- Repeat playback may not be available depending on the content.

## Random playback

### “Random”

- 1 Press [MENU].
  - 2 Press [▲], [▼] repeatedly to select “Random” and then press [OK].
  - 3 Press [▲], [▼] to select “On” and then press [OK].
- “RND” is displayed.
  - All tracks may not be played back. Set the repeat playback (“All”).
  - Setting contents are stored even when the input source is switched.
  - Random playback may not be available depending on the content.

## Operations using the dedicated app

### “Technics Audio Center”

You start the playback using “Technics Audio Center” on your tablet/smartphone.

- If you select Amazon Music from “Technics Audio Center” on your tablet/smartphone, the input is automatically switched to Amazon Music.
- For details, visit:  
[www.technics.com/support/](http://www.technics.com/support/)

## Using Qobuz

You can play music from the music streaming service, Qobuz on this unit with the dedicated application "Technics Audio Center" (free of charge) on your smartphone, tablet, etc.

For details of Qobuz, visit the following website.

[www.qobuz.com](http://www.qobuz.com)

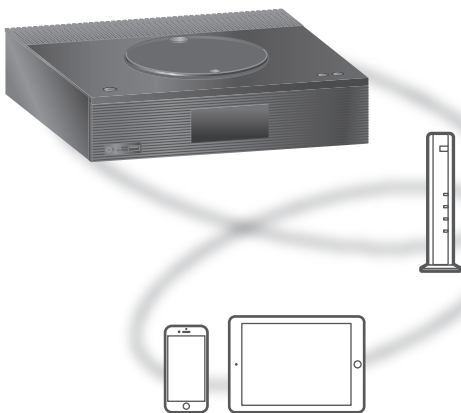

### ■ Preparation

- Install the latest "Technics Audio Center" on your device (smartphone, tablet, etc.).  
For details, visit:  
[www.technics.com/support/](http://www.technics.com/support/)
- Connect this unit and your device on which "Technics Audio Center" has been installed to the network connected to the internet. For details, refer to their operating instructions.
- When Qobuz is used for the first time, log into Qobuz. Perform the following steps for login.
  - ① Start "Technics Audio Center" on your device (smartphone, tablet, etc.).
  - ② Select "Qobuz" from "Technics Audio Center".
  - ③ Log into Qobuz. (If you do not have an account, you need to register the account.)



## 1 Press [**>SELECT<**] repeatedly to select "Qobuz".

- When "Operate via App" is displayed, use the dedicated app "Technics Audio Center" for operating.

## 2 Press [**▲**], [**▼**] to select an item and then press [**OK**].

- Repeat this step to make further selections.
- Press [RETURN] to return to the previous folder.
- Folders/content may be displayed in different order from the order on the connected device, depending on its specifications.

### Note

- Depending on the country or region, playback may not be available.

## Operations during playback

Stop	[■] (Returns to the list.)
Pause	[▶/  ] • Press again to resume.
Skip	[◀◀] [▶▶]
Search	Press and hold [◀◀] or [▶▶].

## Repeat playback "Repeat"

### 1 Press [MENU].

### 2 Press [**▲**], [**▼**] repeatedly to select "Repeat" and then press [**OK**].

### 3 Press [**▲**], [**▼**] to select an item and then press [**OK**].

#### 1-Track:

Repeatedly plays only the selected track.  
("1↻" is displayed.)

#### All:

All tracks are repeated.  
("↻" is displayed.)

- Setting contents are stored even when the input source is switched.

## Random playback

### “Random”

- 1 Press [MENU].
  - 2 Press [▲], [▼] repeatedly to select “Random” and then press [OK].
  - 3 Press [▲], [▼] to select “On” and then press [OK].
- “RND” is displayed.
  - During random playback, you may not skip to the previous track.
  - Setting contents are stored even when the input source is switched.

## Adding a track/album/artist, etc. to favourite list

### “Add Favourites”

- 1 Press [▲], [▼] to select a content to add and then press [OK].
  - Repeat this step to make further selections.
  - Press [RETURN] to return to the previous folder.
  - Folders/content may be displayed in different order from the order on the connected device, depending on its specifications.
- 2 Press [MENU].
- 3 Select “Add Favourites” and then press [OK].
  - “Added” is displayed after registering.

## Call up the favourite track/album/ artist

- 1 Press [▲], [▼] repeatedly to select “Favorites” and then press [OK].
  - “Favorites” is displayed on the first layer. Press [RETURN] to return to the previous folder.
  - Select “Playlists” to call up the favourite playlist.
- 2 Press [▲], [▼] to select the content and then press [OK].
  - “Empty” is displayed if no content is registered to the favourite list.

## Deleting the track/album/artist “Delete Favourites”

- 1 Press [▲], [▼] to select a content to delete from the favourite list.
- 2 Press [MENU].
- 3 Select “Delete Favourites” and then press [OK].
- 4 Press [▲], [▼] to select “Yes” and then press [OK].
  - “Deleted” is displayed after deleting.

## Operations using the dedicated app “Technics Audio Center”

You start the playback using “Technics Audio Center” on your tablet/smartphone.

- If you select Qobuz from “Technics Audio Center” on your tablet/smartphone, the input is automatically switched to Qobuz.
- For details, visit:  
[www.technics.com/support/](http://www.technics.com/support/)

## Listening to music using Google Cast-enabled app

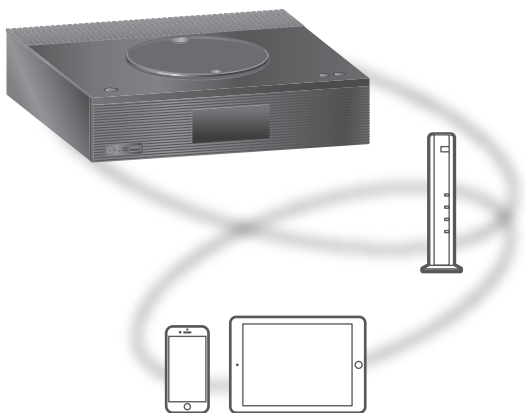

This unit is compatible with Google Cast-enabled apps. For detailed information of Google Cast-enabled apps, visit:  
[g.co/cast/apps](http://g.co/cast/apps)

### ■ Preparation

- Complete the network settings. (⇒ 27)
  - Make sure that the network is connected to the Internet.
- Install a Google Cast-enabled app on your device (smartphone, tablet, etc.).
- Connect the device to the network currently used at home.

### 1 Open a Google Cast-enabled app on your device (smartphone, tablet, etc.) and select this unit as the connecting device.

- The input source is automatically switched to “Casting”.

### 2 Play back the music.

Not all music streaming services are available in all countries/regions. Registration/subscription may be required, or fees may be charged to use music streaming services. Services are subject to change or be discontinued. For details, visit an individual music streaming service’s website.

**Important notice:**

Before you dispose of or transfer this unit to a third party, be sure to log out of your music streaming services accounts to prevent unauthorised use of your accounts.

# Settings

<b>Using the favourite function.....</b>	<b>88</b>
Registering your favourite station or playlist to [FAV] .....	88
<b>Sound adjustment .....</b>	<b>89</b>
Adjusting BASS/TREBLE " Tone Control " .....	89
Adjusting balance of speakers " Balance L/R " .....	89
Adjusting the sound quality according to the installation location " Space Tune " .....	90
Playing back more natural-sounding audio " RE-MASTER " .....	90
Sleep timer " SLEEP " .....	90
<b>Clock and Timer .....</b>	<b>91</b>
Setting the clock " CLOCK " .....	91
Play timer .....	92
<b>Other settings .....</b>	<b>94</b>
Auto off function " Auto Off " .....	94
Auto dimming function " Auto DIMMER " .....	95
Illumination on the top cover " ILLUMINATION " .....	95
Operation sound setting " Beep " .....	95
Clock display in standby mode " Standby Display " .....	95
Network standby " Standby Mode " .....	96
Switching this unit's input source automatically " OPT-IN Auto Play " .....	96
Network settings " Network " .....	96

Changing the character encoding	
“E Asian Character” .....	97
Switching clock indication	
“CLOCK Indication” .....	97
Checking the model name	
“Model No.” .....	97
Checking the firmware version	
“F/W Version” .....	97
Firmware updates	
“F/W Update” .....	98

🔄 Table of contents ... 04

## Using the favourite function

### Registering your favourite station or playlist to [FAV]

You can register your favourite station or playlist (DAB/DAB+, FM, Internet Radio, Podcasts, etc.) and call up the station easily by pressing [FAV].

- 1 Switch the input source (DAB/DAB+, FM, Internet Radio, Podcasts, etc.).**
  - 2 Press and hold [FAV] while the favourite station or playlist is played back.**
    - The registration screen is displayed.
  - 3 Press [▲], [▼] to select the number (1 - 9) to register and then press [OK].**
    - “Memorised” is displayed when the registration is completed. (Confirm that the station broadcasts if “Failed” is displayed.)
    - A station previously stored is overwritten when another station is selected for the same number.
- To cancel this setting in the middle, press [RETURN].

### Calling up the favourite station

- 1 Press [FAV].**
- 2 Press the registered number (1 - 9) and then press [OK].**
  - You can also call up the station by pressing [FAV] repeatedly. (Switches to the registered station.)
  - The input source automatically switches to the registered station.
  - “Empty” is displayed if no item is registered to the favourite list.





- 1 Press [SETUP].
- 2 Press [▲], [▼] repeatedly to select the menu and then press [OK].
- 3 Press [▲], [▼], [◀], [▶] to set, and press [OK].

### Adjusting BASS/TREBLE "Tone Control"

You can adjust the tone of this unit. Each tonal range (BASS/TREBLE) can be adjusted.

- To enable this function, select "On (adjustment)".
- Each level can be adjusted between "- 10" and "+ 10".
- "TONE" is displayed after setting.
- The factory default is "Off".

### Adjusting balance of speakers "Balance L/R"

Adjusts the balance of the output from left and right speakers.

- The audio output from the connected headphones is also adjusted.

## Adjusting the sound quality according to the installation location "Space Tune"

You can adjust the sound quality according to the installation location (near the wall or the corner of the room).

- The factory default is "Free".

### **Free:**

No objects (wall, etc.) around the speakers

### **Wall:**

There is a wall behind the speakers.

### **Corner:**

There are speakers at the corner of the room.

### **In a Shelf:**

There are speakers in the shelf.

### **L/R Custom:**

Sets the sound quality for each speaker.

### **Note**

- Using the dedicated app "Technics Audio Center" (free of charge) on your iOS device, you can measure the location between your iOS device and this unit. Set "Space Tune" to "Measured" after measuring with iOS device.  
For details, visit:  
[www.technics.com/support/](http://www.technics.com/support/)

## Playing back more natural-sounding audio "RE-MASTER"

Re-mastering expands the playback band and achieves a higher bit depth to reproduce natural and expansive sounds close to original music sources.

- The factory default is "Off".
- Depending on the content, the sound may not be re-mastered even when setting to "On".

## Sleep timer "SLEEP"

The sleep timer can turn the unit to standby mode after a set time. (30 minutes/60 minutes/90 minutes/120 minutes/Off)

- "SLEEP" is displayed after setting.
- The sleep timer always comes first. Be sure not to set an overlap of timers.



- 1 Press [SETUP].
- 2 Press [▲], [▼] repeatedly to select the menu and then press [OK].
- 3 Press [▲], [▼], [◀], [▶] to set, and press [OK].

### Setting the clock "CLOCK"

The time is displayed for 20 seconds when selecting "CLOCK". (Press [OK] to access the clock setting screen.) Press [▲], [▼] to set the time on the clock/day setting screen.

- To set the clock with the numeric buttons  
e.g.) 16:05  
[1] > [6] > [0] > [5]
- Pressing [◀], [▶] to set the day or clock type (AM/PM).

#### Note

- The clock is reset if a power failure occurs or the AC mains lead is removed.
- Set the clock regularly to maintain accuracy.
- Using the dedicated app "Technics Audio Center" (free of charge) on your tablet/smartphone, you can update the time information of this unit. For details, visit:  
[www.technics.com/support/](http://www.technics.com/support/)

## Play timer

You can set the timer so this unit turns on at a set time every day.

### ■ Preparation

- Set the clock. (⇒ 91)
- Prepare the selected music source (CD, Radio, USB device, etc.) and confirm the setting volume.
- Tune the station/channel (for radio).

### Note

- Using the dedicated app “Technics Audio Center” (free of charge) on your tablet/smartphone, you can also set the timer.  
For details, visit:  
[www.technics.com/support/](http://www.technics.com/support/)

## Setting the timer

### “Play Timer Adj.”

The current settings are displayed when selecting “Play Timer Adj.” and pressing [OK]. Press [OK] again to access the timer setting screen, and the screen starts blinking.

- ① Press [▲], [▼] or numeric buttons to set the starting time and then press [OK].
  - ② Press [▲], [▼] or numeric buttons to set the finishing time and then press [OK].
  - ③ Press [▲], [▼] to select the music source, volume, day of week and then press [OK].
- The repeating setting is as following.  
“Everyday”: Same time everyday  
“Once”: One time  
“SAT, SUN”: Every Saturday and Sunday  
“MON to FRI”: Every Monday to Friday

### ■ To display the timer settings

After setting, you can confirm the setting time, music source, etc. by selecting “Play Timer Adj.” and pressing [OK].

- You can also confirm them in standby mode by pressing [INFO].

## Turning the timer on “Play Timer Setting”

- ① Press [▲], [▼] to select “On” and then press [OK] to store the volume.
  - The clock icon is displayed.
  - “Adjust CLOCK” is displayed when the clock is not set.
  - “Adjust Play Timer” is displayed when the play timer is not set.
- ② Turn the unit to standby mode.
  - The timer is enabled after turning this unit to standby mode.
  - At the set time, the music source starts to play at a low volume and the volume increases gradually to the preset level.
  - To turn the timer off, select “Off” in step ① (above).

### Note

- This unit can be used as normal even after the timer is set, however:
  - Turn the unit to standby mode before the timer start time.
  - Even if the audio source or the volume is changed, the timer will still use the audio source and volume that was set when the timer was turned on.
- You can set the repeat playback for “CD” or “USB”. The favourite station registered by [FAV] can be also played back.
- After starting the timer, this unit is turned off automatically at the finishing time even when using this unit as normal.



- 1 Press [SETUP].
- 2 Press [▲], [▼] repeatedly to select the menu and then press [OK].
- 3 Press [▲], [▼], [◀], [▶] to set, and press [OK].

### Auto off function "Auto Off"

While the setting is set to "On", this unit automatically enters standby mode for saving energy, if no sound output without operation such as pressing buttons, etc. for approx. 20 minutes.

- When the input source is "DAB/DAB+" or "FM", this function does not work.
- The factory default is "On". To disable this function, select "Off".

#### Note

- The setting is stored even if the power is turned off and on.
- "Auto Off" is displayed 3 minutes before this unit is turned off.

## Auto dimming function

### “Auto DIMMER”

While the setting is set to “On”, this unit temporarily adjust the brightness of the display, power indicator, etc., if no sound output without operation such as pressing buttons, etc. for approx. 20 minutes.

- The factory default is “On”.

## Illumination on the top cover

### “ILLUMINATION”

The top cover illuminates when this unit is turned on. (The light of top cover turns off when the top cover is opened.)

- The factory default is “Mode2”. To disable this function, select “Off”.

#### **Mode1:**

The top cover always illuminates.

#### **Mode2:**

The top cover illuminates only when a playable CD is inserted and the input source is “CD”.

## Operation sound setting

### “Beep”

You can turn the beep sound on/off for the touch switch operation.

- The factory default is “On”. To disable this function, select “Off”.

## Clock display in standby mode

### “Standby Display”

You can set the clock display in standby mode.

#### **On (CLOCK):**

Displays the clock in standby mode.

- The clock indicator moves every certain period of time.
- When the display is turned off by pressing [DIMMER], the clock is not displayed. (The clock is displayed for several seconds when pressing [INFO].)

#### **Off:**

No display (The clock is displayed for several seconds when pressing [INFO].)

- The factory default is “Off”.

## Network standby “Standby Mode”

When this function is set to “On”, then this unit automatically turns on in the following cases.

- When a Bluetooth® connection is established to this unit from a paired Bluetooth® device.
- When playback operations are performed on this unit from a device connected to the network.
- The factory default is “On”. To disable this function, select “Off”.

## Switching this unit’s input source automatically “OPT-IN Auto Play”

Switching this unit’s input source to “OPT” automatically when the audio outputs from the device connected with optical digital input terminal.

- While setting to “On”, this unit turns on and switches the input source to “OPT” according to the audio signal from the device connected with optical digital input terminal even when this unit is in standby mode.
- The factory default is “Off”.

## Network settings “Network”

### Wi-Fi setting “Wi-Fi Menu”

The wireless LAN function can be enabled or disabled.

- The factory default is “On”.

### Displaying the network icon “Network Indicator”

Set to “Off” to turn the network icon (Wired LAN / Wireless LAN) off from the display.

- The factory default is “On”.



## Wi-Fi signal strength "Signal Level"

To check the Wi-Fi signal strength where this system is located.

- The signal strength is shown as 3 (max) - 2 - 1. If the indicator shows "2" or "1", change the position or angle of your wireless router or this system, and see if the connection improves.
- If "0" is displayed, this system cannot establish a link with the wireless router.

## Changing the character encoding "E Asian Character"

You can change the character encoding of track names, artist names and other information when they are not displayed as they should be.

### **Type 1**(日本):

Priority is given to Japanese. (default)

### **Type 2**(简体字):

Priority is given to Chinese (Simplified).

## Switching clock indication "CLOCK Indication"

You can select the clock indication type.

### **24-hour:**

24-hour clock

### **12-hour:**

12-hour clock

- The factory default is "24-hour".

## Checking the model name "Model No."

The model name is displayed.

## Checking the firmware version "F/W Version"

The version of the installed firmware is displayed.

## Firmware updates

### “F/W Update”

Occasionally, Panasonic may release updated firmware for this unit that may add or improve the way a feature operates. These updates are available free of charge.

- For the update information, refer to the following website.

[www.technics.com/support/firmware/](http://www.technics.com/support/firmware/)

**Downloading takes approx. 15 minutes.**

**Do not disconnect the AC mains lead or turn this unit to standby while updating.**

**Do not disconnect the USB flash memory while updating.**

- The progress is displayed as “Updating □ %” while updating. (“□” stands for a number.)

#### Note

- Due to measure to solve security issues, etc., there are times when operations (timers, etc.) on this system are forcibly stopped and the firmware is updated. If you do not want the firmware forcibly updated, disconnect the LAN cable or disconnect from the wireless network.
- During the update process, no other operations can be performed.
- If there are no updates, “Firmware is Up To Date” is displayed. (No need to update it.)
- Updating the firmware may reset the settings of this unit.

## Update via Internet

### ■ Preparation

- Connect this unit to the network. (⇒ 27)
  - Make sure that the network is connected to the Internet.

**1 Press [SETUP].**

**2 Press [▲], [▼] repeatedly to select “F/W Update” and then press [OK].**

**3 Press [▲], [▼] to select “Internet” and then press [OK].**

**4 Press [▲], [▼] to select “Yes” and then press [OK].**

- The progress is displayed as “Updating □ %” while updating. (“□” stands for a number.)
- When the update has finished successfully, “Success” is displayed.

**5 Press [⏻] to turn this unit off and on.**

## Update via USB flash memory

### ■ Preparation

- Download the latest firmware on the USB flash memory. For details, refer to the following website.

[www.technics.com/support/firmware/](http://www.technics.com/support/firmware/)

- 1 Connect the USB flash memory with new firmware.**
- 2 Press [SETUP].**
- 3 Press [▲], [▼] repeatedly to select “F/W Update” and then press [OK].**
- 4 Press [▲], [▼] to select “USB” and then press [OK].**
- 5 Press [▲], [▼] to select “Yes” and then press [OK].**
  - The progress is displayed as “Updating □ %” while updating. (“□” stands for a number.)
  - When the update has finished successfully, “Success” is displayed.
- 6 Press [⏻] to turn this unit off and on.**

#### Note

- Downloading may take longer depending on the USB flash memory.

# Others

<b>Troubleshooting.....</b>	<b>101</b>
Heat buildup of this unit.....	101
Do you have the latest firmware installed? .....	101
To restore all the settings to the factory defaults.....	102
General .....	102
Disc.....	104
Radio .....	104
USB.....	105
Bluetooth® .....	105
Network.....	106
Music streaming service .....	108
Remote control .....	109
Messages.....	109
<b>Playable media.....</b>	<b>112</b>
Notes on CDs .....	112
USB.....	113
<b>About Bluetooth® .....</b>	<b>114</b>
<b>Licenses.....</b>	<b>115</b>
<b>Specifications .....</b>	<b>117</b>

[↶ Table of contents ...](#) 04

## Troubleshooting

---

Before requesting service, make the following checks. If you are uncertain about some of the check points, or if the solutions indicated in the following guide do not resolve the issue, then consult your dealer for instructions.

### Heat buildup of this unit

This unit becomes warm while in use.

- Be careful when touching the bottom of this unit because the bottom of this unit may be hot. For installation or unit care, disconnect the AC mains lead, wait for at least 3 minutes.

### Do you have the latest firmware installed?

Panasonic is constantly improving the unit's firmware to ensure that our customers are enjoying the latest technology. (⇒ 98)

## To restore all the settings to the factory defaults

When the following situations occur, reset the memory:

- There is no response when buttons are pressed.
- You want to clear and reset the memory contents.

**1 Press [SETUP].**

**2 Press [▲], [▼] repeatedly to select “Initialization” and then press [OK].**

**3 Press [▲], [▼] to select “Yes” and then press [OK].**

- A confirmation screen appears. Select “Yes” in the following steps to restore all the settings to defaults.

**4 Press [▲], [▼] to select “Yes” and then press [OK] again.**

### Note

- If the setup menu cannot be entered, disconnect the AC mains lead and reconnect while pressing and holding [⏻/⏻] after approx. 3 minutes or later for restoring all the settings to the factory defaults. (“Initialized” is displayed.)

## General

**The unit does not work.**

**Operations are not done properly.**

- One of the unit’s safety devices, etc. may have been activated.
  - ① Press [⏻/⏻] on the unit to switch the unit to standby.
    - If the unit does not switch to standby, press [⏻/⏻] on the unit for at least 5 seconds. The unit is forcibly switched to standby. Alternatively, disconnect the AC mains lead, wait for at least 3 minutes, then reconnect it.
  - ② Press [⏻/⏻] on the unit to switch on. (It may take some time for this unit to be turned on.)
    - If the unit still cannot be operated, consult the dealer.
- The remote control may not work properly. (⇒ 109)

**A “humming” sound can be heard during playback.**

- An AC mains lead of another device or fluorescent light is near the cables. Turn off other appliances, or keep them away from the cables of this unit.
- A strong magnetic field near a TV or other device may adversely affect the audio quality. Keep this unit away from such a location.
- The speakers may output noise when a device nearby is emitting powerful radio waves, such as when a mobile phone is on a call.

**No sound.**

- Check the volume of this unit and the connected device.
- Check to see if the cable connections to the input and output terminals are incorrect. If this is the case, turn this unit to standby and reconnect the cables correctly.
- Check to see if the correct input source is selected.
- Insert the plugs of the cables to be connected all the way in.
- Playback of multi-channel content is not supported.
- The digital audio input terminal of this unit can only detect linear PCM signals. For details, refer to the operating instructions of the device.

**Playback does not start.**

- Depending on your environment or connected devices, it may take some time.
- Check to see if the format of the file is supported. For supported formats, refer to “File format”. (⇒ 120)

**The unit turns to standby mode automatically.**

- Is the auto off function turned on? (⇒ 94)
- This unit incorporates a protection circuit to prevent damage caused by heat buildup. When you use this unit at a high volume level for a long period of time, it may turn off automatically. Wait for this unit to cool down before turning on this unit again. (For approximately 3 minutes)

**The settings are reset to the factory defaults.**

- Updating the firmware may reset the settings.

## Disc

### **Incorrect display or play does not start.**

- Make sure that the disc is compatible with this unit. (⇒ 112)
- There is moisture on the lens. Wait for about an hour and then try again.
- Unfinalised CD-R and CD-RW cannot be played back.
- WMA/MP3 is not supported. Refer to “Notes on CDs” (⇒ 112) for information about the discs this unit can play back.

### **Playback takes time to start.**

- It may take some time for the disc to load if there are a lot of tracks on it.

## Radio

### **DAB+ reception is poor.**

- Keep the antenna away from computers, televisions, other cables and cords.
- Use an outdoor antenna (⇒ 23).

### **Static or noisy reception is heard while listening to a radio broadcast.**

- Confirm the antenna is properly connected. (⇒ 23)
- Adjust the position of the antenna.
- Keep a certain amount of distance between the antenna and AC mains lead.
- Use an outdoor antenna if there are buildings or mountains nearby. (⇒ 23)
- Turn off the TV or other audio players or separate it from this unit.
- Keep this unit away from mobile phones if there is interference.



## USB

### **The USB drive or its contents cannot be read.**

- The USB drive format or its contents is/are not compatible with the unit. (⇒ 113)

### **No response when [▶/III] is pressed.**

- Disconnect the USB device and then reconnect it. Alternatively, turn the unit to standby and on again.

### **Slow operation of the USB flash drive.**

- Large file size or high memory USB flash drive takes longer time to read.
- It may take some time if there are a lot of files or folders on it.

### **Cannot display the information properly.**

- Track names, etc. may not be displayed properly.

## Bluetooth®

### **Pairing cannot be completed.**

- Check the Bluetooth® device condition.

### **The device cannot be connected.**

- The pairing of the device was unsuccessful or the registration has been replaced. Try re-pairing the device. (⇒ 47)
- This unit might be connected to a different device. Disconnect the other device and try re-pairing the device.

### **The device is connected, but audio cannot be heard through this unit.**

- For some built-in Bluetooth® devices, you have to set the audio output to "SA-C100-\*\*\*\*" manually. Read the operating instructions for the device for details.

### **The sound is interrupted.**

- The device is out of the 10 m communication range. Bring the Bluetooth® device closer to this system.
- Remove any obstacle between this system and the device.
- Other devices that use the 2.4 GHz frequency band (wireless router, microwaves, cordless phones, etc.) are interfering. Bring the Bluetooth® device closer to this system and distance it from the other devices.
- Select "Mode1" for stable communication. (⇒ 48)

## Network

### **Cannot connect to the network.**

- Confirm the network connection and settings. (⇒ 27)
- If the network is set to be invisible, make the network visible while you set up the network for this unit or make a wired LAN connection.
- This system's Wi-Fi security supports WPA2™. Your wireless router must therefore be WPA2™ compatible. For details on the security supported by your router and how to change the settings, please refer to the operating instructions or contact your internet service provider.
- Make sure that the multicast function on the wireless router is enabled.
- The wireless LAN environment or radio interference in your area may cause connection problem. In this case, try another connection method. If the problem persists, make a wired LAN connection. (⇒ 29)
- While the AC mains lead is disconnected, the LAN cable must be connected or disconnected.

### **Cannot select this system as the output speakers.**

- Make sure that the devices are connected to the same network as this unit.
- Reconnect the devices to the network.
- Turn the wireless router off and then on.
- Turn this unit to standby and on, and then select this system as the output speakers again.

### **Playback does not start.**

#### **The sound is interrupted.**

- If using the 2.4 GHz band on the wireless router, simultaneous use with other 2.4 GHz devices, such as microwaves, cordless telephones, etc., may result in connection interruptions. Increase the distance between this unit and these devices.
  - If your wireless router supports 5 GHz band, try using the 5 GHz band.
- Do not place this system inside a metal cabinet, for it might block the Wi-Fi signal.
- If the playback stops, check the playback status on the device.
- Place this system closer to the wireless router.
- Check the Wi-Fi signal strength using “Signal Level” and adjust location of this unit and the wireless router. (⇒ 97)
- If several wireless devices are simultaneously using the same wireless network as this unit, try turning off the other devices or reducing their wireless network usage.
- Reconnect the devices to the network.
- Turn the wireless router off and then on.
- With some iOS and iTunes versions, it may not be possible to restart the AirPlay playback if the selector is changed (e.g. “CD”) or this unit is in standby mode, during the AirPlay playback. In this case, select a different device from the AirPlay icon of the Music App or iTunes and then re-select this system as the output speakers. (⇒ 66)
- If the above solutions do not solve the problem, make a wired LAN connection for all connected devices which have LAN terminal (this unit, Network Attached Storage, media server, etc.). (⇒ 29)

#### **The media server and its contents are not displayed.**

- The connected media server and its contents may not be displayed properly depending on its condition (e.g. soon after adding the contents to the server, etc.). Try again later. For details, refer to the operating instructions of the media server.

#### **Cannot find music files stored on the PC.**

- When you play back music files over a network, those that are not registered to its network server are not displayed. For details, refer to the operating instructions for your server.

#### **Cannot display the information properly.**

- Track names, etc. may not be displayed properly.

#### **The content in PC, application, etc., cannot be played back.**

- Depending on PC, application, etc., the content may not be played back even though the sampling frequency is supported. Check the PC, application, etc., to play back properly.

## Music streaming service

### **Playback does not start.**

#### **The sound is interrupted.**

- The station that does not broadcast cannot be played back. (It will be skipped or return to the list.)
- Internet Radio may not be played back properly depending on the network condition.
- Depending on the internet connection environment, the sound may be interrupted or it may take some time to play back.
- Internet Radio is an audio broadcasting service transmitted via the Internet. Depending on the broadcaster or condition of the transmitting, the sound quality may vary.
- Service may not be available depending on the country or area.
- The services through Network Service are operated by their respective service providers, and service may be discontinued either temporarily or permanently without notice.

#### **Cannot display the information properly.**

- Station names, countries, regions, genres, track names, album names, etc. which are managed by the service provider, may not be displayed properly depending on the broadcasting information.

#### **Cannot call up the stations, musics or playlists registered in favourites function (FAV).**

- The stations, musics or playlists may have been deleted or changed by the service provider. Register the station or playlist again.

#### **A content different from the registered content is played back or may not be played back normally when calling favourites function (FAV).**

- When it adds / calls a content in playlist as favourites function (FAV), a different content in playlist may be played back by the service provider.
- When it adds / calls a content as a favourites function (FAV), the title may not be displayed normally and it may not be played back normally by the service provider.

## Remote control

### **The remote control does not work properly.**

- The batteries are depleted or inserted incorrectly. (⇒ 20)
- To avoid interference, please do not put any objects in front of signal sensor. (⇒ 15)
- If the remote control mode of the remote control differs from that of this unit, match the mode of the remote control to the mode of this unit. (⇒ 20)

## Messages

### **Adjust CLOCK**

- Set the clock before setting the timer. (⇒ 91)

### **Adjust Play Timer**

- Set the starting time and finishing time of the timer. (⇒ 92)

### **Auto Off**

- The unit has been left unused for about 20 minutes and will shut down within a minute. Press any button to cancel it.

### **Checking Device**

- The unit is checking the connected USB device. After this display has disappeared, start operating.

### **Connect to Network**

- Connect this unit to the network and then wait for the start of the Firmware Update via Internet. (⇒ 98)

### **Connect USB Device**

- Download the latest firmware on the USB flash memory and try again. (⇒ 99)

### **Download Fail**

- The firmware download has failed. Press any button to exit. Please try again later.
- The server cannot be found. Press any button to exit. Make sure that the network is connected to the internet.

### **Empty**

- The selected folder is empty. Move tracks into the folder and retry the operation.
- The server is not found on the network. Check to see if the server is connected to the same network as this unit, and retry the connection to this unit. (⇒ 27)
- No Internet Radio station is registered to the favourite list. Add a station to the list. (⇒ 64)
- No station or playlist is registered to [FAV]. Add an item to the list. (⇒ 88)

## Error

- Incorrect operation is performed. Read the instructions and try again.

## Fail

- Network connection is not complete. Try the setting again. (⇒ 27)

## Firmware update is available

- The firmware (free of charge) for this unit is available.
  - ① Press [OK].
  - ② Press [▲], [▼] to select "Yes" and then press [OK].
    - The progress is displayed as "Updating □ %" while updating. ("□" stands for a number.)
    - Do not disconnect the AC mains lead or turn this unit to standby while updating. (⇒ 98)
    - When the update has finished successfully, "Success" is displayed.
  - ③ Press [⏻] to turn this unit off and on.
- For the update information, refer to the following website.  
[www.technics.com/support/firmware/](http://www.technics.com/support/firmware/)

## "F□□" ("□" stands for a number.)

- An abnormality has occurred. (If this unit detects an abnormality, the protection circuit is activated, and the power may be turned off automatically.)
  - Is this unit placed in an extremely hot place?
  - Wait a few seconds and then turn the unit on again. (The protection circuit will be deactivated.)

If the problem persists, write down the displayed number, disconnect the AC mains lead and consult your dealer.

## Load Fail

- The firmware cannot be found on the USB flash memory.
- Download the latest firmware on the USB flash memory and try again. (⇒ 99)

## No Device

- No USB device is connected.
- Connect the USB device to be played. (⇒ 50)
- The connected USB device is not supported.
- The format of the file on the USB device is not supported.
  - For supported formats, refer to "File format". (⇒ 120)

## No Disc

- No CD is inserted.
- Insert the disc to be played (⇒ 37).

## No Network Available

- This unit is not connected to the network.
- Check the network connection. (⇒ 27)

### **No Play**

- The disc cannot be played back.
- Insert the disc to be played (⇒ 112).

### **Not Valid**

- The function you have tried to use is not available with the current settings. Check the steps and settings.

### **Operate via App**

- Operation from the unit or remote control is not available.
- Use the connected device or application for operating.

### **PGM Full**

- The number of programmed tracks is more than 24.

### **Please Wait**

- This is displayed, for example, when this unit is turned to standby/on. (For up to approx. 1 minute and 30 seconds)

### **Reading**

- The unit is checking the CD information. After this display has disappeared, start operating.

### **“Remote □” (“□” stands for a number.)**

- The remote control and this unit are using different modes.  
Change the mode on the remote control. (⇒ 20)

### **Searching**

- The unit is checking the media server on the network.

### **This track is not available.**

- Some content may not be available on the music streaming service, etc.

### **Unlocked**

- “OPT” or “COAX” is selected, but no device is connected. Check the connection with the device. (⇒ 54)
- The sampling frequency components, etc. of the audio signals are not input correctly.
  - For supported formats, refer to “File format” (⇒ 120)

### **USB Over Current**

- USB device is drawing too much power.  
Disconnect the USB device and turn the unit to standby and on again. (⇒ 50)

### **Wi-Fi Setup**

- Select “Yes” and press [OK] to enter the network setting. (⇒ 30)
  - To exit the network setting, select “No” and press [OK].

## Playable media

### Notes on CDs

#### ■ Compatible CD

- A disc with the CD Logo. 
- This unit can play back discs that conform to the CD-DA format.
- The unit may not be able to play some discs due to the condition of the recording.
- Before playback, finalise the disc on the device it was recorded on.

#### ■ CDs that cannot be used

- CDs with irregular shapes, such as heart shapes (Use of such CDs may cause malfunction.)

#### ■ CDs that are not guaranteed to operate with this unit

- Discs with illegally copied data and those that do not conform to industry standards
- DualDiscs (Discs that record data such as music and images on both sides)

#### ■ Disc formats supported by this unit

Commercially available CDs (CD-DA)	Support
CD-R/CD-RW(CD-DA)	Support
CD-R/CD-RW(MP3)	Not support
CD-R/CD-RW(WMA)	Not support

#### ■ This unit's lens

Use the lens cleaner (not supplied) to clean the unit's lens.

#### ■ Clean discs

DO



DO NOT



Wipe with a damp cloth and then wipe dry with a dry cloth.

#### ■ Disc handling precautions

- Handle discs by the edges to avoid inadvertent scratches or fingerprints on the disc.
- Do not use disc cleaning sprays, benzine, thinner, static electricity prevention liquids or any other solvent.
- Do not attach labels or stickers to discs.
- Do not use the following discs:
  - Discs with exposed adhesive from removed stickers or labels (rented discs, etc.).
  - Discs that are badly warped or cracked.
  - Irregularly shaped discs, such as heart shapes.



## USB

- This unit does not guarantee connection with all USB devices.
- FAT16, FAT32 and NTFS file systems are supported.
- This unit supports USB 2.0 high speed.
- Connect a USB device with a thickness of 8 mm or less.
- USB devices may not be recognised by this unit when connected using the following:
  - a USB hub
  - a USB extension cable
- It is not possible to use USB card reader/writers.
- This unit cannot record music to a USB device.
- Not all files on the USB device may be read if there are some files not supported.
- About supported format, refer to “File format” (⇒ 120)

### ■ Folder and file structure

The unit plays back only the music files in the selected folder. Select the folder containing the tracks that you want to play back.

- Nothing is played back if you select a folder without music files, such as the folder **D** in the diagram below. (“Empty” is displayed.)

#### Example:

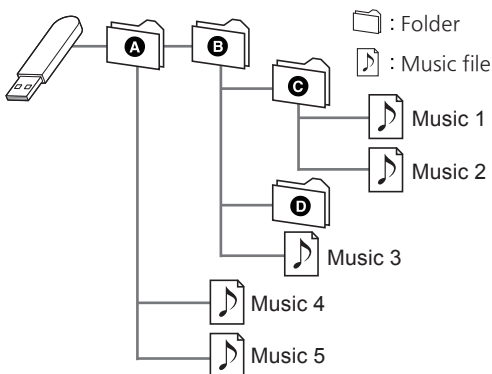

# About Bluetooth®

---

**Panasonic bears no responsibility for data and/or information that is compromised during a wireless transmission.**

### **Frequency band used**

- This system uses the 2.4 GHz frequency band.

### **Certification of this device**

- This system conforms to frequency restrictions and has received certification based on frequency laws. Thus, a wireless permit is not necessary.
- The actions below are punishable by law in some countries:
  - Taking apart or modifying the system.
  - Removing specification indications.

### **Restrictions of use**

- Wireless transmission and/or usage with all Bluetooth® equipped devices is not guaranteed.
- All devices must conform to standards set by Bluetooth SIG, Inc.
- Depending on the specifications and settings of a device, it can fail to connect or some operations can be different.
- This system supports Bluetooth® security features. But depending on the operating environment and/or settings, this security is possibly not sufficient. Transmit data wirelessly to this system with caution.
- This system cannot transmit data to a Bluetooth® device.

### **Range of use**

- Use this device at a maximum range of 10 m. The range can decrease depending on the environment, obstacles or interference.

### **Interference from other devices**

- This system may not function properly and troubles such as noise and sound jumps may arise due to radio wave interference if this system is located too close to other Bluetooth® devices or the devices that use the 2.4 GHz band.
- This system may not function properly if radio waves from a nearby broadcasting station, etc. is too strong.

### **Intended usage**

- This system is for normal, general use only.
- Do not use this system near an equipment or in an environment that is sensitive to radio frequency interference (example: airports, hospitals, laboratories, etc.).

## Licenses



The Wi-Fi CERTIFIED™ Logo is a certification mark of Wi-Fi Alliance®.



Use of the Works with Apple badge means that an accessory has been designed to work specifically with the technology identified in the badge and has been certified by the developer to meet Apple performance standards.

Apple and AirPlay are trademarks of Apple Inc., registered in the U.S. and other countries.

This product is compatible with AirPlay 2. iOS 11.4 or later is required.



Google, Google Home and Google Cast are trademarks of Google LLC.

Windows is a trademark or a registered trademark of Microsoft Corporation in the United States and other countries.

Windows Media and the Windows logo are trademarks or registered trademarks of Microsoft Corporation in the United States and/or other countries. This product is protected by certain intellectual property rights of Microsoft Corporation and third parties. Use or distribution of such technology outside of this product is prohibited without a license from Microsoft or an authorized Microsoft subsidiary and third parties.

Mac and OS X are trademarks of Apple Inc., registered in the U.S. and other countries.

The Bluetooth® word mark and logos are registered trademarks owned by Bluetooth SIG, Inc. and any use of such marks by Panasonic Holdings Corporation is under license. Other trademarks and trade names are those of their respective owners.

"DSD" is a registered trademark.

## FLAC Decoder

Copyright (C) 2000, 2001, 2002, 2003, 2004, 2005, 2006, 2007, 2008, 2009 Josh Coalson

Redistribution and use in source and binary forms, with or without modification, are permitted provided that the following conditions are met:

- Redistributions of source code must retain the above copyright notice, this list of conditions and the following disclaimer.
- Redistributions in binary form must reproduce the above copyright notice, this list of conditions and the following disclaimer in the documentation and/or other materials provided with the distribution.
- Neither the name of the Xiph.org Foundation nor the names of its contributors may be used to endorse or promote products derived from this software without specific prior written permission.

THIS SOFTWARE IS PROVIDED BY THE COPYRIGHT HOLDERS AND CONTRIBUTORS "AS IS" AND ANY EXPRESS OR IMPLIED WARRANTIES, INCLUDING, BUT NOT LIMITED TO, THE IMPLIED WARRANTIES OF MERCHANTABILITY AND FITNESS FOR A PARTICULAR PURPOSE ARE DISCLAIMED. IN NO EVENT SHALL THE FOUNDATION OR CONTRIBUTORS BE LIABLE FOR ANY DIRECT, INDIRECT, INCIDENTAL, SPECIAL, EXEMPLARY, OR CONSEQUENTIAL DAMAGES (INCLUDING, BUT NOT LIMITED TO, PROCUREMENT OF SUBSTITUTE GOODS OR SERVICES; LOSS OF USE, DATA, OR PROFITS; OR BUSINESS INTERRUPTION) HOWEVER CAUSED AND ON ANY THEORY OF LIABILITY, WHETHER IN CONTRACT, STRICT LIABILITY, OR TORT (INCLUDING NEGLIGENCE OR OTHERWISE) ARISING IN ANY WAY OUT OF THE USE OF THIS SOFTWARE, EVEN IF ADVISED OF THE POSSIBILITY OF SUCH DAMAGE.

The Spotify Software is subject to third party licenses found here: <https://www.spotify.com/connect/third-party-licenses>.

## Specifications

### ■ GENERAL

Power supply	AC 220 V to 240 V, 50/60 Hz
Power consumption	46 W
Power consumption in standby mode (Network Standby Off & No clock display)	0.2 W
Power consumption in standby mode (Network Standby On & No clock display)	2.0 W*1
Dimensions (W×H×D)	340 mm × 94 mm × 341 mm
Mass	Approx. 4.8 kg
Operating temperature range	0 °C to 40 °C
Operating humidity range	35 % to 80 % RH (no condensation)

\*1: Wired LAN or Wireless LAN

### ■ AMPLIFIER SECTION

Output power	50 W + 50 W (1 kHz, T.H.D. 1.0 %, 4 Ω, 20 kHz LPF)
Load Impedance	4 Ω - 16 Ω
Frequency Response	
PHONO (MM)	20 Hz - 20 kHz (RIAA DEVIATION ±1dB, 8 Ω)
LINE	20 Hz - 40 kHz (-3 dB, 8 Ω)
DIGITAL	20 Hz - 80 kHz (-3 dB, 8 Ω)
Input sensitivity/ Input impedance	
LINE	650 mV / 31 kΩ
PHONO (MM)	6.5 mV / 47 kΩ

## ■ TUNER SECTION

### Frequency Modulation (FM)

Preset memory	30 stations
Frequency range	87.50 MHz to 108.00 MHz (50 kHz step)
Antenna terminals	75 $\Omega$ (unbalanced)

## DAB

DAB memories	20 channels
Frequency band (wavelength)	Band III (All Band III): 5A to 13F (174.928 MHz to 239.200 MHz)
Sensitivity *BER $4 \times 10^{-4}$	Min requirement: -98 dBm
DAB external antenna terminal	F-Connector (75 $\Omega$ )

## ■ DISC SECTION

Playable Disc (8 cm or 12 cm)	CD, CD-R, CD-RW
Pickup	
Wavelength	790 nm (CD)
Laser power	CLASS 1
Format	CD-DA

## ■ Bluetooth® SECTION

Bluetooth® system specification	Bluetooth® Ver.4.2
Wireless equipment classification	Class 2 (2.5 mW)
Supported profiles	A2DP, AVRCP
Supported codec	AAC, SBC
Frequency band	2.4 GHz band FH-SS
Operating distance	Approx. 10 m Line of sight*2

\*2: Prospective communication distance

Measurement environment:

Temperature 25 °C/Height 1.0 m

Measure in "Mode1" (Emphasis on  
connectivity)

## ■ TERMINALS SECTION

Headphones Jack	Stereo, $\phi$ 3.5 mm
USB	FRONT USB Type A Connector
Support Memory Capacity	2 TB (max)
Maximum number of folders (albums)	800
Maximum number of files (songs)	8000
File system	FAT16, FAT32, NTFS
USB port power	DC OUT 5 V 0.5 A (max)
Ethernet interface	LAN (100BASE-TX/10BASE-T)
Analogue Input	Line input (Pin Jack) PHONO (MM) (Pin Jack)
Analogue Output	Sub Woofer output (Pin Jack)
Digital Input	Optical digital input (Optical terminal) Coaxial digital input (Pin Jack)
Format support	LPCM

## ■ FORMAT SECTION

### USB-A

USB Standard	USB 2.0 High-speed USB Mass Storage class
--------------	--

## ■ Wi-Fi SECTION

Standard	IEEE802.11a / b / g / n / ac
Frequency Band	2.4 GHz band 5 GHz band
Security	WPA2™, Mixed mode WPA2™/ WPA™

- The WLAN feature of this product shall exclusively be used inside buildings.

## ■ File format

This unit supports the following file formats.

- This unit does not support the playback of copy-protected music files.
- Playback of all files in formats supported by this unit is not guaranteed.
- Playback of a file in a format not supported by this unit may cause choppy audio or noise. In such cases, check to see if this unit supports the file format.
- This unit does not support VBR (Variable Bit Rate) playback.
- Some of the connected devices (servers) may be capable of converting files in formats not supported by this unit and output them. For details, refer to the operating instructions for your server.
- File information (sampling frequency, etc.) shown by this unit and playback software may differ from each other.
- Depending on PC, application, etc., the content may not be played back even though the sampling frequency is supported. Check the PC, application, etc., to play back properly.

## USB-A

File format	Extension	Sampling frequency	Bit rate/ Number of quantisation bits
MP3	.mp3	32/44.1/ 48 kHz	16 to 320 kbps
AAC	.m4a .aac	32/44.1/48/ 88.2/96 kHz	16 to 320 kbps
WAV	.wav	32/44.1/48/ 88.2/96/ 176.4/192/ 352.8/384 kHz	16/24/32 bit
FLAC	.flac	32/44.1/48/ 88.2/96/ 176.4/192/ 352.8/384 kHz	16/24 bit
AIFF	.aiff	32/44.1/48/ 88.2/96/ 176.4/192/ 352.8/384 kHz	16/24/32 bit
ALAC	.m4a	32/44.1/48/ 88.2/96/ 176.4/192/ 352.8/384 kHz	16/24 bit
DSD	.dff .dsf	2.8/5.6/ 11.2 MHz	



## LAN (DMR)\*

File format	Extension	Sampling frequency	Bit rate/ Number of quantisation bits
MP3	.mp3	32/44.1/ 48 kHz	16 to 320 kbps
AAC	.m4a .aac	32/44.1/48/ 88.2/96 kHz	16 to 320 kbps
WAV	.wav	32/44.1/48/ 88.2/96/ 176.4/192/ 352.8/384 kHz	16/24/32 bit
FLAC	.flac	32/44.1/48/ 88.2/96/ 176.4/192/ 352.8/384 kHz	16/24 bit
AIFF	.aiff	32/44.1/48/ 88.2/96/ 176.4/192/ 352.8/384 kHz	16/24/32 bit
ALAC	.m4a	32/44.1/48/ 88.2/96/ 176.4/192/ 352.8/384 kHz	16/24 bit
DSD	.dff .dsf	2.8/5.6/ 11.2 MHz	

\*: Whether or not each music file can be played back over your network is determined by the network server even if the format of the file is listed above. For example, if you are using Windows Media Player 11, not all music files on the PC are playable. You can play back only those added to the library of Windows Media Player 11.

### Note

- Specifications are subject to change without notice.
- Mass and dimensions are approximate.

EU



**UK  
CA**

**Importer for UK:  
Panasonic UK, a branch of  
Panasonic Marketing Europe GmbH  
Maxis 2, Western Road, Bracknell,  
Berkshire, RG12 1RT**

**Headquarter Address:  
Panasonic Corporation  
1006 Oaza Kadoma, Kadoma City,  
Osaka 571-8501, Japan**

**Authorized Representative in Europe:  
Panasonic Marketing Europe GmbH  
Panasonic Testing Centre  
Winsbergring 15, 22525 Hamburg,  
Germany**

---

**Panasonic Corporation**

Web Site: <https://www.panasonic.com>

© Panasonic Corporation 2022 - 2024

Ⓔ

TQBM7184-3  
M0222YY2094